



- IHEALTH WIRELESS HEALTH-CARE PRODUCTS 
- DIAGNOSTIC TESTS LABORATORY 
- OPERATOR'S PROTECTION 
- HOLLOWARE - SURGICAL INSTRUMENTS - SYRINGES 
- MEDICAL BAGS 
- SCALES & MEASURES 
- HEALTH CARE PATIENT AIDS 
- FURNITURE 
- PHYSIOTHERAPY NEBULIZERS - SUCTION PUMPS 
- GYNAECOLOGY & PROCTOLOGY 
- CAUTERY & ELECTROSURGERY 
- LOUPES, VISION & ENDOSCOPY 
- MEDICAL LIGHTS 
- DIAGNOSTICS 
- AUDIOMETRY & RESPIRATORY 
- ECG MONITORS & ULTRASOUND 
- FIRST AID PARAMEDICAL - EMERGENCY 
- STERILIZATION 
- VETERINARY 
- HUMAN ANATOMY MODELS 





En **LOMISA** nos centramos en los proyectos con la finalidad de mejorar la eficiencia operativa de un centro de salud. Hacemos frente, junto a nuestros clientes, al reto de modernizar sus instalaciones y servicios, proporcionando tecnologías vanguardistas, procedimientos probados y protocolos clínicos actualizados.

Nuestra visión a largo plazo siempre mejora la calidad de vida de los pacientes, que deberían beneficiarse del uso de las instalaciones y servicios. Mediante una estrecha colaboración con los profesionales y gestores del sector sanitario, proporcionamos planes, proyectos ejecutables y soluciones materiales para alcanzar los objetivos de sus instituciones públicas o privadas.

Al trabajar a nivel de gobiernos o administraciones centrales, también consideramos la oportunidad de reforzar el funcionamiento de la atención primaria para facilitar o ampliar el acceso de la población a los estándares apropiados de cuidado preventivo, diagnóstico y crítico. Nuestra estrategia para lograr esos objetivos es la potenciación de los actores claves, para que hagan lo correcto.

Nuestro equipo incluye a gestores e ingenieros con una gran experiencia en el sector hospitalario, ampliamente cualificados en el uso de la tecnología médica y la gestión de los servicios clínicos, que reciben el apoyo de una extensa red internacional de asesores clínicos de primer nivel para cubrir cualquier especialidad, desde los servicios clínicos centrales del hospital a las terapias modernas y complejas.

En **LOMISA** proporcionamos una amplia gama de servicios (instalación, ajuste, puesta en marcha, formación técnica y al usuario, mantenimiento preventivo y correctivo durante el periodo de garantía o el ciclo de vida útil) al presupuestar todas nuestras soluciones de equipamiento, como parte de nuestro fuerte compromiso con el cliente.

Otros equipamientos que suministramos:

- Anatomía patológica
- Esterilización y desinfección
- Rehabilitación
- Imagenología
- Laboratorio
- Medicina deportiva
- Oncología
- Quirófanos
- Refrigeración



NUESTRAS MARCAS



Furniture

Mobiliario

■ SELECCIONE EL PRODUCTO QUE ESTÁ BUSCANDO

CAMAS Y COLCHONES

CAMILLAS

CARROS

SILLAS Y SILLONES

MESAS

ARMARIOS

CORTINAS

ELEVADORES

SILLAS Y SILLONES ESPECIALES

CAJAS LUMINOSAS

MESAS DE OPERACIONES MECÁNICAS Y SEMIAUTOMÁTICAS

LAVABO (BOMBA)

CAMILLAS DE MASAJE



Mobiliario

RELAXING ARMCHAIR WITH 1 OR 2 ENGINES - MADE IN ITALY



45150
or 45155

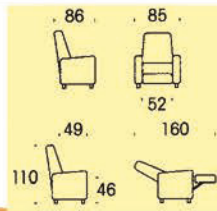

10 COLOURS
AVAILABLE

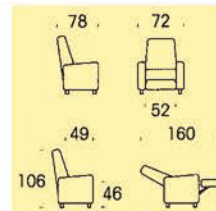

45161
or 45166

RELAXING ARMCHAIRS

Relaxing multifunctional armchair adaptable to any need. 2 models (Beatrice and Betty), 1 or 2 engines and 10 colours. Fabric 100% polyester. Load 120 kg. **One engine:** two button control for synchronized movement of leg section and back.

Two engines: four button control for independent movement of leg section and back. Lift motor 230 V - 50 Hz.

1 engine + lifting up



2 engines + lifting up



| 1 engine | 2 engine | BEATRICE ARMCHAIRS |
|----------|----------|--------------------------------|
| 45150 | 45155 | Beatrice - colour on request** |
| 45151 | 45156 | Beatrice - beige 2 |

**Product available in 15-20 days

| 1 engine | 2 engine | BEATRICE ARMCHAIRS |
|----------|----------|-----------------------------|
| 45160 | 45165 | Betty - colour on request** |
| 45161 | 45166 | Betty - blue 11 |

INVALID RINGS



28611

Quality invalid rings made of latex-free rubber. Internal hole Ø 14 cm.



28614

| GIMA code | INVALID RUBBER RINGS LATEX - FREE |
|-----------|-----------------------------------|
| 28610 | Invalid ring Ø 35 cm |
| 28611 | Invalid ring Ø 40 cm |
| 28612 | Invalid ring Ø 45 cm |
| 28614 | Pump for invalid ring |

BED-TRAYS - FOLDING LEGS

Bed-trays with anti-scratch surface and containing edge. Folding legs. Size: 60x40x24 cm. Made in Italy.

- 44750 BED TRAY - white
- 44753 SERVOPLUS BED TRAY - 3 position - walnut



44750

Weight: 2.75 kg



44753

Weight: 3.2 kg
Bed tray/bookrest tilting in 3 positions.

DINING TABLE



Size: 110x42x93 cm

27449

• **27449 DINING TABLE**
Patient dining table with polished aluminium tubular structure. White laminated wooden top, easy to clean, with anti-shock rubber PVC band. It is mounted on two rubber feet and two plastic wheels Ø 40 mm to allow movability and comfortable use. Delivered in kit form. Made in Italy.

OVERBED TABLES



Adjustable height:
76 to 113 cm

27458

Size: 70x44xh 76/113 cm

• **27458 OVERBED TABLE - moulded shelf**
Chrome plated/epoxy glass finish square steel tube. Tiltable and sliding serving tray made of thermoformed anti-shock plastic material with retaining edges and pre-formed bottle, glass and cutlery holder. Base with 4 Ø 50 mm castors (2 with brake). Delivered in kit form. Made in Italy.



Adjustable height:
72 to 110 cm

• **27448 OVERBED TABLE**
Overbed table with steel frame and high density board. Base with 4 Ø 50 mm (2.5") removable castors (2 with brake). Adjustable height and angle. Board size: 41x61 cm. Carton size: 65x7x67 cm. Delivered in kit form.



Set into the panel



Lock and adjustable panel



Adjustable height

HYDRAULIC AND ELECTRICAL LIFTERS



• **27749 HYDRAULIC LIFTER - max load 200 kg**
Lifting movement through a hydraulic pump operated by adjustable side control lever. Descent movement by independent exhaust-valve. Adjustable base 68 to 118 cm controlled by a manual device for an easy access to narrow places. Painted steel frame. Anti trauma push-handle. 2 rear castors Ø 100 mm, with independent brake and 2 front castors Ø 70 mm. Equipped with sling with head support (27754). Made in Italy.

- **27752 ELECTRICAL LIFTER 170 - max load 170 kg**
- **27753 ELECTRICAL LIFTER 200 - max load 200 kg**
Same as code 27749 but with electrical controls. Up and down movements through an electric motor 24V D.C. and push button. Battery fed with current transformer with an emergency push-button for the immediate stop of the movement and free up/down piston-stroke. Supplied with universal sling (27752) or sling with head support (27753).
- **27757 UNIVERSAL SLING - spare - load 170 kg**
- **27754 SLING with head support - spare - load 250 kg**
Mesh fabric sling.



LIFTING STAND



• **27645 LIFTING STAND**
Tubular painted steel frame with adjustable chromed steel joint. Can be fully disassembled to reduce size. Three main height adjustments. Triangle hangs from belt with adjustable length.

SHOWER MATTRESS

• 27836 SHOWER MATTRESS

It allows bed-ridden, elderly or disabled patients to be washed and cared for in their personal hygiene with running water directly on their bed, without any need for transfer/lift. Inside the "Shower Mattress", the patient can be showered with water coming from the tap via an extension hose or using the special pressurized water tank provided with flexible hose and shower head.

Once finished, the water is drained into a suitable container. Complete with plug and flexible hose for quick water drain.

• 27837 WATER TANK - 10 l

Pressurized water tank complete with flexible hose 4 m and shower head operated by button.

• 27838 SHOWER EXTENSION HOSE

Flexible, 6 m hose complete with button-operated shower head and tap adapter.



SHOWER TROLLEY - HYDRAULIC OR ELECTRIC HEIGHT ADJUSTMENT

• 44770 SHOWER TROLLEY - hydraulic

Shower stretcher can be used for both transport and showering, and is the ideal solution for treatment of patients in assisted baths of hospitalization or retirement home.

Easy to move thanks to rubber castors with individual brake and one with directional lock to facilitate transport in long linear path.

Automatic progressive tilting to allow a gradual water drainage.

Safety side rails with one-hand folding/locking system. Supplied with PCM foam padded waterproof mattress made with fire-resistant auto-extinguishing Class 2 PVC, trapezoidal pillow, same specifications as mattress, and extendable and flexible drain hose (Ø 40 mm - length 1.5 m).

• 44771 SHOWER TROLLEY - electric

Same as 44770 but with electric lifting system (Linak actuator, 6,000N, DC 24 V, 4.5 A).

IP x 5 control box with emergency stop.

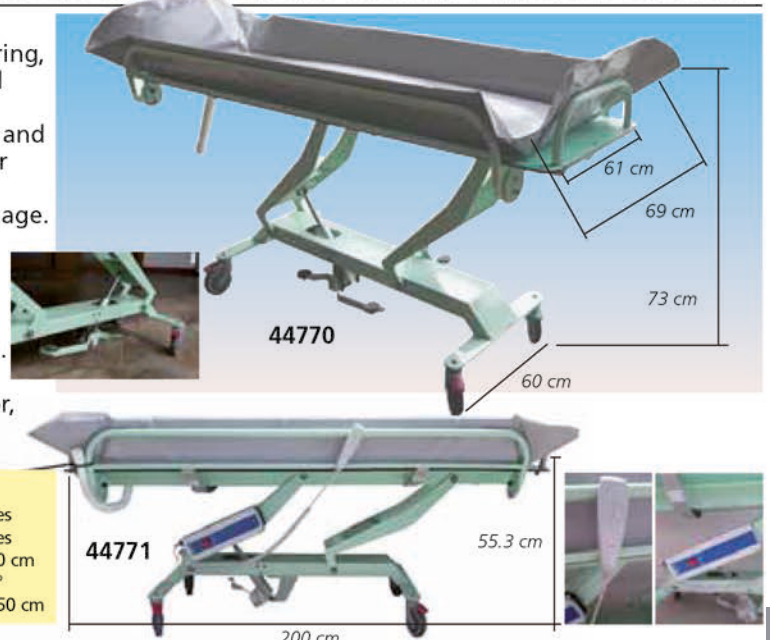

TECHNICAL SPECIFICATIONS

| | | | |
|------------------------|------------------------------|----------------------------|--------|
| Max working load: | 190 kg | Directional system: | yes |
| Weight: | 93 kg | Collapsible head end rail: | yes |
| Size: | 2,000 x 746 x h 753/1,108 mm | Mattress height: | 20 cm |
| Castor diameter: | 12.5 cm | Tilt for water discharge: | 7° |
| Castor braking system: | Individual on each castor | Discharge hose length: | 150 cm |

MATTRESSES, COVERS AND PILLOWS



27680

- 27690 MATTRESS 190x80x12 cm
 - 27680 MATTRESS 195x85x14 cm
- Polyurethane foam mattresses, density 30 kg/mc
- 27693 100% COTTON COVER FOR MATTRESS 27690

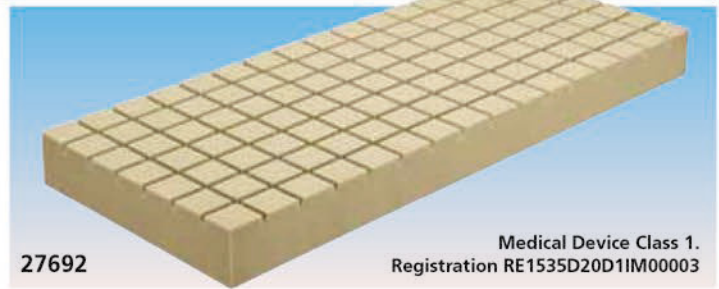

27692

Medical Device Class 1.
Registration RE1535D20D1IM00003

- 27692 DAMA MATTRESS 195x85x14 cm
- Expanded polyurethane mattress, density 30 kg/mc. Fire proof and latex free. Antibacterial, hypoallergenic and antifungal. Autoclavable at 135 °C.

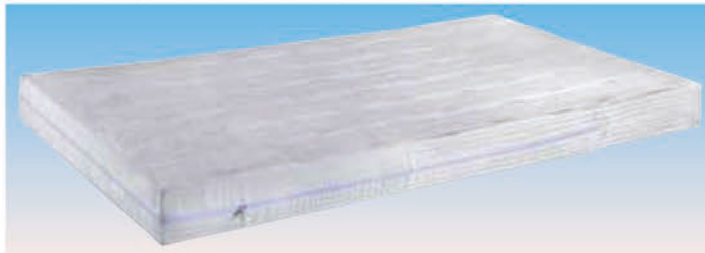

- 27682 MATTRESS WITH COVER 195x85x14 cm
- Polyurethane foam mattress, density 30 kg/mc with flame retardant, 100% breathable polyester cover. Class 1



Medical Device Class 1IM.
Registration RE1535D20D1IM00008

- 44804 HNF MATTRESS WITH COVER 195x85x14 cm
- Polyurethane foam mattress, density 35 kg/mc. Non deformable, antibacterial, antifungal and autoclavable at 135°C. Supplied with TEKMA polyurethane cover with zip fastener.

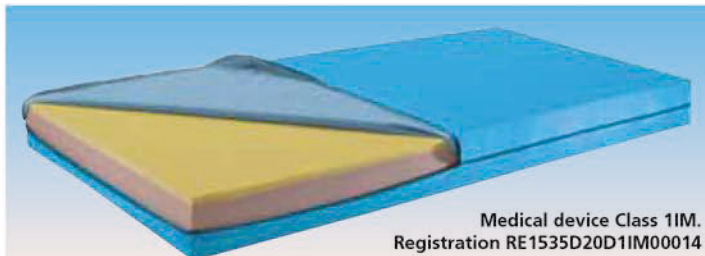

Medical device Class 1IM.
Registration RE1535D20D1IM00014

- 44806 AMYLIFE MATTRESS WITH COVER 195x85x14 cm
- Mattress with polyurethane foam base and viscoelastic high density top. Density 35 kg/mc (base), 60 kg/mc (top). Non deformable, antibacterial, antifungal and autoclavable. Supplied with TEKMA polyurethane cover with zip fastener.

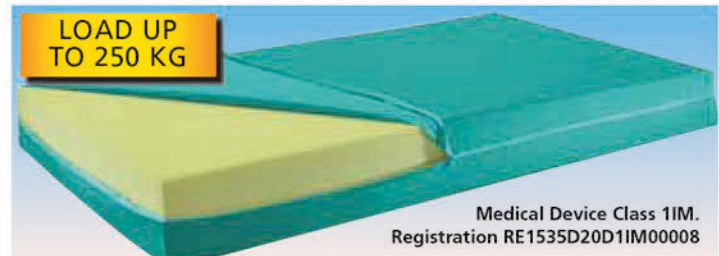

Medical Device Class 1IM.
Registration RE1535D20D1IM00008

- 44803 MATTRESS WITH COVER 195x85x18 cm
- Polyurethane foam mattress, density 35 kg/mc. Non deformable, antibacterial, antifungal and autoclavable at 135°C. Supplied with TEKMA polyurethane cover with zip fastener.



Class 1IM.
Registration RE1535D20D1IM00001

- 27696 PILLOW 45x75x10 cm
- Polyurethane foam, transpirant, pillow, density 21 kg/mc with polyester, fire retardant, cover. Washable at 95°C, autoclavable.



Class 1IM.
Registration VA735D1IM00014

- 44812 SWEET DREAM PILLOW 50x80x18 cm
- Polyester padding and polyester cover washable at 40°C. Fire retardant.



Class 1

- 27681 POLYESTER COVER 195x85x14 cm - white
- Transpirant polyester fireproof cover for mattresses (27680, 27682, 27692)



Class 1

- 27695 TEKMA POLYURETHANE COVER - 195x85x18 cm - white
- Soft, fire retardant, transpirant and waterproof cover. Universal (up to h14 cm) with elastic. Washable. Autoclavable at 134°C.

BACKREST



- 44825 BACKREST - blue
- Painted steel tubular frame. Adjustable in 5 positions .

COVER LIFTER

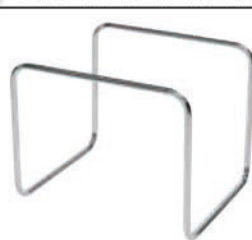

- 27642 COVER LIFTER
- Chromed steel tubular frame. Can be disassembled.

A4 AND A3 RECORD HOLDERS



- 27647 A4 INOX RECORD HOLDER 37x25x5 cm
- 44820 A4 PVC WHITE RECORD HOLDER 24x32 cm
- 44821 A3 PVC WHITE RECORD HOLDER 43x32 cm

Universal hook to fit any bed frame

Privacy system: non visible patient file

HOSPITAL BEDS



27841 Height adjustable 160 to 245 cm



Lifting pole Code 27644 (not included)



27610 + accessories

Collapsible support code 27641 (not included)



27646

BED WITH ADJUSTABLE HEAD SECTION

- 27600 BED WITH 1 ARTICULATION
- 27601 BED WITH 1 ARTICULATION - with wheels

Painted steel frame with net.
 1 Pipe frame with net for head movement, 200x85 cm.
 2 Heads in chromed pipe complete with MDF bilaminated coated panel. Movement by a crank. Protection of end run. Rubber wheels of Ø 100 mm, with brakes (only for code 27601)
 Size: 206x89xh 90 cm. Height of frame from bottom 52/55 cm.
 Size of frame: 200x85 cm. Weight 32 kg.
 Made in Italy

BED WITH ADJUSTABLE HEAD AND FOOT SECTION

- 27610 BED WITH 3 ARTICULATIONS
- 27611 BED WITH 3 ARTICULATIONS - with wheels

Painted steel frame with net.
 3 bed frames with nets in painted steel pipe, 200x85 cm.
 2 Heads in chromed pipe complete with MDF bilaminated coated panel. Movement by 2 cranks. Protection of end run. Rubber wheels of Ø 100 mm, two of which with brake (only 27611)
 Size 206x89xh 90 cm. Height of frame from bottom 52/55 cm.
 Size of frame: 200x85 cm.
 Weight 42 kg. Made in Italy



27605



27608

- 27605 STANDARD BED - no castors
 - 27606 STANDARD BED - Ø 50 mm castors
 - 27607 STANDARD PLUS BED - no castors
 - 27608 STANDARD PLUS BED - Ø 100 mm castors
- Simple bed made of epoxy - coated steel. Head and foot ends with plastic feet. Rigid mesh mattress platform.
- 27607 STANDARD PLUS BED - no castors
 - 27608 STANDARD PLUS BED - Ø 100 mm castors
- Chrome-plated steel bed ends. Laminated plastic panels. Rigid mesh mattress platform. Adjustable back-rest
 Size: 206x89xh 90 cm. Made in Italy.
- 27841 I.V. STAND - 5 wheels trolley

| code | ACCESSORIES FOR ALL BEDS |
|-------|---|
| 27641 | Collapsible supports (for all types of bed) |
| 27644 | Lifting pole |
| 27646 | 4 Hook IV stand for bed - stainless steel |

BEDSIDE TABLES - MADE IN ITALY



27665

Size: 42x40xh 83 cm



27669

Size: 42x40xh 83 cm



27674

Size: 42x40xh 80 cm



27662

Size: 42x52.5xh 80 cm



27679

Four revolving castors Ø 60 mm (2 with brake) with bumpers Ø 100 mm.



27678

DOUBLE FACE

BEDSIDE TABLES

Epoxy powder coated steel sheet tube or body.
 Thermoformed ABS top and drawer. Laminated plastic drawer face and door (27665 and 27666 only) 10 mm thick. Bedside table with door has inner removable shelf and is available in left (L) or right (R) version.

- 27669 BEDSIDE TABLE WITH DRAWER
- 27665 BEDSIDE TABLE WITH DRAWER AND LEFT DOOR
- 27666 BEDSIDE TABLE WITH DRAWER AND RIGHT DOOR

FEBO BEDSIDE TABLES

Epoxy powder coated steel sheet 8/10 body. Towel holder and lateral bottle holder (27662 only). Soft rubber antitrauma handle. Sliding drawer with removable ABS tray. Inner removable shelf. 4 revolving castors (2 with brake)

- 27674 FEBO BEDSIDE TABLE - blue avio RAL 5014
- 27675 FEBO BEDSIDE TABLE - other colours*

| | | | | |
|----------|----------|----------|----------|----------|
| RAL 5010 | RAL 2003 | RAL 6019 | RAL 1013 | RAL 7040 |
|----------|----------|----------|----------|----------|

*Available in 30 days. Minimum order 10 pcs.

- 27662 FEBO BEDSIDE TABLE WITH BOTTLE HOLDER - blue avio RAL 5014

BEDSIDE TABLE WITH DRAWER, DOOR, BOTTLE - GLASS HOLDER, OVERBED TABLE

Epoxy powder coated steel sheet body. Thermoformed ABS top with towel holder, lateral bottle and glass holder. Sliding drawer with removable ABS tray. Laminated plastic drawer face and door 10 mm thick. Anti-trauma handles. Revolving, extensible, adjustable height cm 90/110 ABS overbed table top. Removable inner shelf. Plastic grid at bottom.

- 27678 BEDSIDE TABLE - DOUBLE FACE
- 27679 BEDSIDE TABLE - SINGLE FACE

PATIENT BEDS WITH 1 OR 3 JOINTS, MANUAL OR ELECTRIC

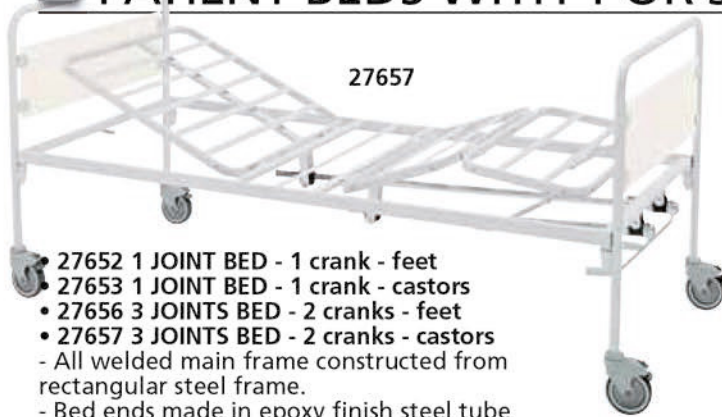

27657

- 27652 1 JOINT BED - 1 crank - feet
- 27653 1 JOINT BED - 1 crank - castors
- 27656 3 JOINTS BED - 2 cranks - feet
- 27657 3 JOINTS BED - 2 cranks - castors
- All welded main frame constructed from rectangular steel frame.
- Bed ends made in epoxy finish steel tube
- 1 joint/2 sections or 3 joints/4 sections
- manual movement by 1 or 2 cranks with retractable handles
- legs fitted with 4 revolving directional rubber/steel castors with independent brake or plastic feet.

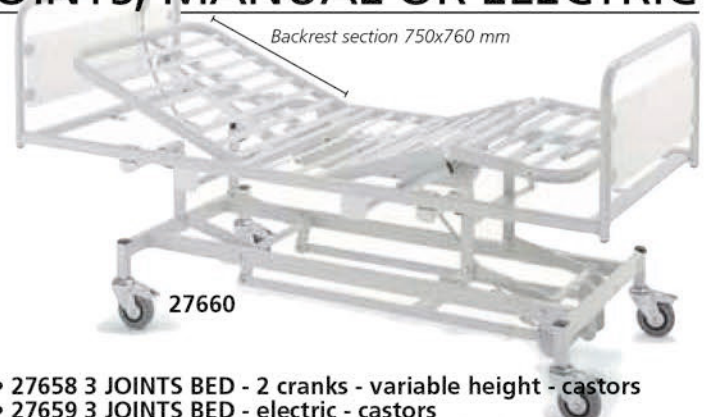

27660

- 27658 3 JOINTS BED - 2 cranks - variable height - castors
- 27659 3 JOINTS BED - electric - castors
- 27660 3 JOINTS BED - electric - variable height - castors
- 3 joints/4 sections beds adjustable by means of 2 independent cranks (27658) or electric motor 24 V DC and push button
- height adjustable by hydraulic foot pump (27658) or electric motor (27659/60)
- Legs and other features as 27652

TECHNICAL SPECIFICATIONS

| | 27652/3 | 27656/7 | 27658 | 27659 | 27660 |
|------------------------|---------------|----------|---------------|----------|----------|
| Size of platform: | 900x2,000 mm | | | | |
| Platform height mm: | 475 | 475 | 400/800 | 475 | 400/800 |
| Height of bed ends mm: | 950 | | | | |
| External measurement: | 910x2,060 mm | | | | |
| Packing size mm: | 960x145x2,070 | | 960x220x2,070 | | |
| Movement: | 1 crank | 2 cranks | 2 cranks | electric | electric |
| Max patient load kg: | 135 | | | | |



27652

27659



27663
Collapsible support

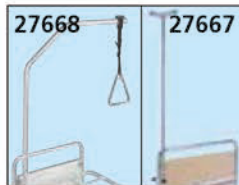

27668 27667
Infusion pole and lifting pole

ACCESSORIES FOR PATIENTS BEDS

| GIMA code | ACCESSORIES FOR PATIENTS BEDS |
|-----------|---------------------------------------|
| 27663 | Collapsible support - couple |
| 27667 | Infusion pole with universal clamp |
| 27668 | Lifting pole with slot in system |
| 27661 | Kit for castors spare for 27658/59/60 |

SPECIALISTIC BED 3-JOINTS/4 SECTIONS, ELECTRICAL, ADJUST. HEIGHT



Height adjustment of platform from ground from 40 to 80 cm (27673) or 23 to 63 cm (27672)

Possibility of Trendelenburg (12°) and reverse-Trendelenburg (12°) movements



27673

- 27673 SPECIALISTIC BED with Trendelenburg - 40-80 cm
- 27672 SPECIALISTIC LOW BED with Trendelenburg - 23-63 cm
- Three-joints, four sections bed with adjustable height from 40 to 80 cm or 23-63 cm with full electrical movements.
- All welded mainframe made of rectangular steel tube 50x25x2 mm.
- Mattress platform with flexible wooden staves, complete with mattress-hold guides. Backrest-section and leg-section adjustable by means of two independent electric motors 24V D.C. and push-button.
- Foot-section adjustable by means of a rack device. Fixed pelvis-section.
- Removable head and foot-end frames made of natural beech finish wood with solid corners and edges.
- Comes complete with 2 vertical sliding bars with upper/lower lock/unlock keys and lifting pole.
- Legs fitted with 4 castors Ø 100 mm with independent brake.

TECHNICAL SPECIFICATIONS

| | |
|---|--|
| Size of platform: | 900x2,000 mm |
| Platform height: | 400-800 mm (27673) 230-630 mm (27672) |
| External measurement: | 1,030x2,140 mm |
| Height of bed end from mattress platform: | 50 mm |
| Max load: | 135 kg |
| Weight: | 102 kg |
| Operating power: | 230 V - 50 Hz |

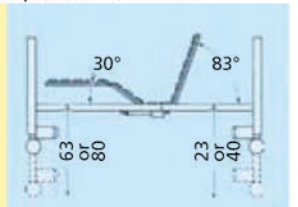

27672

QUALITY
EN 1970:2000
DIN EN 1970:2000-12
EN 60601-2-38:2001
DIN EN 60601-2-52:2009



27676

27677

- 27676 WOODEN BEDSIDE TABLE - height adjustable, tiltable tray
Manufactured by quality laminated wooden panel. Particularly functional: with drawer, 2 doors (can be used from both sides) and lateral height adjustable (73-100 cm) tiltable tray at 90° (27676) or swing type tray (27677).
- Size: 50x33xh 85 cm. Lateral tray: 58x33 cm (27676), 72x36 cm (27677).
- 4 revolving castors (2 lockable). ABS border.
- 27677 WOODEN BEDSIDE TABLE - extractable tray

I.V. STANDS

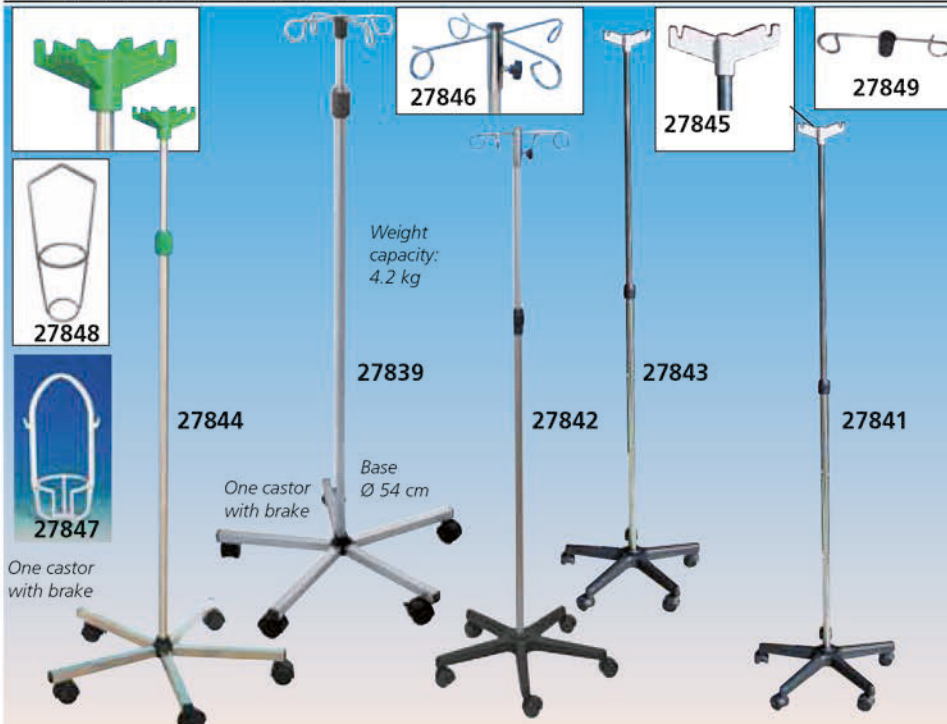

| GIMA code | N | Hook Material | Stand Material | Adjustable height | Base Material | Weight kg |
|-----------|---|-----------------|---|-------------------|-----------------|-----------|
| 27839 | 4 | Stainless steel | Stainless steel AISI 304 | 160-220 cm | Stainless steel | 3.3 |
| 27841* | 2 | plastic | Chromed-steel | 160-245 cm | plastic | 2.9 |
| 27842* | 4 | metal | Chromed-steel | 160-245 cm | plastic | 3.2 |
| 27843* | 2 | plastic | Aluminium | 158-248 cm | plastic | 2.9 |
| 27844 | 4 | plastic | Stainless steel AISI 304 | 160-220 cm | Stainless steel | 2.9 |
| 27845 | 2 | plastic | Plastic support for bottle holder - load 1 kg each hook | | | |
| 27846 | 4 | metal | Metal support for bottle holder - load 1 kg each hook | | | |
| 27849 | 2 | Stainless steel | Stainless steel AISI 304 support for bottles holder | | | |
| 27847 | - | | Plastic bottle holder - box of 40 pcs. | | | |
| 27848 | | | Stainless steel AISI 304 bottle holder. Capacity 2.5 kg | | | |

*Maximum load 2 kg each hook

HYPODERMOCLYSIS STAND



4 stainless steel AISI 304 hooks, with anti-release safety device

Stand Ø 60 mm

LOAD CAPACITY 28 KG

Stainless steel adjustable gripping handle for easy transport

Pedal driven shock absorbing pump. Height adjustable: 195-291 cm Weight: 26 kg

Stainless steel base with 5 pivoting castors Ø 60 mm (1 antistatic, 2 with brake, 2 standard) and grey vipla bumpers.

• **27856 HYPODERMOCLYSIS STAND**
Stand with hydraulic height adjustment for hypodermoclysis, for washing and surgical irrigation. Hydraulic pump with pedal for height adjustment and gripping handle for easy transport. Made in Italy.

SWADDLING TABLE

• **27400 SWADDLING TABLE** - beige Baby changing table with Itallumag tubular frame with 2 shelves. Padded worktop 115x60 cm in soft washable fireproof (Class 1 IM) simulated leather and lower shelf 100x40 cm, in laminated chipboard panel. Max load: 60 kg Size: 115x63xh 85 cm Weight: 28 kg Delivered disassembled. Made in Italy.



27400

NEONATAL CRADLE

• **43500 NEONATAL CRADLE** with trolley Transparent unbreakable plastic cradle with round edges and ventilation holes. Epoxy powder painted mainframe made of curved and welded tubular steel. Shape of trolley allows horizontal and Trendelenburg inclinations and bedside positioning. Legs fitted with 4 synthetic rubber castors Ø 75 mm, two with brake. Dimensions: 83.5x52.5xh 90 cm. Weight: 15 kg. Max load: 10 kg. Delivered disassembled. Made in Italy.

- **43501 CRADLE** - spare
- **27685 MATTRESS** 63x37x5.5 cm - fireproof
- **27686 COVER** - water proof

Manual: GB, FR, IT, ES



43500

PEDIATRIC BED

• **27399 PAEDIATRIC BED** 1-4 years 200°C epoxy powder painted mainframe made of steel tube Ø 30 mm, ready to be hooked into the mattress platform. Mesh mattress platform made of oval tube 40x20 mm, fixed to the mainframe with removable bolts. Side rails 62 cm h. sliding on chromed steel guides, with safety device. Legs with 4 castors Ø 80 mm, two with brake. Weight 35 kg. External measurement 140x70xh 130 cm Inner size 130x65xh 63 cm. Made in Italy.



27399

Colour: ivory (RAL 1013)

• **27687 MATTRESS** 125x62x10 cm - fireproof
• **27688 COVER** - water proof

AN INTEGRATED SYSTEM OF TREVIRA® CURTAINS

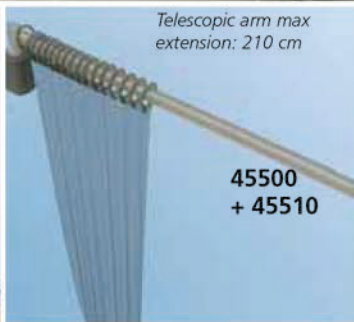

A COMPLETE SEPARATION SYSTEM

A complete system to create separations inside hospital rooms or outpatient wards.

System includes

4 STRUCTURES - include rings

- window curtain rails
- cabin curtain rail
- adjustable wall arms
- trolleys with 1 or 2 curtains

3 SIZES TREVIRA® CURTAINS IN 6 COLOURS - do not include rings

Window curtain rails

Available in 2 sizes: 160 cm (45492) need curtains 175xh 145 cm and 210 cm (45493) need curtains 225x145 cm

Cabin curtain rails

Size: 80x80 cm, need curtain 225xh 180 cm

Swing arm curtains - manual or electrical

Swing arm curtain is adjustable horizontally (180°) and can be bent down to 90° (45501 only) when not in use.

Telescopic tubular arm extension: open 210 cm, closed 88 cm (45500 and 45503) or 100 cm (45501).

Rings allow curtains to slide smoothly.

Trolley curtains - 1 or 2 curtains

Trolley made of stainless steel AISI 304 with 4 revolving castors (2 lockable). It allows the use of 1 curtain 225xh 145 cm (45505) or 2 curtains (45506), 1 long 225xh 145 cm and 1 short 175xh 145 cm. Arm can be bent down to 90° when not in use and curtain remains tied up.

| code | STRUCTURE: ARM OR TROLLEY WITHOUT CURTAINS |
|-------|--|
| 45492 | Window curtain rail 160 cm |
| 45493 | Window curtain rail 210 cm |
| 45495 | Cabin rail 80x80 cm |
| 45500 | Adjustable arm |
| 45501 | Adjustable foldable arm |
| 45503 | Electric adjustable arm* |
| 45505 | Trolley for 1 curtain - foldable |
| 45506 | Trolley for 2 curtains - foldable |

*Adjustable horizontally (180°) by electrical control

Trevira® curtains

Trevira® curtains are flame-proof (Class I), antiallergic, avoid bacterial growth, waterproof and highly resistant to abrasion.

Thick weft to avoid dust infiltration and improve privacy, washable up to 60°C. Available in 6 colours to match any need.

Custom-made curtains are available on request. Made in Italy.



| TREVIRA CURTAINS | | | |
|-------------------------|------------------------------------|-------------------------------------|------------|
| FOR WALL ARMS AND CABIN | FOR TROLLEYS AND WINDOWS | | COLOUR |
| 225xh 180 cm | Long trolley arm/rail: 225xh145 cm | Short trolley arm/rail: 175xh145 cm | |
| 45510 | 45520 | 45530 | Light blue |
| 45511 | 45521 | 45531 | Blue |
| 45512 | 45522 | 45532 | White |
| 45513 | - | - | Beige |
| 45514 | - | - | Green |
| 45515 | 45525 | 45535 | Peach |

| SET OF 18 RINGS - SPARE | |
|-------------------------|---|
| 45508 | Open rings for window rails and cabin |
| 45509 | Closed rings for wall arms and trolleys |



PATIENT TROLLEYS - STRETCHERS



27801



- 27800 PATIENT TROLLEY
 - 27801 PATIENT TROLLEY - removable top
- Made of chrome plated steel tube. Comes complete with mattress made in washable self extinguishing plastic material. Mounted on 4 castors Ø 100 mm two of which with brakes. Size: 180x54xh 80 cm. Load: 100 kg. Made in Italy.

| code | PATIENT TROLLEY ACCESSORIES - not included |
|-------|--|
| 27810 | Side rails (couple) |
| 27811 | I.V. Stands |
| 27812 | Steel basket |
| 27813 | Oxygen bottle holder |

PROFESSIONAL WARD STRETCHER



44760 + accessories (not included)

- 44760 WARD STRETCHER
- Main features:
- **Platform:** all-welded mainframe made of semi-oval steel tube 50x25x2 mm.
 - **Push/Pull handle:** Made in steel tube Ø 30x1.5 mm.
 - **Surface finish:** Epoxy gloss finish standard grey 7040
 - **Mattress platform section:** Two section mattress platform fitted with removable chrome-plated grids made of 5 mm. Ø steel rods and square mesh 50x50 mm.
 - **Backrest:** Square cross section 25x25x1.5 mm, adjustable by means of a rack device (5 positions).
 - **Castors** - Four castors Ø 200 mm made of grey synthetic rubber two of which with independent brake.
 - **Bumpers:** Four bumpers at the corners made of anti-acid and anti-shock grey resin. Supplied disassembled.
- External size: 202x71xh 90 cm
Wired net height: 78 cm
Load: 135 kg.
Manual: GB, FR, IT, ES, PT.
Made in Italy.



| GIMA code | WARD STRETCHER ACCESSORIES - not included |
|-----------|--|
| 44761 | Side rails (couple) with automatic locking device |
| 44762 | I.V. Stand with two hooks |
| 44763 | Basket - chrome plated steel |
| 44764 | Oxygen bottle holder* - chrome plated steel |
| 44765 | Fireproof simulated leather mattress - class I - 182x64x4 cm |

* for oxygen bottle up to 41 cm, Ø 15,5 cm

PROFESSIONAL PATIENT TROLLEY - ADJUSTABLE HEAD SECTION

- 27804 PROFESSIONAL PATIENT TROLLEY with adjustable head section, side rails and oxygen cylinder holder
 - 27805 PROFESSIONAL PATIENT TROLLEY - RADIOTRANSSPARENT FRAME with adjustable head section, side rails and oxygen cylinder holder
- Innovative, stylish comfortable trolley easy to use. Trolley made in sturdy tubular frame for optimal stability. Supplied with 4 wheels Ø 200 mm (2 with brake), bumpers, push handle. Detachable frame with adjustable head section (27804) or fixed frame, 12 mm thickness, with adjustable head section (27805).
Size: 196x76xh 75 cm. Net size: 193x68 cm
Maximum load: 200 kg.
Weight: 70 kg.
Made in Italy.
- 27807 MATTRESS - 186x68xh 8 cm - black Simulated leather. Fire retardant. Class I IM.
 - 27808 IV STAND with 2 plastic hooks.



Position of vertical columns and radiotransparent frame (only 27805) allow the structure to have a wide radiotransparent surface.



ADJUSTABLE HEIGHT PATIENT TROLLEY WITH TR AND RTR

- **27806 PATIENT TROLLEY - with adjustable height, TR and RTR**
Stilish sturdy and comfortable trolley with innovative design allowing operators to easily treat patients. Adjustable in height by means of hydraulic pump with pedal placed on both sides. The lateral sides are very comfortable, easy and fast to fold. The upper wire mesh is removable to guarantee a better hygiene. Equipped with push handles, 4 bumpers at the corners and a universal hold-cylinder. Reclinable cushion thanks to two racks that can be easily actuated by the grip handle. Wheels: 200 cm diam. with total and simultaneous central brake; one of 4 wheels is equipped with directional brake; their activation is made by means of 4 lateral pedals. The joints of the structure rotate on self-lubricating sintered threaded inserts. The trolley can reach the Trendelenburg and anti-Trendelenburg position very quickly thanks to a handle placed on the upper lateral side: it activates a gas spring (600N) that offers millimetric adjustability. The entire structure made in rectangular and round tubular is epoxy painted in grey and white colour. Size: 201x76xh 52/87 cm (without mattress). Load: 130 kg. Weight: 90 kg
- **27807 MATTRESS - 186x68xh 8 cm - black**
Simulated leather, fire retardant. Class 1M
- **27808 IV STAND**



27806

27806 +
2780727806 +
27807

PROFESSIONAL PATIENT TROLLEYS WITH ADJUSTABLE BACKREST

- **27827 PROFESSIONAL PATIENT TROLLEY - with adjustable backrest and side rails**
Trolley made of anodized aluminium with steel perimetral frame with rigid PVC profile. Coated with epoxy powder RAL 1013 ivory. Rigid mattress platform made of powder coated steel welded mesh. Main frame, side rails and shove handle bar made of anodized aluminium. Nylon components with handle shape. Swivelling castors Ø 200 mm, 2 of which with brake. Delivered in kit from. Made in Italy.
- **27830 IV STAND - fixed height 100 cm - 2 plastic hooks**
- **27831 STEEL BASKET - 56x38xh 9 cm**
- **27832 OXYGEN BOTTLE HOLDER - Ø 18x37 cm**
- **27834 FIRE RETARDANT MATTRESS 7 cm - black - 185x58xh 7 cm**



27827

Overall size: 202x76x75 h cm
Mattres platform size: 190x160x75 h cm
Weight: 47 kg - Shipping volume 0.30 m³ - Load: 120 kg

ADJUSTABLE HEIGHT PATIENT TROLLEY WITH TR AND RTR

- **27828 ADJUSTABLE HEIGHT PATIENT TROLLEY with Trendelenburg (TR), Reverse Trendelenburg (RTR) and side rails.** Platform composed by two epoxy powder coated steel RAL 1013 ivory welded mesh sections, detachable for cleaning, fitted on nylon supports and placed on steel crossbar covered with rigid PVC profile. Raising and lowering by gas spring with lever set on the same section. Trolley structure with a rounded section profile coated with epoxy powder RAL 1013 ivory. Adjustable height by oleodinamic pump from 50 cm to 80 cm with foot control lever. TR-RTR position controlled by handle at the foot of the trolley. Mechanical braking. Inclination and platform check by a level bubble. TR 14° RTR 11°. Swivelling castors Ø 200 mm, one of which directional. Simultaneous braking with foot control lever with 3 positions: total brake, swivelling total, swivelling and directional. Made in Italy.
- **27830 IV STAND - fixed height 100 cm - 2 plastic hooks**
- **27833 OXYGEN CYLINDER HOLDER (max. 7 l) and WIRE BASKET - multifunction**
- **27835 FIRE RETARDANT MATTRESS 10 cm - 2 sections - 185x58xh 10 cm**

Easy and fast lock of IV stand
at main frame 4 corners



27828

Overall size: 202x76x75 h cm
Mattres platform size: 190x60x50/80 h cm
Weight: 88 kg - Shipping volume 0.65 m³
Load: 120 kg

TRENDELENBURG PATIENT TROLLEY - STRETCHER

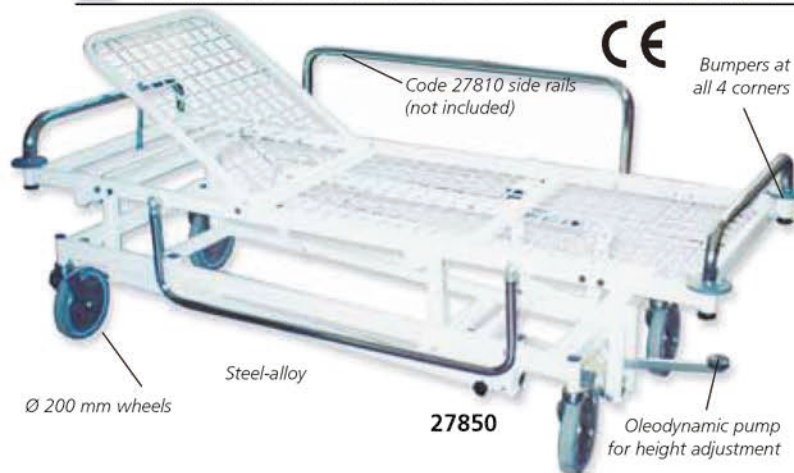

• **27850 TRENDELENBURG TROLLEY**
 Made of steel-alloy, oven painted ral 9010, with chrome plated handles.
 Adjustable height from 50 to 70 cm, with oleodynamic pump.
 Trendelenburg up to 9°.
 Anti-Trendelenburg up to 14° (with gas pump).
 Plastic bumpers at four corners. Maximum load: 120 kg.
 4 wheels of Ø 200 mm (2 with brake).
 Size: 65x184 (internal) x h 50-70 cm, 72x191 cm (external).

| code | ACCESSORIES |
|-------|---|
| 27810 | Side rails (couple) 100xh 28 cm |
| 27853 | I. V. Stands |
| 27854 | Oxygen bottle holder |
| 27855 | Mattress - black sky 3 cm thick in flame retardant material - 184x64x3 cm |

HEIGHT ADJUST. ELECTRIC BED



4 containing sector side rails, made in technopolymer, and single collapsible

Compartments for patient lift bar and IV probe

Size: 110x225xh 91 cm

Bed weight 130 kg

4 castors Ø 150 mm with central brake system with directional control

Moulded removable head and foot boards with integrated handle useful for movements

• **44800 HEIGHT ADJUSTABLE ELECTRIC BED**
 3 joint, 4 section Hospital bed, with electronic adjustment of height and platform, Trendelenburg and Reverse Trendelenburg positions (15°). All steel components are epoxy-coated with anti-microbial additive. Back section regulation using electric actuators with anti-crushing and rototranslation function to avoid abdominal crushing. Both bed sides have CPR manual levers for emergency manoeuvres. Foot rest adjustment by click mechanisms allowing 6 positions. Internal side rails controls for patient use and caregiver. Remote control to maintain position or disable by magnetic key. The keypad allows adjustment of backrest, bed surface height, legs and foot rest, comfort position, Trendel and reverse Trendel.

- **44801 LIFTING POLE**
- **44802 IV POLE**
- **44803 FLAME RETARDANT MATTRESS with waterproof cover** Load 280 kg. Density 35 kg/m². Size 85x195x18 cm.

| TECHNICAL SPECIFICATIONS | |
|--------------------------------------|---|
| Minimum/maximum height surface: | 380-780 mm |
| Maximum backrest regulation: | 70° |
| Maximum leg/foot height regulation: | 30° |
| Trendelenburg/reverse trendelenburg: | 15° |
| Minimum/maximum height: | 835-1235 mm |
| Maximum total width/length: | 1010/2260 mm (bumpers and siderails included) |
| Worksurface width/length dimension | 880/2000 mm |
| Power supply: | 160-230 V - 50-60 Hz |
| Dynamic lift capacity: | 230 kg |
| SWL: | 270 kg |
| IEC protection class: | I / B |
| IP code (protection rating): | IP66 |
| Made in | Italy |

BARIATRIC ELECTRIC BED

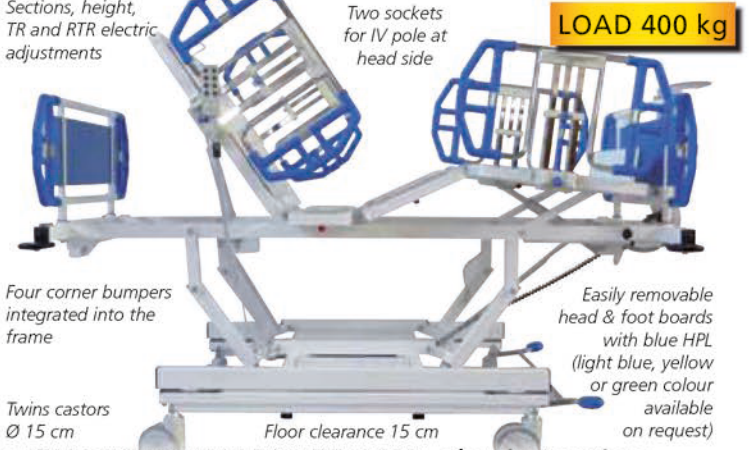

Sections, height, TR and RTR electric adjustments

Two sockets for IV pole at head side

LOAD 400 kg

Four corner bumpers integrated into the frame

Twins castors Ø 15 cm

Floor clearance 15 cm

Easily removable head & foot boards with blue HPL (light blue, yellow or green colour available on request)

• **27636 EXTENDABLE BARIATRIC BED - electric, 4 sections**
 Four section electrically driven bed frame in durable steel construction with adjustable height and TR-RTR. Made in Italy.
 - Trendelenburg 18° and Reverse Trendelenburg 18°
 - mattress platform positioning: backrest 0°-52°, legrest 0°-24°
 - manual handset with locking key+supervisor to adjust sections
 - electric CPR function
 - armchair position with excellent comfort
 - carer controlled lock out function for all controls
 - battery backup
 - central braking system with a three position pedal on foot side for greater control: steering / swivelling / braking
 - 3X standard twin castors Ø 15 cm and 1 antistatic and steering twin castor
 - 4 multi position and removable siderails, colour co-ordinated to bed frame

• **27638 LIFTING POLE with integrated IV hooks**

• **27639 RETRACTABLE BLANKET TRAY**

• **27640 IV POLE**

• **44810 FLAME RETARDANT BARIATRIC MATTRESS - 4 pieces with waterproof transpirant cover.** Load 300 kg. Density 40 kg/m². Size 90x200x18 cm (2 sides 15x200x18, 1 foot 15x120x18)



| TECHNICAL SPECIFICATIONS | |
|--------------------------------|---|
| Bed upper frame dimensions: | - fully retracted - 226x105 cm (bumpers included) - fully extended - 242x135 cm (siderails included) |
| Mattress platform adjustments: | - fully retracted - 200x90 cm - intermediate position - 200x105 cm - fully extended - 200x120 cm - foot extension - from 200 to 220 cm |
| Lowest-Highest position: | 41-81 cm |
| Bed weight: | 175 kg |
| Electrical shock protection: | Class 1 |
| Load capacity: | 400 kg |
| Liquid ingress protection: | IP 66 |



MECHANICAL AND SEMI AUTOMATIC OPERATING TABLES

90% RADIOTRANSIRENCY ON TOP

100% STAINLESS STEEL

COMPLETE MOVEMENTS

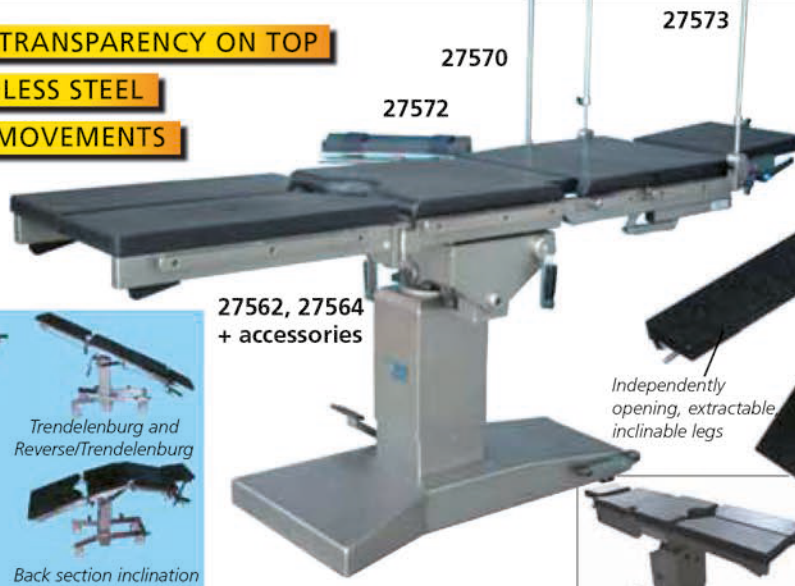
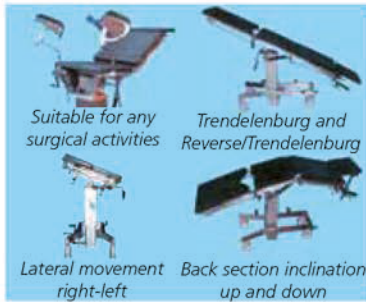

27562, 27564 + accessories



Independently opening, extractable inclinable legs

Several adjustment, up and down for all sections

STAINLESS STEEL, RADIOSURGICAL OPERATING TABLES

Designed to satisfy surgical functionality, practicality, quickness and easy maintenance. They allow, with proper accessories, to satisfy every basic surgical activity

- Table top

Divided in 5 sections (head, back, pelvis, 2 independent leg sections) with stainless steel structure and plexiglass to allow x-ray permeability and easy cleaning.

Table top is pre-arranged for the insertion of x-rays holders all over its length. Accessories holder (25x10 mm) in stainless steel, covers table top length on both sides.

- Telescopic column

Square and of limited size, covered by anodized aluminium (27560) or stainless steel (27562/4/5/6)), it allows up and down movement (approx. 70-100 cm) by a foot pedal placed at the base through a closed oleodynamic circuit with oil-tight pump avoiding any oil leakage (27560/2/4) or by remote control (27565/6).

- Mattresses

They cover all the table top length, made in a long lasting material, sterilizable in autoclave, x-ray translucent and elastic. They are independently removable.

- Base

For Solaris, it is moveable by four large antistatic castors, 2 directional and 2 pivoting with brake. For Gima and Gima TR

(mechanical and semi-automatic) base is completely made of stainless steel to ensure perfect stability. It is provided with a locking system to the floor through a foot bar. Transport is allowed by 3 antistatic wheels, one pivoting and 2 directional.

- Movements

For Solaris: Trendelenburg and Reverse/Trendelenburg with lateral tilt right-left 20° by crank. For Gima and Gima TR same table movements as above, work through a mechanical system moved by two cranks, positioned at the side, easily retractable, for semiautomatic by remote control.

- Longitudinal translation

Both Gima TR models offer manual longitudinal translation of table top of about 300 mm to allow total elimination of column encumbrance for 100% transparency of top.

- Full range of accessories. All tables come with mattress included, semiautomatic also includes control (with 1 m cable) batteries and crank for emergency of engine.

All operating tables are made in Italy.



| code | OPERATING TABLES |
|---|--|
| 27560 | Solaris operating table - mechanical |
| 27562 | Gima operating table - mechanical |
| 27564 | Gima TR operating table with longitudinal translation of table top - 100% radiotransparency |
| 27565 | Gima operating table - semiautomatic - need 27559 |
| 27566 | Gima TR operating table - semiautomatic with longitudinal translation of table top - 100% radiotransparency - need 27559 |
| ACCESSORIES FOR ALL OPERATING TABLES - 100% stainless steel | |
| 27568 | Wristlet with clamp - couple |
| 27569 | Rectangular s/s gynaecological basin - 200x320x150 mm |
| 27570 | Two-hook adjustable IV stand (needs clamp 27571) |
| 27571 | Clamp for IV stand |
| 27572 | Arm holder adjustable 90-180° with cushion and clamp |
| 27573 | Drape support with adjustable height with 2 clamps 27576 |
| 27576 | Clamp for drape support - spare |
| 27574 | Leg holder with radio transparent valve and cushion - couple (needs 2 clamps 27575) |
| 27575 | Clamp for leg holder |
| ACCESSORIES FOR SEMIAUTOMATIC TABLES (27565-6) | |
| 27558 | Infrared control |
| 27559 | Battery charger |

| | TECHNICAL SPECIFICATIONS | | |
|----------------------------|---|-------------|-------------|
| | 27560 | 27562-27564 | 27565-27566 |
| Table top size | 200x48 cm | 200x48 cm | 200x48 cm |
| Height | 70-100 cm | 75-105 cm | 75-105 cm |
| Lifting system | Mechanical | Mechanical | Electric |
| - Trendelenburg | 30° | 35° | 35° |
| - Reverse Trendelenburg | 30° | 25° | 25° |
| - Lateral tilt right-left | 20° | 25° | 25° |
| Table top composition | extractable and inclinable (+25° -90°) | | |
| - Head section | by gas spring | | |
| - Back section inclination | -40° +80° | -20° +80° | -20° +80° |
| - Pelvis section size | by gas spring size 48x51 cm | | |
| - Leg section | mechanical size 48x49 cm | | |
| | divided in two independent sections with following manual movements | | |
| | • opening right/left of 0°/90° | | |
| | • inclination +30° -90° | | |
| | • both parts are easily independently extractable | | |
| Table weight: | 90 kg | 160 kg | 160 kg |
| Operating table capacity: | 200 kg | 250 kg | 250 kg |
| Made in Italy | | | |

ISO SERVICE TROLLEYS - MADE IN ITALY



Size:
65x47xh 100 cm
Weight: 12.5 kg

27935

Pivoting castors
Ø 100 mm
(2 with brake)

• **27935 ISO SERVICE TROLLEY - empty**
Service trolley for "ISO" trays or baskets (not included) made in epoxy powder painted steel. Supplied with 5 height adjustable + 1x27924 runners for 3x27938 ISO trays/baskets.



Both side basket pulling out with stopper to avoid accidental fall.



Size:
59x99.3xh 88 cm

Adaptable to any model of ISO 600x400 baskets and trays thanks to the special rail sides, which allow an easy sliding and pull out.

27934

4 wheels Ø 125 mm
(3 with brake)

• **27934 AURION MINI 600 - ISO trolley - empty**
Basic body made in Baydur Polyurethane - Bayer AG: it can be washed and disinfected. It does not react with diluted acids, alkali and solvents. Self-extinguishing according to class UL V0 - Latex Free. For safety, handles are moulded into the body on both sides, trolley top has a 4-sided moulded containing rim to avoid any spilling/falling of materials. No sharp edges. All around bumper. Lightweight and easy to move.

Lockable with double key



27936

Equipped with key lock and doors kit made in transparent polycarbonate.

Side plastic runners for "ISO" trays or baskets

(baskets and trays not included)

• **27936 ISO TRANSPORT TROLLEY - empty**
Transport trolley for ISO trays and baskets (not included). Made in stainless steel AISI 304 sheet, scotch brite finishing. Anti-dust gasket. Internal side with plastic runners for ISO trays or baskets. Supplied with handle for transport.

Handle for transport

27936

(baskets and trays not included)

27936

27936

27936

27936

27936

27936

27936

27936

27936

27936

27936

27936

27936

27936

27936

27936

27936

27936

27936

27936

27936

27936

27936

27936

27936

27936

27936

27936

27936

27936

27936

27936

27936

27936

27936

27936

27936

27936

27936

27936

27936

27936

27936

27936

27936

27936



Antistatic castors
Ø 125 mm (2 with brake)

27996

27995

| ISO MODULAR TRAYS | | GREY ABS | |
|-------------------|-------|-------------|--|
| Closed | Open | SIZE mm | |
| 27924 | - | 600x400x50 | |
| 27925 | 27938 | 600x400x100 | |
| 27928 | 27939 | 600x400x200 | |
| TRANSPARENT PC | | SIZE mm | |
| Closed | Open | SIZE mm | |
| 27957 | - | 600x400x50 | |
| 27958 | 27965 | 600x400x100 | |
| - | 27966 | 600x400x200 | |

Intelligent solutions for storing all kind of drugs, bandages, accessories and small components in a space saving and clear manner.

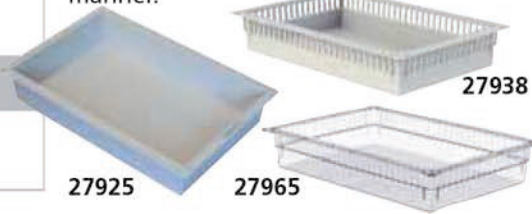

27925

27965

27938

| DIVIDERS | |
|----------|----------------|
| code | SIZE mm |
| 27994 | 400x50 mm |
| 27995 | 600x50 mm |
| 27996 | 400x100 mm |
| 27997 | 600x100 mm |
| 27998 | 400x200 mm |
| 27999 | 600x200 mm |
| 28001 | Drawer stopper |

INOX WORKING TABLE



27909

• **27909 INOX WORKING TABLE**
Working table, equipped with two drawers (47x30x12 cm) each side, to work on both sides. Stainless steel AISI 304 frame, structure made of square tubular, table top and lower shelf made of smooth stainless steel. Mounted on 4 castors Ø 100 mm, two with brakes. Weight 50 kg. Size 120x70xh 95 cm. Max load (x shelf): 40 kg. Delivered in kit form 122x35x72 cm. Made in Italy.

OPERATING THEATRE INSTRUMENT TABLES

Shelf size: 120x65 cm



Safety protection
on 3 sides

27913

• **27913 INSTRUMENT TABLE 2 SHELVES**
Operating room instruments table made of stainless steel AISI 304 scotch brite finish. 125 mm Ø revolving castors (2 with brake). Weight: 28 kg. Load for shelf: 40 kg. Size: 120x65xh 95 cm. Delivered in kit form (123x13x68 cm). Made in Italy.

Stainless steel adjustable
105-136 cm upper part
with 4 instrument hooks.



27914

• **27914 INSTRUMENT TABLE 1 SHELF**
Operating room instruments table made of stainless steel AISI 304, scotch brite finish. 125 mm Ø revolving castors (2 with brake). Weight: 21 kg. Load: 40 kg. Size: 120x65xh 95 cm. Delivered in kit form (123x13x68 cm). Made in Italy.

OPERATING ROOM INOX CABINETS

PAINTED STEEL CAB



27917

• **27917 INOX CABINET**
 Made of AISI 304 stainless steel.
 Two lockable doors (10/10 thickness),
 4 adjustable shelves (8/10 stainless),
 4 adjustable feet, with stainless steel
 cover. Size: 100x48xh 190 cm.
 Weight: 130 kg.
 Made in Italy.



27918

• **27918 GLASS-INOX CABINET**
 Made of AISI 304 stainless steel with
 two lockable doors in tempered glass
 5 mm thick, 4 shelves in tempered glass
 6 mm thick and 4 adjustable feet.
 Size: 100x48xh 190 cm. Weight: 105 kg.
 Made in Italy.



27916

• **27916 PAINTED STEEL CABINET**
 Epossidic powder painted
 steel cabinet with 4 adjustable
 shelves, lockable doors,
 4 adjustable feet.
 Size: 100x50xh 200 cm.
 Made in Italy.

SHELVING SYSTEM

INSTRUMENT TROLLEY

ANAESTHETIC TROLLEY



27908

• **27908 SHELVING SYSTEM**
 Shelving system, made of AISI 304
 stainless steel, scotch brite finish.
 With 5 stainless steel reinforced shelves
 at fixed position.
 Possibility to fix
 together several
 shelving systems.
 Size: 100x50xh 200 cm
 Load x shelf: 25 kg
 Weight: 30kg
 Made in Italy.



27442

• **27442 INSTRUMENT TROLLEY**
 Made of satined welded AISI 304
 stainless steel. With 4 sliding drawers
 (internal, 49x33xh 18 cm)
 Top drawer lockable, upper shelf with
 safety edges to carry instruments.
 4 revolving castors Ø 80 mm
 Size: 60x40xh 110 cm
 Weight: 37 kg
 Made in Italy.



27437

• **27437 ANAESTHETICS TROLLEY**
 Made of satined AISI 304 stainless steel,
 with 6 drawers (internal 26x37xh 7 cm),
 a lockable vertical compartment and an
 open space.
 Top with 3.5 cm upstand.
 4 revolving castors Ø 80 mm
 Size: 60x40xh 110 cm
 Weight: 39 kg
 Made in Italy.

STAINLESS STEEL, INSTRUMENT AND DRESSING TROLLEYS



27430

- **27430 INOX TROLLEY**
AISI 304 Stainless steel trolley with plastic drawer internally divided in 4 sectors. 2 shelves with upstands (3,5 cm) on four sides. Revolving rubber castors Ø 80 mm (two with brake).
Size: 70x50xh 82 cm.
Max load (x shelf): 25 kg.
Delivered in kit form.
Made in Italy.



27433

- **27433 MEDICAZIONE TROLLEY - small**
Size: 60x40xh 81 cm - weight 8 kg
 - **27434 MEDICAZIONE TROLLEY - medium**
Size: 70x50xh 82 cm - weight 9 kg
 - **27435 MEDICAZIONE TROLLEY - large**
Size: 90x60xh 85 cm - weight 15 kg
- AISI 304 stainless steel trolleys, with push handle, 2 shelves with upstands (3,5 cm) on four sides, 4 revolving rubber castors Ø 60/80/90 mm. Max load (x shelf): 25 kg.

*Delivered in kit form.
Made in Italy.*



27431

- **27431 TER TROLLEY**
AISI 304 Stainless steel trolley, with push handle.
3 shelves with upstands (3,5 cm) on four sides, 4 revolving rubber castors Ø 80 mm.
Size: 70x50xh 82 cm - weight 13 kg
Max load (x shelf): 25 kg
Delivered in kit form.
Made in Italy.



27436

- **27436 DRESSING TROLLEY**
Dressing trolley made of AISI 304 stainless steel with 2 shelves (70x50 cm), 1 drawer (40x50xh 15 cm), basin holder and basin. 4 revolving castors Ø 100 mm.
Size: 70x50xh 85 cm - weight: 18 kg.
Max load (x shelf): 25 kg.
Delivered in kit form. Made in Italy.



45800

- **45800 MEDICAZIONE PLUS TROLLEY**
With removable trays
Stainless steel frame mounted on castors Ø 80 mm.
Size: 61x43xh 78 cm. Weight: 10 kg.
Maximum load (x shelf): 10 kg.
Delivered in kit form.
Made in Italy.



45805

- **45805 TER PLUS TROLLEY**
With removable trays
Stainless steel frame, mounted on castors Ø 80 mm.
Size: 49x30xh 78 cm. Weight: 9 kg.
Maximum load (x shelf): 10 kg.
Delivered in kit form.
Made in Italy.

LANCART: STAINLESS STEEL TROLLEY TO BUILD UP

- **45810 LANCART TROLLEY - small**
Size: 60x40xh 80 cm
 - **45811 LANCART TROLLEY - medium**
Size: 70x50xh 80 cm
- Stainless steel trolley mounted on castors Ø 80 mm. Maximum trolley load: 60 kg.
Delivered in kit form. Made in Italy.
You can add following accessories:
- **45815 SET OF SIDERAILS (for 1 shelf)** for 45810
 - **45816 SET OF SIDERAILS (for 1 shelf)** for 45811
 - **45817 BOTTLE RACK**
 - **45818 WASTE BIN**



45810

Size:
60x40xh 80 cm



Set of siderails

BUILD UP YOUR TROLLEY

Waste bin

45810
+ 2 x 45815
+ 45817
+ 45818

Bottle rack



ANODIZED ALLOY OR ALUMINIUM TROLLEYS

REX TROLLEY



27429

- **27429 GIMA 2 TROLLEY**
- small: 60x40xh 77 cm - weight 11 kg
- **27425 GIMA 2 TROLLEY**
- medium 70x50xh 78 cm - weight 14 kg
Practical trolleys with aluminium body and handles. With 2 white bilaminated shelves 18 mm thick, black PVC bordered, with guard-rail. Two large lateral handles facilitate transport or lift up of the trolley. 4 revolving nylon castors Ø 80 mm. Max load (x shelf): 40 kg.
- **27426 GIMA 3 TROLLEY**
- medium 70x50xh 78 - weight 15 kg.
Same as GIMA2, but without guard rail. Delivered in kit form. Made in Italy.



27461

- TOP QUALITY**
- **27460 DELUXE TROLLEY**
 - **27461 DELUXE TROLLEY with drawer 62x42 cm**
Size: 65x45xh 80 cm
Top quality trolleys made of lightweight anodized special alloy, with detachable stainless steel shelves.
4 revolving rubber castors Ø 80 mm.
Max load (x shelf): 15 kg.
Delivered in kit form.
Made in Italy.



27439

- **27439 REX TROLLEY**
Complete stainless steel dressing trolley. Supplied with 3 shelves, waste bin, drawer, support for bottles, guard rails on the two bottom shelves, 4 wheels, Ø 100 mm (2 with brakes).
Size: 79x50xh 120 cm (handle included).
Delivered in kit form (75x52x112 mm).
Drawer 64x43xh 9.5 cm.
Made in Italy.

BOWL STANDS

- **27456 SINGLE BOWL STAND**
- **27457 DOUBLE BOWL STAND**
Chrome plated steel stand with stainless steel base and 5 plastic wheels, one with brake. Adjustable height from 60 to 95 cm
Stainless steel bowl Ø 32 cm, 4 l capacity included.
Available with one or two bowls. **Delivered in kit form.**
- **27459 S/S BOWL Ø 32 cm - spare**

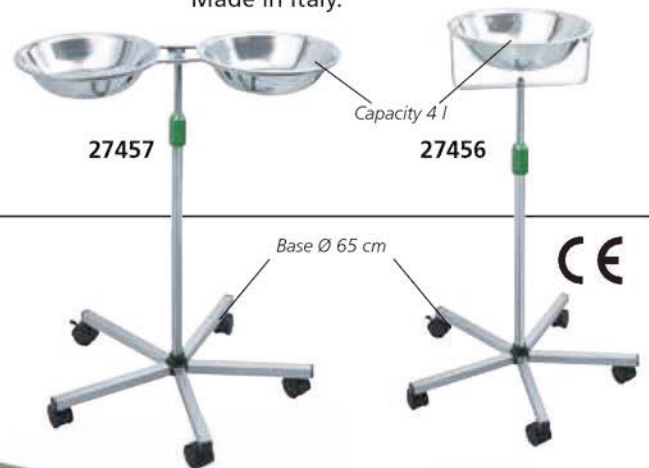

27457

Capacity 4 l

27456

Base Ø 65 cm



MAYO TABLES



27453



27455

27454



Tray internal size:
70x45xh 1.7 cm

45832

Height adjustable
90-115 cm

45830

- **27453 MAYO TABLE - 5 spokes**
S/s tray, 5 spokes with castors, Ø 50 mm and adjustable height.
Delivered in kit form. Made in Italy.

- **27454 MAYO TABLE - s/s base**
- **27455 MAYO TABLE - s/s base and pump**
With removable s/s tray, s/s AISI 304 base with 4 castors (50 mm) and adjustable height. **Delivered in kit form.** Made in Italy.

- **45830 MAYO TABLE - U-SHAPE**
- **45832 MAYO TABLE - 5 SPOKES**
Stainless steel base with castors Ø 50 mm: 5 spokes (45832) or U-shape (45830).
Stainless steel frame and removable tray. Adjustable height.
Delivered in kit form.
Made in Italy.

TECHNICAL SPECIFICATIONS

| | 27453 | 27454 | 27455 | 45830-45832 |
|--------------------|-----------|-----------|----------------|----------------|
| S/S tray size: | 68x46 cm | 68x46 cm | 70x45xh 1.8 cm | 70x45xh 1.7 cm |
| Adjustable height: | 70-110 cm | 70-110 cm | 85-120 cm | 90-115 cm |
| Weight: | 8 kg | 12 kg | 19 kg | 10 kg |
| Load: | 20 kg | 20 kg | 25 kg | 10 kg |

BAG HOLDER TROLLEYS



45905+45910



45906+45910

- 45905 BAG HOLDER TROLLEY - 2 bags
 - 45906 BAG HOLDER TROLLEY - 3 bags
- Bag holder trolleys with pedal operated opening. Rigid, sturdy, self-supporting ABS plastic base with edges. The bag holding ring (35x25.5 cm) is made of glass reinforced nylon with a rubber gasket to hold the bag in place. Two vertical tubes made of AISI 304 stainless steel are



45905+27462+27466+45910

welded to the base and carry the bag holding ring. Non marking grey rubber swivelling wheels Ø 80 mm (two with pedal operated brake). Made in Italy.

- 45910 PUSH HANDLE
 - 27466 WRAPPING BAG - yellow strip
 - 27462 WRAPPING BAG - blue strip
 - 45908 WRAPPING BAG - green strip
- White synthetic bag with strip, washable up to 200 times. Size 57xh 103 cm. Made in Italy.

SHUT BAG HOLDER



45900

- 45900 SHUT BAG HOLDER - 70 l
- Trolley suitable for carrying one 70 l bag (not included). Stainless steel AISI 304 structure. Equipped with swivelling castors with brake and bumpers. For use with standard 70 l plastic bag. Can use also wrapping bag (27462, 27466, 45908) Made in Italy.

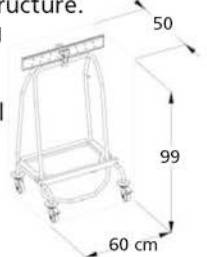

LAUNDRY TROLLEYS



Wrapping bag not included
27465 + 27462

- 27464 LAUNDRY TROLLEY - painted steel
 - 27465 LAUNDRY TROLLEY - stainless steel
- These trolleys allow to collect dirty laundry while distributing clean linen at the patient bedside. Stainless steel or painted steel frame. Equipped with 4 Ø 125 mm castors (2 with brake) and 4 rubber bumpers at corners. Size: 135x65xh 102 cm. Made in Italy.
- 27463 SIDE PANEL - painted steel
 - 27466 WRAPPING BAG - yellow strip
 - 27462 WRAPPING BAG - blue strip
- washable up to 200 times, 57xh 103 cm



27464+27462

27465+27462+27463



45915

- 45915 LAUNDRY TROLLEY - laminated
- Closed trolley with doors, 3 shelves plus top and 2 bag holders. Laminated particle board body and stainless steel AISI 304 structure. Equipped with swivelling castors, 2 with brake and bumpers. Size: 110x66x132 cm. Made in Italy.
- 27462 WRAPPING BAG - blue strip
 - 27466 WRAPPING BAG - yellow strip
- White washable laundry synthetic bag with yellow or blue strip. Size: 57xh 103 cm. Made in Italy.



SOILED LINEN



27467

- 27467 SOILED LINEN TROLLEY
 - 27468 DOUBLE SOILED LINEN TROLLEY
- Chrome plated frame with 3 or 4 castors Ø 80 mm. Removable bag. Size: Ø 46xh 90 cm. Delivered in kit form.



27468

Size: 92x90 cm

MULTIFUNCTIONAL CARTS - MADE IN ITALY

SMART CARTS

BUILD UP YOUR FAVOURITE CART



Compatible with 4 hook metal support 27846

27870



27870 + 27872

27870 + 27888

27870 + 27873 + 27874



With VESA 75/100 connection for monitor

27869 + 27873



Aluminium structure

Shelves made with coat of paint sheets

27896 + 27874

Wheel load: dynamic charge: 70 kg static: 140 kg

SUPER EASY CART: A new stylish and quality cart you can build according to your needs

TECHNICAL SPECIFICATIONS

Dimensions: 47x42x79 cm
Shelf: 32x26 cm or 40x36 cm
Load capacity: total load 120 kg shelf 10 kg
4 castors Ø 80 mm (2 with brake)
Material: - extrusions in aluminium
- plastic parts in ABS
Shelf: steel sheet epoxy powder coated

| code | SUPER EASY CARTS - WITH HANDLE |
|--------------------------------------|---|
| 27870 | Cart with 1 shelf (32x26 cm) |
| 27869 | Cart with shelf (40x36 cm), monitor support |
| 27871 | Cart with large shelf (40x36 cm) |
| ACCESSORIES for all SUPER EASY CARTS | |
| 27872 | Extra shelf 32x26 cm |
| 27873 | Basket |
| 27874 | Infusion stand |
| 27875 | Extra shelf 40x36 cm |
| 27888 | Cardio arm for ECG |

SMART CART - grey/white RAL 7035
Carts with 3, 4 or 5 wide, sturdy shelves 4 castors Ø 80 mm (2 with brake).

| code | SMART CARTS |
|-------|---------------------------------|
| 27895 | Cart h80 cm 3 shelves 40x36 cm |
| 27896 | Cart h90 cm 4 shelves 40x36 cm |
| 27897 | Cart h115 cm 5 shelves 40x36 cm |
| 27873 | Basket |
| 27874 | Infusion stand |
| 27888 | Cardio arm for ECG |

TRIS TROLLEY



27438

• **27438 TRIS TROLLEY**
A practical trolley for ECG, Electrosurgical unit or any other device, with 4 nylon castors and 2 lateral handles for easy moving. Revolving castors Ø 50 mm. Size: 49x37xh 77 cm. Shelf size: 40x30 cm. Colour: RAL 9002
Delivered in kit form.
Made in Italy.

EASY CARTS - MADE IN ITALY

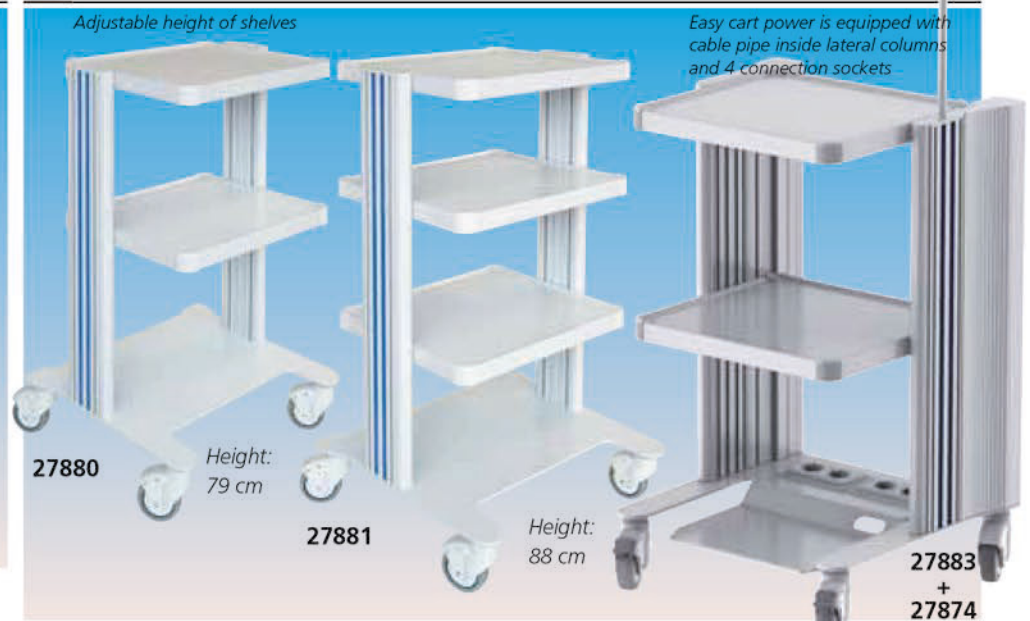

Adjustable height of shelves

Easy cart power is equipped with cable pipe inside lateral columns and 4 connection sockets

27880

Height: 79 cm

27881

Height: 88 cm

27883 + 27874

EASY CART
A complete line of stylish and sturdy carts with 3, 4 or 5 shelves and with power.

TECHNICAL SPECIFICATIONS

Dimensions (WxDxH): 50x45x79/88/112 cm
Load capacity: total load 140 kg shelf 25 kg
Shelves: 40x36 cm
4 castors Ø 80 mm (2 with brake)
Material: - vertical aluminium extrusions
- plastic parts in ABS
Shelf: steel sheet epoxy powder coated

| code | EASY CARTS |
|------------------------|--------------------------------------|
| 27880 | Cart h79 cm 3 shelves 40x36 cm |
| 27881 | Cart h88 cm 4 shelves 40x36 cm |
| 27882 | Cart h112 cm 5 shelves 40x36 cm |
| 27883 | Cart power h79 cm 3 shelves 40x36 cm |
| ACCESSORIES EASY CARTS | |
| 27873 | Basket 30x16xh 14.5 cm |
| 27874 | Infusion stand |
| 27884 | Extra shelf 40x36 cm |
| 27888 | Cardio arm for ECG |

DOUBLE FACE PHARMACY TROLLEY - MADE IN ITALY



• **27499 DOUBLE FACE PHARMACY TROLLEY** - 3 large, 30 small drawers
Two trolleys in one: 3 large drawers on one side, 30 (6+9+15) monodose cassettes on other side; with locking system.

Size of cassettes:
- 6 cassettes 115x290xh 75 mm
- 9 cassettes 115x290xh 45 mm
- 15 cassettes 70x290xh 45 mm
Size of trolley:
920x590xh 810 mm
Provided with 4 revolving castors Ø 125 mm (3 with brake, 1 of trolley, antistatic).



• **45730 DOUBLE FACE PHARMACY TROLLEY** - 3 large, 22 small drawers
Two trolleys in one: 3 large drawers on one side, 22 (6+6+10) monodose cassettes on other side; with locking system.

Size of cassettes:
- 6 cassettes 115x290xh 75 mm
- 10 cassettes 115x290xh 45 mm
Size of trolley:
920x590xh 810 mm
Provided with 4 revolving castors Ø 125 mm (3 with brake, 1 of trolley, antistatic).



• **45731 DOUBLE FACE PHARMACY TROLLEY** - 62 small drawers
Two trolleys in one: 31 (6+10+15) monodose cassettes on both sides; with locking system.

Size of cassettes:
- 6 cassettes 115x290xh 75 mm
- 10 cassettes 115x290xh 45 mm
- 15 cassettes 70x290xh 45 mm
Size of trolley:
920x590xh 810 mm
Provided with 4 revolving castors Ø 125 mm (3 with brake, 1 of trolley, antistatic).



DOCTOR TROLLEY



• **27446 DOCTOR TROLLEY**
Useful trolley made of plastic material (ABS) provided with 9 drawers of different sizes.
Height of drawers: two 8.5, five 5.5, two 2.7 cm. Size: 38x30xh 72 cm.
Made in Europe.

EXCEL TROLLEY



Castors Ø 100 mm (2 with brake).
Excel Trolleys are produced without upstands at four sides for an easier cleaning.
• **27440 EXCEL TROLLEY** - 3 shelves (60x45cm) Size: 67x69xh 80 cm.
• **27441 EXCEL TROLLEY** - 4 shelves (60x45cm) Size: 67x69xh 110 cm.
Maximum load: 80kg
Delivered in kit form. Made in Italy.

PROFESSIONAL KARTS

Made in Italy

All professional carts are supplied with cable pipe inside lateral columns.



• **27885 PRO CART** 2 shelves - h 80 cm
• **27887 PRO CART** 2 + keyboard, monitor support
• **27883 BASKET**
• **27884 INFUSION STAND**

TECHNICAL SPECIFICATIONS

Load capacity: - total load 240kg - shelf 35kg
Base: 60.8x50 cm
Shelves: 2 shelves 50x50 cm + base
Material: - vertical extrusions in aluminium
- plastic parts in ABS
Made in Italy

DRUGS & MEDICINE TROLLEYS - MADE IN ITALY



27495



27497



27494

- 27494 PHARMACY TROLLEY - small with 15 3-compartment partition
- 27495 PHARMACY-TROLLEY - standard with 20 3-compartment partition
- 27497 PHARMACY TROLLEY - large with 30 3-compartment partition

A portable pharmacy, allowing to manage daily or weekly treatment of patients, with 15/20/30 3 compartments small drawers for easy drug storage (45-60-90 spaces). Painted steel frame, technopolimer surface and panels. Can be completely closed by safety key lock. Provided with 4 revolving castors Ø 125 (2 with brake); Size 820/1150x640xh 1,000 mm.

- 27498 PARTITION - 3 compartments - spare



4 x 27498

27498

DRUGS & MEDICINE CABINETS - MADE IN ITALY



27942, 27944



27941



MEDICINE CABINETS 100x60xh 195 cm
 With drugs compartment, 48 medicine compartments and 5 adjustable shelves
 - made in bilaminated board (27944/5) or melamine board (27942) 20 mm thick
 - epoxy powder painted steel base frame with 4 adjustable feet Ø 50 mm
 - 2 external lockable doors turning through 180° with 8 medicine compartments each (extendable to 10 compartments)
 - perimetrical anti-dust gaskets
 - inside 2 containers with 8 medicine compartments each side (extendable to 10 compartments) turning through 90°
 - dangerous drugs compartment provided with lock



- 27941 COMBO MEDICINE CABINETS
 With 24 medicine compartments one side and 6 ISO tray 1 shelf and 3 drawers other side
 - made in bilaminated board 20 mm thick
 - epoxy powder painted steel base frame with 4 adjustable feet Ø 50 mm
Right side
 - 1 external lockable door turning through 180° with 8 medicine compartments each (extendable to 10 compartments)
 - perimetrical anti-dust gaskets
 - inside 1 container with 8 medicine compartments each side (extendable to 10 compartments) turning through 90° provided with lock
Left side
 - glass door, internal side with runners for ISO trays
 - 3 drawers on the bottom
 Supplied with 6 ISO trays different heights (2xh 5 cm, 3xh 10 cm and 1xh 20 cm) and 1 shelf.
- 27946 COMPARTMENT FOR MEDICINE - spare

| code | MEDICINE CABINET | Material | Colour | | | | | | | |
|----------|--------------------------|-------------------------|-------------|-----|-----|-----|-----|-----|-----|------|
| 27942 | Medicine cabinet | melamine particle board | white | | | | | | | |
| 27944 | Medicine cabinet | bi-laminated board | white | | | | | | | |
| 27945 | Medicine cabinet | bi-laminated board | any colour* | | | | | | | |
| 27946 | Compartment for medicine | | | | | | | | | |
| Colours: | 412 | 431 | 441 | 452 | 482 | 484 | 499 | 854 | 861 | 1818 |

*You have to indicate requested colour with order. Available in 30 days

MULTI-FUNCTIONAL TROLLEYS: BASIC AND DRESSING

MULTIFUNCTIONAL TROLLEYS: BASIC - DRESSING

These multifunctional professional trolleys have painted steel structure and external plastic finishing. Basic and Dressing are available in 3 different sizes (small, standard, medium). Provided with 4, 8 or 9 drawers, one lateral basket and one extra lateral table. Four swivelling rubber castors Ø 125 mm (2 with brake). Made in Italy.

BASIC



45702 Standard

BASIC TROLLEY - 3 sizes
Standard version without accessories



27476 Standard



27477 Small

DRESSING



27481 Standard



45701 Small



27484 Medium

DRESSING TROLLEY - 3 sizes
Same as Basic, but equipped with instrument tray and upper dispenser (10 tilting bins).

- DIVIDER KIT** - size: 20/35/50x43xh 7 cm
- 27470 KIT for drawer 30 cm - 8 compartments
 - 27471 KIT for drawer 45 cm - 20 compartments
 - 27472 KIT for drawer 60 cm - 25 compartments



Partitions are removable

| BASIC | | DRESSING | | Size Type | Size of trolley (cm) (without accessories) | Number of drawers | Size of drawers cm | | | | | |
|--------|-------|----------|-------|-----------|--|-------------------|--------------------|-----------|-----------|-----------|-----------|-----------|
| Yellow | Blue | Yellow | Blue | | | | 45x48xh13 | 45x48xh27 | 60x48xh13 | 60x48xh27 | 30x48xh13 | 30x48xh27 |
| 27477 | 45700 | 27478 | 45701 | Small | 67x64xh 100 | 4 | 3 | 1 | - | - | - | - |
| 27480 | 45702 | 27481 | 45703 | Standard | 82x64xh 100 | 4 | - | - | 3 | 1 | - | - |
| 27476 | 45704 | - | - | Standard | 82x64xh 100 | 9 | - | - | - | - | 8 | 1 |
| 27483 | - | 27484 | - | Medium | 102x64xh 100 | 8 | 3 | 1 | - | - | 3 | 1 |
| 27486 | - | - | - | Large | 115x64xh 100 | 8 | - | - | 3 | 1 | 3 | 1 |

RECORD HOLDERS AND X-RAY FILM HOLDERS TROLLEYS



- 27490 RECORD HOLDERS TROLLEY - sliding top
 - 27491 RECORD HOLDERS TROLLEY
 - 27492 RECORD HOLDERS TROLLEY - 2 large drawers
- Record trolleys are designed to hold clinical reports in A3/A4 format or specific format. Frame in epoxy painted steel, working surface and panels in technopolimer plastic. Equipped with 4 Ø 125 mm swivelling rubber castors (2 with brake). Bumpers around the perimeter. Made in Italy.
Size: 820x640xh 1,000 mm (code 27491 and 27490)
820x640xh 1,150 mm (code 27492).
- 27493 FILE RACK A3 special

- 27488 X-RAY FILM HOLDER
- This trolley has 32 extractable compartments, a wide top surface, 4 side document holders, and a sliding out writing surface. Frame is in painted steel with sliding-in bilaminated doors with a 270° opening. Base and lateral cabinets are made in technopolimer material. Equipped with 4 Ø 125 mm swivelling rubber castors (2 with brake). Size 820x640xh 1, 200 mm. Made in Italy.
- 27489 COMBO FILES AND X-RAY FILM HOLDER
- Same as above, but with 15 X-ray compartments and drawer that holds up to 25 files (not included).



EMERGENCY TROLLEYS

EMERGENCY TROLLEYS - small and standard

Professional trolley with painted steel structure and external plastic finish equipped with 4 drawers, one lateral waste container, one extra lateral table, I.V. stand, defibrillator holder (plexiglass tray), oxygen holder up to 5 litres (back), 2 antistatic rubber castors.

- 27479 EMERGENCY TROLLEY - small 67x64xh 100 cm
- 27471 DIVIDER KIT for 27479 (drawer 45 cm)
- 27482 EMERGENCY TROLLEY - standard 82x64xh 100 cm
- 27472 DIVIDER KIT for 27482 (drawer 60 cm)

DISPOSABLE SEALS

- 27473 DISPOSABLE SEALS - box of 100
- 27474 DISPOSABLE NUMBERED SEALS - box of 100



EMERGENCY STANDARD

Transparent cardiac board

3 drawers
60x48x13 cm

1 drawer
60x48x26 cm

Built in perimetral protection



KS MULTIFUNCTIONAL TROLLEYS

MULTIFUNCTIONAL TROLLEYS: BASIC, DRESSING, EMERGENCY

Professional trolleys in 2 sizes (small and standard) and 3 models (Basic, Dressing and Emergency).

- antimicrobial epoxy painted body with seal lock (Emergency) or key lock (Basic and Dressing)
- top surface with 4-sided rim
- top surface with built-in compartment
- ball-bearing full-extension sliding drawer with self-closing system

- built-in handle
- 4 swivelling castors Ø 125 mm - 2 antistatic (only 45688/9) and with brake
- lateral waste container 15 l with lid and catheter holder (Dressing and Basic only)
- size: small 760x714xh 1,022 mm
standard 911x704xh 1,075 mm

Lateral side with waste container 15 l with lid and catheter holder



Dispenser with pole including 10 tilting bins



Back with large oxygen tank compartment and stainless steel holding rail with hooks

Lateral side with waste containers 15 l with lid



Writing surface

Lateral container unit with 4 supply trays



Writing surface

Lateral container unit with 4 supply trays



- 45680 BASIC TROLLEY - small
- 45681 BASIC TROLLEY - standard

- 45684 DRESSING TROLLEY - small
 - 45685 DRESSING TROLLEY - standard
- Dressing trolley is supplied with upper dispenser (10 tilting bins).

- 45688 EMERGENCY TROLLEY - small
 - 45689 EMERGENCY TROLLEY - standard
- Emergency trolley is supplied with rotating defibrillator/monitor tray, height adjustable I.V. pole with 2 hooks.

AURION MULTIFUNCTIONAL TROLLEYS - TOP QUALITY

AURION TROLLEYS

A multifunctional and revolutionary line of carts with innovative design, superior quality and complete accessories.

Made in Baydur® polyurethane

Baydur® Polyurethane is a high performance material that combines the best characteristics of plastics and metals. Light, sturdy, high resistance to scratching and impact. Resistant to UV rays. Chemical inert, doesn't react to acids, organic and inorganic, alkali and solvents (DIN 68861/1).

Fire resistant, self-extinguishing (Class I, UL94 V-O). Non-toxic, in case of combustion it doesn't produce dioxin.

Well-designed

The Aurion trolleys are ergonomic, modular, highly customizable and upgradable over the years. The handles are moulded and integrated into the body as well as the worktop that has large surface and perimetrical anti-drip containing rim. Every drawer is equipped with a label holder.

Easy to move

Lightweight structure combined with the high quality non-marking and anti corrosion castors. Every wheel is mounted on ball bearings with sealed lubrication (2 per wheel), 3 with brake, 1 antistatic.

Hygienic and safe

The smoothly shaped design, without edges, guarantees safety to the user and avoids dirty and bacterial accumulation points. Easy to clean and disinfect also with aggressive detergents.

Safe and secure

All-around soft rubber bumper help to avoid damages to hospital staff, patients, objects or to the trolley itself.

Central locking device with key (45740-45746) or with seal (45750-45751).

Size 775x710xh 920 mm

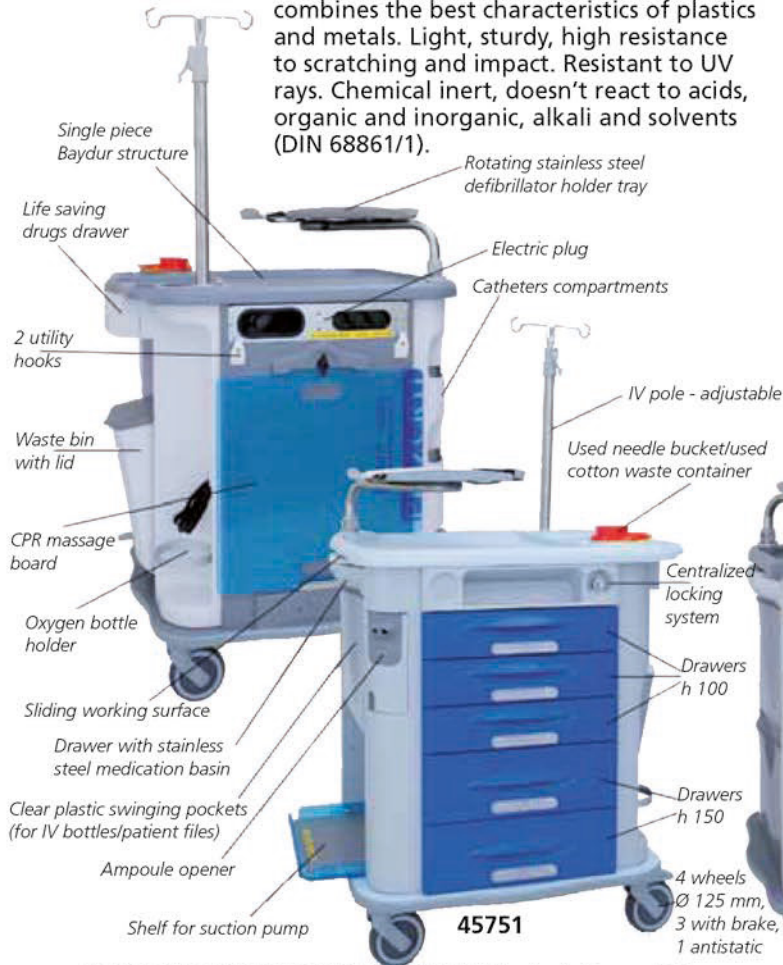

- 45751 AURION EMERGENCY TROLLEY - dark blue - 5 drawers
- 45750 AURION EMERGENCY TROLLEY - red - 4 drawers with IV stand, defibrillator tray, suction unit shelf (45751 only), CPR massage board, electric plug (45751 only).



- 45755 AURION AMAGNETIC TROLLEY - yellow - 5 drawers with amagnetic wheels, without locking system



- 45740 AURION THERAPY TROLLEY - green - 4 drawers
- 45741 AURION THERAPY TROLLEY - light blue - 5 drawers with IV stand (45751 only), upper drawers, bin (45741 only)
- 45744 AURION DRESSING TROLLEY - blue - 5 drawers
- 45746 AURION MONODOSE TROLLEY - brown - 2 drawers + 2 monodose cassettes (10 small drawers each)



MULTIFUNCTIONAL AND EMERGENCY KARTS

MULTIFUNCTIONAL KARTS

High quality aluminium multifunctional and emergency carts with superior features.

- work-top in high performance copolymer, with perimetric edge for liquid containment
- extruded aluminium frame, with superficial silver antioxidant treatment offering more lightness, resistance and reliability
- ergonomic stainless steel handles, fitted on both sides for easy handling
- drawer structure built in steel sheets, epoxy powder coated
- full pull-out sliding drawers

- interchangeable drawer position
- aluminium drawer handle with "hook/unhook" system to prevent accidental opening of drawers



Centralized locking system with key



Small drawer
Medium drawer
Large drawer

- 45660 COMPACT KART - 5 drawers - blue
- 45661 UPPER DRAWERS (9+5) - blue for 45660
- 45662 MEDIUM KART - 5 drawers - blue
- 45663 UPPER DRAWERS' (9+5) - blue for 45662
- *Included support for glove box
- 45677 PARTITION KIT for compact kart drawers h2/h3



- high drawers capacity: 20 kg (35 kg for drawer h-200-283 mm)
- centralized locking system with front key or single use seals (emergency karts only)
- 6 integrated side pockets (3+3) to hold bottles or small items
- swivelling wheels Ø 125 mm (two with brake) in thermoplastic rubber with threadguards, hub on precision ball bearings.

TECHNICAL SPECIFICATIONS

| | | |
|-----------------------------|---------------------------|--------------------------|
| Frame size: | COMPACT: 654x605xh 975 mm | MEDIUM: 804x616xh 975 mm |
| Drawer size Compact/Medium: | Front width/height | Inner sizes |
| small h1= 1/10 | 490/640xh 64 mm | 432/582x448xh 58 mm |
| medium h2= 2/10 | 490/640xh 137 mm | 432/582x448xh 131 mm |
| large h3= 3/10 | 490/640xh 210 mm | 432/582x448xh 204 mm |
| folder holders h4= 4/10 | 490/640xh 283 mm | 432/582x448xh 270 mm |



Defibrillator holder shelf with strap

Infusion stand holder has safety anti-release system and 2 kg capacity per hook. Made in chrome-plated steel.

- 45665 EMERGENCY COMPACT KART - 5 drawers - red
- 45666 EMERGENCY COMPACT KART - 4 drawers - orange
- 45667 EMERGENCY MEDIUM KART - 5 drawers - red
- 45668 EMERGENCY MEDIUM KART - 4 drawers - orange
- Size: 804x616xh 975 mm
- Holder for cylinders
- Supplied with infusion stand holder 4 hooks, Ø 120-150 mm
- defibrillator holder tray, cylinder holder (double for 45667/8) and CPR board (only 45666/8).
- 27473 DISPOSABLE SEALS - box of 100
- 27474 DISPOSABLE NUMBERED SEALS - box of 100



Slim LED X-ray illuminator viewing area 42x36 cm. See other specifications at page 144, code 44700.



Folder holders

- 45671 VIEWER KART Compact kart with slim LED viewer, 2 small drawers and 2 folder holders.
- 45672 VIEWER KART 2 Compact kart with slim LED viewer, 2 small and 1 medium drawers, 10 compartments for folders (44x48xh 43,8 cm).



Upper drawers with 14 compartments (9+5)

- 45656 PEDIATRIC KART Pediatric compact kart with 2 medium and 2 large drawers.
- 45657 UPPER DRAWERS (9+5)



- 45674 MULTIPURPOSE KART Compact kart with 2 small drawers and 2 folder holders.
- 45675 UPPER DRAWERS (9+5)
- 45678 HANGING FILE FOLDERS*

45650 PERSONALIZED KART: CONFIGURATE YOUR KART SELECTING COLOUR, DRAWERS AND MODEL - available in 45 days

| | | | | |
|-------------------|--------------|----------------|-------------------|----------------------|
| Available drawers | Small 1/10 h | Medium 2/10 h | Large 3/10 h | Folder holder 4/10 h |
| Available colours | Red RAL3020 | Orange RAL2004 | Turquoise RAL5018 | Blue RAL5010 |

You can choose your drawers considering:
- interchangeable position of drawers
- sum of selected drawers should be 10/10 h

| | | |
|-------------------|---------------|----------------|
| Ceil blue RAL5012 | Green RAL6018 | Yellow RAL1021 |
|-------------------|---------------|----------------|

* Box of 25 hanging file folders 365 x 240 mm

PAINTED OR STAINLESS STEEL MODULAR TROLLEYS SYSTEM



MODULAR TROLLEYS SYSTEM

Modular trolleys made of painted steel or stainless steel, one-piece structure, with wide technopolymer plastic worktop with borders on 3 sides to be cleaned easily, no sharp corners, ergonomic tubular push-handle.

Different drawers (small-yellow, medium-blue, large-red), depending on model, with epoxy painted panels and

integrated handle grip, silent sliding with end-run block. Possibility to remove the drawers from the guides for an easy cleaning and disinfection. Central lock key. Overall bumpers and 4 antistatic 125 mm castors, 2 with brakes. Size: 67x63x104 cm. Weight: 53 kg. Made in Italy.

Personalization for minimum 10 pcs: drawers in your colour.

| Painted | Stainless steel | TROLLEYS |
|---------|-----------------|---|
| 45600 | 45620 | Trolley with 7 small drawers |
| 45601 | 45621 | Trolley with 1 small, 3 medium drawers |
| 45602 | 45622 | Trolley with 2 small, 1 medium, 1 large drawers |
| 45603 | 45623 | Trolley with 1 small drawer, 1 compartment with shelf |
| 45604 | 45624 | Trolley with 2 medium, 1 large drawer |

ACCESSORIES FOR ALL MODULAR SYSTEM TROLLEYS

| | |
|-------|--|
| 45640 | IV stand |
| 45641 | Upper drawers (5 medium + 4 large) |
| 45644 | Partition h 4 cm for yellow drawer (49x48x10 cm) |
| 45645 | Partition h 14 cm for blue drawer (49x48x20 cm) |
| 45646 | Partition h 20 cm for red drawer (49x48x30 cm) |



WASH-BASIN - PUMP

45410 WASH-BASIN PUMP SYSTEM - white

Automatic wash-basin with round bowl in satin stainless steel, non-connected to the water mains. The system ensures the availability of water when it is expensive or impossible to lay drain-pipes in the walls or floors.



Dimensions:
47x54xh 86 cm

It only requires a 230V power socket: the low voltage transformer (12V) drives a pump for supplying water by a simple pressure of the foot on the base.

Equipped with 2x20 litre tanks for water supply and drain

UTILITY TROLLEY



45595

Blue Avio RAL 5014 available in stock

45595 UTILITY TROLLEY - blue avio 45597 UTILITY TROLLEY - other colours*

| RAL 5010 | RAL 2003 | RAL 6019 | RAL 1013 | RAL 3020 |
|----------|----------|----------|----------|----------|
|----------|----------|----------|----------|----------|

*Available in 30 days. Minimum order 5 pcs.

Smart and strong steel structure painted with epoxy powder. Technopolymer plastic one-piece top with border, without sharp corners, with compartment for accessories. Ergonomic push handle. 3 medium drawers 45.1x48.5xh 15 cm and 1 large drawer 45x49.5xh 22.5 cm with silent sliding and end-run block. Central lock key. Size: 60x50xh 100 cm Overall bumpers and 4 antistatic 125 mm swivelling castors, 2 with brake. Made in Italy.



45597 Utility trolleys other colours available in 30 days

MULTI-PURPOSE WALL UNITS

Multi-purpose wall unit to organize dispensers of disposable products. All components and slots are modular and can be organized to match professional user needs. Available in 2 sizes: standard (103x20xh 40 cm) and large (153x20xh 40 cm) and 8 colours. Melamine particle board door with vertical opening. Supplied with automatic soap dispenser, cups dispenser and 5 (standard) or 7 (large) slots.

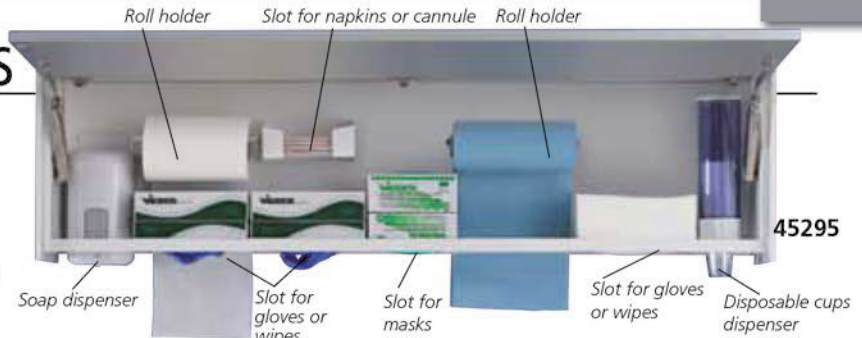

| STANDARD ACCESSORIES | 45290 | 45295 | 45293 | 45298 |
|-------------------------------|-------|-------|-------|-------|
| Dispenser for disposable cups | 1 | 1 | | |
| Automatic soap dispenser | 1 | 1 | | |
| Slot for gloves or wipes | 2 | 3 | | |
| Slot for masks | 1 | 1 | | |
| Slot for napkins or cannula | - | 1 | | |
| Roll holder | 2 | 2 | | |

| Model | MULTIFUNCTIONAL WALL UNITS | | | | | | | |
|----------|----------------------------|------------|------|--------------|--------|------|-------|--------|
| | white | light blue | grey | oyster white | yellow | blue | green | orange |
| Standard | 45290 | | | | 45293* | | | |
| Large | 45295 | | | | 45298* | | | |

*Available in 60 days, please specify colour with order

GIMA WORKTOPS AND MOBILE UNITS



The key principle in the design of this system is a total separation of the work surface (fixed) from the mobile units. The worktop set in a fixed position allows to bring together all electric and electronic wiring, as well as plumbing and water-pipes into a single location. The work surface remains free to place instruments and electric appliances, can incorporate a sink and serves as a desk. All mobile containers have wheels and are the dynamic part of the system. They can be easily placed under the work surface, or moved by the user wherever needed in the working environment. Units are interchangeable and can be freely moved between rooms. Work surfaces are made in a waterproof material covered with a high-quality melamine particle board, which ensures long durability, scratch and wear resistance. A range of 4 containers, in 8 different colours with ergonomic full-length handles. Made in Italy.

| code | STANDARD WORKTOPS - WHITE |
|-------|------------------------------------|
| 45300 | Worktop 180 cm - right washbasin |
| 45301 | Worktop 180 cm - left washbasin |
| 45302 | Worktop 180 cm - without washbasin |
| 45303 | Worktop 232 cm - right washbasin |
| 45304 | Worktop 232 cm - left washbasin |
| 45305 | Worktop 232 cm - without washbasin |

| code | ACCESSORIES |
|-------|-------------------------------------|
| 45401 | Tray 33x43.5xh6.5 cm |
| 45402 | 3-compartment tray 33x43.5xh6.5 cm |
| 45403 | 11-compartment tray 33x43.5xh6.5 cm |
| 45405 | Chromed mixer tap |



| Model | MOBILE UNITS | | | | | | | |
|-------|--------------|------------|------|--------------|--------|--------|-------|--------|
| | white | light blue | grey | oyster white | yellow | blue | green | orange |
| S1 | 45350 | 45360 | | | | 45390* | | |
| S5 | 45353 | 45363 | | | | 45393* | | |
| S9 | 45356 | 45366 | | | | 45396* | | |
| S10 | 45357 | 45367 | | | | 45397* | | |

*Available in 60 days, please specify colour with order

1 OR 3 ENGINES GYNAECOLOGICAL CHAIRS AND STOOLS

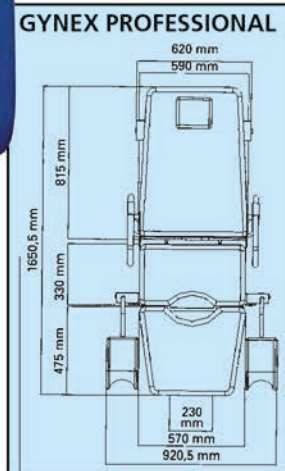
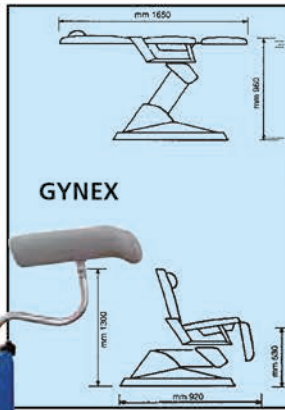

GYNEX PROFESSIONAL
with 3 engines



GYNEX - GYNAECOLOGICAL CHAIR
GYNEX: a chair offering a unique combination of functional, aesthetic and working characteristic. Thanks to its self-balancing seat and backrest, GYNEX can be adjusted to any build for the greatest patient comfort. The chair is provided with an electromechanical lifting device, having a power supply at 24 V. The electric actuators enable the movement up and down from 57 cm off the floor ("0" position) up to a maximum of 96 cm. The backrest is supplied with adjustable headrest and paper roll holder. The legrest can be independently adjusted and it has an automatic-locking device. The chair can be flattened to a bed position for examination activity, the armrest can be removed and independently oriented. The electric control of the chair for upright position is operated by means of a foot pedal. Made in Italy.

GYNEX PROFESSIONAL - GYNAECOLOGICAL CHAIR
Gynex professional chair offers functionality, aesthetics, ergonomics. It can satisfy all patient and user needs for a professional gynaecologic visit. Gynex professional is provided with versatile accessories: back paper-roll dispenser, metal basin, leg-supports. 3 engines allow, in addition to lifting, electric backrest and legrest movements. The combined movement of backrest and seat by means of self-balancing system (operated by a silent low tension actuator of 2,500 N) grants maximum comfort to the patient. The padded and pelted armrests allow a relaxing protecting sitting position, armrests are individually revolving and removable. Backrest is provided with removable height-adjustable headrest. The wide and soft backrest has independent adjustment movement through silent low tension actuator. This chair is moved by a silent low tension engine which allows a vertical excursion of 40 cm from zero position. The electrical drives are controlled by an ergonomic hand switch control, connected to the chair by a cable. Gynex professional can be easily transformed into an examination bed (horizontal position). Made in Italy.

TECHNICAL SPECIFICATIONS

| | GYNEX | GYNEX PROFESSIONAL |
|-----------------------|--|--------------------|
| Power supply tension: | 230V - 50 Hz (110V - 60 Hz on request) | 24 V |
| Motor tension: | 24 V | 24 V |
| Lifting motor push: | 6,000 N | 6,000 N |
| Backrest push: | 800 N (gas spring) | 2,500 N (motor) |
| Legrest motor push: | - | 2,500 N |
| Lifting capacity: | 180 kg | 180 kg |
| Maximum power: | 90 VA | 90 VA |
| Fuses protection: | 1.6 A | 1.6 A |

GYNEX CHAIRS AND STOOLS

| | Light blue Parigi | Green Toronto | Blue Chicago | Orange Rotterdam | Metal Apricot | Metal Sea blue | Colour on request | |
|--------------------|-------------------|---------------|--------------|------------------|---------------|----------------|-------------------|--|
| Gynex professional | 27514 | 27512** | 27513 | 27512** | 27515 | 27512** | 27512** | |
| Gynex | 27521 | 27522 | 27523 | 27524 | 27525 | 27526 | 27520** | |
| Stool with ring | 27531 | 27532 | 27533 | 27534 | 27535 | 27536 | 27530** | |
| Stool without ring | 27527 | 27528** | | | | | | |

**Available in 60 days, specify colour with order

COLOUR ON REQUEST: CLASSIC COLOURS

| | | | | | | | | |
|-----------------|--------------|-----------------|---------------|----------------|---------------|--------------|---------------|-----------------------|
| White Helsinki | Beige Roma | Beige Tunisi | Brown Perugia | Yellow Parma | Orange Praga | Red Mosca | Pink Malaga | Bordeaux Bangkok |
| Green New Delhi | Green David | Green Melbourne | Green Irlanda | Green Honolulu | Green Caracas | Violet Nizza | Violet Ankara | Light blue Palm beach |
| Blue Berna | Blue Baltico | Blue Anversa | Grey Oslo | Grey Amburgo | Grey Londra | Black Odessa | | |

COLOUR ON REQUEST: METALLIC COLOURS

| | | | | | | | | |
|-----------|--------------|--------------|------------|-------------|-----------|----------------|------------|-----------------|
| Metal Ice | Metal Silver | Metal Bronze | Metal Gold | Metal Lemon | Metal Red | Metal Sky Blue | Metal Blue | Metal Dust Grey |
|-----------|--------------|--------------|------------|-------------|-----------|----------------|------------|-----------------|



STANDARD ACCESSORIES

| | GYNEX | GYNEX PROFESSIONAL |
|--------------------------------------|-------------|--------------------|
| Poliuretane leg-rest | • | • |
| Padded leg-rest (colour coordinated) | • | • |
| Paper-roll holder | • | • |
| Basin | • (plastic) | • (metal) |
| Remote control | • | • |

STOOL - with or without ring

For professional use, completely built in stainless steel, 360° pivoting self-braking castors, rubber-tyred. Height can be comfortably adjusted by means of a gas pump; back-rest is 180° revolving and depth-adjustable. Seat is balanced density padded and Peltex-lined. Made in Italy.

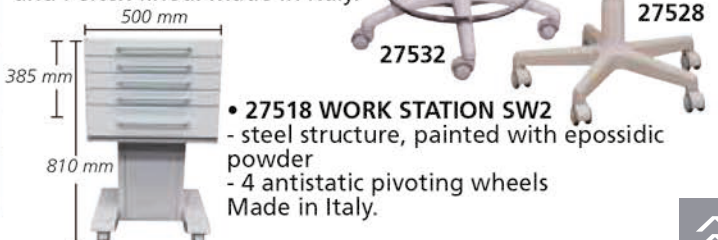

• **27518 WORK STATION SW2**
- steel structure, painted with epossidic powder
- 4 antistatic pivoting wheels
Made in Italy.

GYNAECOLOGICAL AND DELIVERY BEDS



Size: 180x55xh 80 cm
Seat size: 55x55 cm
Delivered in kit form.

27501

Standard leg holders



27503

Quality leg holders



27504

Standard and quality leg holders have 360° rotation



Size: 180x55xh 80 cm.
Delivered in kit form.

27510

- 27500 DELUXE GYN BED - quality leg holders
 - 27501 GYNAECOLOGY BED - standard leg holders
- Strong chrome-plated structure. Rectangular steel tube. Adjustable head and leg sections. Simulated leather, black colour, washable upholstery, self extinguishing. Load: 100 kg. Complete with s/s bowl Ø 31 cm and leg-holders. Made in Italy.
- 26586 S/S BOWL Ø 31 cm - spare

- 27510 DELUXE DELIVERY BED - quality leg holders
- Same as 27500, but with three sections with independent controls and Trendelenburg position. Load: 120 kg.
- 27503 STANDARD LEG HOLDERS - couple - spare
 - 27504 QUALITY LEG HOLDERS - couple - spare
- Kit leg holders includes 2 leg-holders and arms.
- 27418 COUCH ROLL HOLDER

3-SECTION MULTIFUNCTIONAL AND GYNAECOLOGICAL BEDS



LOAD 150 KG

27505

Fully adjustable standard leg holder, turnable 360° (27508)

Seat: 50x60 cm

Size: 181x60xh 83 cm
Delivered in kit form.

- 27502 3-SECTION MULTIFUNCTIONAL BED - blue
 - 27505 3-SECTION GYNAECOLOGICAL BED - blue
- Strong and stylish structure in oval tube 50x25 mm, painted with epossidic powder, metallic grey colour. The three sections top has high density padding, covered with washable, fire proof, leatherette material Class 1 IM. Back-rest and leg-rest section are fully adjustable by self mechanical sytem. Gynaecological bed is supplied with 2 foam padded leg holders and stainless steel bowl Ø 32 cm. Maximum load: 150 kg - Weight: 36 kg. Made in Italy.



27502

Size: 185x60xh 85 cm

Delivered in kit form

Seat: 62x60 cm

- 27508 STANDARD LEG HOLDER - couple - spare
 - 27509 QUALITY LEG HOLDER - couple
- Kit leg holder, includes 2 leg-holders and arms.
- 27511 COUCH ROLL HOLDER for 27502-5
 - 27919 DESK with 2 drawers - 130x71xh 80 cm
- Strong structure in oval tube 40x20 painted with epossidic powder, metal grey colour. White work top with rubber edge and round corner.
- 27979 FOOT STOOL - 2 steps



27919



27979



27538

3-SECTION DELIVERY BED WITH TRENDELENBURG

Height adjustable leg holder, turnable 360°

- 27538 3-SECTION DELIVERY BED - with Trendelenburg
- structure made of epoxy painted oval steel tube
 - three sections with independent control and Trendelenburg position
 - padding made of high density polyurethane foam, fireproof Class 1 IM
 - covering made of washable, plastic material (leatherette) fireproof Class 1 IM
 - adjustable rubber feet

Size: 181x60xh 80 cm
Carton size: 75x20xh 196 cm.
Maximum load: 150 kg.
Net weight: 43 kg.

Supplied with a pair of height-adjustable, padded, anatomic leg-holders, a couple of shoulder rests, handgrips, a paper roll holder and a stainless steel basin Ø 32 cm. Delivered in kit form.

Made in Italy.

- 27509 QUALITY LEG HOLDER - couple

DONOR ARMCHAIR

- 27557 DONOR ARMCHAIR - blue - mechanical
- 27563 DONOR ARMCHAIR - blue - electrical
- 27567 DONOR ARMCHAIR WITH WHEELS - white

Strong and stylish armchair with structure made with oval, round and square metal section tubing (legs oval tubing 50x25x1.5; central frame square tubing 30x30x1.5, cushions round tubing 20x1.5 diam.). Structure fully coated with white epoxy powder. High density polyurethane foam platform with wooden base covered by leatherette upholstery. Both materials are flame resistant Class 1 IM. Synchronized adjustment of the two cushions by a gas spring, cylinder/piston, (27557, 27567) or by a linear actuator (27563) with a push-button panel, allow a quick moving into TR/RTR position. The backrest inclination ranges from +60° to -5° in Trendelenburg position, leg rest from -80° to +5°.

The arm-rests can be height adjusted and are reclinable. When removed, they can be rotated up to 180°. Four adjustable feet ensure maximum stability (27557 and 27563) or 4 castors, 2 with directional brake (27567) ensure mobility. Load: 150 kg. Size: 175x55xh 51 cm. Made in Italy.

- 27553 IV STAND
- 27556 COUCH ROLL HOLDER



27557



27557

White ral colour 9003 structure, minimum thickness 70/80 micron. Glossy finish.



WITH WHEELS



27567



27563

ELECTRICAL



DONOR WHEELCHAIR

- 27561 DONOR WHEELCHAIR

Donor wheelchair with structure made of epoxy painted oval and round steel tube. Backrest adjustable by gas pump. Padded leg rest manually adjustable. Metal footrest extractable. Armrest with articulations, manually adjustable in height. Padding made of high-density polyurethane foam, fireproof Class 1 IM. Covering made of washable, plastic material (leatherette), fireproof Class 1 IM. Back push handle.

Mattress overall size: 166x55 cm. Carton size: 185x67xh 58 cm. Four wheels Ø 100 mm, 2 directional and 2 with brake. Net weight: 53 kg. Gross weight: 55 kg. Maximum load: 150 kg. Supplied with blanket tray with belts to fix oxygen bottle, IV stand and chart holder support. Made in Italy.



Chart holder support



27561

Blanket tray with belts to fix oxygen bottle (bottle not included)

HEIGHT ADJUSTABLE GYNAECOLOGICAL BED

- 27506 HEIGHT ADJUSTABLE GYN BED - green
- 27507 HEIGHT ADJUSTABLE GYN BED - blue
- 27496 HEIGHT ADJUSTABLE GYN BED - any colour*

*Available in 20 days, see below available colours

Strong and solid structure in oval tube 50x25x2 mm painted with epoxy powder, white colour. The three sections top has high density padding, covered with washable, fire proof, leatherette material class 1 IM.

Full adjustable

Height, up to 95 cm, is adjustable by electric engine (6000 N power) with foot control, head section is adjusted by a gas cylinder (400 N power), central section by a gas cylinder (600 N power) up to 65°. This gyn bed is supplied with 2 quality foam leg holders, stainless steel tray and couch roll holder.

Maximum load: 150 kg. Weight: 70 kg. Made in Italy.

- 27509 QUALITY LEG HOLDER - couple - spare
- Kit leg holder includes 2 leg holder and arms. Suitable for 27496, 27505, 27506, 27507.

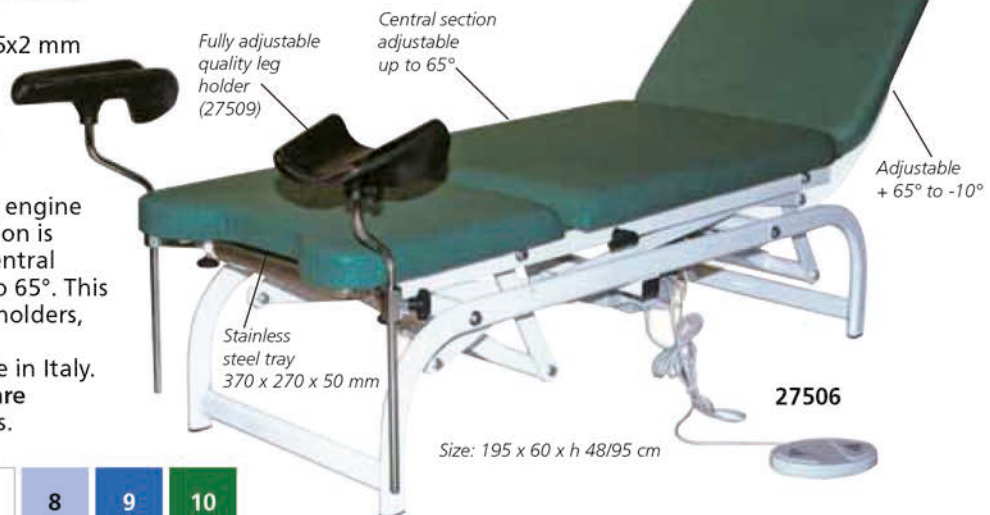

Fully adjustable quality leg holder (27509)

Central section adjustable up to 65°

Adjustable + 65° to -10°

Stainless steel tray 370 x 270 x 50 mm

27506

Size: 195 x 60 x h 48/95 cm

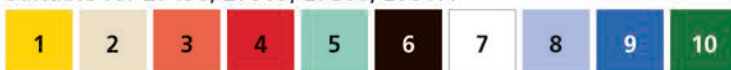

ENT CHAIRS

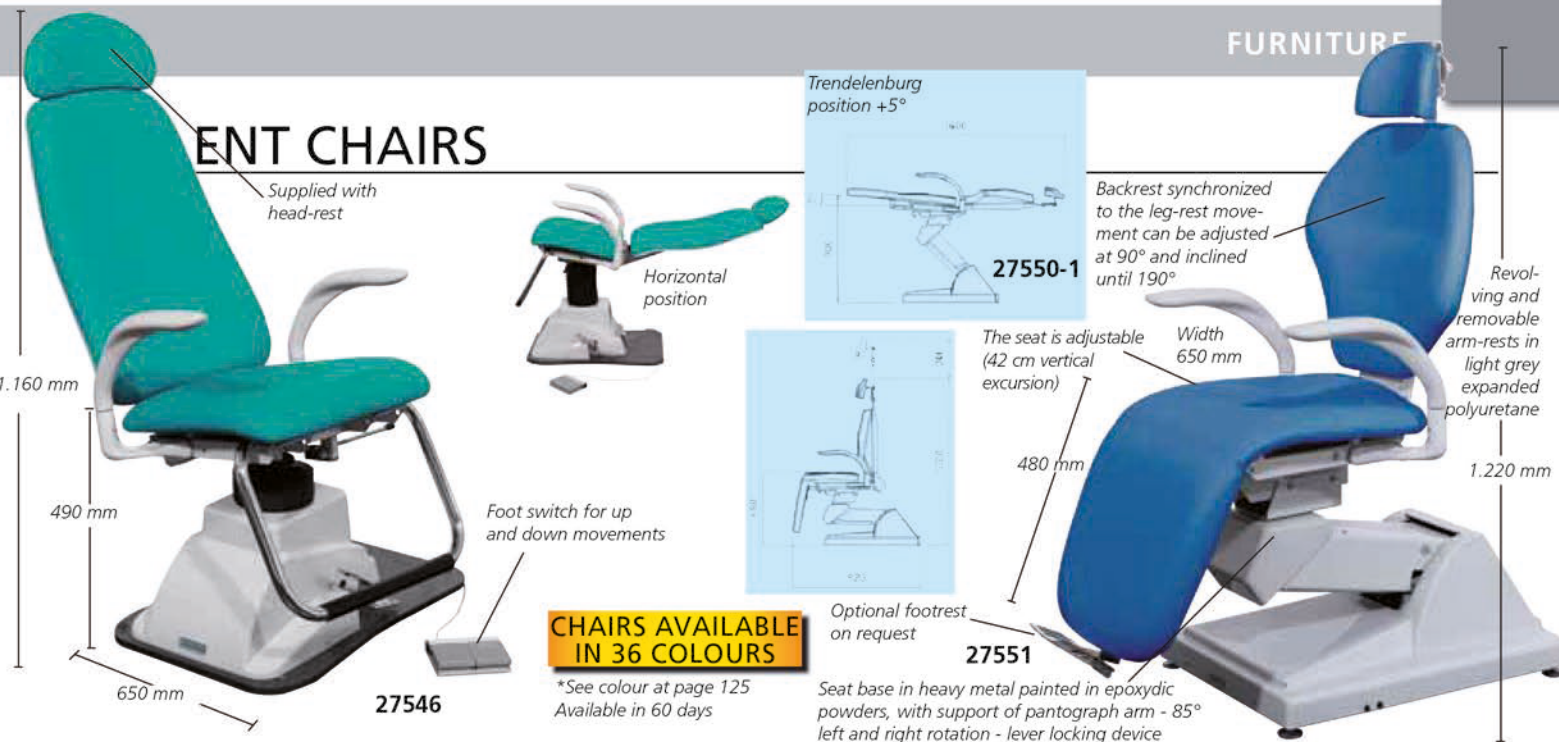

- 27545 OTO/PV ENT CHAIR with head support - colour on request*
- 27546 OTO/PV ENT CHAIR with head support - green Melbourne
- 27547 OTO/PV ENT CHAIR with head support - sky blue Parigi

Patient chair with Peltex-lined seat and backrest. Electric up and down movements by silent engine controlled through foot switch. Back-rest can be adjusted up to 180° by a gas spring. Chair rotates 360° and is provided with a rotation locking device placed at the bottom. Power: 230 V - 50 Hz (Available 110 V - 60 Hz). Made in Italy.

- 27550 OTOPEX ENT CHAIR with head support - colour on request*
- 27551 OTOPEX ENT CHAIR with head support - blue Chicago
- 27552 OTOPEX ENT CHAIR with head support - green Toronto

ENT chair designed also for ambulatory operations. Moved by very silent electrical engines operated by joystick foot-control. Also provided with button to re-set to previously selected working position. Upholstery made of simulated leather, high density undeformable foam padding (50 kg/cm³). Seat and leg-rest are joined in a single piece. Power: 230 V - 50 Hz (Available 110 V - 60 Hz). Made in Italy.

ENT CABINETS

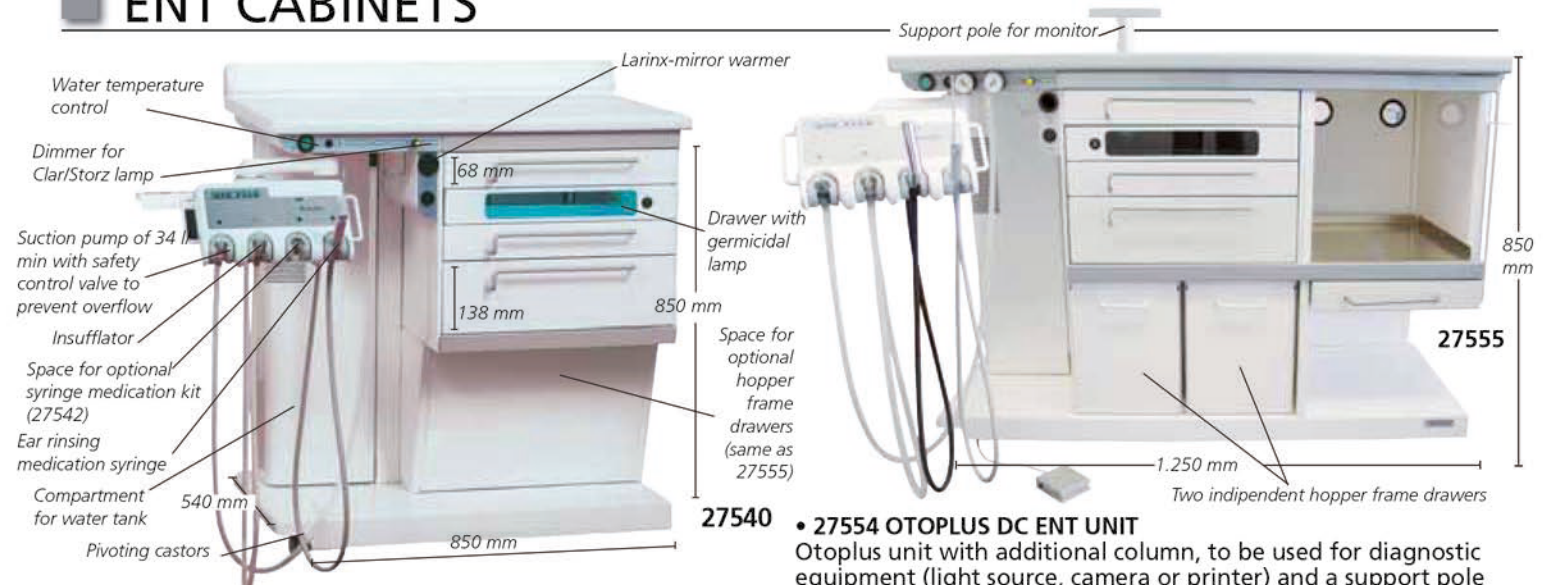

- 27540 OTOPLUS - ENT UNIT

The E.N.T. unit has rubber pivoting castors, a working surface made of scratch-proof rolled sections, 2 small and one large drawers provided of removable internal partitions, one drawer with inside germicidal lamps to keep instrument sterilization. Otoplus is provided with a silent suction pump of 34 l/min, with power supply complete with dim adjustment device for Clar/Storz lamp, larynx-mirror warmer, twin-cylinder dry compressor for tubal insufflation, 2-litres distilled water tank with acoustic signal for reserve level. The articulated arm with instrument holding tray is complete with terminal suction cannula and terminal insufflation cannula, ear rinsing syringe with automatic water temperature control, (a microprocessor keeps temperature at a constant level of 37 °C). Power 230 V - 50 Hz (Available 110 V - 60 Hz). Made in Italy.

- 27539 OTOPLUS COMPLETE

Same as code 27540 with included vasister drawers (code 27541) and endoscope support (code 27543).

- 27554 OTOPLUS DC ENT UNIT

Otoplus unit with additional column, to be used for diagnostic equipment (light source, camera or printer) and a support pole for monitor.

- 27555 OTOPLUS DC ENT UNIT - complete

Same as code 27554 with included hopper frame drawers (code 27541) and endoscope support (code 27543)

- 27541 HOPPER FRAME DRAWERS - 2 independent drawers
- 27543 ENDOSCOPE SUPPORT - 2 transparent plastic tubes 1 tube 50 cm long and 1 tube 25 cm long both closed at the bottom.
- 27542 SYRINGE MEDICATION KIT composed of 1 syringe, 2 atomizers (1 for liquid and 1 for powder) and 3 ampoules in dark glass. To be ordered with ENT unit.
- 27544 LED LIGHT SOURCE

Makes cold white light (5500 °K, 200 lumen) for endoscopy use. It can be connected to endoscopes without need of F.O. cable. Handle connect directly to rigid endoscopes (Storz connection). Size: 30x25x12 cm

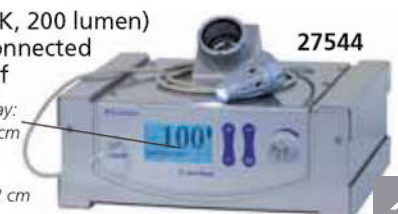

HYDRA PODOLOGY CHAIR - MADE IN ITALY

- 28033 HYDRA PODOLOGY CHAIR - green David
- 28035 HYDRA PODOLOGY CHAIR - any colour*

Functional and compact podiatry chair. The up/down movement, activated by a foot switch is synchronized to the seat inclination in order to easily lift the patient foot to the optimal working position, allowing the operator to keep the correct posture during the whole therapy. One silent electric actuator activates the up/down movement allowing a vertical lift range of 40 cm (min height

55 cm/max height 95 cm). Combined to the seat inclination movements, it permits the heel rest to reach the height of 120 cm from the floor. The backrest is manually adjustable to 180° through a powerful gas spring. The upholstered ergonomic parts grant high comfort to the patient. The double legrests swivel horizontally and the extendable heel rest holds the foot in various working positions. Comfortable padded arm rests. Lifting capacity: 180 kg. Chair's weight: 80 kg. Power supply: 230 V - 50/60 Hz.



28033

| COLOUR ON REQUEST: CLASSIC COLOURS* | | | | | | | |
|--------------------------------------|-----------------------|-----------------|---------------|----------------|---------------|------------------|--------------|
| White Helsinki | Beige Roma | Beige Tunisi | Brown Perugia | Yellow Parma | Orange Praga | Red Mosca | Pink Malaga |
| Bordeaux Bangkok | Green New Delhi | Green Melbourne | Green Irlanda | Green Honolulu | Green Caracas | Orange Rotterdam | Violet Nizza |
| Violet Ankara | Light blue Palm beach | Blue Berna | Blue Baltico | Blue Anversa | Grey Oslo | Grey Amburgo | Grey Londra |
| Black Odessa | Light blue Parigi | Green Toronto | Blue Chicago | | | | |
| COLOUR ON REQUEST: METALLIC COLOURS* | | | | | | | |
| Metal Ice | Metal Silver | Metal Bronze | Metal Gold | Metal Lemon | Metal Red | Metal Sky Blue | Metal Blue |
| Metal Dust Grey | Metal Apricot | Metal Sea blue | | | | | |

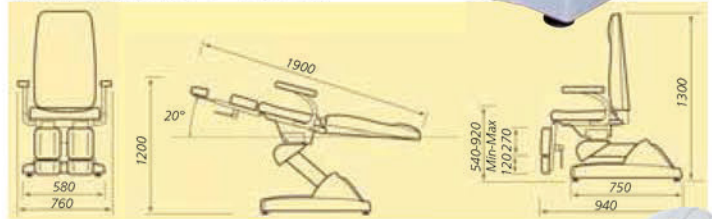

*Available in 60 days, specify colour with order

PODOLOGY CHAIRS

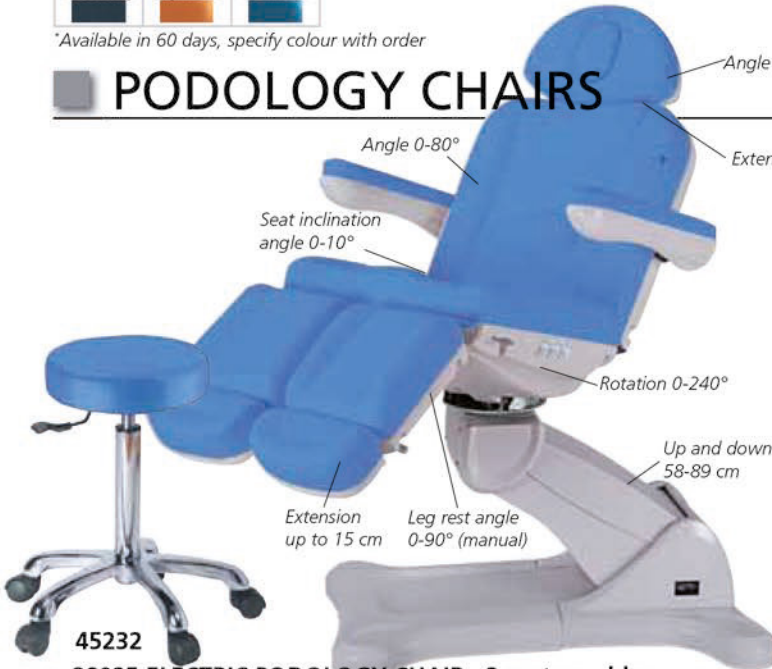

45232

- 28025 ELECTRIC PODOLOGY CHAIR - 3 motors - blue
Electrically controlled chair to independently adjust height, backrest and seat inclination, by foot switch or push button panel. Head rest can be inclined, arm rests are movable. Operating power: 220-240 V - 50/60 Hz. Size: 186x56x58/89 cm. Maximum load: 170 kg. Net/Gross Weight: 83/96 kg
- 45232 STOOL - blue
- 45242 STOOL WITH BACKREST - blue



28020

- 28020 PODOLOGY CHAIR - mechanical - white
This chair can move up and down and rotate. Backrest and footrests are adjustable. Heavy round base provides maximum stability. Size: 180x80xh 51/65 cm. Maximum load: 170 kg. Weight: 41 kg
- 45231 STOOL - white
- 45241 STOOL WITH BACKREST - white

GAMMA/PODOLOGICAL CABINETS - MADE IN ITALY

- 28030 GAMMA1 CABINET - 61x45xh 77 cm - small
 - 28031 GAMMA3 CABINET - 108x45xh 77 cm - large
- Practical service cabinet, equipped with tabletop in scratch-resistant wood, drawers and doors, specifically designed to keep tools and accessories sterile. Base with castors to facilitate movement. Supplied with connections to the mains: germicide compartment, lampholder and other electric sockets. Power supply: 220 V - 50/60 Hz.

| | SIZES | | | | Germicide compartment | Large compartment |
|---------|---------|--------|-----------|--------|-----------------------|-------------------|
| | Cabinet | 28031 | Table top | 28031 | | |
| Length: | 61 cm | 108 cm | 61 cm | 108 cm | 28 cm | 28 cm |
| Width: | 45 cm | 45 cm | 42 cm | 42 cm | 38 cm | 28 cm |
| Height: | 77 cm | 77 cm | | | 4 cm | 15 cm |

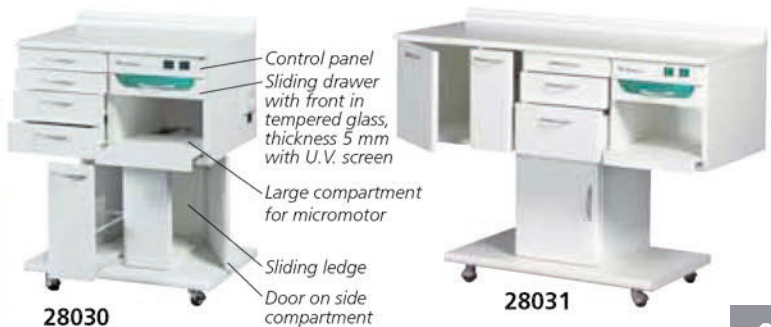

28030

28031

ELECTRIC CHAIRS WITH FOOT CONTROL - 3 MOTORS



45244

28040

- 28040 CLEOPATRA ELECTRIC CHAIR - 3 motors - beige
Electrically controlled 3 motors chair to adjust separately height, backrest and seat inclination by foot switch or push button panel. Footrest adjustable by gas lift pump. Reversible arms and adjustable headrest. Operating power: 220-240 V - 50/60 Hz.
- 45234 STOOL - beige
- 45244 STOOL with backrest - beige



45233

28045

- 28045 NEFERTITI ELECTRIC CHAIR - 3 motors - green
Electrical chair with very stable structure and high comfort. Specially designed to optimize the workspace due to 240° rotation. 3 motors control height, backrest and seat inclination by foot switch or push button panel. Footrest adjustable by gas lift pump, reversible arms and adjustable headrest. Operating power: 220-240 V - 50/60 Hz.
- 45233 STOOL - green
- 45243 STOOL with backrest - green

PROFESSIONAL MECHANICAL AND ELECTRIC CHAIR

Size: 185x85xh 56-75 cm
Net weight: 72 kg
Max load: 170 kg



45241

28005

- 28005 LUXOR CHAIR - mechanical - white
- 28006 LUXOR CHAIR - mechanical - blue
Chair can move up and down and rotate 360°. Backrest and footrest are adjustable.

28005/28006

STOOLS

- 45231 STOOL - white
- 45232 STOOL - blue

STOOLS with backrest

- 45241 STOOL - white
- 45242 STOOL - blue
See page 141.

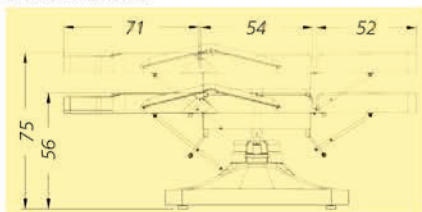

Size: 186x88xh 71-96 cm
Net weight: 75 kg
Max load: 170 kg



45232

28011

- 28010 LUXOR ELECTRONIC CHAIR - 3 motors - white
- 28011 LUXOR ELECTRONIC CHAIR - 3 motors - blue
Electrically controlled chair to adjust separately height, backrest or footrest. Hand and foot control. Armrest and headrest are flexible. Operating power: 220-240 V - 50/60 Hz. Available on request 100-120 V.



28010

GIMA ADJUSTABLE HEIGHT ELECTRIC TABLE

- 27632 GIMA TREATMENT TABLE - any colour**
- 27633 GIMA TREATMENT TABLE - blue
- 27634 GIMA TREATMENT TABLE - cream
- 27628 GIMA TREATMENT TABLE - green
- 27635 GIMA TREATMENT TABLE - black

AVAILABLE IN 6 COLOURS

Sturdy and highly stable examination and treatment table.

Adjustable height by electric foot switch. Fixed leg-section and manually adjustable head-section with mouth-nose hole. Fire proof padding. Lifting capacity: 140 kg. Length: 193 cm. Made in Italy.

STOOLS: matching stool at page 141.

- 27629 COUCH ROLL HOLDER
- 27630 MOUTH-NOSE HOLE PLUG - any colour**
- 27631 MOUTH-NOSE HOLE PLUG - blue
- 27620 MOUTH-NOSE HOLE PLUG - cream
- 27625 MOUTH-NOSE HOLE PLUG - green
- 27621 MOUTH-NOSE HOLE PLUG - black

** Available in 15 days

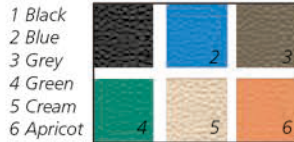

ELECTRIC OR HYDRAULIC HEIGHT-ADJUSTABLE TABLES



The padding is in medium-density foam covered with high quality fire retardant vinyl

27587

Accessibility. The laterally open frame permits the access with patient lifting system or trolleys for electrotherapy equipment.

AVAILABLE IN 24 COLOURS

WIDTH 80 cm



Sturdy frame with all moving parts having self-lubricating components to avoid early wear and noise

27595

Hydraulic version

BRUXELLES TABLES - electric or hydraulic
Examination and treatment table with high stability. Electric height adjustment by a foot-switch (low tension 24 V) or manual by hydraulic piston. Features: one mobile section, gas-spring supported adjustment of the head-section (with mouth-nose hole) and fixed leg-section. The large head-section can be adjusted positively and negatively and serves as back-rest. Safe working load 200 kg. Power 230 V - 50/60 Hz. Made in Italy.

TRENDELENBURG



27602

- 27602 THER TRENDELENBURG TABLE - electric - any colour**
- 27603 THER TRENDELENBURG TABLE - electric - blue (3)
- 27604 THER TRENDELENBURG TABLE - hydraulic - any colour**

Examination and treatment tables with electric height adjustment by a foot switch (low tension 24 V) or hydraulic height adjustment by a piston. Features: three mobile sections adjustable by gas spring. The table can easily assume the "flexion", "relax" and "trendelenburg" position even if the patient is lying on the table. The large head-section (with mouth-nose hole) can be adjusted positively and negatively. Chair position. Safe working load 200 kg. Power 230 V - 50/60 Hz. Supplied with mouth-nose hole plug. Made in Italy.

| BRUXELLES TABLES | Standard 68 cm | Large 80 cm |
|--------------------------|----------------|-------------|
| Electric - any colour** | 27587 | 27595 |
| Electric - blue | 27588 | - |
| Hydraulic - any colour** | 27589 | 27596 |

** Available in 30 days

| code | ACCESSORIES FOR ALL TABLES |
|-------|---|
| 27590 | Couch roll holder for rolls 50 to 63 cm |
| 27591 | Wheels set |
| 27594 | Mouth-nose hole plug - any colour** for 27587-9, 27595-6, 27582-4 |

** Available in 30 days



Wheels set - optional

Upholstery colour code



KING HEIGHT ADJUSTABLE EXAMINATION COUCH

- 27613 KING HEIGHT ADJUSTABLE EXAMINATION COUCH - blue - 9
- 27612 KING HEIGHT ADJUSTABLE EXAMINATION COUCH - any colour*

*available in 20 days, see below available colours

Height adjustable (48-95 cm) examination couch by electric actuator (Linak engine 6.000 N) controlled by foot switch with head section easily adjustable (to +60° and -10°) by a gas pump. Strong and stylish leg structure in oval tubing 50x25x2 mm, central frame in rectangular tubing 50x20x1.5 mm painted with RAL 9003 white epoxy powder. Minimum thickness 70/80 micron, glossy finish. High density polyurethane foam platform with wooden base covered by leatherette upholstery. Both materials are flame resistant Class 1 IM. Leatherette washable with the most common detergents. Couch roll holder included. Maximum load: 150 kg. Made in Italy.



Size: 190x60xh 48/95 cm
Weight: 70 kg



27613



VARIABLE HEIGHT EXAMINATION COUCH WITH TR/RTR

- 44510 LORD VARIABLE HEIGHT EXAMINATION COUCH - water green - 5
- 44516 LORD VARIABLE HEIGHT EXAMINATION COUCH - any colour*

*available in 20 days, see below available colours

Stable and sturdy examination couch made in high quality tubular for furniture. Very practical and user friendly. Height adjustable thanks to the two electrical columns that can move simultaneously or separately (allowing the Trendelenburg/Reverse Trendelenburg position) by a push-button panel.

Under the top frame, an ergonomic lever actions a gas spring that reclines the cushions. High density, rubber padded, fire retardant and Class 1 IM top, covered in coated fabric (vinyl, synthetic leather, flame retardant Class 1 IM).

It can be cleaned with common detergents.

Complies with: EU 93/42 CEE. Maximum load: 200 kg.

Supplied with mouth/nose hole plug, paper roll holder and 4 adjustable feet.

- 44505 RETRACTABLE/REMOVABLE WHEELS



Overall size:
194x68xh 52/94 cm
Padded top length: 190 cm
Weight: 80 kg

44510

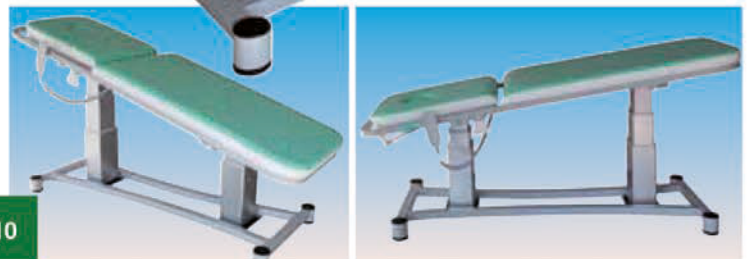

SUN 2-SECTIONS VARIABLE HEIGHT TREATMENT COUCH

- 44530 SUN 2-SECTIONS VARIABLE HEIGHT TREATMENT COUCH - orange - 3
- 44536 SUN 2-SECTIONS VARIABLE HEIGHT TREATMENT COUCH - any colour*

*available in 20 days, see below available colours

Couch made in high quality tubular that makes it very sturdy. The cushions can be reclined by a gas spring activated by an ergonomic lever under the top frame.

Head section movable to +45° and to -30°.

Height adjustable thanks to the two electrical columns by a push-button panel.

High density, rubber padded, fire retardant and Class 1 IM top, covered in flame retardant Class 1 IM coated fabric (synthetic leather).

Washable and disinfected with common detergents.

Overall size: 195x68xh 48/89 cm. Weight: 80 kg.

Complies with: EU 93/42 CEE. Maximum load: 200 kg.

Supplied with mouth/nose hole plug, paper roll holder, 2 adjustable armrests and 4 adjustable feet.

- 44505 RETRACTABLE/REMOVABLE WHEELS

- 44540 WEDGE CUSHION 50x50xh 15 cm - orange

- 44545 WEDGE CUSHION 50x50xh 15 cm - any colour*

- 44550 SEMI-CYLINDRICAL CUSHION 20x50xh 10 cm - orange

- 44555 SEMI-CYLINDRICAL CUSHION 20x50xh 10 cm - any colour*

*available in 20 days, see below available colours



Arm rest
35x13 cm

Head section
65x36 cm

44530

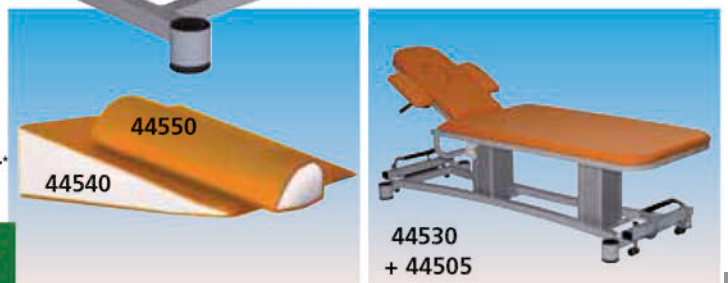

44540

44550

44530
+ 44505



KING EXAMINATION COUCH

KING EXAMINATION COUCH

Strong and stilish structure in oval tube 50x25 mm painted with metallic grey epoxy powder. Top in washable, fire proof, leatherette material class 1 IM with high density padding. Head section adjustable by mechanical system.

Maximum load: 150 kg.

Size: 190x60xh 80 cm.

Delivered in kit form.

Made in Italy.

| GIMA Code | KING EXAMINATION COUCH |
|----------------------------------|--|
| 27614 | King examination couch - water green - 5 |
| 27615 | King examination couch - white - 7 |
| 27616 | King examination couch - blue - 9 |
| 27617 | King examination couch - black - 6 |
| 44486 | King examination couch - any colour* |
| KING EXAMINATION COUCH WITH HOLE | |
| 27618 | King examination couch - green |
| 27619 | King examination couch - white |

*available in 20 days, see below available colours



27978

27979

| ACCESSORIES | |
|-------------|----------------------|
| 27511 | Couch roll holder |
| 27978 | Foot stool - 1 step |
| 27979 | Foot stool - 2 steps |



27616

27619

WIDTH: 60 cm

MAX LOAD 150 kg



KING PLUS EXAMINATION COUCH

- 44490 KING PLUS EXAMINATION COUCH - blue - 9
- 44491 KING PLUS EXAMINATION COUCH - beige - 2
- 44496 KING PLUS EXAMINATION COUCH - any colour*

*available in 20 days, see below available colours

Same as King examination couch, but with extra thick 7 cm mattress with lateral white band



1 Yellow 2 Beige 3 Orange 4 Red 5 Water green



6 Black 7 White 8 Liliac 9 Blue 10 Green



44490



44491

MAX LOAD 150 kg

ELITE EXAMINATION COUCH

- 44500 ELITE EXAMINATION COUCH - blue - 9
- 44503 ELITE EXAMINATION COUCH - any colour*

*available in 20 days, see below available colours

Stylish, comfortable and innovative examination couch available in 10 colours with lateral white band. Realized with high quality furniture tubing that guarantees stability and robustness.

The couch is made with rectangular and rounded tubing, Uni 7947/81 and 8913, DIN 2394.

Fireproof rubber padding covered with class 1 IM fireproof woven imitation leather.

Adjustable head section through 2 cogwheels.

The roll holder, included, can be placed in the feet or in the head side. 4 adjustable feet.

Size 193x68xh 78 cm. Padding size 190x68xh 7 cm.

Max. load 200 kg. Weight 70 kg.

Disassembled, very simple to assemble.

Made in Italy.

- 44505 RETRACTABLE/REMOVABLE WHEELS



LOAD 200 KG



44503



COUCH PAPER ROLLS

COUCH PAPER ROLLS

A complete range of hygienic and resistant couch paper manufactured in Italy in pure cellucotton or cellucotton/polythene. Each roll is individually packed in plastic bag for best protection. Atoxic. Available with standard 38 or 40 cm perforation or 190 cm perforation (full person size).

• 27418 COUCH ROLL HOLDER

Adjustable roll holder suitable for round (Ø 27-30 mm) or square (27-30 mm x 27-30 mm) metal couch leg.

OTHER SIZES OF COUCH ROLL PAPER AVAILABLE ON REQUEST



| MATERIAL | Cellucotton embossed | | Microembossed glued mikrogepragt verleimt - gaufré collé | | | | | | Pure wadding of cellulose ply coated with a polythene protection | | | |
|------------------------|----------------------|-----------------------|---|-----------------------|-----------------------|-----------------------|-----------------------|-----------------------|--|-----------------------------|-----------------------------|----------------------------|
| | code | 27410 | 27411 | 27412 | 27424 | 27427 | 27428 | 27432 | 27419 | 27414 | 27413 | 27415 |
| Colour | white | white | white | white | white | white | white | white | white | light blue | white | white |
| Ply | 1 ply | 2 ply | 2 ply | 2 ply | 2 ply | 2 ply | 2 ply | 2 ply | 2 ply | 14 g/m ² polyth. | 14 g/m ² polyth. | 8 g/m ² polyth. |
| Weight | 30 g/m ² | 2x20 g/m ² | 2x17 g/m ² | 2x17 g/m ² | 2x17 g/m ² | 2x17 g/m ² | 2x17 g/m ² | 2x17 g/m ² | 2x17 g/m ² | 2628 g/m ² | 2628 g/m ² | 2628 g/m ² |
| Length | 95 m | 47.5 m | 46 m | 50 m | 100 m | 50 m | 80 m | 80 m | 80 m | 50 m | 50 m | 50 m |
| Height | 50 cm | 59 cm | 50 cm | 50 cm | 50 cm | 59 cm | 59 cm | 59 cm | 59 cm | 50 cm | 50 cm | 60 cm |
| Number of sheet | 250 | 125 | 135 | 132 | 263 | 132 | 210 | 42 | 132 | 132 | 132 | 125 |
| Perforation | 38 cm | 38 cm | 34 cm | 38 cm | 38 cm | 38 cm | 38 cm | 190 cm | 38 cm | 38 cm | 38 cm | 40 cm |
| Rolls per box | 6 | 6 | 9 | 9 | 6 | 9 | 6 | 6 | 6 | 6 | 6 | 6 |

EXAMINATION COUCHES

- 27401 EXAMINATION COUCH - chromed - black
- 27402 EXAMINATION COUCH - white painted - grey
- 27444 EXAMINATION COUCH - white painted - green

STOOLS: see matching stools page 141

Suitable for medical office or small surgeries.

Easy to assemble, following enclosed instructions.

Comes complete with mattress.

Upholstery in two sections: one 130x61xh 5.5 cm fixed and a 50x61xh 5.5 cm backrest adjustable through different positions.

Delivered in kit form.

Universal couch roll holder (code 27418, not included)

• 27418 COUCH ROLL HOLDER

Adjustable roll holder suitable for round (Ø27-30 mm) or square (27-30 mm x 27-30 mm) metal couch leg.

- 27404 CLASSIC EXAMINATION COUCH - chromed - beige

- 27405 CLASSIC EXAMINATION COUCH - chromed - blue

- backrest with hole

- 27445 CLASSIC EXAMINATION COUCH - chromed - apricot

Chromed mainframe and legs constructed in chrome-plated steel. Legs fitted with plastic feet.

The two-section top has resilient foam padding covered with washable and fire-proof plastic material.

Backrest fully adjustable.

Available in beige, blue, apricot colour.

Other colours on request, minimum 10 pieces.

Size: 180x57xh 73 cm.

Maximum load 100 kg.

Delivered in kit form.

Made in Italy.

- 27408 MOUTH-NOSE HOLE PLUG for code 27405 - blue

STOOLS: see matching stools page 141

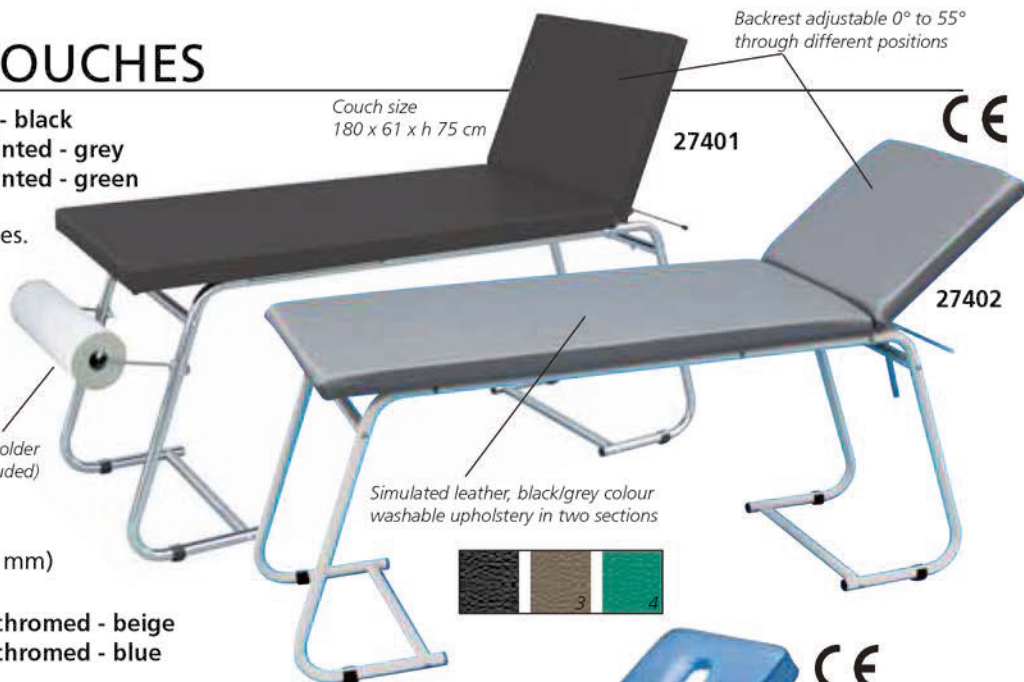

EXAMINATION AND TREATMENT TABLE - HIGH LOAD

- 27622 STANDARD TREATMENT TABLE - any colour**
- 27623 STANDARD TREATMENT TABLE - blue*
- 27624 STANDARD TREATMENT TABLE - cream*
- 27626 LARGE TREATMENT TABLE - any colour**
- 27627 LARGE TREATMENT TABLE - blue*

Professional examination and treatment table with one movable section and manual adjustment.

Sturdy detachable metal structure painted with scratch-proof, non corrosive epoxy powder.

The section trim facilitates reaching the patient.

The head section has an extended mouth-nose hole.

Load 180 kg (standard), 200 kg (large).
Made in Italy

- 27629 COUCH ROLL HOLDER
- 27630 MOUTH-NOSE PLUG - any colour**
- 27631 MOUTH-NOSE PLUG - blue
- 27620 MOUTH-NOSE PLUG - cream

* usually in stock ** available in 30 days

AVAILABLE IN 6 COLORS

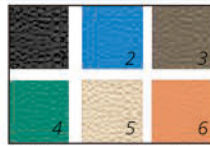

- 1 Black
- 2 Blue
- 3 Grey
- 4 Green
- 5 Cream
- 6 Apricot



27622

High-density foam padding. Superior cover finish made of high-quality fireproof simulated leather. Vinyl is resistant to disinfectants, urine, and blood.



27627

WIDTH 80 cm

MAX LOAD - 200 kg

WOODEN COUCHES

WOODEN COUCHES

Comfortable couches, ideal for physical therapy, cardiology and wellness centres. Superior quality wood. Back rest adjustable in 13 positions. Resilient foam padding covered with washable weave. Padding in beige colour.

Size: 190x70xh 70 cm.



27416



27417+27409

Mouth nose hole plug included

Maximum load: 150 kg

- 27416 WOODEN COUCH - beech
- 27417 WOODEN COUCH - with face hole - beech
- 27443 DANTE WOODEN TROLLEY - beech
- 27409 COUCH ROLL HOLDER for 27416 and 27417

Couch roll holder included with 27450 and 27451. Delivered in kit form. Easy assembly, tool provided. Made in Italy.



27451

27452
Size 50x40xh 77 cm



27450

Maximum load: 200 kg

- 27450 FIRENZE WOODEN COUCH - wenge
- 27451 FIRENZE WOODEN COUCH - with face hole - cherry wood
- 27452 DANTE WOODEN TROLLEY - cherry wood

SUITCASE COUCH

27407 SUITCASE COUCH

Chromed steel and folding legs. Upholstered covering in washable material. Resin padded. Available in black colour. Weight: 19 kg - Max load: 95 kg. Supplied with a velvet bag for easy transport. Made in Italy.



27407

Couch size:
185x64xh 70 cm (open)
95x65x16 cm (folded)

ALUMINIUM SUITCASE COUCH

27406 ALUMINIUM SUITCASE COUCH with hole (22x12)

Light, foldable, two sections, suitcase couch with aluminium frame. Central double legs for improved safety and block system on the hinges. Head rest with mouth/nose hole. Upholstered and covered with simulated leather. Maximum load: 110 kg. Weight: 13 kg. Made in Italy.



27406

Size: 62x182xh 75 cm

FOLDABLE MASSAGE TABLE - WOOD OR ALUMINIUM



WOODEN 2-SECTIONS



WOODEN 3-SECTIONS



ALUMINIUM 2-SECTIONS

- 44000 2-SECTION WOODEN MASSAGE TABLE - black
- 44001 2-SECTION WOODEN MASSAGE TABLE - blue
- 44002 2-SECTION WOODEN MASSAGE TABLE - turquoise
- 44003 2-SECTION WOODEN MASSAGE TABLE - cream

Two-section foldable height adjustable massage table with German beech wood frame and PVC vinyl cover with 5 cm foam thickness. Tables are supplied with headrest, hanged armrest, mouth-nose plug and carrying bag. Product open size: 185x70xh 62/87 cm
Packing size: 95x20xh 75 cm
Net/Gross weight: 14/17 kg
Maximum working load: 227 kg (500 lbs)
Manual: GB, FR, IT, ES, PT, DE



Carrying bag for all tables

- 44011 3-SECTION WOODEN MASSAGE TABLE - blue
- 44013 3-SECTION WOODEN MASSAGE TABLE - cream

Three-section foldable height adjustable massage table with German beech wood frame and PVC vinyl cover with 5 cm foam thickness. Tables are supplied with headrest, armrests, hanged armrest, mouth-nose plug and carrying bag. Product open size: 185x70xh 62/87 cm
Packing size: 95x20xh 75 cm
Net/Gross weight: 16/19 kg
Maximum working load: 227 kg (500 lbs)
Manual: GB, FR, IT, ES, PT, DE



- 44020 2-SECTION ALUMINIUM MASSAGE TABLE - black
- 44021 2-SECTION ALUMINIUM MASSAGE TABLE - blue
- 44024 2-SECTION ALUMINIUM MASSAGE TABLE - white

Two-section foldable, height adjustable massage table with aluminium frame and PVC vinyl cover with 5 cm thickness. Tables are supplied with headrest, side armrests, hanged armrest, mouth-nose plug and carrying bag. Product open size: 186x70xh 59/80 cm
Packing size: 95x20xh 75 cm
Net/Gross weight: 13/16 kg
Maximum working load: 200 kg (440 lbs)
Manual: GB, FR, IT, ES, PT, DE



MASSAGE BED WITH HOLE

- 27421 MASSAGE BED

Comfortable massage bed, with face hole and removable pillow. Ideal for physical therapy and wellness centres. Adjustable back rest 0 to 45 degree
Supplied with couch roll holder.

Product size: 183x61x75 cm
Packing size: 188x17x66 cm
Net/Gross weight: 28/31 kg
Maximum load: 175 kg

FOLDABLE MASSAGE CHAIR

- 44050 FOLDABLE MASSAGE CHAIR

Comfortable foldable massage chair ideal for physical therapy and wellness centres. Made in PVC vinyl with 5-6 cm foam thickness
Metal frame
Packing size: 106x27xh 50 cm
Net/Gross weight: 7/13 kg
Maximum working load: 160 kg



Folded massage chair



WING SCREEN WITH TREVIRA CURTAINS



SCREEN WITH TREVIRA CURTAINS

Build up the screen you need choosing among 4 frames and 6 colours of Trevira curtains.

Wing screen

Aluminium alloy tubular frame mounted on feet or castors (Ø 50 mm).

Size: 150xh 170 cm (3 wings) or 200xh 170 cm (4 wings)

Trevira curtains are flame-proof (Class I), antiallergic, avoid bacterial growth, waterproof and highly resistant to abrasion.

Thick weft to avoid dust infiltration and improve privacy, washable up to 60°C.

Available in 6 colours to match any need. Custom-made curtains available on request.

Made in Italy.

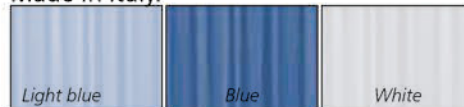

| code | WING SCREEN FRAME without curtain |
|-------|-----------------------------------|
| 45560 | 3 wing screen |
| 45561 | 3 wing screen with castors |
| 45562 | 4 wing screen |
| 45563 | 4 wing screen with castors |

| code | CURTAINS* IN TREVIRA 45xh 132 cm |
|-------|----------------------------------|
| 45570 | Curtains - light blue |
| 45571 | Curtains - blue |
| 45572 | Curtains - white |
| 45573 | Curtains - beige |
| 45574 | Curtains - green |
| 45575 | Curtains - peach |



*you have to buy 3 or 4 curtains depending on frame you choose



3 OR 4 WINGS SCREEN WITH PLASTIC CURTAINS



Made in Italy

27970



27974

- 27970 3 WINGS SCREEN
 - 27971 3 WINGS SCREEN with castors
 - 27972 4 WINGS SCREEN
 - 27974 4 WINGS SCREEN with castors
- Aluminium alloy tubular frame.
Weight 5 kg (3 wings), 8 kg (4 wings).
Fire-retardant, foldable washable white plastic curtains mounted on feet or castors (Ø 50 mm).
Size: 150xh 170 cm - 3 wings (50 cm each)
200xh 170 cm - 4 wings (50 cm each)
Made in Italy.

SEPARATION SYSTEMS AND CURTAINS see page 106

2 OR 3 WINGS WARD SCREENS WITH TREVIRA OR COTTON CURTAINS

Width: 60+60+60 cm

Height: 180 cm

Width: 60+60 cm



45580



45579

- 45578 2 WINGS SCREEN - white cotton cloth
 - 45579 2 WINGS SCREEN - light blue Trevira
 - 45580 3 WINGS SCREEN - white cotton cloth
 - 45581 3 WINGS SCREEN - light blue Trevira
- Exclusive 2 or 3 wings ward screens with sturdy structure in oval tube (30x15 mm), painted with epoxidic powder metal grey.
Light blue Trevira curtains or white washable cotton cloth.
Equipped with 4 adjustable feet that ensure increased stability.
Class I Medical Device complying with European Directive 93/42
Made in Italy.



CABINETS FOR MEDICINES AND INSTRUMENTS - MADE IN ITALY

CABINETS ARE SUPPLIED DISASSEMBLED



27898

Size: 52x35x138 cm
Pack size: 65x26x134 cm
Weight: 31 kg



27899

Size: 75x37x164 cm
Pack size: 72x24x156 cm
Weight: 45 kg



27900

Size: 75x37x164 cm
Pack size: 72x24x156 cm
Weight: 50 kg



27902

Size: 79x36x186 cm
Pack size: 88x36x96 cm
Weight: 56 kg

- 27898 VALUE CABINET - 1 door
- 27899 VALUE CABINET - 2 doors

Cabinets made of enamelled steel sheet with tempered glass doors. Hinged glass door with lock and key. Three stainless steel shelves adjustable in height. Delivered in kit form.

- 27900 VALUE CABINET - 4 doors (hinged)
- 27902 VALUE CABINET - 4 doors (2 hinged, 2 sliding)

Cabinets made of enamelled steel sheet with 2 overlapped compartments. Upper compartment with 2 tempered glass door (hinged door 27900 or sliding door 27902), lock with key and 2 stainless steel, height adjustable shelves. Inferior compartment with 2 doors made of enamelled steel plate and 1 enamelled steel sheet shelf. Delivered in kit form.

CABINETS WITH 1, 2, 4 DOORS AND WALL CABINETS



27901

27905

27903

Lower section with 1 steel shelf



27912

Hanging cabinet with 2 lockable doors. Inside division in 2 compartments left side with 2 removable shelves, right side with 1 removable shelf.



27911

Hanging cabinet to keep medicine with 2 glass tempered doors and 2 tempered glass shelves adjustable on master rack to be hung by two holes on the back

GIMA CABINETS Choice of cabinets with epoxy coated steel structure and tempered glass. Rack-mounted adjustable glass shelves. Rubber feet.

| TECHNICAL SPECIFICATIONS | 27901 | 27905 | 27903 | 27911 | 27912 |
|---------------------------|-------------|-------------|-------------|------------|------------|
| Door: | 1 | 2 | 4 | 2 | 2 |
| Adjustable glass shelves: | 3 | 4 | 3 | 2 | 2 |
| Weight kg: | 30 | 47 | 45 | 16 | 18 |
| Size cm: | 53x36xh 144 | 75x38xh 169 | 75x38xh 169 | 60x30xh 60 | 80x33xh 45 |

- 27901 CABINET - 1 door
 - 27905 CABINET - 2 doors
 - 27903 CABINET - 4 doors
 - 27911 WALL CABINET - glass sliding door
 - 27912 WALL CABINET - painted door
- All cabinets are made in Italy.

DOCTOR CABINET



EN 60598-1
EN 60598-2-4

Metal tubular frame with fixed height 100 cm and flexible arm 38 cm.

27990

• 27990 STUDIO LIGHT
Metal tubular frame with plastic base Ø 60 cm with 5 plastic wheels.

TECHNICAL SPECIFICATIONS

100 Watt lamp (not included)
Power supply: 230 V

| code | Product | Description | Size | Weight |
|-------|-----------------------|--|-----------|--------|
| 27920 | DESK - with 2 drawers | Desk with 2 side drawers with locking top drawer and enamelled tubular steel frame | 120x70x78 | 31 |
| 27403 | EXAMINATION COUCH | Single-hinged examination table with aluminium tubular frame. Comes complete with simulated leather mattress (grey), backrest adjustable through different positions. Delivered in kit form. | 176x60x78 | 22 |
| 27989 | COAT HANGER | Free-standing coat hanger with chromed steel frame with 8 knobs and umbrella holder | | 5 |
| 27990 | LIGHT | Not medical. 100 W. Aluminium tubular frame with 5 spoke base on 50 mm castors. Adjustable height thanks to flexible arm. Lamp not included. | | 3 |

STACKABLE CHAIRS

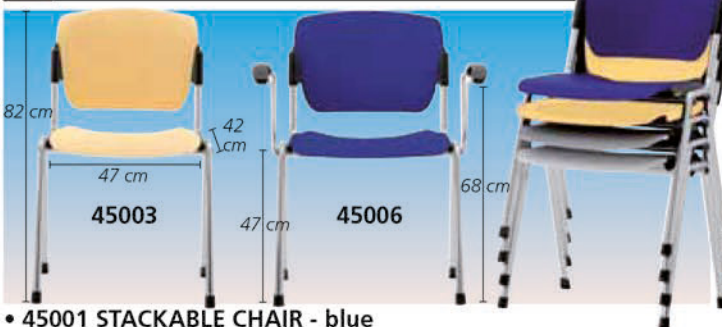

- 45001 STACKABLE CHAIR - blue
- 45002 STACKABLE CHAIR - grey
- 45003 STACKABLE CHAIR - peach
- 45006 STACKABLE CHAIR with arms - blue

Chromed steel frame, self-extinguishing plastic seat. Stackable up to 20 chairs. Weight 5 kg (45001-3), or 6.8 kg (45006). Self-extinguishing Class 1. Made in Italy.

CHAIRS



- 27932 CHAIR padded seat
Stainless steel white painted frame chair with grey padded seat and back. Stackable. Load 120 kg.
- 27933 CHAIR padded seat with armchairs
Same as 27932 but with padded arm-rests. Made in Italy.

S/S WASTE BINS WITH PEDAL

- 27984 WASTE BIN 9.5 l - with pedal - Ø 25xh 35 cm
Made of enamelled steel with plastic inner bucket - weight: 2 kg
- 27985 S/S WASTE BIN 9.5 l - with pedal - Ø 25xh 35 cm
Made of AISI 304 stainless steel with plastic inner bucket - weight: 2 kg
- 27986 S/S WASTE BIN 12 l with pedal - Ø 32xh 36 cm
Made of stainless steel AISI 430. Metal handle for easy emptying. Removable inner plastic bucket. Made in Italy.
- 27983 S/S WASTE BIN 70 l with pedal - Ø 42xh 72 cm
Made of stainless steel. Non-slip rubber pedal. Two lateral handles avoid fingers pinching. Galvanized inner bucket with handle. Made in Italy.



DOCTOR CABINET



| code | Product | Description | code | Product |
|-------|--------------------------------|--|-------|-------------------------------------|
| 27919 | DESK -with 2 drawers | Desk with 2 lockable side drawers with strong structure in oval tube painted with epoxy powder, metal grey. White work top with rubber edge and round corner. Size 130x71xh80 cm | 27616 | KING EXAM. COUCH See page 133 |
| 45581 | WING SCREEN Trevira curtain | 3 wings screen with sturdy structure in oval tube, painted with epoxy powder metal grey. Light blue Trevira curtains. Curtains specifications see page 137 | 30760 | SIMPLEX LIGHT See page 204 |
| 45580 | WING SCREEN | Same as above but with white washable cloth. | 27984 | WASTE BIN See page 139 |
| 27921 | TROLLEY | Structure in oval tube, painted with epoxy powder metal grey. White shelves with PVC edge, guard-rail on 3 sides. Size 50x60xh80 cm | 45211 | STOOL See page 141 |
| 27987 | COAT HANGER | Free standing coat hanger with 5 knobs, epoxy powder grey painted steel structure and umbrella holder. | 45082 | CREMONA CHAIR See page 142 |
| | | | 27979 | FOOT-STOOL - two steps See below |

DESK

• **27919 DESK with 2 drawers**
Desk with 2 lockable side drawers with strong structure in oval tube painted with epossidic powder, metal grey. White work top with rubber edge and round corner.
Size 130x71xh 80 cm
Made in Italy.



TROLLEY

• **27921 TROLLEY**
Structure in oval tube, painted with epossidic powder metal grey. White shelves with PVC edge, side-rail on 3 sides.
Size 50x60xh 80 cm
Maximum load: 30 kg
Made in Italy



FOOT STOOLS - 1 OR 2 STEPS

• **27980 FOOT-STOOL - one step - aluminium**
• **27982 FOOT-STOOL - two steps - painted**
Mounting steps with painted tubular frame and plastic foot board.
Load 90 kg.
Non slipping grey platform 40x20.
Size: 40x51xh 25 (27980),
40x53xh 44 (27982).
Made in Italy.

• **27978 FOOT-STOOL - one step**
• **27979 FOOT-STOOL - two steps**
Structure in oval tube 30x15 painted with epossidic powder. Non slipping black platform.
Size: 45x26xh 20 cm
44x40xh 22/45 cm
Maximum load: 100 kg
Made in Italy.

• **27976 FOOT-STOOL - one step - disassembled**
• **27977 FOOT-STOOL - two steps - disassembled**
Structure made of chrome plated steel tube with rubber feet. Non slipping black plastic platform.
Size: 40xh 24 cm (27976)
40xh 42 cm (27977)
Delivered in kit form.
45x27xh 9 cm (27976)
51x42xh 12 cm (27977)
Made in Italy.



DELIVERED DISASSEMBLED

HEIGHT ADJUSTABLE STOOLS - MADE IN ITALY

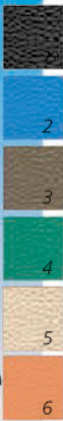

AVAILABLE IN 6 COLORS

- 45200 STOOL 1 - black
 - 45201 STOOL 2 - blue
 - 45202 STOOL 3 - grey
 - 45203 STOOL 4 - green
 - 45204 STOOL 5 - beige
 - 45205 STOOL 6 - apricot
- Padded simulated leather seat
 Ø 30 cm.
 Height adjustable 50 to 60 cm.
 Fire proof.
 Metal base with 5 castors.



Height adjustable 60-86 cm



- 45210 STOOL - black
 - 45211 STOOL - blue
 - 45212 STOOL - white
- Padded simulated leather seat
 Ø 36 cm.
 Height adjustable 50-60 cm
 Plastic base with 5 castors.

- 45220 STOOL - black
 - 45221 STOOL - white
 - 45222 STOOL - red
- Padded fire proof simulated leather seat and back. Height adjustable. Plastic base with 5 castors and chromed ring.



- 27950 STOOL - feet
 - 27951 STOOL - castors
- Stainless steel seat AISI 304 Ø 32 cm.
 Height adjustable 47-59 cm (27950).
 Plastic base. Made in Italy.



- 27948 STOOL - feet
- Stainless steel seat AISI 304 Ø 32 cm. Height adjustable 47-59 cm. Aluminium base with feet. Made in Italy.



- 27952 STOOL - grey
- Washable padded simulated leather seat Ø 31 cm. Height adjustable 50-62 cm. Plastic base with foot. Made in Italy.



- 27953 STOOL - grey
- Washable padded simulated leather seat Ø 31 cm. Height adjustable 54-66 cm. Plastic base with 5 castors. Made in Italy.

HEIGHT ADJUSTABLE STOOLS

ERGONOMIC HEIGHT ADJUST. STOOLS



- 45230 STOOL - black
 - 45231 STOOL - white
 - 45232 STOOL - blue
 - 45233 STOOL - green
 - 45234 STOOL - beige
- Padded simulated leather seat
 Ø 33 cm.
 Height adjustable 53 to 68 cm
 • 45228 CASTORS - spare

- 45240 STOOL - black
 - 45241 STOOL - white
 - 45242 STOOL - blue
 - 45243 STOOL - green
 - 45244 STOOL - beige
- Padded simulated leather seat
 Ø 33 cm with backrest.
 Height adjustable 53 to 68 cm
 • 45228 CASTORS - spare



- 45250 ERGO STOOL - black
 - 45251 ERGO STOOL - white
 - 45252 ERGO STOOL - blue
- Ergonomically designed comfortable stool with saddle-shaped seat and height adjustment with a gas piston.
 Height adjustable 52 to 67 cm
 • 45228 CASTORS - spare



3 adjustments:
 Backrest angle
 Seat angle
 Adjustment of height

- 45260 ERGO B STOOL - black
 - 45261 ERGO B STOOL - white
 - 45262 ERGO B STOOL - blue
- Ergonomically designed comfortable stool with saddle-shaped seat. Three levers with a gas piston allow adjustment of height, backrest angle and seat.
 Height adjustable 62 to 78 cm
 • 45228 CASTORS - spare



OFFICE CHAIRS WITH OR WITHOUT ARMREST - MADE IN ITALY



- 45071
- 45070
- 45065
- 45075
- 45060
- 45076

45075

Functional office upholstered chair, with armrests and polypropylene swivel base, movable backrest with permanent contact.

CUNEO CHAIR without armrest

| | Red | Grey | Black | Blue | Any colour* |
|-------------|-----|------|-------|-------|-------------|
| Fabric | - | - | - | 45060 | 45063 |
| Leatherette | - | - | 45065 | - | 45069 |

CUNEO CHAIR with armrest

| | | | | | |
|-------------|-------|-------|-------|-------|-------|
| Fabric | 45070 | 45071 | - | - | 45073 |
| Leatherette | - | - | 45075 | 45076 | 45079 |

Available in 30 days. Minimum order 12 pieces. Select colour on www.gimality.com and indicate with order

| Weight | Backrest height | Seat height | Width | Depth |
|--------|-----------------|-------------|-------|-------|
| 12 kg | 98/111 cm | 42/52 cm | 56 cm | 49 cm |



- 45081
- 45082
- 45083

45082

Superior quality chair with neat lines, upholstered seat and backrest for greater comfort, swivel base, armrests, permanent contact movement of the backrest.

High density foam.

UNI EN 1335/1/2/3. Maximum load: 110 kg.

CREMONA CHAIR with armrest

| | Red | Grey | Blue |
|--------|-------|-------|-------|
| Fabric | 45083 | 45081 | 45082 |

| Weight | Backrest height | Seat height | Width | Depth |
|--------|-----------------|-------------|-------|-------|
| 12 kg | 90/107 cm | 45/52 cm | 58 cm | 44 cm |



- 45091
- 45095
- 45092
- 45096

45091

Quality chair with upholstered seat and backrest, permanent contact movement of backrest and swivel base. Maximum load: 110 kg. UNI EN 1335/1/2/3.

VARESE CHAIR without armrest

| | Red | Blue |
|--------|-------|-------|
| Fabric | 45091 | 45092 |

| | Red | Blue |
|--------|-------|-------|
| Fabric | 45095 | 45096 |

| Weight | Backrest height | Seat height | Width | Depth |
|---------|-----------------|-------------|-------|-------|
| 11.6 kg | 94/112 cm | 46/59 cm | 60 cm | 47 cm |

VISITOR CHAIRS



- 45030
- 45032
- 45036
- 45035

45030

- 45030 ISO - fabric - red
- 45032 ISO - fabric - blue
- 45035 ISO - leatherette - black
- 45036 ISO - leatherette - blue

Comfortable upholstered chair with 4 legged frame. Can be used for patient and waiting rooms, with Cuneo, Cremona and Varese chairs. Comfortable seat made of expanded polyurethane hit injected heliocell foams. Maximum load: 110 kg.

| Weight | Backrest height | Seat height | Width | Depth |
|--------|-----------------|-------------|-------|-------|
| 7 kg | 82 cm | 45 cm | 53 cm | 43 cm |

EXECUTIVE CHAIRS



- 45122
- 45120
- 45122

45120

- 45120 SALISBURGO executive swivel chair - leather - black
- 45122 SALISBURGO visitor cantilever chair - leather - black

High and low back stylish executive chairs. Refined lines and maximum comfort. 2 positions tilting movement, swivel base, polypropylene armrests, height adjustable by gas pump. Maximum load: 110 kg.

| GIMA code | Weight | Backrest height | Seat height | Width | Depth |
|-----------|--------|-----------------|-------------|-------|-------|
| 45120 | 17 kg | 118/128 cm | 43/53 cm | 62 cm | 55 cm |
| 45122 | 14 kg | 95 cm | 45 cm | 62 cm | 55 cm |



45128

Maximum load: 110 kg

ELITE EXECUTIVE CHAIR
Executive low-backed or high-backed armchair. Fabric or leatherette. Steel and chrome plated base and arms. Height adjustable by gas pump.

ELITE low-backed chair - 83-93 cm

| | Red | Black | Beige | Any colour* |
|-------------|-------|-------|-------|-------------|
| Fabric | 45124 | - | - | 45126 |
| Leatherette | - | 45127 | 45128 | 45132 |

ELITE PLUS high-backed chair - 101-111 cm

| | | | | |
|-------------|---|-------|---|-------|
| Leatherette | - | 45136 | - | 45140 |
|-------------|---|-------|---|-------|

*Available in 30 days. Minimum order 4 pieces. Select colour on www.gimality.com and indicate with order

| Weight | Backrest height* | Seat height | Width | Depth |
|---------|------------------|-------------|-------|-------|
| 14.5 kg | 83/93 cm | 39/49 cm | 51 cm | 45 cm |

*Low-backed chair

X-RAY ILLUMINATORS - LIGHT BOXES

X-RAY ILLUMINATORS

GIMA light boxes are designed according to clinical standards for an extra white light for an accurate and precise reading of any detail. They incorporate a 3 mm acrylic screen compliant with safety norms (fuses, Schuko plug, green light On/Off, ...). Can be used on the table placed horizontally or vertically, depending on model or wall mounted.

Body made of oven-fired epoxy powder coated aluminium and injected ABS (colour RAL 7035).

TECHNICAL SPECIFICATIONS

Colour temperature: Cool white 6,500 °K
 Power supply: 230 V - 50 Hz (60 Hz available with surcharge)
 Protection fuse: 2x1A
 Bipolar light switch
 Schuko plug with 2 m cable
 All components UL, DVE, IMQ approved
 Made in Italy



| code | X-RAY ILLUMINATORS - LIGHT BOXES | External dimensions (cm) | | | | Types |
|-------|----------------------------------|--------------------------|--------|-------|--------|-------------------|
| | | Length | Height | Depth | Weight | |
| 27364 | Light box 38x38 cm | 43 | 43 | 12 | 6 | 1 panel |
| 27365 | Light box 38x62 cm | 67 | 43 | 12 | 8 | 1,5 panel |
| 27366 | Light box 38x92 cm | 97 | 43 | 12 | 11 | 2 panels |
| 27367 | Light box 38x122 cm | 127 | 43 | 12 | 14 | 3 panels |
| 27368 | Light box 38x153 cm | 158 | 43 | 12 | 18 | 4 panels |
| 27369 | Light box 76x122 cm | 127 | 2x43 | 12 | 28 | 2x3 panels |
| 27370 | Light box 76x153 cm | 158 | 2x43 | 12 | 36 | 2x4 panels |
| 27372 | Light box 92x38 cm | 43 | 97 | 12 | 11 | 2 panels vertical |
| 27373 | Light box 122x38 cm | 43 | 127 | 12 | 14 | 3 panels vertical |
| 27378 | Neon tube for 27364 | | | | | |
| 27379 | Neon tube for 27366, 27372 | | | | | |

VALUE FOR MONEY LIGHT BOXES

GIMA X-ray illuminators have been designed according to clinical recommendations for an extra white light to give an accurate and precise reading of any detail. Manufactured with metacrylate screen, and according to safety norms (fuses, Schuko plug, green light on/off, ...). The unique film gripping system gives full use of viewing area. White colour.

Made in Italy.

AVAILABLE ALSO WITH ADJUSTABLE LIGHT

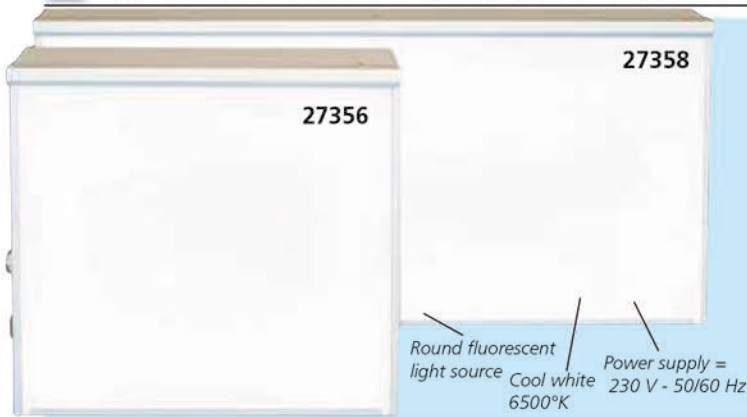

| code | X-RAY ILLUMINATORS - LIGHT BOXES | External dimensions (cm) | | | | Types |
|-------|----------------------------------|--------------------------|--------|-------|--------|----------|
| | | Length | Height | Depth | Weight | |
| 27356 | 36.5x40 cm | 38.5 | 43.5 | 11 | 5.4 | 1 panel |
| 27357 | 36.5x40 cm - adjustable | 38.5 | 43.5 | 11 | 5.4 | 1 panel |
| 27358 | 75x40 cm | 77 | 43.5 | 11 | 11 | 2 panels |
| 27359 | Round fluorescent light - spare | | | | | |

ILLUMINATED AND NOT ILLUMINATED OPTOMETRIC CHARTS



GIMA luminous optotypes have been designed according to clinical recommendations for an extra white light to give an accurate and precise reading of any detail. Manufactured with acrylic screen, and according to safety norms (fuses, Schuko plug, green light On/Off,...)

| OPTOMETRIC CHARTS | Illuminated GIMA code | Not illuminated GIMA code |
|--------------------|-----------------------|---------------------------|
| Armagnac - 5 m | 27380 | 27390 |
| Monoyer - 3 m | 27381 | 27391 |
| Mixed decimal - 3m | 27382 | 27392 |
| Children - 3 m | 27383 | 27393 |
| Animals - 5 m | 27384 | - |
| Spare Tube 700 | 27388 | - |

TECHNICAL SPECIFICATIONS

Viewing Area: 24 x 62 cm 24 x 61 cm
 External dimensions: 29.5x67.5x12 cm 29 x 66 x 2.5 cm
 Weight: 6 kg 2 kg
 Power supply: 230 V - 50 Hz (60 Hz on request) only 27380-4
 Made in Italy
 Other specifications like x-ray illuminators 27364-72



- MONOYER**
3m
• 27381
- MIXED DECIMAL**
3m
• 27382
- ARMAGNAC**
5m
• 27380
- CHILDREN**
3m
• 27383
- ANIMALS**
5.5m
• 27384

See economic optometric charts at page 227.

LED ULTRA SLIM X-RAY ILLUMINATORS - DESKTOP AND WALL

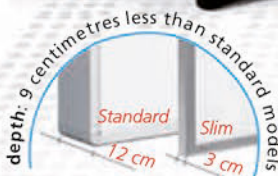
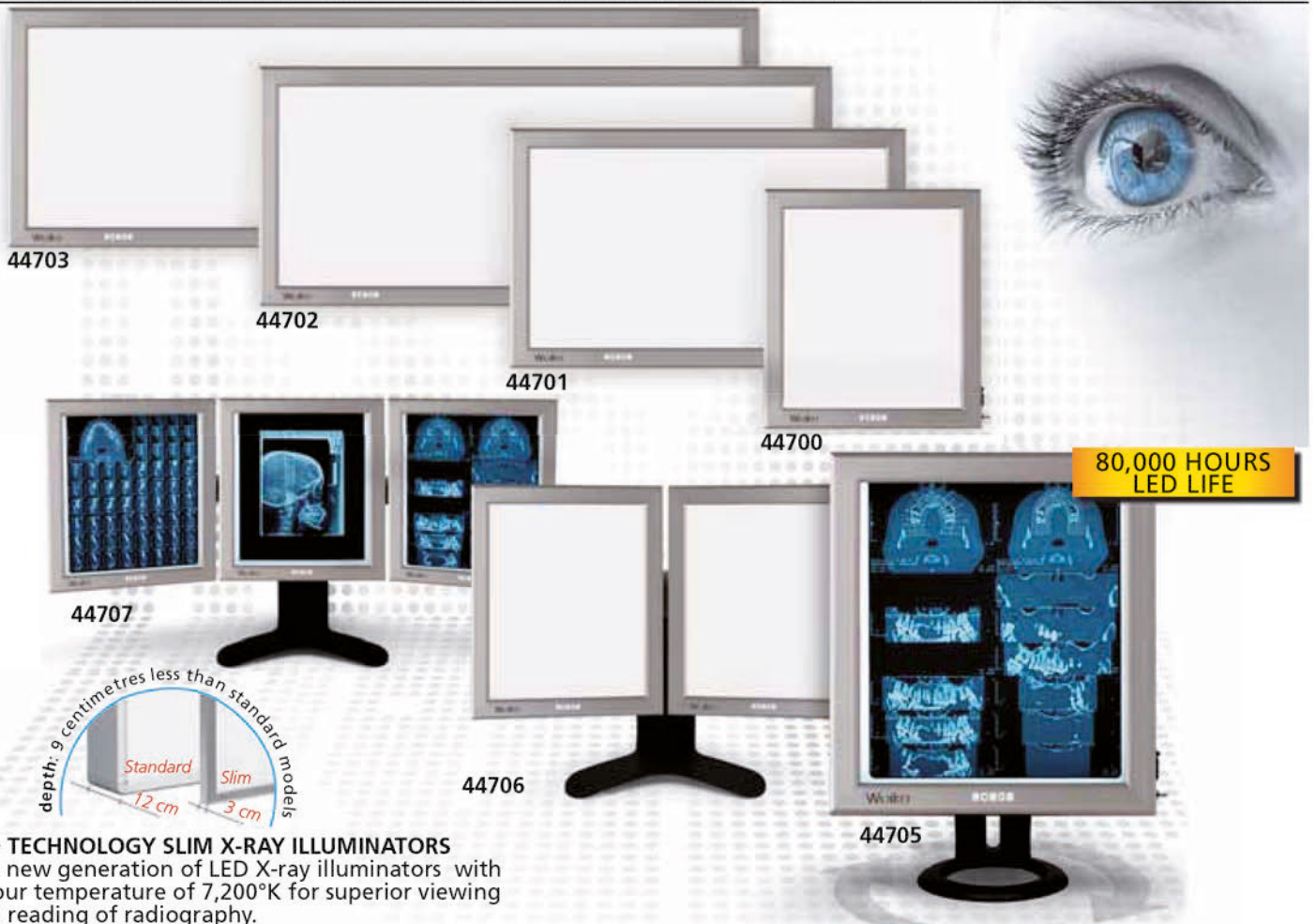

LED TECHNOLOGY SLIM X-RAY ILLUMINATORS

The new generation of LED X-ray illuminators with colour temperature of 7,200°K for superior viewing and reading of radiography. Complete elimination of light flickering and 3,500 cd/mq luminance for more uniform light diffusion. Frame in antiscratch anodized aluminium. Film gripping system incorporated. Dimmer for luminance adjustment from 30% to 100%. - FAS: automatic switching on/off at the positioning/removal of the film.

Economic advantages:
 - LED life 80,000 hours, with low maintenance costs
 - low energy consumption compliant with European law
 Double support for horizontal or vertical wall mounting or desktop.

Fully adjustable desktop model:

- Position of panel can be totally adjusted:
- height adjustment 13 cm
 - inclination 35° (+25°/-5°)
 - vertical or horizontal positioning (44705 only)
 - horizontal rotation 10° (270° for 44705 only)

| code | WALL LED SLIM VIEWERS viewing area | External size - cm | | | Weight kg | Switches | Types |
|-------|------------------------------------|--------------------|--------|-------|-----------|----------|----------|
| | | Length | Height | Depth | | | |
| 44700 | Light box 42x36 cm | 46 | 50.5 | 3 | 4 | 1 | 1 panel |
| 44701 | Light box 42x72 cm | 82 | 50.5 | 3 | 8 | 1 | 2 panels |
| 44702 | Light box 42x108 cm | 118 | 50.5 | 3 | 12 | 1 | 3 panels |
| 44703 | Light box 42x144 cm | 154 | 50.5 | 3 | 16 | 1 | 4 panels |

| code | DESKTOP LED SLIM VIEWERS viewing area | External size - cm | | | Weight kg | Switches | Types |
|-------|---------------------------------------|--------------------|--------|-------|-----------|----------|----------|
| | | Length | Height | Depth | | | |
| 44705 | Light box 42x36 cm x1 | 46x1 | 50.5 | 3 | 6 | 1 | 1 panel |
| 44706 | Light box 42x36 cm x2 | 46x2 | 50.5 | 3 | 20 | 2 | 2 panels |
| 44707 | Light box 42x36 cm x3 | 46x3 | 50.5 | 3 | 26 | 3 | 3 panels |

TECHNICAL SPECIFICATIONS

Colour temperature: Cool white 7,200°K
 Power supply: 110-230 V - 50/60 Hz
 Conformity to Low Voltage Directive 2006/95/CE
 Conformity to Electro Magnetic compatibility 2004/108/CE
 Conformity to EEC directive 2007/47 medical Device Class I
 All components UL, DVE, IMQ approved

Brightness: 3,500 cd/m²
 LED life: 80,000 hours

Made in Italy

PANELS ADJUSTMENT

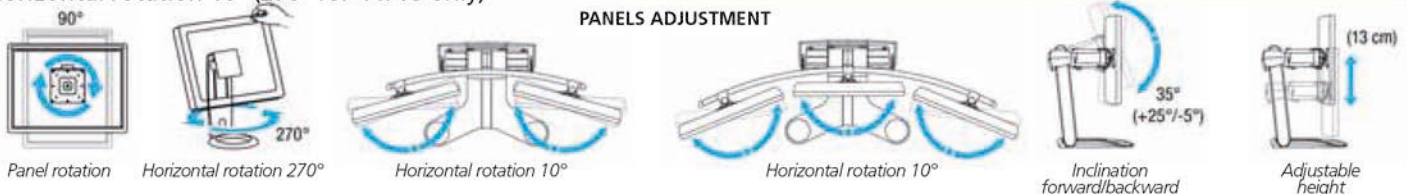

LED ULTRA SLIM OPTOMETRIC CHARTS

LED ULTRA SLIM OPTOMETRIC CHARTS

New generation of optometric charts with same specifications as above X-ray illuminators. Made in Italy.

| code | LED ULTRA SLIM OPTOMETRIC CHARTS - WALL | | |
|-------|---|---------------|------------|
| | Viewing area | External size | |
| 44710 | Armagnac - 5 m | 25.5x63 cm | 34x72x4 cm |
| 44711 | Monoyer - 3 m | 25.5x63 cm | 34x72x4 cm |
| 44712 | Mixed decimal - 3m | 25.5x63 cm | 34x72x4 cm |
| 44713 | Children - 3 m | 25.5x63 cm | 34x72x4 cm |

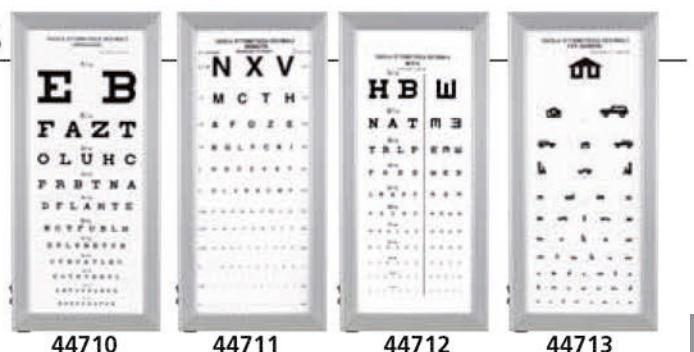



OFICINA CENTRAL

Calle de Joaquín Turina, 2
1ª planta, Oficina 6
28224. Pozuelo de Alarcón
Madrid, España
T +34 917 342 058
F +34 917 903 734
lomisa@lomisa.com



www.lomisa.es

Nos reservamos el derecho a cambiar las especificaciones técnicas sin previo aviso