



- IHEALTH WIRELESS HEALTH-CARE PRODUCTS 
- DIAGNOSTIC TESTS LABORATORY 
- OPERATOR'S PROTECTION 
- HOLLOWARE - SURGICAL INSTRUMENTS - SYRINGES 
- MEDICAL BAGS 
- SCALES & MEASURES 
- HEALTH CARE PATIENT AIDS 
- FURNITURE 
- PHYSIOTHERAPY NEBULIZERS - SUCTION PUMPS 
- GYNAECOLOGY & PROCTOLOGY 
- CAUTERY & ELECTROSURGERY 
- LOUPES, VISION & ENDOSCOPY 
- MEDICAL LIGHTS 
- DIAGNOSTICS 
- AUDIOMETRY & RESPIRATORY 
- ECG MONITORS & ULTRASOUND 
- FIRST AID PARAMEDICAL - EMERGENCY 
- STERILIZATION 
- VETERINARY 
- HUMAN ANATOMY MODELS 





En **LOMISA** nos centramos en los proyectos con la finalidad de mejorar la eficiencia operativa de un centro de salud. Hacemos frente, junto a nuestros clientes, al reto de modernizar sus instalaciones y servicios, proporcionando tecnologías vanguardistas, procedimientos probados y protocolos clínicos actualizados.

Nuestra visión a largo plazo siempre mejora la calidad de vida de los pacientes, que deberían beneficiarse del uso de las instalaciones y servicios. Mediante una estrecha colaboración con los profesionales y gestores del sector sanitario, proporcionamos planes, proyectos ejecutables y soluciones materiales para alcanzar los objetivos de sus instituciones públicas o privadas.

Al trabajar a nivel de gobiernos o administraciones centrales, también consideramos la oportunidad de reforzar el funcionamiento de la atención primaria para facilitar o ampliar el acceso de la población a los estándares apropiados de cuidado preventivo, diagnóstico y crítico. Nuestra estrategia para lograr esos objetivos es la potenciación de los actores claves, para que hagan lo correcto.

Nuestro equipo incluye a gestores e ingenieros con una gran experiencia en el sector hospitalario, ampliamente cualificados en el uso de la tecnología médica y la gestión de los servicios clínicos, que reciben el apoyo de una extensa red internacional de asesores clínicos de primer nivel para cubrir cualquier especialidad, desde los servicios clínicos centrales del hospital a las terapias modernas y complejas.

En **LOMISA** proporcionamos una amplia gama de servicios (instalación, ajuste, puesta en marcha, formación técnica y al usuario, mantenimiento preventivo y correctivo durante el periodo de garantía o el ciclo de vida útil) al presupuestar todas nuestras soluciones de equipamiento, como parte de nuestro fuerte compromiso con el cliente.

Otros equipamientos que suministramos:

- Anatomía patológica
- Esterilización y desinfección
- Rehabilitación
- Imagenología
- Laboratorio
- Medicina deportiva
- Oncología
- Quirófanos
- Refrigeración



NUESTRAS MARCAS



OVER 1800 NEW PRODUCTS!

iHEALTH EDGE ACTIVITY TRACKER



page 1

ABBOTT GLUCOSE STRIPS



page 5

GIMA URINE ANALYZER



page 9

COTTON-POLYESTER COATS, JACKETS, TROUSERS



page 23

NURSE WATCHES



page 26

STAINLESS STEEL STERILE INSTRUMENTS



page 37

ETHICON SUTURES



page 40

FOLEY SILICONE CATHETERS

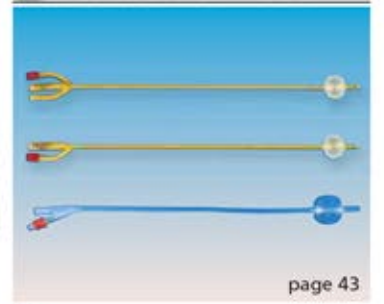

page 43

URINE CONTAINERS



page 45

BD SYRINGES



page 52

MESO-RELLE MESOTHERAPY



page 53

PVC COATED EMERGENCY BAGS



page 61

BODY COMPOSITION MONITOR



page 67

BACKLIGHT DIGITAL THERMOMETERS



page 78

PILL BOX 7-DAYS EASY PLANNER



page 82

ANTI-EMBOLISM ELASTIC STOCKINGS



page 86

SOFFISOF INCONTINENCE PADS



page 86

SHOWER COMMODE WHEELCHAIR



page 87

ANTI-DECUBITUS MATTRESSES STAGE I TO IV

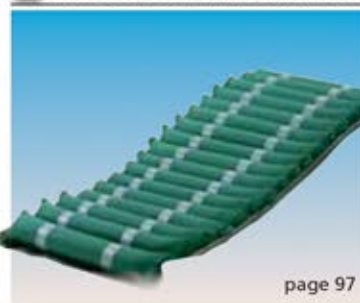

page 97

ADJUSTABLE HEIGHT PATIENT TROLLEY



page 108

BAG HOLDER TROLLEYS



page 115

FOLDABLE MASSAGE TABLES



page 136

I-TECH LASER THERAPY



page 146

PHYSIOTHERAPY PRODUCTS



page 153

OVER 1800 NEW PRODUCTS!

MESH NEBULIZER



page 156

EVO BATTERY ASPIRATOR



page 161

SONOLINE C COLOUR SCREEN DOPPLER



page 172

GIMALED 160,000 LUX



page 200

WI-FI VIDEOSCOPE AND DERMATOSCOPE



pages 206-208

ERKA FINESSE STETHOSCOPES



page 234

LITTMANN CARDIOLOGY IV



page 237

OMRON M7 INTELLI IT



page 253

FILTERS FOR SPIROMETERS



page 261

BREATHCARE PAP AND C-PAP



page 268

BLUE SENSOR ECG ELECTRODES



page 278

COMPATIBLE VIDEO PRINTER PAPER



page 280

MINDRAY Z5 COLOUR ULTRASOUND



page 284

MULTIPARAMETER PATIENT MONITOR



page 289

CAPNOGRAPH AND OXIMETER



page 296

OXYGEN CONCENTRATOR 3I



page 319

SILICONE RESUSCITATOR BAG KIT



page 322

FO. SINGLE PATIENT BLADES



page 330

KINESIOLOGY TAPES



page 336

BSN BANDAGES



page 339

3M ELASTIC STERI-STRIP™



page 345

B-BRAUN IRRIGATION SOLUTIONS



page 349

CHLORHEXIDINE SCRUB KIT



page 350

STERILIZATION TESTS



page 364

iHEALTH WIRELESS HEALTH-CARE PRODUCTS	1-4	CAUTERY & ELECTROSURGERY	181-193
DIAGNOSTIC TESTS-LABORATORY	5-14	LOUPES, VISION & ENDOSCOPY	194-198
OPERATOR'S PROTECTION	15-25	MEDICAL LIGHTS	199-206
HOLLOWARE - SURGICAL INSTRUMENTS - SYRINGES	26-56	DIAGNOSTICS	207-256
MEDICAL BAGS	57-63	AUDIOMETRY & RESPIRATORY	257-268
SCALES & MEASURES	64-74	ECG, MONITORS & ULTRASOUND	269-294
HEALTH CARE - PATIENT AIDS	75-99	FIRST AID - PARAMEDICAL - EMERGENCY	295-347
FURNITURE	100-144	STERILIZATION	348-364
PHYSIOTHERAPY - NEBULIZERS - SUCTION PUMPS	145-166	VETERINARY	365-370
GYNAECOLOGY & PROCTOLOGY	167-180	HUMAN ANATOMY - MODELS	371-376

A	ABBOT glucose strips	5
	ABPM monitors	4, 256
	Activity trackers	1
	Aerosols - nebulizers and accessories	155-158, 263
	Aids for daily living	83
	Air compression therapy	145
	Airways, Guedel	323, 335
	Alcohol testers	14
	AMBU collars, manikins, resuscitators, ...	307, 312, 321, 323, 325
	blue sensors	278
	Amniocentesis needles	172
	Amnioscope	174
	Anatomy models	371-376
	Ano - Procto - Rectoscopes	174
	Anti-Decubitus mattresses, cushions	97-99
	Armchairs	100
	Aspirators - suction pumps	III, 159-166
	Audiometers and booths	257-260
	Autoclaves	357-360
	Ayre Spatulae	177

B	Backrest	102
	Bag holder trolleys	115
	Bags - leather, leatherette, cordura	57-63
	Bandages	80, 336-340
	Bariatric bed	109
	Bathroom aids	87-88, 93
	Batteries	219
	BD: needles, syringes, IV catheters, waste containers	52-55
	Bed pads	86
	Bed pans - plastic, stainless steel	45, 50
	Beds	103-104, 109
	Bedside tables	103-104
	Bibs	22, 84
	Bins	139
	Biopsy Punches	42
	Bipolar forceps, cables	189-190
	Blades - laryngoscope	326-330
	Blades - scalpel	I, 41
	Blankets	347
	Blood pressure monitors	2, 249-255
	Body bags	314
	Body fat analyzers	II, 67-68
	Bone densitometer	168
	Bracelet I.D.	173
	Breast Pump	159
	Brushes - cleaning	350
	Brushes - gynaecology	177
	BSN: tapes, bandages	336-340, 344
	Bulbs - nebulizers	155
	Bulbs - oto/ophthalmo/laryngoscopes	210
	Burn care products	347

C	Cabinets	112, 118, 129, 138-140
	Cameras	194
	Canes	89-90
	Capillaroscope	206
	Capnography	296
	Caps	22, 24
	Cardiac marker test	12
	Cardiolab cardiovascular monitor	4
	Cardiotocograph	169-170
	Carts	111, 113-124 192
	Catheters	43, 53
	Cautery	192
	Centrifuges	9-10
	Chairs	87, 125-130, 139, 142, 318
	Cholesterol monitor and strips	6-7
	Cleaning solutions	84, 348-352

	Clippers	42,80
	Clogs	24-25
	Clothes (coats, trousers)	21, 23-24
	Cohesive bandages	238
	Collars	311-312
	Collectors, biological	45
	Colposcope, Videocolposcope	167-168
	Commode	87, 93
	Condoms	80
	Cot	314
	Cotton wool, rolls, gauzes	341-342
	Couches	II, 131-136
	Couches rolls	134
	Covers for mattress	102
	Cpap devices	268
	CPR mask	335
	Cradle	105
	Crutches	90
	Cryotherapy	193
	Cuffs-sphygmomanometers	243-244
	Curettes Berkeley-Karman	178
	Curettes - dermal	42
	Curettes - ear	222
	Curtains	106, 137
	Cushions	99
	Cutters	29, 35
	Cylinders	320
	Cytology spray and accessories	178

D	Defibrillators and pads	301-308
	Dental Hygiene	79-80
	Dental instruments	36
	Dermatoscope	206-207
	Desk - doctor	139-140
	Diagnostic sets	212-218
	Diagnostic tests	5-14
	Diathermy and accessories	181-192
	Dining table	100
	Disinfection - germicide	348-352
	Distiller - water	360
	Donor chairs	127
	Dopplers: - foetal	171-172
	- vascular	282
	Drapes	27
	Dressing - bandages	80, 343-346
	Dressing kits	33, 38
	Drugs cabinets and trolleys	117-118
	Drug tests	13-14
	Drums	48
	Dynamometer	64

E	Ear curettes, ear speculum	219-220, 222
	Ear irrigation system	221-222
	Ear plugs	80
	ECG - and accessories	269-279
	Ecographs, Ecocolour Doppler	283-287
	EEG paste	281
	Electrodepilator and accessories	184, 187-188
	Electrodes for ECG	277-278
	Electrodes for electrosurgery	185, 187
	Electrosurgery units and accessories	181-192
	Electrotherapy units	147-148
	Emergency bags, rucksacks, cases, kits	61-63, 331-334
	Endometrial cannulas	178
	Endoscopy	194
	Endotracheal tubes	324
	ENT chairs and cabinets	128
	ENT head mirrors	196
	ENT illumination	222-223
	ENT stainless steel instruments	34

ERKA stethoscopes, sphygmomanometers	234, 244, 246, 249		
ETHICON sutures	40		
Exercise bands, tubings, mats	153-154		
Extraction kits	314		
Eye wash system	333		
F			
Face masks	17-18		
Faeces containers	45		
Feeding tubes	43		
Fibre optics - cables/adaptors	195		
Files	35		
Filters: aspirators, spirometers	161-166, 261		
Finger cots	20		
Fingerguard	54		
Fire blankets	347		
First Aid Cases/Bags/Rucksacs	58-63		
Flowmeters	320		
Foetal monitors	169-170		
Foley catheters	43		
Foot stools	140		
Forceps - instruments	26,29,31-34,36-38,173-174		
Forceps - electrosurgery	190-191		
G			
Gag	84		
Gallipots	46,49		
Gauze, gauze pads	80, 341-342		
Gel: antibacterial	348		
Gel: lubricant	43, 176		
Gel: ultrasound, ECG, cosmetic,	281		
Germicidal ultraviolet light	357		
Gloves: copolymer, cotton, latex, nitrile, vinyl, holder	19-20		
Glucose Monitor and strips	3, 5-7		
Goggles	15-16		
Goniometers	65		
Gowns: non-woven, polythene, cotton	21, 23		
Grab bars	88		
Grasping tools	83		
Grounding pads	189		
Guedel airways	323		
Gynaecological beds/chairs	125-127		
Gynaecology - disposables/tests/sets	173-180		
H			
Hammers	225		
Hand towels	22		
Handles for electrosurgery	188		
Hanger - coats	139-140		
Head immobilizers	316		
Head lights, head loupes, head mirrors	195-198		
Heat: Heating pads, hot-cold gel	84		
Heel protector	99		
Height measures	66		
HEINE dermatoscopes, oto-ophthalmo	207,209, 211, 214, 220		
sphygmomanometer	247		
laryngoscopes	329		
Hemoglobin measures	7-8		
Histofreezer	193		
Holloware plastic/stainless steel/disposable	46, 48-50		
Holter: blood pressure monitoring, ECG	256, 276-278		
Hot air sterilizers	355-356		
Hot water bottles	84		
Humidifier	155		
Hypotermic blanket	347		
Hystero-graphy cups	173		
Hysterometer	178		
I			
Ice pack/spray, bags	84, 347		
iHealth wireless healthcare products	1-4		
Incontinence pads	86		
Infrared therapy lamps	150		
Infusion cuffs	309		
Infusion pumps	310		
Infusion sets	54		
Inhaler	155		
Insect repellent devices	79		
Instruments - stainless steel/tungsten	29-36		
Instruments - sterile	37		
Instruments kits: delivery, dressing, suture	33		
Invalid rings	100		
Ionophoretic generator	150		
Irrigation devices	221-222		
Irrigation solutions	349		
Ishihara test	228		
Isothermic cover	347		
IUKO telescopes, projector	198		
IV catheters	53		
IV stands	105		
J			
Jackets: non-woven, cotton-polyester	20, 23		
K			
KAI: biopsy punches and dermal currettes	42		
Kidney dishes/trays	46, 49-50		
L			
Lactate scout	8		
LAERDAL training manikins	II		
Lamps	150, 199-206		
Lancets	5		
Lang stereotest	228		
Laryngeal masks	325		
Laryngeal mirrors	34		
Laryngoscopes	194, 326-330		
Laser therapy	146		
Laundry trolleys	115		
Lice comb and shampoo	79		
Lifters	101		
Light boxes	143-144		
Lights: examination, magnifying, theatre	199-206		
Light sources	195		
Limb clamps	227		
LITTMANN stethoscopes	235-238		
Loupes - magnifying	196-198		
Lung exercise devices	262		
M			
Magnetotherapy unit	149-150		
Magnifying lights	205		
Manikins-training	II, 307		
Masks - face protection	17-18		
Massage beds and chairs	135-136		
Mat: absorbent, anti slip	18		
Mat: decontamination	352		
Mattress: antidecubitus	97-99		
Mattress, covers, pillows	102, 149		
Mattress: physiotherapy	149, 153		
Mattress - vacuum	314		
Mayo tables	114		
Measuring mat	66		
Medication products	80, 341-346		
Mesotherapy	53		
Micro-hematocrit centrifuge	10		
MICROLIFE B.P. monitors	254		
MICROPORE	344		
Microscopes	193, 206-207		
MINDRAY ECG, ultrasound, pulse oximetry	273, 283-284, 298		
Mirrors ENT	196		
Mirrors larynge	34		
Mitten	84		
Models - teaching	371-376		
Monitor multiparameter and accessories	288-294		
Monofilament	225		
Monopolar forceps, scissors, cables, handles	188, 191		
Mouthpieces - spirometry	261		
Multicare "in" device and strips	6		
N			
Nail: scissors, cutters, files	35, 80		
Napkins	22		
Nasal speculum	223		
Nebulizers and accessories	155-158		
Needle destroyer	54		
Needle holders	29,31,35,37-38		
Needles	51-54		
NONIN: pulse-oximeters	294,300		
Nosepharyngoscope	194		
Nystagmus spectacles, videonystagmoscope	226		
O			
Occluders	227		
Office furniture	137-142		
OMRON: B.P. monitors, scale	II, 67, 69, 245, 253		
Ophthalmoscopes	209-218		
Optical tests	227-228		
Optometric charts	143-144, 227		
Orthopedic products	311-313		
Otosclillo irrigation device	221		
Otosopes and accessories	208-220		
Oximeters	296-300		
Oxygen concentrators	319		
Oxygen cylinders and accessories	320		
P			
Pads for defibrillators	304		
Pap devices	268		
Paper ECG, videoprinter	279-280		
Paper products	22, 134		
Papettes	177		
Pap Test	176		
PARAGON blades and scalpels	41		
Patient trolleys	107-108		
Peak flow meters	262		
Pedal exercisers	92		
Pediatric tables, beds, cradles	105		

Pen-lights	217, 224	Surgical instruments	29-34, 37-41
Percussors	225	SURVILLANCE safety lancets	5
Perforator, membrane	173	Sutures	38-40, 345
Pessaries: rubber, silicone	180	Swabs - cotton	177-341
Physiotherapy	153-154	SWANN-MORTON blades and scalpels	I
Pill cutters/crushers/boxes	81-82	Syringe pumps	310
Pillows	99, 102	Syringes	51-53, 221
Pipettes	46		
Plasters	80, 343-346	T	
Plates for electrosurgery	189	3M stethoscopes	235-238,
Pneumatic tourniquets	309	dressing	337, 342, 344-346
Pocket masks	335	Red Dot electrodes	278
Podiatry instruments and kits	35	electrosurgery pads, staple remover	39,189
Podology	35, 64, 129	Tables - theatre	110-111
Podoscope	64	- treatment	131-136
Posture analyzers	64	Tape dressing	343-344
Pouches for sterilisation	363	Tape height measures	65
Pregnancy tests	179	Tape indicators steam	361, 364
Pressure reducers	320	Tape kinesiology	336
Printers	280	Tecar therapy	146
Probe covers - latex	172	TEGADERM	346
Proctoscopes	174, 176	Tens - nerve stimulator	151-152
PT/INR coagulation monitoring system	7	Test tubes	46
Pulse Oximeters and sensors	III, 1, 294-300	Tests - alcohol, drug	13-14
		Tests - gynaecology	179-180
R		Tests - influenza, StrepA, mononucleosis, D-Dimer, CRP, allergy, microalbumin, helicobacter pylori, prostate, malaria, FOB, colon disease	11-12
Razors	42	Tests - urine	9
Record holders	102	Thermal recording paper	169, 279-280, 302
Rectoscope	174	Thermic pads, bottles, bags, devices	58-60
Refrigerator bags	58-59	Thermo feel	225
Removal kits	38	Thermometers	75-78
Respiratory	261-268	Throat scope - illuminator	223
Resuscitators and accessories	321-324	Toilet aids	88, 93
Retinoscope	212	Tongue depressors	223
Retractors	35	Tonometer Schiotz	228
RIESTER oto-ophthalmo, stethoscopes	213, 216, 233	Torches	224
sphygmomanometers, infusion cuffs	244, 245, 248-249, 309	Tourniquets	56, 309
Rollators	91, 92	Towels	22
Rolls for sterilization	363	Transformer AC/DC	196
		Travel enema	176
S		TRAVELJOHN urine and vomit bag	44
Salpingograph - Schultze	172	Trays ISO format	111
Saw for plaster	340	Treatment couches	135-136
Scales - baby/adult/vet	3, 67-74, 366	Trolleys	101, 107-109, 111-124, 140
Scalpels - disposable or stainless steel	I, 31, 41	Trousers	21, 23-24
Scalps vein	51	Tungsten carbide instruments	29-30
Scissors	26, 30-31, 33-35, 37-38, 80, 191, 335	Tuning Forks	226
Scoliometer	64	Tympanometer and eartips	257-258
Scrubs	350	Two points discriminator	225
Sealings/thermowelders	361-362		
SECA scales, measurers	66, 70-71, 73	U	
Sensors for oximeters	293, 295	Ultrasonic cleaners	353-354
Sharps bins	55-56, 60	Ultrasonic nebulizers	156
Shelving system	112	Ultrasonic therapy units	147-148
Shields protective	16	Ultrasound dopplers	283-286
Shoe covers	22	Ultrasound therapy	147-148
Shower chairs, mattress, trolleys	87, 101	Ultraviolet lamps	206
Sigmoidoscopes F.O.	174	Umbilical clamps	173
Silicone tubes	159	Urine analyser and strips	9-10
Sleep apnea	268	Urine bags	44
Slides	178	Urine containers	45
Skeletons, spinal columns ad skulls	374-376		
Skin staple removers	39	V	
Skinfold calipers	67	Vaccine carrier	58
Skin Markers	40	Ventilators	IV
Smoke evacuator	191	Veterinary equipment and instruments	365-370
Soap	84, 348	Videonystagmoscope	226
Socks	85-86	Videoprinter paper	280
Sonost - ultrasound bone densitometer	168	Videoscope, videodermatoscope, dentalscope	206, 208
SONY: papers, printers	167, 280	Visors	16
Specula - ear - nasal	219-220, 223	Vital signs monitors	288-293
Specula - vaginal	175	Vomit bag	44
Sphygmomanometers and accessories	239-255		
Spirometry - equipment	261-268	X	
Spirometry - paper, mouthpieces, filters, turbines	261	X-ray viewers	143-144
Splinters	79, 333		
Splints - aluminium/air/nylon	313-314	W	
SpO ₂ sensors	293- 295	Walking frames, sticks, crutches	89-91
Sponges	83-84	Wall units	123
Spray for cytology fixation	178	Ward screens	106, 137
Stainless steel instruments/holloware	27-37, 48-50	Wash basin pump	123
STERI STRIP	345	Waste containers	139
Sterilization boxes - containers	47, 351	Watches	26
Sterilization test and tapes	361-362, 364	WC, portable	44
Sterilizers - dry heat	355-356	Wheelchairs	93-96
Stethoscopes and accessories	I, 172, 229-238	Wing screens	137
Sticks	89-90	Wipes	22, 349
Stockings	86	Wood lamps	206
Stools	87, 125, 141	Worktops	124
Strep-A rapid test	11	Woundcare	344-346
Stretchers - emergency	315-318		
Stretchers - hospital	107-109		
Suction pumps and accessories	III, 159-166		
Surgery sets	28, 38		

SWANN-MORTON DISPOSABLE BLADES, SCALPELS AND STITCH CUTTERS

SWANN-MORTON DISPOSABLE BLADES AND SCALPELS
Swann-Morton blades and scalpels are renowned for their exceptional quality, precision, consistency and reliability. Swann-Morton manufactures in the UK using high quality

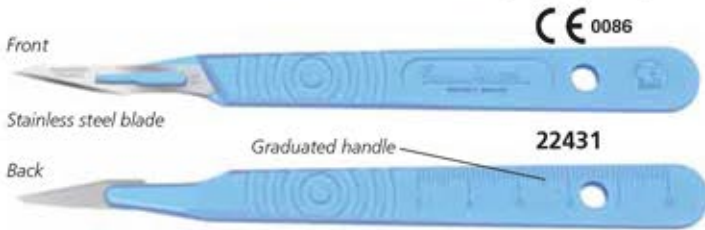

Plastic handle scalpels with stainless steel blades, individually packed in sterilized envelope in box of 10 pcs. Multilanguage box: GB, FR, IT, ES, DE, DK, NL, GR, PT, PL, FI, RU, NO, SE.

code	SWANN-MORTON SCALPELS WITH STAINLESS STEEL BLADE	Minimum order
22430	Disposable scalpels - blade 10 - sterile	box of 10
22431	Disposable scalpels - blade 11 - sterile	box of 10
22432	Disposable scalpels - blade 12 - sterile	box of 10
22433	Disposable scalpels - blade 15 - sterile	box of 10
22435	Disposable scalpels - blade 20 - sterile	box of 10
22436	Disposable scalpels - blade 21 - sterile	box of 10
22437	Disposable scalpels - blade 22 - sterile	box of 10
22438	Disposable scalpels - blade 23 - sterile	box of 10
22439	Disposable scalpels - blade 24 - sterile	box of 10



code	SWANN-MORTON S/S HANDLES	Compatibility
22425	Graduated S/S n° 3 handle	Fits blades 10, 11, 12, 15
22426	Graduated S/S n° 4 handle	Fits blades 20, 21, 22, 23, 24

steel that gives exceptional cutting performance. They operate stringent quality control procedures which ensure unrivalled blade consistency and reliability. This is why Swann-Morton is the preferred choice of many medical professionals worldwide



Carbon steel blades individually packed in metal foil and box of 100.







code	SWANN-MORTON CARBON STEEL BLADES - STERILE - box of 100	Minimum order
22400	Blade 10	 <p>Multilanguage box: GB, FR, IT, ES, DE, DK, NL, GR, PT, PL, FI, RU, NO, SE</p>
22401	Blade 11	
22402	Blade 12	
22403	Blade 15	
22405	Blade 20	
22406	Blade 21	
22407	Blade 22	
22408	Blade 23	
22409	Blade 24	
code	CARBON STEEL STITCH CUTTER BLADE - STERILE	Minimum order
22420	Carbon steel stitch cutter blade	box of 100

COLOURED TRAD STETHOSCOPES



COLOURED TRAD STETHOSCOPES
Coloured aluminium stethoscopes, lightweight and reliable. Chestpiece diaphragm Ø 43.5 mm, bell Ø 30 mm external sizes. Brass binaural. Tubing: length 62 cm, int. Ø 4 mm, ext. Ø 8 mm. Supplied in cardboard box. Manual and box in 11 languages: GB, FR, IT, ES, DE, PT, GR, PL, HU, SE, Arabic.



code	COLOURED TRAD STETHOSCOPES - LATEX FREE	
51000	TRAD single head - black	
51001	TRAD single head - red	
51002	TRAD single head - blue	
51003	TRAD single head - yellow	
51004	TRAD single head - green	
51010	TRAD double head - black	
51011	TRAD double head - red	
51012	TRAD double head - blue	

VALUE EXAMINATION COUCHES



- 44450 VALUE EXAMINATION COUCH - white painted - black
 - 44451 VALUE EXAMINATION COUCH - white painted - white
 - 44455 VALUE EXAMINATION COUCH - chrome - blue
 - 44456 VALUE EXAMINATION COUCH - chrome - beige
- Suitable for medical practices or small surgeries. Easy to assemble. Multilanguage manual (GB, FR, IT, ES). Comes complete with mattress. Top is made with wooden panel and foam rubber and covered

with washable simulated leather Class 1. Two sections: one fixed 130x61xh 5.5 cm and one adjustable (backrest) 50x61xh 5.5 cm. Couch size: 180x61x h 75 cm. Weight 29 kg. Maximum load: 100 kg. Delivered in kit form. Made in Italy.

- 27418 COUCH ROLL HOLDER - optional

STOOLS: see at page 141

LAERDAL LITTLE FAMILY PACK

- 56511 LAERDAL LITTLE FAMILY PACK - 125-01050

All-in-one, realistic and inexpensive quality training. A little family with a focus on quality CPR. The Little Family Pack provides quality CPR training at an affordable price. Designed to reflect the realistic anatomical differences among an adult, a child and an infant. It comes complete with:

- Little Anne Manikin (manikin, training mat, 2 faces, 2 airways, 6 manikin wipes),
- Little Junior Manikin (manikin, training mat, 2 faces, 2 airways, manikin wipes),
- Baby Anne (manikin, training mat, 6 airways, 10 foreign body practice objects) and a large bag on wheels to carry them.
- 56510 LAERDAL LITTLE ANNE - 120-01050



LAERDAL RESUSCI ANNE

- 56520 LAERDAL RESUSCI ANNE FIRST AID FULL BODY - 170-01250
- 56522 LAERDAL RESUSCI ANNE QCPR FULL BODY - 171-01250

The Resusci Anne manikins offer optimal realism for basic adult CPR training. Resusci Anne QCPR allows multiple feed back options that provide opportunity to focus on learner competency:

- measures CPR performance
- assess the results of the performance
- facilitate good feed back to the instructor

Supplied with full body manikin (foam legs), 3 decorated resusci manikin faces, 2 disposable airways, trolley suitcase, kneel mat, jacket, pants, 50 resusci manikin wipes, user guide, Skill guide (only 56522), USB cables (only 56522)



BODY COMPOSITION MONITOR

- 27092 OMRON BF212 BODY COMPOSITION MONITOR
- Measures and displays the following body composition parameters: body weight, body fat (in %) and Body Mass Index (BMI). The 4-sensor technology provides clinically validated body measurements. It measures the body fat percentage by Bioelectrical impedance (Bi).



BODY FAT MONITOR

- 27093 OMRON NBF-306 BODY FAT MONITOR
- Measures body fat percentage, Basal Metabolic Rate (BMR), assessment of body fat percentage and Body Mass Index (BMI) with graphical interpretation of body type. The body fat percentage is measured based on the electric resistance and the personal data. The measured results are displayed approximately 7 seconds after setting data.



OXY 2 PULSE-OXIMETER

• 35072 OXY 2 PULSE OXIMETER

Pulse Oximeter for measuring pulse oxygen saturation and pulse rate through finger. Suitable for domiciliary and professional use in family, hospital, oxygen bar, community healthcare, physical care in sports. It can be used before or after sports, but not recommended throughout.

TECHNICAL SPECIFICATIONS

Display mode: LED display
 SpO₂ measuring range: 0 - 100%, (resolution 1%)
 Accuracy: 70 - 100%: ± 2%, below 70% unspecified
 PR measuring range: 30 - 250 bpm, (resolution 1 bpm)
 Accuracy: ± 2 bpm or ± 2% (select larger)
 Measurement performance in weak filling condition: SpO₂ and pulse rate can be shown correctly when pulse-filling ratio is 0.4%. SpO₂ error is ± 4%, pulse rate error is ± 2 bpm or ± 2% (select larger)
 Power consumption: less than 25 mA
 Voltage: DC 2.6 V - 3.6 V
 Battery working hour: two batteries can work continually for 24 hours
 Safety Type: Interior Battery, BF Type
 Dimension - weight: 60x30.5x32.5 mm - 50 g including two batteries

- SpO₂ value display
- pulse rate value display, bar graph display
- low-voltage indicator
- automatic power off the unit will automatically switch off within 5 seconds if the finger falls out of probe



35072

ASPEED 3.0 PROFESSIONAL SINGLE PUMP ASPIRATOR

• 28279 ASPEED 3.0 ASPIRATOR 15 l/min

Portable, compact reliable aspirator ideal for small surgery. Piston type continuous cycle electric medical device. High vacuum low flow. It requires no maintenance or lubrication. Made in Italy.

STANDARD ACCESSORIES

Autoclavable polycarbonate jar 1,000 cc with safety valve (overflow protection)
 Disposable suction liner 1 l
 99% Antibacterial hydrophobic filter
 Sterile disposable cannula
 Sterile manual flow regulator
 Set of atoxic sterilizable silicone tubes
 Power Cable
 User Manual GB, FR, IT, DE, ES

TECHNICAL SPECIFICATIONS

Operating voltage: 230 V - 50 Hz
 Power consumption: max 140 VA
 Bottle capacity: 1 l
 High vacuum: low flow
 Air flow: 15 l/min
 Adjustable vacuum level: 0 ÷ -0.85 bar (0 ÷ -85 kPa)
 Size: 300x170x160 mm
 Weight: 2.5 kg
 Noise level: 60 dBA
 Operating cycle: continuously
 Class - Type: II - BF



28279

ACCESSORIES AND SPARES FOR ASPEED

code	ACCESSORIES AND SPARES FOR ASPEED
28255	Hydrophobic 99% bacterial filter
28258	Autoclavable jar 1l with cover
28259	Disposable suction liner
25480	Silicone tube 6x12 mm - roll of 30 m
28254	Adaptor to connect catheter to silicone tube

VEGA PLUS PROFESSIONAL SUCTION ASPIRATOR

• 28170 VEGA PLUS SUCTION ASPIRATOR 40 l/min

Professional aspirator for hospital use: tracheotomy, small surgery and post-operative treatments. Silent, high-flow and maintenance-free pump allow long product life and durability. Recommended for nasal aspiration, oral aspiration, tracheal aspiration of body liquids (mucus, catarrh or blood) in adults or children. For use with 1 or 2 jars. Made in Italy.

STANDARD ACCESSORIES

Autoclavable jar (1 l) with overflow valve system
 Antibacterial and hydrophobic filter
 Set of silicone tubes 6x10 mm
 Suction catheter CH20
 Conical connector for probes
 Power cable (Schuko)
 5 languages user manual (GB, FR, IT, DE, ES)



28170 + 28171 + 28226



28170

ACCESSORIES AND SPARES FOR VEGA PLUS

code	ACCESSORIES AND SPARES FOR VEGA PLUS
28229	Hydrophobic, 99% antibacterial filter
28226	121°C autoclavable jar 1 l with cover and overflow system
28227	Cover and overflow valve system for 28226
28185	134°C autoclavable jar 1 l with cover and overflow system
28184	Cover and overflow valve system for 28185
28271	Disposable liner 1 l (cover + bag)
28270	Container for disposable liner 1 l
28171	Holder for second autoclavable jar (28226)
28172	Holder for disposable liner (28271)

TECHNICAL SPECIFICATIONS

Operating voltage: 220-230 V - 50/60 Hz
 Power consumption: max 110 VA
 Bottle capacity: 1 l
 Air flow: 40 l/min
 Max suction: - 0.80 bar
 Size:
 Weight: 3.6 kg
 Operating cycle: continuous
 Class - Type: II - BF

SPENCER 170 AND 190 NXT ELECTRONIC VENTILATORS

- 34006 SPENCER 170 NXT ELECTRONIC VENTILATOR
- 34007 SPENCER 170 NXT KOMPAK ELECTRONIC VENTILATOR
- 34009 SPENCER 190 NXT ELECTRONIC VENTILATOR

Electronic lung ventilators for non invasive ventilation of adult and pediatric patients

- protection against accidental activation of the AIR mix selection lever
- colour coded manometer for easy identification of pressure ranges
- positioning of input and output ports on the side of the device, make connecting and disconnecting easier and offer greater protection to the elements connected to the device
- control knobs on high contrast background for a better identification of the set values
- compact, lightweight aluminium frame

TECHNICAL SPECIFICATIONS	34006-7	34009
Drive:	Electronic	
Frequency:	from 5 to 40 BPM	
Alarms:	High pressure	High pressure Low pressure Apnea
	Pneumatic supply Low battery	Pneumatic supply Low battery
Flow:	2 to 20 l/min	
I/E Ratio:	1:2	
Oxygen concentration:	60% or 100% Patented system	
Trigger:	from -12 to -2 mbar	
Overpressure valve:	20-60 cm H ₂ O - adjustable	
Battery operating time:	Approx. 3 hours	
Manometer scale:	-20 to +80 mbar	
IP protection:	IP24	
Non re-breathing valve:	60 cm H ₂ O	
Pneumatic supply:	from 280 to 600 kPa	
Pneumatic connection:	UNI	
External source:	12 V DC	
	on request AC/DC adapter 100-240 V, 50/60 Hz	
Internal source:	Rechargeable Ni-Mh battery	
Dimensions:	270x177x210 mm	330x177x210
Weight:	3.5 kg	3.6 kg
Structure:	Aluminium, steel, brass, PE	

STANDARD ACCESSORIES

- Patient circuit (corrugated tubing with non re-breathing valve)
- Power cable
- Oxygen tube
- Manual: GB, IT, on request FR, ES, DE, PT
- 2 l oxygen cylinder, pressure reducer, transport case (34007 only)
- Adult face-mask
- Battery
- UNI adaptor

- place and shape of adjustment knobs make the setting of parameters easier in all operative conditions
- constant I/E ratio
- alarms for ventilation monitoring and device management

constant I/E ratio

- alarms for ventilation monitoring and device management

Ventilator 190 NXT also features:

- led bar for breath monitoring
- three ventilation modes (only one for 34006-7)
CMV: mandatory inflation is initiated according to the set parameters
TVM: inflation initiated according to the set parameters only if triggered by the patient
A/CV: inflation is assured to be initiated at intervals determined by the set rate, unless initiated by an earlier patient trigger event.

Made in Italy.

Kompak ventilator with transport case.

Transport case containing ventilator, oxygen cylinder with pressure regulator ready to use.

- 34035 CORRUGATED PVC TUBE - 117 cm
- 34036 PATIENT CIRCUIT (valve+corrugated tube)
- 34037 BATTERY - spare

34006



SPENCER

CE 0123

34009



SPENCER 118 NXT PNEUMATIC LUNG VENTILATOR

- 34016 SPENCER 118 NXT AUTOMATIC VENTILATOR
- 34017 SPENCER 118 NXT KOMPAK AUTOMATIC VENTILATOR

Pneumatic lung ventilator for non-invasive ventilation of adult and pediatric patients. The pneumatic mode of operation allows a significant reduction of maintenance costs associated with the requirements of electrical safety regulations. Total absence of electrical shock risks generated by the device. Protections against accidental activation of power and AIR MIX levers. Colour coded manovacuometer for an immediate display of the pressure in the patient circuit. Lateral positioning of the medical gas input and output, makes the connection and disconnection easier and offers greater protection for the elements connected to the device. Adjustment knobs on high-contrast background allows a better identification of settings. Small, lightweight aluminium body. Positioning and shape of the adjustment knobs facilitate the setting of the ventilation parameters in all operating conditions. The non-constant I/E ratio makes the management of the ventilation more versatile. The presence of one ventilation mode makes it simple and easy to operate. Equipped with alarms required by the EN 794-3 standard.

Class IIb Med. Device according to Dir. 93/42/CEE. Made in Italy.

Kompak ventilator with transport case.
Transport case containing ventilator, oxygen cylinder with pressure regulator ready to use.

- 34035 CORRUGATED PVC TUBE - 117 cm
- 34036 PATIENT CIRCUIT (valve+corrugated tube)

- Patient circuit (corrugated tubing with non re-breathing valve)
- Oxygen tube 100 cm - UNI adaptor
- Pressure reducer (34017 only)



34016

CE 0123

TECHNICAL SPECIFICATIONS

Drive	100% pneumatic
Ventilation mode	Controlled (VC - CMV)
Respiration frequency	10 to 70 breaths/min.
Inspiratory-expiratory phase time I:E	1:2.0 ±0.3 at 10 bpm - 1:1.5 ±0.3 at 70 bpm
Frequency:	10 to 70 bpm
Flow	2 to 20 l/min adjustable
Oxygen concentration	From 60 or 100%
Safety valve	From 20 to 60 mbar
Monovacuometer precision:	1.6
Manovacuometer scale	-20 to +80 mbar
High pressure alarm	60 ±5 mbar
Non-rebreathing valve	Autoclavable, 60 cm H ₂ O
Input connection	UNI
Input pressure	280 to 600 kPa
Dimensions - weight	270x210x177 mm - 3.8 kg
Structure	aluminium, steel, brass, PE

STANDARD ACCESSORIES

- Adult face-mask
- 2 l oxygen cylinder (34017 only)
- Transport case (34017 only)

- Antibacterial filter
- Guedel cannula, tongue holder (34017 only)
- Manual: GB, IT, on request FR, ES, DE, PT

iHEALTH WIRELESS PERSONAL HEALTHCARE PRODUCTS

iHEALTH MYVITALS APP - free

- track data, graphs and history on the iHealth MyVitals App
- multi-patient App (automatically sort measurements data per users)
- free and secure data storage
- share results with your coach and friends or healthcare professional

To manage wireless:

- 1 iHEALTH PULSE OXIMETER
- 2 iHEALTH BODY ACTIVITY TRACKER
- 3 iHEALTH B.P. MONITOR - ARM
- 4 iHEALTH B.P. MONITOR - WRIST
- 5 iHEALTH SCALE
- 6 iHEALTH BODY ANALYSIS SCALE (9 parameters)



iHEALTH products to manage your personal health
iHealth designs innovative, mobile personal healthcare products for everyone. iHealth wireless products with **Bluetooth** connectivity for iPad, iPhone, iPod and Android system, allow to easily measure and track personal data and share instantly with family or doctor.
The powerful **iHealth MyVitals App** will also allow to manage all your health data with custom graphs, statistics, trends. This unique application **tracks the relation between various parameters** such as blood pressure, weight, calorie intake and activities.

App compatible with all Apple and Android platforms. Includes a free iHealth Cloud service.
iHealth MyVitals App available in: GB, FR, IT, ES, DE, NL, GR, HU, PT, RO, RU, TR, JP, KR, CN, AR.
Product package and manual in 8 languages (GB, FR, IT, ES, DE, PT, NL, GR). All products have 2 years warranty.



See the list of compatible devices on ihealthlabs.eu/support

1 iHEALTH AIR PULSE OXIMETER



• 23525 iHEALTH AIR - WIRELESS PULSE OXIMETER

The Pulse Oximeter is a reliable way to spot-check blood oxygen saturation (SpO₂) pulse rate (bpm) and volume of blood flow (perfusion index). This lightweight and portable device takes fast, non invasive measurements at the fingertip.

- measures your blood oxygen saturation and pulse rate from your mobile device
 - records SpO₂ and pulse rate
 - easy-to-read LED screen displays SpO₂, pulse rate and perfusion index
 - connects wirelessly via Bluetooth 4.0 with low energy technology
 - free iHealth app and cloud service include personalized health tools
- Supplied with lanyard and USB charging cable.



TECHNICAL SPECIFICATIONS	
Classification:	Internally powered, type BF
Display System:	LED
Power:	Battery, 3.7 V Li-ion, 300 mAh
SpO ₂ Measuring Range:	70-99%, ±2%
Pulse Rate Measuring Range:	30-250 bpm, ±2 bpm or ±2% larger one
Size:	62x33x28 mm

2 iHEALTH BODY ACTIVITY TRACKER - WRIST/BELT

- 23531 iHEALTH EDGE WIRELESS ACTIVITY AND SLEEP TRACKER
- 23532 iHEALTH WAVE WIRELESS ACTIVITY SWIM AND SLEEP TRACKER

Activity and sleep tracker make it easy to monitor your health. It allows to know your body in motion and at rest and to track your vital signs any time any place.

This innovative device can be worn either as a watch (wrist band) or as a belt-clip (only 23531).

Sweat and rain proof (23531) or waterproof (23532).

iHEALTH activity tracker features:

- track steps, distance, swim, calories burned and monitor sleep
- swimming styles recognition (freestyle, breaststroke...) only 23532
- display swimming laps and time, number of strokes and calories burned (only 23532)
- programmable vibrating alarm function
- display time and date
- automatic on screen reports after running, walking, swimming (only 23532), sleeping
- Bluetooth Sync, easy installation

iHEALTH MyVitals App:

Connects wirelessly via Bluetooth 4.0 technology.



23532

For iOS and Android version 4.4 +
See the list of compatible devices on ihealthlabs.eu/support



Battery: 1x3.7V Li-Ion 100 mAh - 3 years life.
Supplied with 2 wrist bands (23532: blue and black) or 4 wrist bands (23531: black, grey, orange, pink) belt-clips (only 23531) batteries and USB cable for charging.
Manual and box in: GB, FR, IT, ES, DE, PT, NL, GR.

iHEALTH WIRELESS PERSONAL HEALTHCARE PRODUCTS

3 iHEALTH CLEAR SMART ARM B.P. MONITOR - WI-FI

- 23490 iHEALTH CLEAR SMART ARM B.P.M.
- clinically validated blood pressure (ESH)
- universal cuff (22 - 42cm)
- large HD screen which displays results clearly
- stores up to 1,000x2 offline measurements
- automatically save all measurement in your MyVitals app account (Wi-Fi)
- indoor/outdoor temperature to prevent blood pressure variations

TECHNICAL SPECIFICATIONS
 Connectivity: Wifi IEEE802.b/g/n
 Dimensions: 119x118x51 mm
 Cuff circumference: 22-42cm
 Weight: 350g (excluding cuff)
 Measuring method: Oscillometric, with automatic inflation and deflation
 Battery: 1x3.7V Li-ion 2200mAh
 Battery life: 180 measurement on a full charge
 Range: Sys: 60-260mmHg / Dia: 40-199mmHg
 Pulse: 40-180bts/min



3 iHEALTH TRACK CONNECTED ARM BLOOD PRESSURE MONITOR



Dual use: traditional use or use with smartphone



For iOS and Android version 4.4 +
 See the list of compatible devices on ihealthlabs.eu/support

- 23499 iHEALTH TRACK CONNECTED ARM B.P.M.
- clinically validated blood pressure (ESH)
- systolic, diastolic and heart rate (number of beats per minute)
- evaluation of measurements as recommended by the WHO
- detection of arrhythmia
- universal cuff (22-42 cm)
- colour changing display
- easy to use and comfortable
- 60 memories
- one-Click: save all your measurements in your MyVitals App account
- Multilanguage box and manual: GB, FR, IT, ES, DE, GR, PT, NL.
- iHEALTH MyVitals App:**
- track data, graphs and history on the iHealth MyVitals App
- add measurement reminders, free and secure data storage
- share results with friends or healthcare professionals
- 23497 ADULT CUFF - 22-42 cm - spare
- 23498 OBESE CUFF - 30-48 cm



TECHNICAL SPECIFICATIONS
 Connectivity: Bluetooth 4.0
 Size: 98x98x46 mm
 Cuff circumference: 22-42 cm
 Weight: 438 g (cuff + batteries included)
 Measuring method: Oscillometric, with automatic inflation and deflation
 Power: 4x1.5V size AAA batteries
 Battery life: 250 measurements
 Range: Sys: 60-260 mmHg,
 Dia: 40-199 mmHg
 Pulse rate range: 40-180 bts/min

3 iHEALTH ARM B.P. MONITORS



Smart and thin blood pressure monitor with direct visualization on its LED screen of the last blood pressure measurement



Easily saves all your measurements into the iHealth MyVitals App thanks to Bluetooth 4.0 synchronization

Weight: 232 g

- 23500 iHEALTH BP55 ARM B.P. MONITOR - without display
- 23495 iHEALTH NEO BP55 ARM B.P. MONITOR - with display - available March 2018
- medically validated blood pressure monitors
- easy to read wide Backlit screen (only 23495)
- measurement of blood pressure (systolic, diastolic) and of heart rate (number of beats per minute)
- detection of arrhythmia
- multiple users and unlimited memories
- view historical readings and WHO classification
- Multilanguage box and manual: GB, FR, IT, ES, DE, GR, PT, NL.

TECHNICAL SPECIFICATIONS
 Connectivity: Bluetooth 3.0 (23500) 4.0 (23495)
 Dimensions: 135x55x12 mm (23495), 145x58x30 mm (23500)
 Screen dimensions: 30.4x27.8 mm (23495 only)
 Cuff circumference: 22-42 cm
 Measuring method: Oscillometric, with automatic inflation and deflation
 Power: DC: 5 V, 1.0 A, 3.7 V, Li-ion battery
 Range: Sys: 60-260 mmHg ±3 mmHg
 Dia: 40-199 mmHg ±3 mmHg
 Pulse: 40-180 bts/min



23500

4 iHEALTH WRIST B.P. MONITORS



Motions Sensor Technology: does not allow to take BP in case BP monitor is not correctly positioned

- 23501 iHEALTH SENSE BP7 WRIST B.P. MONITOR
- 23502 iHEALTH VIEW BP7s WRIST B.P. MONITOR - with display
- medically validated blood pressure monitor
- easy to read wide Backlit screen (only 23502)
- measurement of blood pressure (systolic, diastolic) and of heart rate (number of beats per minute)
- detection of arrhythmia
- best wrist position sensor for optimum measurement
- evaluation of measurements as recommended by the WHO*
- Multilanguage box and manual: GB, FR, IT, ES, DE, GR, PT, NL.

TECHNICAL SPECIFICATIONS
 Connectivity: Bluetooth 4.0
 Dimensions: 72x74x17.6 mm
 Screen dimensions: 44x26 mm
 Cuff circumference: 13.5-22 cm
 Measuring method: Oscillometric, with automatic inflation and deflation
 Power: DC: 5 V, 1.0 A, 1x3.7 V, Li-ion 400 mAh
 Range: Sys: 60-260 mmHg
 Dia: 40-199 mmHg
 Pulse: 40-180 bts/min
 Weight: 120 g



23502

*World Health Organization

iHEALTH WIRELESS PERSONAL HEALTHCARE PRODUCTS

5 iHEALTH LITE SCALE

BMI function in the App



Switchable kg/lb

23506



• 23506 iHEALTH LITE HS4 WIRELESS SCALE

A high quality design digital scale, with slim lightweight design and reliable tempered glass platform, iHealth scales work online and offline. Thanks to the iHealth MyVitals App it is possible to view single readings or long term trends, track calories and daily activities, set target goals for weight management, organize records with personalized graphs and unlimited memories.

TECHNICAL SPECIFICATIONS

Max weight capacity:	180 kg (400 lbs)
Size:	350x350x28.5 mm
Accuracy:	±1%
Batteries:	4x1.5 V AAA included

6 iHEALTH CORE BODY ANALYSIS SCALE



23508



• 23508 iHEALTH CORE HS6 WIRELESS BODY ANALYSIS SCALE

Weight monitoring and body composition on iPhone, iPad and Android smartphone. It allows to:
 - measure weight, BMI (Body Mass Index), lean, bone, muscle, water mass, body fat and visceral fat rating
 - estimate daily caloric intake
 - display room temperature and humidity
 - track data, graphs and history on the iHealth MyVitals App
 - define goals to stay motivated
 - store unlimited measurements
 - share your medical data with your healthcare professional or family
 Wi-Fi Sync, easy installation.
 Secure and free data storage.

TECHNICAL SPECIFICATIONS

Connectivity:	Wi-Fi
Dimensions:	350x350x28.5 mm
Weight:	2,500 g
Battery:	4 AAA batteries 1.5 V (included)
Range:	5-180 kg
Accuracy:	±1 % (50-180 kg)



For iOS and Android version 4.0 +
 See the list of compatible devices on ihealthlabs.eu/support

iHEALTH GLUCOSE MONITORS - iHEALTH GLUCO APP

• 23510 iHEALTH GLUCO BG5 SMART GLUCOSE MONITOR KIT

• 23514 iHEALTH GLUCO BG5 SMART GLUCOSE MONITOR

Pocket sized, ergonomic wireless glucose monitor with advanced technology and high reliability. The Wireless Smart Gluco-Monitoring System is a convenient way to measure and record your blood glucose levels from your mobile device.

- view results instantly on the wireless meter
- save up to 500 test results on the wireless meter
- set up reminders and view glucose and insulin trends in multiple ways
- track test strip quantity and expiration dates automatically, no counting or coding required
- works on-line and off-line, with data automatically uploading at each connection.

Kit 23510 includes 10 test strips, 10 lancets, lancing device, control solution. Both include USB charging cable and travel case.

• 23509 iHEALTH ALIGN - BG1 GLUCOMETER

Economic, button size model with advanced technology and good reliability. A convenient way to measure your blood glucose monitor and transmit by your iPhone.



23510



23509

iHealth Gluco-Smart App. Available in GB, FR, IT, ES, DE, CZ, SK, HR, TR, IR, CN Arabic.

	TECHNICAL SPECIFICATIONS
Machine size:	90x34.5x19 mm (23510-14) - 53x30x96 mm (23509)
Measuring method:	Amperometric technology using glucose oxidase
Result range:	20 mg/dL-600 mg/dL (1.1 mmol/L-33.3 mmol/L)
Power source:	DC 3.6 V (23510-14) - DC 3.0, CR 1620 (23509)
Blood source:	Fresh capillary whole blood
Blood volume:	Min. 0.7 micro liter

code	GLUCOSE MONITOR ACCESSORIES
23511	Glucose strips* - box of 25
23512	Glucose strips* - box of 50
23916	Lancets 28G - box of 100
23915	Auto lancets device "On Call"

Ear phone universal plug compatible with any mobile

*No coding strips: no need to calibrate glucometer any time. These strips are automatically identified by glucometer.

iHEALTH PRO THE APPLICATION FOR HEALTH PROFESSIONALS

iHEALTH PROFESSIONAL APP - free

To manage wireless:

- 3 iHEALTH B.P. MONITOR - ARM
- 6 iHEALTH BODY ANALYSIS SCALE (9 parameters)
- 1 iHEALTH PULSE OXIMETER
- 7 iHEALTH GLUCOSE MONITOR
- 8 iHEALTH CARDIOLAB
- 9 iHEALTH AMBULATORY B.P. MONITOR - 24 hours



The iPad application for health professionals that enables to monitor patient health data. Use iHealth Pro allows:

- measure the vital signs of patients with connected iHealth health products
- create "patient files", and synchronize their health data in the iHealth Pro App
- integrate self-measurement data of patients from their iHealth My Vitals application in the iHealth Pro application
- follow and retain the measurements of patients using clear graphs and history
- generate reports in PDF format for printing and sharing with colleagues

All products have 2 years warranty.

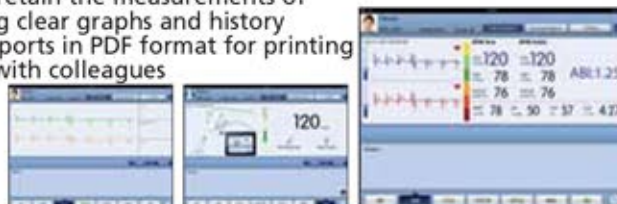

8 iHEALTH CARDIOLAB WIRELESS CARDIOVASCULAR MONITORING SYSTEM (ABI)



Cardiolab includes 2 pressure cuffs, USB cable and manual (GB, IT, FR, DE, ES, NL). Tablet not included.



• 23520 iHEALTH WIRELESS CARDIO LAB

Cardiovascular and blood pressure monitoring system with multiple sensors that allow the user to make simultaneous measurements on several limbs in real-time. CardioLab measures ABI (ankle brachial index) and calculates other cardiovascular parameters such as MAP, PP, cardiac output and stroke volume. It provides a full cardiovascular risk assessment according to internationally recognized standards and provides users with an intuitive way of measuring ABI and other cardiovascular parameters and brings detailed vascular assessment within the reach of general practitioners.

Early detection of peripheral arterial disease

The ankle brachial index (ABI) is the best predictor of cardiovascular morbidity and mortality of heart attacks and strokes. It is an essential component for the screening, diagnosis and management of peripheral arterial disease (PAD). It offers a simple, rapid and cost-effective method for evaluation of the distal perfusion of lower and upper limbs. Cardio-Lab makes a measurement of ABI in less than 3 minutes and gives a fully comprehensive picture of the arterial state

of the patient. The iHealth CardioLab is a simple, accurate and effective way of calculating the risk of strokes and heart attacks in routine medical examinations, is an excellent predictor of peripheral arterial disease (PAD) and should be used in routine examinations of patients.

Track the vital signs of your patients in less than 3 minutes:

- Blood pressure (SYS, DIA)
- Heart rate
- Stroke Volume (SV)
- Ankle Brachial Index (ABI)
- Arrhythmia detection
- Mean Arterial Pressure (MAP)
- Cardiac Output (CO)

Intuitive iPad-driven software

The iHealth CardioLab uses electronic palpation technology that combines all the advantages of manual palpation with the speed and accuracy of modern day electronics. It revises the art of palpation using direct oscillometric data obtained from the human body and translating it into a comprehensible format, measuring not only blood pressure, but also mean arterial pressure, pulse pressure, ankle brachial index, stroke volume and cardiac output.

Track automatically. Know instantly.

- Measure ABI and blood pressure directly from your iPad
- Record systolic/diastolic numbers, heart rate, and pulse waves
- View historical readings and World Health Organisation's (WHO) classifications through colourful, easy-to-read displays
- Generate custom graphs by date and time or systolic/diastolic numbers
- Share results instantly
- Unlimited users and memory



TECHNICAL SPECIFICATIONS

Classification:	Internally powered, Type BF applied part, IPX0, No AP or APG, continuous operation
Measuring method:	Oscillometric method, automatic inflation and measurement
Memory:	9999
Battery:	1x3.7 V Li-Ion 400 mAh
Power:	DC: 5V 1.0A
USB charge:	
Measurement range:	Cuff pressure: 0-300 mmHg ±3 mmHg
	Systolic: 60-260 mmHg
	Diastolic: 40-199 mmHg
	Pulse rate: 40-180 beats/minutes ±5%
Cuff size:	145x58x30 mm
Weight:	135 g
Cuff circumference:	22-42 cm (universal cuff)
Wireless communication:	Bluetooth V3.0 + EDR Class 2 SPP
Frequency band:	2.402-2.480 GHz

9 iHEALTH CARDIOMED - 24 h

• 23536 iHEALTH CARDIOMED - 24h ABPM

- measurement at regular intervals of blood pressure (systolic, diastolic) and heart rate (number of beats per minute)
- detection of arrhythmia
- up to 24h monitoring
- universal cuff (22-42cm)
- thin, light and forgettable
- activity and posture detection during measurements
- Bluetooth sync
- secure and free data storage

- import your patient home-monitoring data into the iHealth PRO App
- Supplied with USB cable and manual (GB, FR, IT, ES, DE).



TECHNICAL SPECIFICATIONS

Connectivity:	Bluetooth 4.0 / Micro-usb	Weight:	110 g
Dimensions:	135.5x55x12 mm		
Memory slots:	1x200		
Measurement method:	Oscillometric		
Measurement range:	300 mmHg, 40-180 pulse/min	Accuracy:	±3mmHg, ±5%
Power Source:	1x3.7 V Li-Ion 800 mAh		

23536



Easy sample application with capillary action

GLUCOSE MONITORS FOR DAILY DIABETES TESTING

Advanced technology glucose monitors. Available as unit only or complete kit. Kit includes 10 strips, code chip, control solution, 10 sterile lancets, lancet device, clear cap (for testing on forearm or palm), carrying case, user manual.

Main features:

- accurate result in just 5 seconds
- only 0.5 µl sample size
- automatic calibration with code chip
- plasma calibration results
- advanced data management with 7, 14, 30 days average
- affordable for frequent monitoring
- flexibility to test on the forearm, palm or fingertip
- certified ISO 15197:2013

- BIOSENSOR TECHNOLOGY
- 5 SECOND TEST TIME
- ONLY 0.5 µL BLOOD SAMPLE

TECHNICAL SPECIFICATIONS

Measurement Range	20 to 600 mg/dL or 1.1 to 33.3 mmol/L
Sample Sites - Size	Finger tips, Forearm or palm - 0.5 µL
Test Time	Approximately 5 seconds
Power Source	One 2032 or equivalent 3.0 V coin cell battery
Battery Life	12 months or approximately 1,000 tests
Memory	Up to 300 records with time and date

mg/dL		mmol/L		ON CALL® PLUS II GLUCOSE MONITOR
Italian	English	Spanish	English	Glucose monitor Plus-meter only
Greek	French	Portuguese	French	
23890	23891	23892	23881	Glucose monitor Plus-kit
23895	23896	23897	23886	
Accessories and consumables for				
code GLUCOSE MONITOR ON CALL® PLUS AND ON CALL® PLUS II				
23910	Glucose Strips - box of 25 strips			
23912	Glucose Strips - box of 50 strips			
23913	Glucose Strips - box of 100 strips			
23914	Control Solution			
23919	Auto lancet device			
23917	Lancets 28G for 23919 - sterile - box of 25 pcs			
23916	Lancets 28G for 23919 - sterile - box of 100 pcs			



CE 0123

23891

Easy calibration with chip PLASMA calibration results

23896

ABBOTT GLUCOSE STRIPS



Abbott

ABBOTT FREESTYLE OPTIUM BLOOD GLUCOSE TEST STRIPS		
code	Compatibility	Minimum order
23942	FreeStyle Optium Neo, FreeStyle Libre, FreeStyle	box of 25
23943	Optium, Optium Xceed, Optium, Optium Easy, Boots	box of 50
ABBOTT FREESTYLE LITE BLOOD GLUCOSE TEST STRIPS		
23944	FreeStyle Lite, FreeStyle Freedom Lite,	box of 25
23945	FreeStyle InsuLinx, FreeStyle Navigator II	box of 50

LANCETS AND LANCET DEVICE

- 23919 AUTO LANCET DEVICE
Reusable auto lancet plastic device, adjustable tip, allows precise configuration of lancet penetration.



23916

- 23917 GIMA LANCETS - 28G - sterile - box of 25 pcs
 - 23916 GIMA LANCETS - 28G - sterile - box of 100 pcs
- Lancets are fine needles that can be used with code 23919 and most of lancet devices in the market to draw a blood sample for glucose testing. Multilanguage box: GB, FR, IT, DE, ES, PT, GR, PL, Arabic.



23917



23916-17

SURVILANCE SAFETY AUTOMATIC LANCETS

SURVILANCE SAFETY AUTOMATIC LANCETS - NEEDLES

Multi purpose capillary blood sampling devices for all testing requirements.

The one-step safety lancet is easier to use, no arming is required, and safer, once lancet is used it is rendered inoperable.

High-speed delivery and penetration method minimizes patient pain and operator error.

Latex-free, hypo-allergenic, disposable, sterile.

SURVILANCE™ SAFETY LANCETS - NEEDLES							
code	Colour	Depth of penetration	Entire needle Gauge	Needle tip Gauge	Blood Flow	Finger Stick Glucose Hematocrit	Minimum order
24513	Yellow	1.0 mm	G21	G26	5-10 µl	• •	box of 100
24514	Grey	1.8 mm	G21	G23	10-20 µl	• •	box of 100
24515	Orange	2.2 mm	G21	G22	20-40 µl	• • •	box of 100
24517	Pink	2.8 mm	G21	G21	40-60 µl	• • • •	box of 100



Multilanguage manual on www.medipurpose.com

CE 1008

Multilanguage box: GB, FR, IT, ES, DE, PT, NL, SE, DK, RU, GR.

24515

MULTICARE "IN" - SELF CONTROL OF RISK FACTOR

- 23965 MULTICARE "IN" KIT - Italian manual
- 23966 MULTICARE "IN" KIT - English manual
- 23967 MULTICARE "IN" KIT - CD multilanguage manual*

*Includes 11 languages: GB, IT, FR, ES, GR, PT, PL, SL, HU, TR, DE

A new approach for the periodical self-monitor of risk factors - cholesterol, triglycerides and glucose. The only device on sale with reflecto-metrical and electro-chemical bio sensor suction. Multicare "IN" is supplied in cardboard box with a nylon bag, 10 glucose strips, lancet device, 10 lancets, rapid guide and user manual. Multilanguage box: GB, FR, IT, ES, GR, PT, PL.

The first and only multi-parameter device with double technology
BIOSENSOR SUCTION STRIP - glucose

- Electro-chemical technology for a practical use.
- Requires very little blood samples (1 µl).
- Short time for the results (5 sec.)



REFLECTOMETRIC SUCTION STRIP - cholesterol and tryglicerides

- multiCare in is a unique technology.
- It allows a more functional self-monitoring of triglycerides and cholesterol.



Tube of 5	Tube of 25	Tube of 50	SPARE STRIPS FOR MULTICARE "IN" 7 LANGUAGE BOX
-	23969	23970	Glucose strips biosensor + 1 chip
23971	23972	-	Cholesterol strips + 1 chip
23973	23974	-	Triglycerides strips + 1 chip
CONTROL SOLUTION FOR MULTICARE "IN"			
23978	Glucose control solution		
23979	Cholesterol control solution		
23980	Triglycerides control solution		
LANCETS FOR MULTICARE AND MULTICARE "IN"			
23917	Lancets 28G - sterile - bag of 25 pcs		
23916	Lancets 28G - sterile - box of 100		

- 23982 SOFTWARE FOR MULTICARE "IN" - GB, FR, IT, ES
- Operating system: Windows XP, Windows 7 and 8, Vista, 16 Mb Ram, 10 Mb remaining space on hard disk.

multiCare in

CE 0344



Strips are sold in a 7 languages box: English, Italian, French, Spanish, Greek, Polish, Portuguese.



3 IN 1: CHOLESTEROL, TRIGLYCERIDES, GLUCOSE BIOSENSOR

23965

TECHNICAL SPECIFICATIONS

	Measuring range	Measuring time	Blood sample
Glucose electro-chemical:	10-600 mg/dl	5"	1 µl
Cholesterol	130-400 mg/dl	30"	10 µl
Triglycerides	50-500 mg dl	30"	10 µl
Memory:	500 test results with date and time		
Batteries:	2 lithium batteries Cr 2032 3 Volts (32212)		
Size - weight:	97x49x20.5 mm - 65 g		

CHOLESTEROL, TRIGLYCERIDES, GLUCOSE STRIPS FOR MULTICARE

Tube of 5	Tube of 25	Tube of 50	STRIPS AND CONTROL SOLUTION FOR OLD MULTICARE (23948, 23950)
-	23955	23956	Glucose strips + 1 chip
23957	23958	-	Cholesterol strips + 1 chip
23959	23960	-	Triglycerides strips + 1 chip
	23961		Glucose control solution (3"x2.5 ml)
	23962		Cholesterol control solution (2x2.5 ml)
	23963		Triglycerides control solution (2x2.5 ml)

*Level low, normal, high

Each strip box has its own coded chip for safe measurement



MISSION® CHOLESTEROL METER + LIPID PANEL TEST

- 23932 MISSION® CHOLESTEROL METER

Provides high quality and reliable results for complete Lipid Panel testing in 45 seconds.

3 in 1 complete Lipid Panel device tests for Total Cholesterol (CHOL), High Density Lipoprotein (HDL) and Triglycerides (TRIG)

Also includes calculated tests: Low Density Lipoprotein (LDL), CHOL/HDL ratio and Cardiac Risk Assessment

Reliable

- can test whole blood, serum or plasma
- wide hematocrit range of 0-50%
- small printer available for immediate printing of results

Easy to use

- large LCD display for easy reading
- colour coded test devices with engraved test name for easy identification
- battery operated

Supplied with 5 safety lancets, 2 control devices, 4 batteries, carrying case and manual (GB, IT)

Available FR,ES, DE, PT manual in www.gimaitaly.com

Multilanguage box: GB, FR, IT, ES, DE, PT, PL, SE, FI, GR, NL, RO, BG, RU, SA



23932

	TECHNICAL SPECIFICATIONS
Detection principle	Reflectance Photometry
Time to results	45 seconds-2 minutes
Memory with date/time	200 results
Type of test	Quantitative
Tests	CHOL, HDL, TRIG
Calculated tests	LDL, CHOL/HDL ratio, Cardiac Risk Assessment
Specimen volume	3-1 Lipid Panel Device: 35 µl CHOL Individual Test Device: 10 µl
Measurement units	mg/dL or mmol/L
Measurement range	CHOL: 100-500 mg/dL (2.59-12.93 mmol/L) HDL: 15-100 mg/dL (0.39-2.59 mmol/L) TRIG: 45-650 mg/dL (0.51-7.34 mmol/L)
Pc interface for data transfer	Mini USB Port
Calibration	Code Chip
Languages on the screen	English abbreviations
Power source	4 AAA or AC Adaptor (Mini USB, 5V dc, 50 mA)
Battery life	≥ 1,000 tests
Automatic shut off	5 minutes
Meter dimensions	137x79x26 mm (5.4" x 3.1" x 1.0")
Display dimensions	50x50 mm (2.0" x 2.0")
Weight excluding batteries	145 g (5.11 oz)

code	ACCESSORIES AND SPARES	Minimum order
23933	3 in 1 Lipid panel tests + capillary tubes 35 ml	box of 25
23934	Total Cholesterol tests + capillary tubes 10 ml	box of 25
24024	Capillary transfer tubes 10 ml - plastic	box of 50
23917	Gima lancets 28G	box of 25
23916	Gima lancets 28G	box of 100
23919	Auto lancet device - AST method	-
23929	Mission printer*	-
33250	Thermal paper roll 57 mm x 25 m	box of 5

*Includes 1 paper roll, cable, adaptor

LUX: PROFESSIONAL MONITORING OF LIPIDS, GLUCOSE AND HEMOGLOBIN



TOTAL CHOLESTEROL

HDL

LDL
*calculated value

TRIGLYCERIDES

GLUCOSE

HEMOGLOBIN

• **23983 LUX MONITOR for lipid, glucose and hemoglobin**
The cardiovascular diseases are linked to the concentration of cholesterol in the blood. Many people don't know that their cholesterol is high or do not monitor it. Lux gives benefit to doctor to do a complete lipid screening plus glucose and hemoglobin in less than 3 minutes.

Easy
Only 45 µl for the complete lipid panel, 7 µl for the hemoglobin, 0.5 µl for the glucose.

Effective
Doctor can test during consultation with patient.

Complete lipid panel in 3 minutes
Measurement of cholesterol, triglycerides, HDL, LDL at the same time in less than 3 minutes.

Additional hemoglobin and glucose test **23983**
Software for download PC (GB, IT)

Optional data reading software (CD + cable) for easy download. Lux monitor is supplied with carrying bag, pipette 15 µl, pipette 7 µl, 3xAAA batteries 1.5 V and manual (GB, IT). Made in Italy.



*CHOL/HDL & LDL/HDL ratio calculation

code	ACCESSORIES AND SPARES	Minimum order
23984	Lipid strips with tips and chip - need 23997	box of 10
23985	Hemoglobin strips with chip - need 23998	box of 10
23986	Glucose strips	box of 50
23987	Lipid control solution with chip - 2 ml	3 bottles*
23988	Hemoglobin control solution - 2 ml	1 bottle
23989	Glucose control solution - 2 ml	1 bottle
23997	Pipette 15 µl for lipid	-
23998	Pipette 7 µl for hemoglobin	-
23999	Software (CD + cable)	-

*1 bottle for each parameter (total cholesterol, triglycerides, HDL)

TECHNICAL SPECIFICATIONS LUX MONITOR	
Number of measurements	More than 500 measurements (lipid) or more than 1'000 measurements (glucose or hemoglobine)
Method of measurements	Lipids and Hemoglobin: optical method, Glucose: electrochemical method
Display	LCD (LED Backlight)
Operation buttons	3 buttons (ON/OFF switch, up button and down button)
Memory	1'000 readings
Function	Average of glucose measurements (7, 15, 30 days)
Power source	3XAAA 1,5 V alkaline manganese batteries

TECHNICAL SPECIFICATIONS - STRIPS	
Measuring method	Photometric, amperometric only for glucose
Test range	Total Cholesterol: 100-400 mg/dL, Triglycerides: 50-600 mg/dL, HDL: 20-80 mg/dL, Hemoglobin: 5-25 g/dL, Glucose: 20-600 mg/dL
Measuring unit	mg/dL (standard), mmol/L (settable by user)
Measuring time	Lipids: within 3 min.; Hemoglobin: 5 sec.; Glucose: 5 sec.
Sample volume	15 µl Cholesterol, Tryglicerides, HDL each test; 7 µl Hemoglobin; 45 µl Lipid 3 tests; 0,5 µl Glucose
Type of sample	Lipids and Hemoglobin: fresh capillary blood for self-monitoring and professionals (venous blood samples must be withdrawn by a healthcare professional); Glucose: fresh capillary blood

MISSION® PT/INR COAGULATION MONITORING SYSTEM

• 23926 PT/INR COAGULATION MONITORING SYSTEM

Coagulation testing for professional and self use

Reliable

- quick results for Prothrombin Time (PT) in seconds and International Normalized Ratio (INR)
- large INR range of 0.7-7.0
- individually packaged strips with 24 months shelf life
- external optional printer available for quick printing of results
- clinical accuracy: ISO 17593 compliant

Simple operation

- results in about 2 minutes
- requires only a single drop of capillary blood or 15 µL of venous whole blood
- insert strip, apply specimen and read results

User friendly

- handheld portable meter easy to use and ideal for physician offices and home testing
- includes lockout functions and the capability to store patients ID's
- operates with battery or standard AC adaptor



23926 CE 0123

code	ACCESSORIES AND SPARES	Minimum order
23927	PT test strips with chip	box of 12
23928	PT test strips with chip	box of 48
23931	Control solution	1 kit**
24515	Surgilance safety lancets 22G	box of 100
33250	Thermal paper roll 5.7 cm x 25 m	box of 5
23929	Mission printer* - need cable 23930	
23930	Cable printer to PT/INR	23929

*Supplied with 1 paper roll, adapter, package insert

**Includes 5 level-1 and 5 level-2 0.4 ml bottles, 1 insert, 1 plastic clamp

STANDARD ACCESSORIES		
1 quick reference guide	1 AC adaptor	4 AA batteries
1 carrying case	1 user's manual (GB, IT)	on request DE, ES, PT

TECHNICAL SPECIFICATIONS	
Methodology	Optical fluorescence
Time to results	About 2 minutes
Memory	200 results with date/time
Specimen volume	15 µL
Specimen type	Fresh capillary or venous whole blood
INR measurement range	0.7-7.0
HCT range	25-60 %
Precision	Repeatability and total precision <10%
Accuracy	Y=1.076X-0.078, R=0.924
PC interface	Mini USB
Power source	4 AA batteries or AC adaptor
Battery life	>100 tests
Meter dimension (LxWxH)	152x72x37 mm (6.0"x2.8"x1.5")
Display dimension (LxW)	46x23 mm (1.8"x0.9")
Weight excluding batteries	170 g (6.0 oz)



LACTATE SCOUT+: FAST AND ACCURATE LACTATE MEASUREMENT

23990 LACTATE SCOUT+

Pocket device for fast, accurate and reliable lactate measurement.

Easy to use:

- only 0.5 µl of capillary blood required
- pre-calibrated sensors
- device calibrated by simple coding
- lactate measurement, date/time, mode, temperature and memory ID on a single display

Stores over 250 results

Fast and accurate:

- enzymatic amperometric detection method
- results within 10 seconds
- measuring range: 0.5 - 25 mmol/L (±3%)

Measuring range:
0.5 - 25 mmol/L ±3%

Performance measurement:

- single and step-test measurements (resting/exercise/recreation)
- stopwatch and countdown timer functions

Integrated bluetooth technology and PC software:

An USB key allows easy transfer to PC and a 4 language (GB, DE, IT, ES) software allows easy data management. Supplied with nylon bag, 10 lancets, 6 strips, control solution, 2x1.5 AA batteries, USB key, English manual, CD manual and box (GB, FR, IT, DE, ES, DK, FI, NO, RU, SE, TR, CN), CD quick guide (BG, CZ, EE, GR, HR, HU, LT, LU, LV, PL, PT, RO, RS, SI).

23991 STRIPS - tube of 24 pcs

24513 ONE-STEP SAFETY AUTOMATIC LANCETS - box of 100



CE 0123

FDA

Pocket size:
91x55x24 mm
Weight: 80 g

23990

Integrated bluetooth connectivity

Easy handling in 3 steps

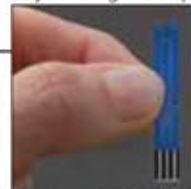

Remove sensor and place into analyzer



Prick finger and collect blood by touching sensor



Results appear in 10 seconds

HEMO CONTROL: HEMOGLOBIN MEASURER AND HEMATOCRIT

23994 HEMO CONTROL

Fast, simple and accurate determination of hemoglobin and hematocrit in whole blood:

- two tests in one
- fast results in 25 to 60 sec
- limited sample volume 8 µl
- graphical touch screen
- no calibration required, automatic self test
- memory: 4,000 results including date and time
- Hb con-low, Hb con-norm, Hb con-high
- integrated rechargeable battery (100 hours)

Compact size only
160x160x68 mm
Weight: 700 g

23995 HEMOGLOBIN MICROCUVETTES - box of 50

24513 ONE-STEP SAFETY AUTOMATIC LANCETS - box of 100

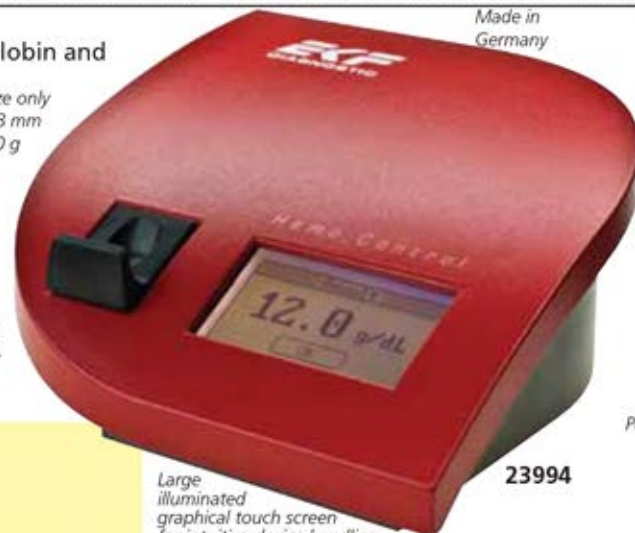

Made in Germany

Easy handling in 3 steps

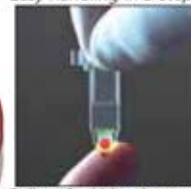

Collect 8 µl blood sample



Put microcuvette into analyzer



Read results on display in 25-60 sec

23994

Large illuminated graphical touch screen for intuitive device handling

Supplied with transformer (to recharge battery), control cuvette and kit for cleaning. English manual, CD manual (GB, FR, IT, DE, ES, PT, PL, RU)

TECHNICAL SPECIFICATIONS	
Measurement method:	photometric, azidemethemoglobin
Measuring range:	0 - 25.6 g/dL; 0 - 15.9 mmol/L
Sample volume:	8 µl
Sample material:	venous, arterial or capillary blood
Precision:	<2%
Linearity:	0 - 20 g/dL ±0.3 g/dL >20 g/dL ±0.7 g/dL
Calibrated to:	NCCLS standard
Operating power:	110-250 V - 50/60 Hz; integrated battery (approx 100 h use)

MISSION Hb HEMOGLOBIN TESTING SYSTEM

24022 MISSION Hb HEMOGLOBIN TESTING SYSTEM

Accurately detects Hb and Hct levels. Professional use.

Quick

- Hemoglobin (Hb) and Hematocrit (Hct) results in < 15 seconds
- simply insert strip, apply specimen and read results
- features auto-calibration
- no specimen preparation required

Accurate

- only 10 µL capillary or venous blood required
- precise results equivalent to automatic hematology analyzers
- wide Hb measurement range of 4.5-25.6 g/dL with Hct range of 13-75%
- stores up to 1,000 results

Portable

- operated by battery
- handheld for immediate diagnosis
- dry strips eliminate inconvenience in shipping and storage of liquid reagents

Convenient

- can test capillary and venous whole blood
- minimal training required
- quick data transfer via Mini USB port

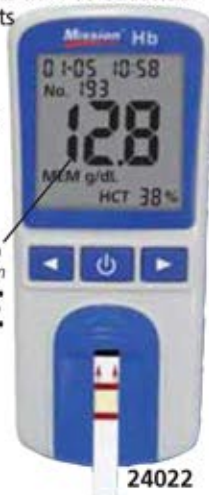

Large LCD 39x37 mm

CE

24022

Multilanguage box:

GB, FR, IT, ES, PT, DE, PL, RO, SE, FI, GR, TR, Arabic.

- 24023 TEST STRIPS - box of 50 + 1 code chip
- 24024 CAPILLARY TRANSFER TUBES 10 ml - plastic - box of 50
- 23916 GIMA LANCETS 28G - sterile - box of 100
- 23919 AUTO LANCETS DEVICE - AST method
- 24513 SURGILANCE SAFETY LANCETS 26G - sterile - box of 100

TECHNICAL SPECIFICATIONS

Methodology	reflectance Photometry
Detection	principle Methemoglobin
Time to results	< 15 seconds
Memory	1,000 tests with date/time and ID number
Specimen volume / type	10 µL / capillary and venous whole blood
Hb measurement range	4.5 - 25.6 g/dL Hct range 13 - 75%
Wavelengths	525 nm
Calibration	automatic
Hb within run precision CV	≤ 3%
Accuracy	Hb 4.5 - 10 g/dL, ±0.4 g/dL; Hb 10 - 25.6 g/dL ± 4%
Power source	3 AAA Batteries or AC Adaptor on request
Battery life	2,700 tests or 360 hours
Automatic shut off	8 minutes
Size (LxWxH)	127x58x25 mm (5.0"x2.28"x0.09")

STANDARD ACCESSORIES

10 test strip	1 code chip	3 AAA batteries
10 lancets (26 G)	2 control strips	1 carrying case
1 lancing device	10 capillary transfer tubes - plastic	user manual GB, IT

Test paper tray to place the strip to be tested

GIMA URINE ANALYZER AND URINE STRIPS

• 24046 GIMA URINE ANALYZER

Gima urine analyzer is a high-precision instrument with advanced technologies for clinical inspection of urine. It offers easy and quick operation, exact results and good repeatability.

Features:

- high-luminance and white LED, features long life and good stability
- large LCD display
- user-friendly interface
- monitoring the whole testing process, and audible-control prompt
- data transmission function.

Application:

- health examination
- chronic diseases, long-term monitoring for nephrotic patients
- convenient point of care testing for doctor

- portable device, for travelling doctors
- use as telemedicine terminal.

Tested parameters

Glucose (GLU), Bilirubin (BIL), Specific gravity (SG), PH, Ketone body (KET), Occult blood (BLD), Protein (PRO), Urobilinogen (URO), Nitrite (NIT), Leukocytes (LEU), Ascorbic acid (VC).

- 24071 11 PARAMETER STRIP - box with 5 pouches of 3 strips
- 24072 11 PARAMETER STRIP - tube of 50 strips

5-key touch control keyboard

USB socket



TECHNICAL SPECIFICATIONS

Working mode:	One-step
Internal language:	Italian and English
Display:	2.4" LCD, resolution: 320x240
Data storage:	500 sample data
Principle:	RGB tricolor test theory
Communication interface:	Micro USB interface, Bluetooth wireless communication
Repeatability:	CV ≤1%

Stability	CV ≤1%
Record mode:	LCD display, flash ROM data storage
Power supply:	Built-in rechargeable lithium battery 3.7 V, 1900 mAh
	Host computer: DC 5 V, 1 A
	Adapter: AC 100-240 V, 50/60 Hz
Test range:	Refer to grads table on www.gimaitaly.com
Dimension - Weight:	126x73.5x30 mm - 0.18 kg

24046

GIMA VISUAL URINE STRIPS

- 24069 10 PARAMETER STRIP - tube of 100 strips
- 24071 11 PARAMETER STRIP - box with 5 pouches of 3 strips
- 24072 11 PARAMETER STRIP - tube of 50 strips

These strips can be used by professionals for visual tests.

11 parameters strips can also be used with Gima urine analyzer (24046) and Bayer CLINITEK-100 reader

- global check/screening for general health condition
- measures level of Leukocytes, Nitrite, Urobilinogen, Protein, pH, Blood, Specific Gravity, Ketone, Bilirubin, Glucose, Ascorbic Acid (24071 and 24072 only) in 1 strip
- check for healthy nutrition, urinary tract infection, tumors, kidney damage, gout, fever, cirrhosis, viral hepatitis, liver disease, congestive heart failure, jaundice, diabetes and acute renal failure.



For professional use only.

FOR PROFESSIONAL USE



CENTRIFUGES FOR PLASMA, URINE AND BIOLOGICAL LIQUIDS

- 24031 UNIVERSAL CENTRIFUGE - 8 tubes fixed rotor
- 24032 UNIVERSAL CENTRIFUGE - 6 tubes horizontally pivoting rotor
- 24040 TEST TUBES 10 ml - box of 100 pcs

The universal centrifuges are the perfect solution for laboratories and doctors' offices. They feature a ZERO-RPM locking lid for safety, digital programming of time ranging from 1-99 minutes and speed ranging from 500-3300 rpm. They accommodate 6 or 8 tubes (3-15 ml). Achieve up to 1364 g.



taking to a perfect separation by centrifugation. They have a DC motor and come with a 110-220 V auto switching power supply. Made in USA. Manual GB, IT.



24031-2

24031

Size: 27x37x37 cm

TECHNICAL SPECIFICATIONS

Nominal speed:	500-3300 rpm (step of 100 rpm)	Normal RFC:	31-1364
Maximum volume:	120 ml	Maximum power:	12 W
Recommendations	Speed	Time	Fuse: 7.2 A
Whole blood	3300	10 min	
Urine	1800	5-10 min	

- 24035 XC-2000 CENTRIFUGE

Very silent centrifuge with 6 tube positions, provided with electronic counter to allow precise speed setting from 1000 rpm to 4000 rpm (500 rpm increments). It is supplied with metal holder for 6 tubes of 10 ml and holder for 6 tubes of 15 ml. Operating time is adjustable from 1 to 60 min. Strong ABS structure.

- 24040 TEST TUBE 10 ml - Ø 16 x 160 mm box of 100 pcs



24035

TECHNICAL SPECIFICATIONS

Power Supply:	220 V - 50 Hz	Power:	80 W
Speed:	Approx 1,000 - 4,000 rpm (increased in increments of 500 rpm's)		
Time:	1-60 min		
Capacity:	15 ml or 10 ml x 6		
Max. RCF:	1,790 g		

ANALYTICON URINE ANALYZER AND URINE STRIPS



• **24049 URILYZER® 100 PRO URINE ANALYZER** - with printer
Urilyzer® 100 PRO is a small urine test strip reader that offers a broad range of optimized features.

The intuitive user interface improves data entry and allows manual entry of colour and turbidity from a predefined list or by an additional comment.

Moreover, the system provides the user with a high level of customization with flexible testing and reporting options. The intelligent database-driven data management provides multiple filter options.

To be used with urine strips 24062 and 24063 only.

CD manual in GB, DE, IT, SE, NO, DK, ES.

Internal software: GB, FR, IT, ES, DE, GR, NO, SE, FI, DK, HU, CZ, RO, RU.

Made in Hungary.

• **33250 PRINTER PAPER 57 mm x Ø 50 mm** - box of 5 rolls

• **24055 CONTROL SOLUTION - 15 ml** - box of 2

TECHNICAL SPECIFICATIONS

Measurements: 50 meas./hour in normal mode, 120 meas./hour in fast mode
Memory: 3,000 patient test results and 1,000 QC Test results
Display: 3.5" QVGA Touch-screen LCD (resolution 240x320)
Printer: Low noise thermal printer with paper roll for about 280 meas
Printout: Current number measurement, Date and time, Serial No. of the meter, patient-ID, Asterisk on pathological results, Parameters can be printed in SI, Conventional or arbitrary units
Accuracy: Meter adjustment in 5 levels according to individual requirements
Type: Reflectance photometer wavelengths: 505, 530, 620, 660 nm
Interfaces: RS232 serial port, USB A, USB B, PS2 (external keyboard, barcode reader), microSD card, Ethernet port, HL7 protocol
Dimensions/Weight: 190x260x77 mm (WxDxH) / 1.5 kg
Power supply: 100-240 V, 50-60 Hz

ANALYTICON COMBI SCREEN® PLUS and SYS - urine strips
Urine strips for visual test or for use with Urilyzer® 100 and CombiScan 100 (24062 and 24063 only).

• **24060 COMBI SCREEN® PLUS** - 3 parameters - tube of 100 strips

• **24061 COMBI SCREEN® PLUS** - 10 parameters - tube of 100 strips

• **24063 COMBI SCREEN® PLUS** - 11 parameters - tube of 100 strips

Results can be read directly on the strip (after about 60 seconds) and compared with the label on the bottle. Combi Screen® Plus offer ascorbic acid

code	24060	24061	24063	24062
Leucocytes		•	•	•
Nitrite		•	•	•
Urobilinogen		•	•	•
Protein (albumin)		•	•	•
pH	•	•	•	•
Blood		•	•	•
Specific gravity		•	•	•
Ketones (acetoacetic acid)		•	•	•
Bilirubin		•	•	•
Glucose		•	•	•
Ascorbic acid	•	•	•	•

*Ascorbic acid protection pad **No ascorbic acid protection pad

protection for glucose and blood tests. Offers relevant reduction of false negatives due to interference with ascorbic acid. Supplied in aluminium tube in single cardboard box. For professional use. Manual in GB, FR, GR, IT, ES, PT, NL, DE. Made in Germany.

• **24062 COMBI SCREEN® SYS** - 11 parameters - tube of 150 strips

Same as code 24063 but without ascorbic acid protection PAD on glucose and blood.



MICROHEMATOCRIT CENTRIFUGE

• **24025 MICROHEMATOCRIT CENTRIFUGE** - 180 sec.

Economic system, easy to use, fully automatic with LED indicators, no vibration, silent, rapid and provided with rechargeable battery.

Useful for: small labs, office labs, blood drawing areas, pediatric, neonatal settings, dialysis centers, emergency room labs, veterinarians, sample prep for stat chemistries.

• **24026 CAPILLARIES for microhematocrit** - tube of 500

Made of glass 9 microliters. Length: 32 mm - Ø 1.5 mm



TECHNICAL SPECIFICATIONS
Power: rechargeable battery (battery charger supplied 100 ÷ 240 V plug in)
Dimensions: 136 mm (L) x 215 mm (W) x 122 mm (H) Weight: approx 1.2 Kg.

STREP-A RAPID TEST, ACCURATE RESULTS IN 5 MINUTES

- 24522 STREP-A - device - box of 20 tests
- 24523 STREP-A - strip - box of 25 tests



Provides accurate results in few minutes, with a simple procedure easy to perform and to interpret. Immediate diagnosis facilitates patient treatment decisions in the same office visit. Room temperature storage. It includes 20 devices or 25 strips tests (single pack), 2 reagents, 20 (or 25) tubes and swabs. Multilanguage manual and package. For professional use.

TECHNICAL SPECIFICATIONS

	24523	24522
Relative sensitivity:	97% (91-99%)	94% (88-98%)
Accuracy:	95% (93-97%)	97% (96-98%)
Relative specificity:	95% (92-97%)	98% (96-99%)

PROCEDURE

- add 4 drops Reagent A, then drops reagent B
- rotate swab 10 times, wait 1 minute, then remove swab while squeezing tube to remove liquid
- place dropper tip to top of tube (24522)
- add 3 drops of specimen (24522)
- immerse strip in specimen (24523)
- read results after 5 minutes



STREP-A DUAL COLOUR RAPID TEST, OPTICAL TECHNOLOGY

- 24519 STREP-A DUAL COLOUR TEST - strip - box of 50 tests
- The new, dual colour rapid test for Strep A uses the antibody labelled colour particles coated at two separate locations in the test device. This new optical immunoassay technology allows greater sensitivity and less false negative results than the conventional single label test, without affecting specificity. The procedure for the user is the same as for the standard test but the result will be easier to view. If Group A Streptococcus is present in the sample, a visible **blue Test Line** will appear to indicate a positive result and a **red Control Line** will also appear to indicate the test is valid. Kit includes 50 test strips, 50 tubes, 50 swabs, 2 reagents and 2 control solutions. Multilanguage box and manual: GB, FR, IT, ES. Professional use.

TECHNICAL SPECIFICATIONS

Relative sensitivity:	95.1% (95%CI:89.6-98.2%)
Relative specificity:	97.8% (95%CI:95.8-99%)
Overall accuracy:	97.1% (95%CI:95.3-98.4%)



Blue test line indicates a positive result, red control line indicates test validity

INFLUENZA A/B TESTS

- 24537 INFLUENZA A/B TESTS - box of 30 tests (3 packs of 10 pcs.)

Influenza A/B is a rapid in vitro test to detect type A and B influenza antigens (nucleoprotein) extracted from the nasal specimens. The test is designed to detect nucleoproteins of Flu-A core subtypes, independent of H and N surface proteins (including H1N1, H3N2, H5N1, H5N3, H7N3, H9N2). A sterile nasal swab allows an easy collection of specimen. Results in 10-15 minutes. Includes rapid influenza A/B test panel, swab, test tube, extraction buffer. For professional use only.

24537



MONONUCLEOSIS TEST

- 24538 MONONUCLEOSIS TEST - box of 20 tests

A rapid test for the diagnosis of Infectious Mononucleosis (IM) to detect Infectious Mononucleosis heterophile antibodies qualitatively in whole blood, serum or plasma. For professional in vitro diagnostic use only. Results in 5 minutes. It includes 20 cassette tests, 20 droppers, buffers and user manual.

24538



■ FOB-FECAL OCCULT BLOOD TEST FOR EARLY DETECTION

• **24530 FOB TEST - box of 25 tests**
 Provides accurate results in few minutes. It facilitates early patient treatment decision. Simple procedure, easy to perform and interpret. No additional equipment required. It includes 25 pcs of collection stick, device test and one buffer bottle.
 For professional use



■ HELICOBACTER PYLORI TEST FOR ULCER SCREENING

• **24528 HELICOBACTER PYLORI TEST - box of 40 tests**
 Helicobacter Pylori is the leading cause of gastric ulcers, this easy to use test allows a quick diagnosis in about 10 minutes. Easy to perform and interpret, no additional equipment required. For professional use.
 Diagnosis of H. pylori infection in adults over 18 years of age.

• **24529 HELICOBACTER PYLORI SELF TEST - box of 1 test**
 Same as 24528 but packed in single box including one automatic lancet, single buffer and user manual. This product is provided with self testing certification to be sold to end users in OTC market.



■ PROSTATE SCREENING - PSA ONE-STEP TEST

• **24534 PSA TEST - box of 25 tests - for doctor/hospital use**
 Provides accurate results in 5-8 minutes.
 - over 98% correlation to lab tests
 - simple, easy to use serum or plasma test
 - detects PSA as low as 4 ng/ml
 - contains everything needed to perform test (except lancets see page 5)
 - for professional use

• **24532 PSA SELF TEST - box of 1 test - for self test - whole blood**
 Same as 24534 with results in 10 min. Packed in single box including one automatic lancet, single buffer and user manual. Provided with self testing certification to be sold to end user.



■ CARDIAC MARKER

• **24525 CARDIAC MARKER**
3 parameters: CK-MB, Troponin, Myoglobin - box of 20 tests
 It allows to check cardiac status and stroke events in just 15 minutes. Ideal to keep under control patients affected by cardiopathies or after heart attack or surgery. Acute Myocardial Infarction-MI (Heart Attack) is responsible for 1 in 5 deaths in the U.S. After 6 hours of AMI onset, the damage to the cardiac muscle is irreversible and permanent. This illustrates that early and accurate diagnosis of AMI is essential. ECG is the most widely used method of MI diagnosis.

Unfortunately, as many as 25% of AMI patients have a normal ECG. GIMA offers an array tests for Biochemical and Protein markers of MI, such as Creatine Kinase Isoenzyme MB (CK-MB), Myoglobin (MB) and Cardiac Troponin I (cTnI) in combination. It includes 20 droppers, 20 cassettes and 1 bottle with dilution solution. For professional use.



■ SEMI-QUANTITATIVE CRP TEST

• **24527 CRP TEST - box of 20 tests**
 Measurement of CRP in whole blood, plasma or serum has two purposes:
 1) hs-CRP levels help in assess the risk of cardiovascular and peripheral vascular disease. Higher hs-CRP values have highest risk of cardiovascular disease.
 2) CRP levels help identify and keep track of infections and diseases that cause inflammation (lymphonoma, lupus, giant cell arteritis, osteomyelitis, rheumatoid arthritis,).
 - use fingerstick whole blood or serum/plasma
 - results within 7 minutes - room temperature storage
 - built in performance control and reference band
 It includes 20 cassette tests with droppers. For professional use.

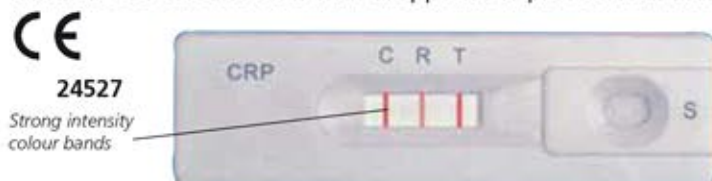

■ MALARIA RAPID TEST

• **24547 MALARIA RAPID TEST - box of 40 tests**
 A rapid chromatographic immunoassay test for the qualitative detection of circulating plasmodium falciparum in whole blood. Compared with traditional thick or thin blood smears microscopic analysis, the correlation between the two systems is over 99,0%. Package includes test devices, buffer, disposable specimen dropper and multilanguage manual, lancets are not included.
 For professional use.



WARNING: SHORT EXPIRY DATE FOR TESTS. Tests have 24 months expiry at production time. Our stock may vary from 10 to 22 months.

DRUG TEST READER SYSTEM - FOR URINE DRUG CUPS/PANELS

- 24570 DRUG READER - Italian software
 - 24571 DRUG READER - English software
 - 24576 MULTI DRUG CUP - 7 drugs + S.V.T.
 - 24577 MULTI DRUG CUP - 8 drugs + S.V.T.
- Simply scan one of the two multi drug test on drug reader and get a complete analysis at your PC.

- automated analysis of "visual read" test panels
- automatic test menu recognition (2D barcode)
- in-process system quality control check
- image capture, data management/export functionality, archived results

Main benefits:

- automation - eliminates results interpretation variability/subjectivity
- accurate, performance advantages vs. visual interpretation
- speed - scanning process requires 15-30 sec.
- flexible - semi-portable, simple installation, Windows compatible. Professional use.

DRUG	24576	24577	CUT OFF NG/ML	Detection time
MTD	•	•	300	5-7 days
MDMA	•	•	500	5-7 days
MET	•	•	500	3-5 days
COC	•	•	300	2-5 days
THC	•	•	50	-
AMP	•	•	500	2-5 days
MOP	•	•	300	5-7 days
BUP	•	•	10	5-7 days
S.V.T.				
OX		•	•	
S.G.		•	•	
PH		•	•	
NIT		•	•	
Glut		•	•	
CRE		•	•	



Suitable in occupational medicine for cost effective workers screening



24576



24577



24576

24577

24570

MULTI DRUG "CUP" TEST

- 24546 MULTI DRUG "CUP" TEST - urine box of 25 tests for 7 drugs

Detects following parameters: (MTD/MDMA)+<COC>+<AMP500>+<MET500>+<THC>+<MOP>. For professional use.

- easy to use - no urine handling, just insert the key into the active test and read results in 5 min.
- tightly sealed urine cup - no leaking or spilling of urine specimen
- unique design - ensures that urine used in the test, will be separated from residual urine, that will remain uncontaminated, to be used for a further test when necessary
- key packed separately, ensures security that only the technician can begin the test

Test panel is tightly fastened to the cup, protecting it from contamination



Temperature label

SCREENING TEST CUP - 24546

DRUG	CUT OFF NG/ML	DETECTION TIME*
MOP	300	5-7 days
COC	300	2-5 days
THC	50	-
AMP	500	2-5 days
MDMA	500	5-7 days
MTD	300	5-7 days
MET	500	3-5 days

* Drug use over detection time not measured

SALIVA DRUG TEST



24555

Collect oral fluid with sponge



- 24555 MULTI DRUG SALIVA TEST oral fluid (saliva) - box of 25 tests for 6 drugs
- Multi drug tests provide accurate results in 10 min. for the following drugs: amphetamine, cocaine, marijuana cannabis, methamphetamine, opiates, phencyclidine. For medical and professional use. Multilanguage manual: GB, IT, FR, DE, ES, PT.

ORAL FLUID SCREENING TEST DEVICE - 24555

DRUG	CUT OFF NG/ML	DETECTION TIME
COC	20	10 min - 24 h
THC	30	up to 14 h
AMP	50	10 min - 72 h
MET	50	10 min - 72 h
PCP	10	-
OPI	40	1 h - more days
MTD	45	up to 2 days

DRUGS OF ABUSE, URINE TESTS FOR PROFESSIONAL USE

- 24540 COCAINE TEST - strip - urine - cut-off: 300 ng/ml
- 24541 MARIJUANA TEST - strip - urine - cut-off: 50 ng/ml
- 24542 OPIATES TEST - strip - urine - cut-off: 300 ng/ml

Codes 24540-41-42 are sold in box of 50 strips individually packed in single pouch.

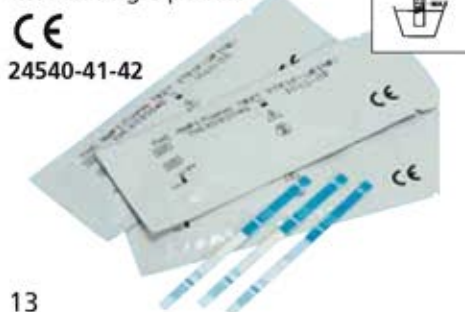

24540-41-42



24550

- 24550 MULTI DRUG PANEL TESTS urine box of 25 tests for 6 drugs*
 - 24549 MULTI DRUG PANEL TESTS urine box of 25 tests for 8 drugs**
 - 24551 MULTI DRUG PANEL TESTS urine box of 25 tests for 12 drugs
- Multi drug tests provide accurate results in 5 min. on the following drugs: amphetamine*, cocaine*, marijuana cannabis*, methamphetamine*, opiates*, phencyclidine*, barbiturates, benzodiazepines, ecstasy, morphine 300, methadone, tricyclic antidepressants.

*Code 24550 contains tests for drugs with asterisk
 **Code 24549 contains tests for drugs with asterisk plus MDMA and 6-AM.
 Cut-off levels meet SAMHSA guidelines.
 Manual: GB, FR, IT, ES, DE, PT.



24551

Drug	SCREENING TEST PANEL			Detection time
	24550	24549	24551	
MOP	-	300	300	5-7 days
COC	150	150	150	2-5 days
THC	50	50	50	5-8 days
AMP	500	500	500	2-5 days
MDMA	-	500	500	5-7 days
MTD	-	-	300	5-7 days
MET	500	500	500	3-5 days
BZO	-	-	300	7-10 days
BAR	-	-	300	2 days - 4 weeks
PCP	25	25	25	-
OPI	2000	2000	2000	5-7 days
TCA	-	-	1000	-
6-AM	-	10	-	-

PROFESSIONAL ALCOHOL TESTER

- 24491 FIT-333 ALCOHOL TESTER with printer **24491**
- 24486 AT500 EASY RECALIBRATION ALCOHOL TESTER with printer - available jan 2018 **24486**
- 24487 PRE-CALIBRATED SENSOR MODULE for 24486 - spare
- 24494 BLOWING TUBES for 24486, 24491 - box of 100 pcs.
- 24495 PAPER ROLLS for 24486, 24491 - box of 10

Size: 188x78x33 mm
Weight: 300 g

Professional fuel cell sensor breath alcohol tester with printer and touch screen. The fuel cell is a porous disk with a thin layer of platinum. Any alcohol that comes in contact with the cell's surface is broken down chemically. For each broken down molecule of alcohol a given number of electrons are freed.

The numbers of electrons generated are in proportion to the amount of alcohol.

Self recalibration (only 24486): easy replacement of pre-calibrated module.

TECHNICAL SPECIFICATIONS

	24491	24486
Display:	Colour 3.2 TFT touch screen LCD	Colour 3.5" touch screen LCD
Keyboard:	5 keys operation: "Up", "Down", "Left", "Right", "OK"	Navigation key input with touch panel
Power Supply:	Rechargeable AA battery (about 2500 mAh)	Rechargeable 7.4 V Li-ion battery
Warm up:	Chamber & Sensor warm up automatically	
Auto flow monitoring:	Automatic flow detection	
Operating environment:	-20° to +70° (optimal -20° to +40°)	-20 to +45°C (optimal 5 to 40°C)
Data download:	USB port	
Compatibility:	Windows XP, 7*	
Memories:	10,000-18,000 memories for approx 3,000 full tests driver name, vehicle number, inspector name, test result with print date and time, location, calibration data, ...	50,000 memories full test
Measurement precision:	Standard deviation ±0,025 mg/L or ±5% of the measurement Drift: typically <0,8% of the measurement value/month	
Calibration*:	by appointed service	by replacement of pre-calibrated sensor module
Unit setting:	mg/L, mg/100 L, %BAC, ‰BAC	

*Need calibration every 12 months **Can export files as Microsoft Excel documents directly (24486 only)



Alcohol testers are supplied with integrated printer, 25 mouth pieces², 1 large mouth piece³, power supply⁴, power supply 100-240V, 50/60 Hz⁵, USB car adaptor⁶, wireless transmission module for FIT-333 printer⁶, carrying pouch¹⁰, 4 rolls of paper¹¹, charger¹².



BREATH ALCOHOL TESTER

- 24500 ALCOHOL TESTER

Compact device to measure your alcohol concentration in your breath.

Digital/graphic interface and animation, one-hand operation.

% BAC and mg/l values.

Supplied in carton box with 3 blowing tubes Ø 7 mm and one cleaning cap.

Multilanguage box and manual: GB, FR, IT, ES, PT

GB, FR, IT, ES, PT

- 24501 BLOWING TUBE - box of 12 pcs.
- 32200 "AAA" BATTERIES - blister of 4 pieces
- 24503 COUNTER DISPLAY - Italian
- 24504 COUNTER DISPLAY - English

SELF MONITORING



Counter display fits 6 tester

Large display to read exact value of your breath (3 colour backlight)

TECHNICAL SPECIFICATIONS

Range: Low & 0.15 - 1.50 ‰ BAC or 0.075 - 0.75 mg/l
Accuracy: ±0.2‰ BAC full range under alert level
Battery: 3 x 1.5V AAA batteries (not included)
Display: Graphic & Digital display with 3 decimal points (eg. 0.025‰BAC)
Tolerance compensation: Pre-alert function together with tri-colour backlighting
Breath sampling: less than 5 seconds continuous breath sample
Recycle time: about 20 seconds
Size: 107x45x25 mm approx.
Weight: 50 g (without batteries)
Alert level calibrated: 0.5 ‰ BAC or 0.25mg/l



POCKET ALCOHOL TESTER

- 24499 POCKET ALCOHOL TESTER

Pocket, easy to use alcohol tester

TECHNICAL SPECIFICATIONS

Range: Low & 0.2 - 1.5 ‰ BAC
Accuracy: ± 0.2‰ BAC at the calibrated point (alert level)
Power input: 2 x 1.5V AAA batteries (not included)
Display: Digital display
Tolerance compensation: pre-alert function when close to alcohol limit
Auto power off: 2 minutes
Breath sampling with auto flow detect: about 6 seconds continuous breath sample
Cycle time: about 20 seconds
Alert level calibrated: 0.5% BAC

POCKET, ONLY 8.5x3x1 cm



SALIVA ALCOHOL STRIPS

- 24502 SALIVA ALCOHOL TEST STRIPS - box of 25 strips

GIMA Saliva Alcohol Test Strip is a rapid highly sensitive test for the determination of relative blood alcohol concentration in saliva specimens.

- results in just 3-5 minutes
- colour chart provides approximate relative blood alcohol concentrations (BAC) from 0.02% to 0.30%
- no instrumentation is required
- saliva testing avoids urine collection
- short expiry date (average 10-22 months)
- professional use



2. Read results in 3-5 minutes

DRUG OF ABUSE SALIVA MULTITEST - 8 DRUGS

- 24566 MULTI DRUG SALIVA MIDSTREAM TEST

oral fluid (saliva) - box of 20 tests

A multi parameters, all-in-one test for simultaneous detection

of 8 different drugs in 10 minutes. Cost effective system for the screening of workers for illicit substance consumption. Professional use.

DRUG OF ABUSE SALIVA MULTITEST			
Drug	Cut off	Drug	Cut off
Opiates	40 ng/ml	Cocaine	30 ng/ml
Morphine	40 ng/ml	Cannabinoids (THC)	25 ng/ml
6-MAM	4 ng/ml	Amphetamine, m-Amphetamine	40 ng/ml
Hydrocodone and Oxycodone	40 ng/ml	MDMA, MDA	50 ng/ml



PROTECTIVE GOGGLES



- 25661 POLYSAFE MEDICAL - bulk
 - 25660 POLYSAFE MEDICAL - with box
- They are a vital part of any infectious disease control programme for eye protection. They provide a wide field of vision and excellent optical quality. Designed with top and side shields to protect eyes from every angle. They can fit all head sizes comfortably, and have superior optical clarity. Autoclavable. Norms EN 166.



- 25659 GIMASAFE - box of 10 pcs
- Transparent protective goggle.



- 25663 HIGH PROTECTION GOGGLES - fog resistant and anti-scratch
- Protection against: droplets and splashes of liquids and high-speed particles at extreme temperature. Lateral protection. Protection against large dust particles (>0.5 μ). Protection against optical radiation to standard EN 170. Resistance to surface damage by fine particles. Resistance to fogging of oculars.



- 25667 PROTECTIVE GOGGLES 5X7 - fog resistant and anti-scratch
- Superior quality goggles with excellent optical quality, high protection and maximum comfort. Optical quality: Class I. **Protection:** protection against high speed particles-low energy and lateral protection. Protection against optical radiations to standard EN 170. Antifog and anti-scratch. **Comfort:** ultra light, soft pad technology temples, adjustable in length. Norms: EN 166.



- 25644 SAN DIEGO GOGGLES - black - fog resistant
 - 25645 SAN DIEGO GOGGLES - blue - anti-scratch
- Temple length and inclination adjustment by snap motion. Protection against high speed particles - low energy and lateral protection. Protection against optical radiation to standard EN 170.



- 25260 505 UP GOGGLES - fog resistant, anti-scratch
- Protection against high speed particles - low energy and lateral protection. Protection against optical radiation to standard EN 170.
- extremely light 24 g only and encircling
 - elastic structure, extremely flexible and resistant
 - optimal comfort and fit thanks to the soft adjustable nosepad
 - neck cord included in the packaging



- 25261 506 UP GOGGLES - green - fog resistant, anti-scratch
 - 25262 506 UP GOGGLES - pink - fog resistant, anti-scratch
- Same as 25260 without neck cord, with below additional features:
- panoramic wrapping lens
 - temple regulation in length and inclination
 - soft terminal tips to eliminate local pressure

VISOR HEAD MASKS

VISOR HEAD MASKS

Great features

- faceshield with 90° rotation
- inner and outer surface treated against mist
- superior coverage to protect against droplets and splashes

Superior materials

- elastic band in anallergic material
- rotation systems in anodized aluminium
- soft support in anallergic interchangeable foam
- faceshield in heat-formed acetate with anti-fog treatment

Easy and comfortable use

- fitting headbands adjustable by velcro fasteners
- usable over ophthalmic glasses

code	VISOR HEAD	Minimum order
25656	VISOR HEAD MASK	1
25668	VISOR SHIELD	1
25669	SPARE SHIELD for 25668	box of 5



TETI PROTECTIVE SHIELDS

- 30863 TETI PROTECTIVE SHIELD - white - 1 shield
- 30860 TETI PROTECTIVE SHIELD - white - 2 shields

Comfortable, ultra light stylish protective shields. They provide high protection from squirts and sprays.

Folding shield behind the nape.

Adjustable size, fits majority of healthcare professionals.

Extra wide visor allows to fit over glasses and most of magnification loupes.

Supplied with 2 face transparent shields and 2 padding with velcro (30860) or 1 shield + 1 pack (30863)

Certificated EN166. Made in Italy.

- 30875 SET OF 5 TRANSPARENT FACE SHIELDS - spare

Adjustable string to securely fasten shield around head

Super soft padding with velcro fixing for comfortable use



TETI FITS IUKO MODULAR SYSTEM AND ANY MAGNIFICATION LOUPE



OP-DOP VISOR SHIELD "PROTECTOR" WITH 3+1 SHIELDS

- 25642 VISOR SHIELD "PROTECTOR" - white

The ultra-light face shield that combines function with style:

protection: a waterproof plastic barrier will protect you

comfort: fast and easy to wear and remove

convenience: reusable and replaceable shield

optical quality: superior optical quality.

Medium adjustable size: fits over 90% of healthcare professionals. Fits over glasses.

Shielded air vent eliminates fogging.

Supplied with 3 face transparent shields + 1 head shield.

- 25643 REPLACEMENT SHIELD KIT

Includes 2 face transparent shields + 1 head shield + 1 foam bumper



GOGGLES KIT



- 25646 GOGGLES KIT - fog resistant
- Practical kit composed of 5 supports in different colours and 20 antifog shields. Usable over ophthalmic glasses.

- 25647 SPARE SHIELDS - box of 20

HIGH PROTECTION MASK 6x1



- 25265 HIGH PROTECTION MASK 6x1 - fog resistant, anti-scratch
- wide lens for a field of view without distortion
 - temples adjustable in length and inclination with SoftPad technology
 - sophisticated indirect ventilation system
 - soft internal rubber for comfort without local pressure
 - certified according to EN166 point 3 (droplets and splashes) and point 4 (large dust particles)
 - supplied with neck cord

99% FILTERING 3 PLY MASKS - WITH LACETS OR LOOPS

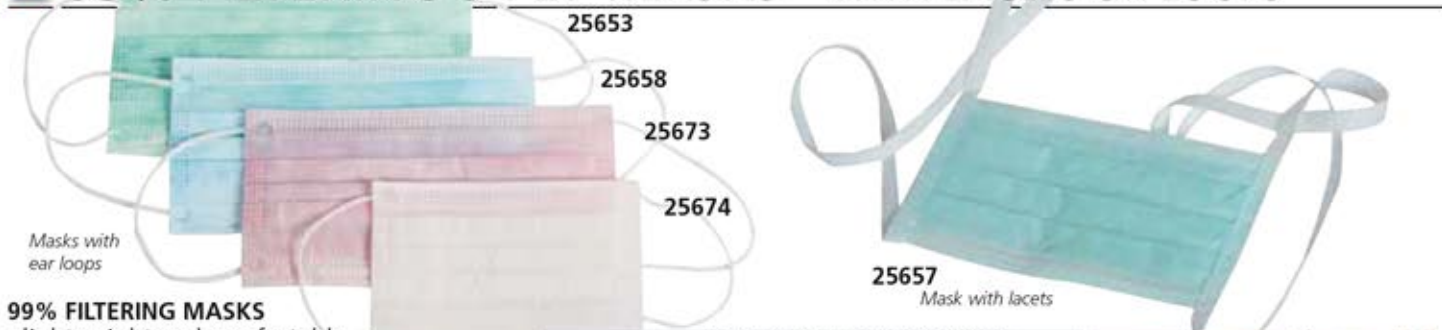

99% FILTERING MASKS

- lightweight and comfortable
- size 17x9 cm (adult) or 12.5x9.3 cm (pediatric)
- conformable nose band for anatomical fitting
- fiber glass free, filtration efficiency of BFE +99% at 1.0 micron
- antifog, latex free
- suitable for hospital, dental and outpatient use
- with lacets or ear loops
- EN 14683 conform

code	99% FILTERING, 3 PLY MASKS box of 1,000 (20 dispensers of 50 pcs.)
25653	Adult 3 ply masks - ear loop - green
25658	Adult 3 ply masks - ear loop - light blue
25673	Adult 3 ply masks - ear loop - pink
25657	Adult 3 ply masks - lacets - green
25674	Pediatric 3 ply masks - ear loop - white
Box of 50 pcs.	
25543	Adult 3 ply masks - ear loop - green



99% FILTERING MASKS MADE IN ITALY - EN 14683:2005



- **25648 MASKELLA** - face mask with ear loops - light blue
- 3 non-allergenic woven-non woven layers
- size 90x180 mm
- weight 3 g
- tensile strength extra-long ties: 80 cm
- comfortable, shapeable nose clip
- filtering efficiency > 99%
- resistance to breath (MM H₂O/cm²) < 2
- does not contain glass fibres
- does not contain latex
- non sterile

min. order: 18 packs of 50=900



- **25649 MASKERITA** - surgical face mask
- 3 non-allergenic woven-non woven layers
- size 90x180 mm
- weight 3 g
- tensile strength extra-long lacets: 80 cm
- comfortable, shapeable nose clip
- filtering efficiency > 99%
- resistance to breath (MM H₂O/cm²) < 2
- does not contain glass fibres
- does not contain latex
- non sterile

min. order: 12 packs of 50=600



- **25652 MASKOP** - ear loop - green
- **25654 MASKOP** - lacets - light blue
- Surgical masks with wrap-around visor**
- anti-misting, antistatic wrap-around visor
- 4 non-allergenic woven-non woven layers
- weight 10.5 g
- atraumatic and conformable nose-clip
- filtering efficiency > 99%
- resistance to respiratory flow (MM H₂O/cm²) < 2.5
- latex and glass fibres free. Non sterile
- fluid permeability: impermeable
- external/internal polyethylene anti-misting strip

min. order: box of 50

2 PLY MASKS

3 PLY MASKS 95%

MOULDED MASKS



- **25651 2 PLY MASKS** - light blue
- box of 2,000 pcs. (40 dispensers of 50 pcs)
- made in soft TNT
- size 17x9 cm with ear loops
- comfortable nose band
- antifog, latex free
- EN 14683 conform



- **25650 3 PLY MASKS** - green
- box of 1,000 pcs. (20 dispensers of 50 pcs)
- 95% filtering mask
- lightweight and comfortable for soft skin
- size 17x9 cm with ear loops
- conformable nose band for anatomical fitting
- fiber glass free, filtration efficiency of BFE +95% at 1.0 micron
- antifog, latex free
- EN 14683 conform

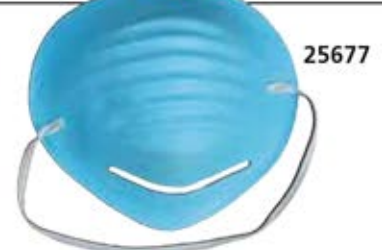

- **25677 MOULDED CONE MASKS** - light blue
- dispenser of 50 pcs.
- splash repellent barrier
- flared edge prevents irritation
- soft, flexible, aluminum nosepiece adjusts for custom fit
- soft, odourless, fiberglass free
- high breathability
- non woven fabric

FOLD-FLAT RESPIRATORS FFP1, FFP2, FFP3



Facial filtering respirators to protect against solid (non-oil) and liquid (oil) volatile particles. With exhalation Valve (excluding 25665). Double elastic with buttonhole allows to hang the mask to the neck when it's not worn. Aluminium adjustable nose piece welded with high resistance and internal Polyethylene (PE) Foam nose pad. Single packed guarantees total hygiene and easy maintenance.

The shape of the respirator has been developed to reduce difficulties of respiration and to improve efficiency in the dialogue. Innovative design allows a perfect view. Wide adaptability to various face contours. Wide filtering area to allow proper ventilation. Light weight.

Conforms to CE standard - EN 149: 2001 + A1: 2009

code	PARTICULATE FOLDABLE RESPIRATORS	Minimum order
25666	Particulate respirator - FFP1 - with valve	box of 20
25665	Particulate respirator - FFP2	box of 20
25670	Particulate respirator - FFP2 - with valve	box of 10
25671	Particulate respirator - FFP3 - with valve	box of 10

NORMS: CEI EN 149: 2001 + A1: 2009
AC 538100 05-06-2008

TECHNICAL SPECIFICATIONS

	25666	25665	25670	25671
Protection:	FFP1	FFP2	FFP2	FFP3
Minimum filter efficiency	78%	92%	92%	98%
Exposure limit fine particles up to	4xTLV	12xTLV	12xTLV	50xTLV
Valve	yes	no	yes	yes
Vertically foldable	yes	yes	yes	yes

MATERIALS

Filter: Polypropylene Fabric
Valve: rigid plastic (excluding 25665)
Valve Membrane: Synthetic Rubber (excluding 25665)
Nose Piece: Polypropylene coated steel adjustable
Elastics: latex-free
Nose Pad: Polyurethane (PU) Foam

3M™ EARLOOP MASK 1826

• 25545 3M™ STANDARD EARLOOP MASK 1826 - box of 50 Surgical 3 ply flat earloop face mask for patient protection. Three plies: 2 external woven non woven and 1 internal with high filtering capacity. It has filtering power > 98% and is classified type II product, compliant with UNI EN 14683:2006.



CONE MASKS FFP2, FFP3 WITH VALVE

- 26006 CONICAL FFP2 MASK WITH VALVE - box of 10
- 26007 CONICAL FFP3 MASK WITH VALVE - box of 5

Conical disposable filtering face mask with exhalation valve, for protection against particles and solid or liquid aerosol. Adjustable nose piece and elastic head band. Exhalation valve reduces the accumulation of humidity and heat.
Norms: EN 149:2001 + A1:2009.
High protection: 94% (FFP2), 99% (FFP3)



IMPERMEABLE, ABSORBENT, ANTI-SLIP MAT FOR FLOORS

IMPERMEABLE ANTI-SLIP ABSORBENT BLUE COLOUR MAT FOR FLOORS

Pre-cut or roll mats to be positioned on the floor of the operating room or near the sink in the pre-operating theatre for holding liquids that could fall on the floor. Mats have high absorbent capacity and optimal speed absorbency. The mats distribute the absorbed liquid by capillary method and maintain it at his internal structure avoiding the lifts on

surface. The special film at rear side blocks the mat on the floor and keeps it stopped without using adhesive matters, which could release glue traces on the floor. They are perfectly adherent at the ground, avoiding risk of accidents.

Absorbent rolls

They have 3 different absorbencies. Can be cut at desired size.

Trolley for rolls

Made in stainless steel with 4 pivoting wheels (2 with brake). Turning base, for rolls with height up to 1 m.



code	ABSORBENT PRE-CUT MATS		Minimum order
	Size	Absorbence	
25150	90x90 cm	1,700 ml/m ²	box of 70
25151	90x120 cm	1,700 ml/m ²	box of 50
25152	90x150 cm	1,700 ml/m ²	box of 40
25153	90x200 cm	1,700 ml/m ²	box of 30
25154	90x250 cm	1,700 ml/m ²	box of 20
ABSORBENT ROLLS			
25165	90 cm x 50 m	1,700 ml/m ²	1
25166	90 cm x 50 m	2,500 ml/m ²	1
25167	90 cm x 50 m	3,500 ml/m ²	1
TROLLEY FOR ROLLS			
25169	Trolley for absorbent rolls		1

VINYL GLOVES

Elasticized for extra sensitivity and optimal grip. Powder free, ideal for sensitive skins.



Pre-powdered



25701

VINYL GLOVES



25692

POWDER FREE VINYL GLOVES

Powder free, ideal for sensitive skin

EXTRA SOFT POWDER FREE VINYL GLOVES

VINYL GLOVES:

Sensitivity and protection. Gloves made in polyvinyl chloride, latex-free. Ideal gloves for everyday use, they ensure protection and sensitivity. Suitable in hospital, ambulatory and for dressing. Suitable also for laboratory use. Packed in dispenser box of 100 units. MD class I. PPE cat III. EN455-EN374-AQL<1.5

Powder free elasticized	Powder free	Pre powdered	VINYL GLOVES - NON STERILE (box of 100)
25716	25692	25701	Small size - NON sterile
25717	25693	25702	Medium size - NON sterile
25718	25694	25703	Large size - NON sterile

LATEX GLOVES

Pre-powdered



25706

PURE LATEX GLOVES

Powder free, ideal for sensitive skin



25711

POWDER FREE LATEX GLOVES

Extra long: 400 mm for extra protection of operator



25691

EXTRA LONG POWDER FREE LATEX GLOVES

LATEX GLOVES - ambidextrous - with hem

Pure latex gloves non sterile. Sensible and resistant, ensure optimal grip and protection. Suitable in hospital, ambulatory and for dressing. Suitable also for laboratory use. Packed in dispenser of 100 (dispenser of 50 for extra long gloves). Medical device Class I. PPE cat III. EN455-EN374-AQL<1.5

Pre powdered	Powder free	LATEX GLOVES NON STERILE (box of 100)
25706	25711	Small size - NON sterile
25707	25712	Medium size - NON sterile
25708	25713	Large size - NON sterile
25408	25410	Extra large size - NON sterile
Pre powdered	Powder free	LATEX GLOVES EXTRA LONG NON STERILE (box of 50)
-	25691	Medium extra long size 400 mm

LATEX SURGICAL GLOVES - STERILE

STERILE SURGICAL GLOVES



Pre-powdered

25685

POWDER FREE STERILE SURGICAL GLOVES

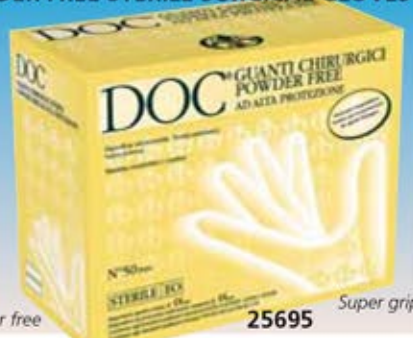

Powder free

25695

Super grip

LATEX STERILE SURGICAL GLOVES

The micro textured surface assures a very good grip in any different condition of use. High protection and anatomic shape assure a very good comfort. Sterilized by ETO. Length 300 mm. Conform to USP: international pharmacopoeia. Packed in dispenser of 50 pairs. MD Class II A. PPE cat III. EN455-EN 374-AQL<1.5

Pre powdered	Powder free	LATEX SURGICAL GLOVES STERILE - box of 50 pairs
25685	25695	Size 6.5 - sterile
25686	25696	Size 7 - sterile
25687	25697	Size 7.5 - sterile
25688	25698	Size 8 - sterile
25689	25699	Size 8.5 - sterile

LATEX - EXTRA LIGHT



PRO EXTRA LIGHT LATEX GLOVES - ambidextrous

Disposable sensitive pure latex gloves non sterile. Suitable for personal protection. AQL <1.5

code	LATEX GLOVES - box of 100
25420	Small size - non sterile
25421	Medium size - non sterile
25422	Large size - non sterile

NITRILE GLOVES - POWDER FREE

Superior protection



25681



25683



25415

NITRILE GLOVES

Disposable nitrile examination gloves, powder free and latex free, extremely sensitive and resistant. The micro textured surface ensures an optimal grip. Suitable for use in hospital. Packed in dispenser of 100. Medical device Class I. PPE (Personal Protective Equipment) cat III. EN455-EN374-AQL<1.5

Standard regular blue 4.9 g*	Veloforte ice blue 3.5 g*	Zero regular blue 3 g*	NITRILE GLOVES NON STERILE (box of 100)	
25680	25679	25415	Small - non sterile	CE
25681	25683	25416	Medium - non sterile	
25682	25684	25417	Large - non sterile	
-	-	25418	Extra large - non sterile	

*Weight for single glove - medium size

NITRILE EXTRA LONG - 400 mm

• 25405 NITRILE GLOVES - extra long - blue
Disposable nitrile examination gloves powder-free and latex free. The micro textured surface assures a very good grip. Suitable in hospital. The 400 mm length and resistance offer high level of protection. Packed in dispenser of 50. Non sterile. Medical device Class I. PPE cat III. EN455-EN374-AQL<1.5

25405



COPOLYMER GLOVES

COPOLYMER GLOVES ON PAPER

Examination gloves, elasticized, medium size, for gynaecological use. MD class 1.

• 25714 COPOLYMER GLOVES - non sterile
minimum order: 10 packs of 100 pieces = 1,000 pcs.

25714

• 25709 COPOLYMER GLOVES - sterile

Sterilized by ETO. AQL <1.5
Individually packed.

minimum order: pack of 100 pieces



25709



GLOVES DISPENSER



Dimension:
257x100xh 134 mm

Weight: 322 g

• 25430 GLOVES DISPENSER

Holds a standard box of 100 gloves. It is made of unbreakable washable thermoplastic material. It can be easily hung to the wall (screw not included) and into ambulances in a vertical or horizontal position. It is made of two parts: the base, which is fixed and the cover, which can be easily removed once the box of gloves needs to be replaced.

NITRILE LONG - 300 mm

- 25396 NITRILE GLOVES - small - regular blue - box of 100
- 25397 NITRILE GLOVES - medium - regular blue - box of 100
- 25398 NITRILE GLOVES - large - regular blue - box of 100

Disposable nitrile examination gloves powder-free and latex-free. The 300 mm length and 5.7 g

weight ensure a high level of protection. The micro textured surface ensures a very good grip.

Suitable for use in hospital. Medical device. Class I - EN455.

PPE (Personal Protection Equipment) Cat III.

EN420, EN374, EN388 AQL<1.5



25396

Non sterile

COTTON GLOVES

White	Size	Length cm		Weight g		Minimum order
		min	max	min	max	
25864	Size 6.5	20	22	18	20	box of 10 pairs
25865	Size 7	21	23	19	21	box of 10 pairs
25866	Size 7.5	23	25	21	23	box of 10 pairs
25867	Size 8	24	26	23	25	box of 10 pairs
25868	Size 8.5	25	27	25	27	box of 10 pairs
25870	Mixed sizes					box of 10' pairs

*1x size 6.5 and 8.5, 2x size 7 and 8, 4x size 7.5



6.5 cm extra long cuff

DRACULA



• 25700 DRACULA

Universal holder for gloves and tissue boxes, with little sharp teeth which automatically adjust to tightly hold any size of box. It's a universal holder that allows one-hand operation.

For minimum 500 pcs we can put your logo here

LATEX FINGER COTS

• 25941 LATEX FINGER COTS - medium

• 25942 LATEX FINGER COTS - large

Latex finger cots to cover 1 finger.

Non sterile, single use, for finger protection, with talc.

minimum order: 1.000 pcs. (10 bags of 100 pcs.)



NON WOVEN SURGICAL SPECIALISTIC GOWNS - STERILE

SURGICAL SPECIALISTIC GOWNS

Specialistic, water repellent, breathable gowns for a barrier effect to fluids and bacteria

- cotton cuffs 8 cm
- ultrasonic welding
- neck velcro closure
- 4 waist straps for internal and external closure

Pre folded

For easy programmed dressing

Welded reinforcement (only 21015, 21016)

Water-proof, breathable reinforcement on front and on sleeves ultrasonic welded.

All gowns include two dry-paper towels. Conforms to UNI EN ISO 13795. Made in Italy.



21020-21023

HIGH QUALITY
50 g/m²

code	SURGICAL GOWNS STERILE	Minimum order
SURGICAL GOWNS 35 g		
21010	Size M - length 115 cm	box 30
21011	Size L - length 130 cm	box 30
21012	Size XL - length 135 cm	box 30
SURGICAL GOWNS 50 g		
21020	Size M - length 120 cm	box 30
21021	Size L - length 130 cm	box 30
21022	Size XL - length 140 cm	box 30
21023	Size XXL - length 150 cm	box 30
REINFORCED GOWNS 35 g		
21015	Size L - length 130 cm	box 30
21016	Size XL - length 135 cm	box 30



DISPOSABLE GOWNS

DISPOSABLE SURGICAL GOWNS - green

Disposable non-woven gowns, suitable when comfort and light protection are required.

Colour: green

Grams: 25 g/m²

One size: 110x136 cm

With cotton cuffs (26100 only).

26100



code	NON WOVEN GOWNS	Minimum order
26099	Disposable Gowns - sterile*	box of 50
26100	Disposable Gowns - non sterile	bag of 10

*Sterilized by ETO

POLYTHENE GOWNS

DISPOSABLE POLYTHENE GOWNS - green

Surgical polythene gowns with neck and waist laces and cotton cuff.

Made in waterproof non-woven fabric.

One size 115x140 cm

Available sterile or non sterile.

Made in Italy.



code	POLYTHENE GOWNS	Minimum order
26092	Poly Gowns - sterile	box of 50
26093	Poly Gowns - non sterile	box of 100

NON-WOVEN UNIFORM, JACKET AND PANTS

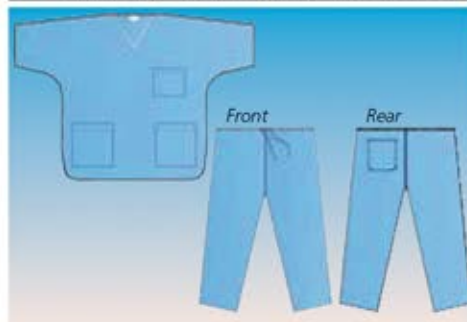

- 26076 UNIFORM COAT+PANT - S
- 26077 UNIFORM COAT+PANT - M
- 26078 UNIFORM COAT+PANT - L
- 26079 UNIFORM COAT+PANT - XL

minimum order: box of 50 - non sterile

Short sleeve jacket "V" neck, with 3 pockets.

Pants with rear pocket, closure by laces.

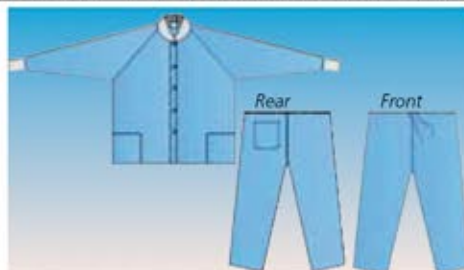

- 26023 JACKET WITH BUTTON - L
- 26024 JACKET WITH BUTTON - XL
- 26027 JACKET AND PANTS - L
- 26028 JACKET AND PANTS - XL

minimum order: box of 50 - non sterile

Jacket long sleeve, neck and cuffs made of elastic polyester. Front opening with snap buttons. 2 front pockets.

Pants with laces and rear pocket.

COLONOSCOPY PANTS



- 21030 COLONOSCOPY PANTS

minimum order: box of 50 - non sterile

Colonscopy pants, fit all sizes, length 110 cm.

Elastic waist, rear opening with velcro fixing.

Made in water-repellent non-woven SMS 50g/m².

DISPOSABLE KITS FOR PATIENT/VISITOR DRESSING - NON STERILE

- 26017

KIMONO - blue

- box of 100

Opaque non-woven SMS kimono 40 g/m² with short-sleeves. Front opening and closing at the waist with laces.

One size: length 115 cm, width 140 cm.



- 26018 PATIENT DRESSING KIT - box of 25

Kit includes kimono, round cap with elastic band and shoe-covers.



- 26019 VISITOR DRESSING KIT - box of 25

Kit includes gown for visitor, round cap with elastic band, three layers mask with ear loops, polyethylene shoe-covers.

C-FOLD AND V-FOLD HAND TOWELS



25200

• **25200 C-FOLD HAND TOWELS** - pack of 150 pcs.
Pure cellulose, 1 ply. Size 23x33 (folded 23x11 cm).
minimum order: box of 24 packs

• **25205 DISPENSER**
For C and V fold hand towels



25205



25202

• **25202 V-FOLD HAND TOWELS** - 2 plies - pack of 160 pcs.
minimum order: 3,200 (20 packs of 160)
Pure wadding of cellulose, 2 plies (36 g/m²: 2x18 g/m²).
Size: 25x22.6 cm (folded 25x11.3 cm)

ABSORBENT NON WOVEN WIPES



Non woven absorbent wipes for sanitary, health and hygienic use. Made of wood pulp, PES, spunbonded PP.

code	ABSORBENT NON WOVEN WIPES			Minimum order
	Model	Size cm	Weight g	
25221	Smooth	30x40	45-50	1.400 pcs**
25222	Smooth - folded	30x40	45-50	1.400 pcs***
25223	Microembossed - folded	20x40	45-50	1.400 pcs***

*Size accuracy: ±5% **14 boxes of 100 ***28 boxes of 50

HAND TOWEL ROLLS



25210

• **25210 HAND TOWEL ROLLS**
Pure cellulose, 2 plies (36 g/m²).
Size 23x24 cm.
N. of sheets: 252.
minimum order: box of 12 rolls
• **25215 DISPENSER**
For hand towel rolls









25215

FOLDED NAPKINS

FOLDED NAPKINS

Pre-coated folded napkins, made of 2 plies of pure cellulose wadding laminated with 1 ply of polyethylene, or 1 ply of pure cellulose wadding laminated with 1 ply of polyethylene. The special features of materials offer high absorbency and waterproofness to assure high comfort to the patient.

code	FOLDED NAPKINS - pack of 500 pcs		
	Napkins 2+1 (2 plies cellulose + 1 ply polyethylene)		
25230	Napkins 33x45 cm	- green	
25231	Napkins 33x45 cm	- light blue	
25232	Napkins 33x45 cm	- pink	
25233	Napkins 33x45 cm	- white	
Napkins 1+1 (1 ply cellulose + 1 ply polyethylene)			
25226	Napkins 33x45 cm	- blue	
25227	Napkins 33x45 cm	- lilac	
25228	Napkins 33x45 cm	- orange	
25240	Plastic dispenser		
25239	Chain for napkins		



BOUFFANT, SURGEON CAP

• **25675 BOUFFANT CAP** - light blue
Minimum order: 1,000 pcs (10 bags of 100 pcs)
- made of light weight PPSB
- breathable, soft, comfortable
- elastic headband
- medium size 21"



25675



25678

• **25678 SURGEON CAP** - green
• **25655 SURGEON CAP** - light blue
Minimum order: 1,000 pcs (10 bags of 100 pcs)

SHOE COVERS

• **25690 SHOE COVERS** - light blue - box of 100

• **25676 SHOE COVERS** - light blue
Carton of 2,000 pcs (20 bags of 100 pcs)
- made of PPSB, breathable
- comfortable
- with elastic band



25676

BIBS

• **25672 BIBS** - roll of 80 - 50x60 cm

Made of 2 plies, one of highly absorbent cellulose tissue and one of waterproof polyethylene. Extremely soft and comfortable, they assure an excellent protection to the patient. Each roll has 80 bibs with pre-cut and comfortable ribbons or bi-adhesive.

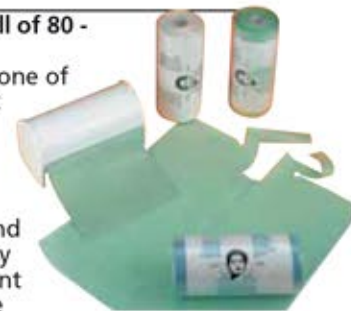

Minimum order: box of 6 rolls

DOCTOR'S WHITE AND SURGICAL COATS, JACKETS, TROUSERS



100% COTTON COATS, TROUSERS AND JACKETS

Professional and stylish line with all sizes for men and women, made in high quality 100% cotton. Doctor's white coats have 2 side

pockets, 1 breast pocket and half belt. Woman and man models have buttons, unisex model has press studs and elasticated cuffs.

THEATRE GOWNS - GREEN	
Size	Man-woman
52-56	26162
58-62	26163

See disposable gowns, coats, pants, jackets at page 21.

DOCTOR'S WHITE COATS 100% COTTON					
Size			Woman	Man	Unisex
Europe	USA	France	with button	with button	with press stud
40	XS	36	26110	-	26080
42	S	38	26111	-	26081
44	S	40	26112	26098	26082
46	M	42	26113	26101	26083
48	M	44	26114	26102	26084
50	L	46	26115	26103	26085
52	L	48	26116	26104	26086
54	XL	50	26117	26105	26087
56	XL	52	-	26106	26088
58	XXL	54	-	26107	26089

JACKETS				
Size	White	Green	Light Blue	Fantasy
XS	26124	26126	26128	-
S	26130	26140	26150	26170
M	26131	26141	26151	26171
L	26132	26142	26152	26172
XL	26133	26143	26153	26173
XXL	26134	26144	26154	-

TROUSERS				
Size	White	Green	Light Blue	Fantasy
XS	26125	26127	26129	-
S	26135	26145	26155	-
M	26136	26146	26156	-
L	26137	26147	26157	-
XL	26138	26148	26158	-
XXL	26139	26149	26159	-

60% COTTON - 40% POLYESTER COATS, TROUSERS AND JACKETS

Professional and stylish line with all sizes for men and women, made in 60% high quality cotton and 40% polyester.

Man and woman model (weight 190 g) have buttons, unisex model (weight 170 g) has hidden press studs and elasticated cuffs. White jackets 190 g, coloured jacket 170 g.

Doctor's white coats have 2 side pockets and 1 breast pocket.

DOCTOR'S WHITE COATS 60% COTTON - 40% POLYESTER					
Size			Woman	Man	Unisex
Europe	USA	France	with button	with button	with press stud
38-40	XS	36	21401	-	21421
42-44	S	38-40	21402	21412	21422
46-48	M	42-44	21403	21413	21423
50-52	L	46-48	21404	21414	21424
54-56	XL	50-52	21405	21415	21425
58-60	XXL	54-56	-	21416	21426
62-64	XXXL	58-60	-	21417	21427

TECHNICAL SPECIFICATIONS	
Composition:	60% cotton - 40% polyester
Weight:	200 g/m ²
Yarn count - warp:	Ne 20 ± 2
Yarn count - weft:	Ne 16 ± 2
Construction - warp:	42 ± 3
Construction - weft:	19 ± 3
Breaking strength - warp:	98 kg -5%
Breaking strength - weft:	39 kg -5%
Fastness to washing:	4
Treatments and finishing:	crease resist
Dimensional stability - washing at 90°C:	3%

JACKETS 60% COTTON - 40% POLYESTER				
Size	White	Green	Light Blue	Any colour*
XS	21431	21441	21451	21471
S	21432	21442	21452	21472
M	21433	21443	21453	21473
L	21434	21444	21454	21474
XL	21435	21445	21455	21475
XXL	21436	21446	21456	21476
XXXL	21437	-	21457	21477

TROUSERS				
Size	White	Green	Light Blue	Any colour*
XS	21491	21501	21511	21551
S	21492	21502	21512	21552
M	21493	21503	21513	21553
L	21494	21504	21514	21554
XL	21495	21505	21515	21555
XXL	21496	21506	21516	21556
XXXL	21497	-	21517	21557



*Available in 60 days. Specify size and colour with order. Minimum order 100 mixed pieces same colour.

• 21398 EMBROIDERY ON COTTON-POLYESTER COATS/JACKETS ONLY

Possibility of 1 or 2 colour logo, size 8-10 cm x 2-3 cm on coats and jackets.

JACKETS WITH PRESS STUD AND TROUSERS



JACKETS AND TROUSERS

JACKET WITH STUD AND TROUSERS

Made in pure cotton 60% and polyester 40%.
Jackets are offered in white colour or in 3 different colours.
Other 20 colours available in 60 days.

TECHNICAL SPECIFICATIONS	
Composition:	60% cotton - 40% polyester
Weight:	200 g/m ²
Yarn count - warp:	Ne 20 ± 2
Yarn count - weft:	Ne 16 ± 2
Construction - warp:	42 ± 3
Construction - weft:	19 ± 3
Breaking strenght - warp:	98 kg -5%
Breaking strenght - weft:	39 kg -5%
Fastness to washing:	4
Treatments and finishing:	crease resist
Dimensional stability - washing at 90°C:	3%

JACKETS WITH PRESSURE STUD							
Size	Woman			Unisex			
	White	Violet	Colour on request	White	Blue navy	Light blue	Colour on request*
XS	21561	21571	21591	21601	21611	21621	21651
S	21562	21572	21592	21602	21612	21622	21652
M	21563	21573	21593	21603	21613	21623	21653
L	21564	21574	21594	21604	21614	21624	21654
XL	21565	21575	21595	21605	21615	21625	21655
XXL	21566	21576	21596	21606	21616	21626	21656

TROUSERS - UNISEX						
Size	White	Violet	Blue	Light blue	Colour on request*	
XS	21491	21521	21531	21511	21551	
S	21492	21522	21532	21512	21552	
M	21493	21523	21533	21513	21553	
L	21494	21524	21534	21514	21554	
XL	21495	21525	21535	21515	21555	
XXL	21496	21526	21536	21516	21556	
XXXL	21497	-	-	21517	21557	

20 COLOURS ON REQUEST*

Tan	Coco beige	Empire red	Virtual grey
Vert anis	Artic green	Verbena	Kelly green
Aqua	Prissy pink	Iride	Smokeberry
Menthe	Doe	Yellow	Sun orange
RC blue	Magic azur	New azur	NYCO khaki

*Available in 60 days. Specify size and colour with order.
Minimum order 100 mixed pieces same colour.



Short sleeves

Five hidden press studs

Two pockets and 1 breast pocket

Trousers with 2 front pockets and 1 on back

Half belt on back

Trousers with elasticated waist

SURGICAL CAPS

100% cotton surgical cap with fantasy pictures or green.

- 26166 GREEN CAP
- 26165 FANTASY CAP - light blue
- 26167 FANTASY CAP - beige
- 26168 FANTASY CAP - red

Other colour on request. Minimum order 1,000 pieces.



DENTAL JACKETS

DENTAL JACKETS

DENTAL JACKETS

Short sleeves round-necked jacket with 2 buttons on right shoulder and 5 hidden buttons.
One pocket and one breast pocket.
Green colour 100% pure cotton.



DENTAL JACKET	
Size	Unisex green
XS	21000
S	21001
M	21002
L	21003
XL	21004
XXL	21005

PROFESSIONAL ULTRALIGHT SHOES



200 g ONLY

GIMA ULTRA LIGHT SHOES

Protective shoes meeting requirements of working shoes norms EN ISO 20347: A E SRC

- **extremely light:** only 200 g per pair
- **aerated:** lateral holes provide aeration but avoid liquid dropping in
- **anatomic:** respect natural foot anatomy
- **antishock:** maximum energy absorption in the heel zone
- **antislip:** the unique design of the sole's tread meet the SRC requirements regarding the slipping resistance
- **antistatic:** antistatic non marking element in the heel zone working even after many washings
- **washable up to 50°C:** with normal neutral detergents, resistant to chemicals or UV sterilizations used in hospitals
- **antibacterial, antimould, antifungus**



ULTRA LIGHT SHOES		
Size	White	Blue
34	20000	20020
35	20001	20021
36	20002	20022
37	20003	20023
38	20004	20024
39	20005	20025
40	20006	20026
41	20007	20027
42	20008	20028
43	20009	20029
44	20010	20030
45	20011	20031
46	20012	20032
47	20013	20033

ANTISTATIC CLOGS - AUTOCLAVABLE AT 134°C



GIMA PROFESSIONAL CLOGS

- active arch support to stimulate circulation
 - antistatic material directly injected in the polymeric blend
 - perforated sole for breathability and transpiration
 - antislip grooved sole safe on wet floor
 - machine washable, sterilizable at 134°C
 - available also with strap for extra security (26471-26482)
 - individually packed in carton box
 - all models (with or without pores, with or without straps) are available in any size or colour (including red).
- Minimum order for products not coded: 100 pairs.
Made in Italy.



26451 - 26462

26231 - 26242

WITH MOVABLE STRAP WITH OR WITHOUT PORES

EN ISO 20347 A-E

AVAILABLE IN OTHER COLOURS/SIZES (minimum order 100 pairs)

Size	UPPER WITHOUT PORES						UPPER WITH PORES				
	White	Green	Electric Blue	Orange	Fuchsia	White with strap	White	Yellow	Blue	Violet with strap	Green with strap
34-35	26311	26331	26351	26371	-	26231	26411	-	26451	-	26471
35-36	26312	26332	26352	26372	-	26232	26412	-	26452	-	26472
36-37	26313	26333	26353	26373	-	26233	26413	-	26453	-	26473
37-38	26314	26334	26354	26374	26394	26234	26414	26434	26454	26254	26474
38-39	26315	26335	26355	26375	-	26235	26415	-	26455	26255	26475
39-40	26316	26336	26356	26376	-	26236	26416	-	26456	26256	26476
40-41	26317	26337	26357	26377	-	26237	26417	-	26457	26257	26477
41-42	26318	26338	26358	26378	26398	26238	26418	26438	26458	26258	26478
42-43	26319	26339	26359	26379	26399	26239	26419	26439	26459	26259	26479
43-44	26320	26340	26360	26380	26400	26240	26420	26440	26460	26260	26480
45-46	26321	26341	26361	26381	-	26241	26421	-	26461	-	26481
47-48	26322	26342	26362	26382	-	26242	26422	-	26462	-	26482



ULTRA LIGHT CLOGS WITH STRAP

200 g ONLY



GIMA ULTRA LIGHT CLOGS

Protective clogs meeting requirements of working shoes norms EN ISO 20347 A E SRC

- **extremely light:** only 200 g per pair
 - **aerated:** lateral holes provide aeration but avoid liquid dropping in
 - **anatomic:** respect natural foot anatomy
 - **antishock:** maximum energy absorption in the heel zone
 - **antislip:** the unique design of the sole's tread meet the SRC requirements regarding the slipping resistance
 - **antistatic:** antistatic non marking element in the heel zone working even after many washing
 - **washable up to 50°C:** with normal neutral detergents, resistant to chemicals or UV sterilizations
 - **antibacterial, antimould, antifungus**
- 26206 ULTRA LIGHT CLOGS - other colour - minimum 50 pair (available in light blue, orange, black, fuchsia)

ULTRA LIGHT CLOGS

Size	White	Blue	Green
34	26190	26210	26175
35	26191	26211	26176
36	26192	26212	26177
37	26193	26213	26178
38	26194	26214	26179
39	26195	26215	26180
40	26196	26216	26181
41	26197	26217	26182
42	26198	26218	26183
43	26199	26219	26184
44	26200	26220	26185
45	26201	26221	26186
46	26202	26222	26187
47	26203	26223	26188

SILICONE NURSE WATCHES



NURSE WATCHES
Silicone nurse watches, provided with a safety pin.
Suitable to measure patient pulse, beat and sterilization procedure timing.
Conforming to procedures not allowing nurses to wear wrist watches.
Japan movement, watch case 35 mm, watch length 85 mm.
Shelf life of battery: 18 months from the day of first use.
Manual: GB, FR, IT, ES, PT, DE, GR, PL, Arab



SILICONE WATCHES		GIMA code	SILICONE WATCHES
code	Round - single colour		Round - single colour with aluminium box
20400	White	20410	White
20401	Blue	20411	Blue
20402	Red		Squared - single colour with aluminium box
20403	Purple	20455	Blue
20404	Pink		
20405	Black		
Round - fantasy		Squared - fantasy	
20420	Red & white	20460	Violet and sky blue
20421	Colour fantasy	20461	Hearts
20422	Zebra	20462	Flowers
20423	Bubbles	20463	Leopard
20424	Leaves	20464	Roses
20425	Caterpillar	20465	Foot print
Silicone straps - spare		Digital**	
20418	Kit of 6 silicone straps*	20480	Blue

*Spare silicone straps for round watches

**Manual: GB, FR, IT, ES



NURSE STAINLESS STEEL SCISSORS AND FORCEPS



20513 20500 20512

Nurse bandage scissors - 14 cm



20542 20551 20552

Straight artery forceps - 16 cm



20521 20529 20520

Straight scissors blunt/sharp - 14 cm

Model	BANDAGE* SCISSORS - 14 cm	STRAIGHT* SCISSORS - 14 cm	ARTERY* FORCEPS - 16 cm
Standard	34129	26725	26717
Standard with belt clip	20500	20520	-
Green ring	20501	20521	20541
Lilac ring	20502	20522	20542
Foot print	20509	20529	20549
Leopard	20511	20531	20551
Bubbles	20512	20532	20552
Hearts	20513	20533	20553

*Those powder coated instruments are not autoclavable, can be sterilized in water at maximum 110°C

STAINLESS STEEL UTILITY AND BANDAGES SCISSORS



20581 20582 20573 20574 20560

Plastic coloured finger-contour handles for maximum comfort.

All purpose, first aid scissors, easily cut bandages, leather and plaster casts. Autoclavable at 136°C. Instructions: GB, FR, IT, ES, PT, DE.

UTILITY SCISSORS - box of 10			
12 cm - 4.7"	16.5 cm - 6.5"	19 cm - 7.5"	Colour
20560	20570	20580	Black
-	20571	20581	Blue
-	20572	20582	Red
-	20573	20583	Purple
-	20574	20584	Pink
20590	Steel chain for scissors and forceps		



BI-LAYER NON-WOVEN FABRIC STERILE SURGICAL DRAPES

DRAPES

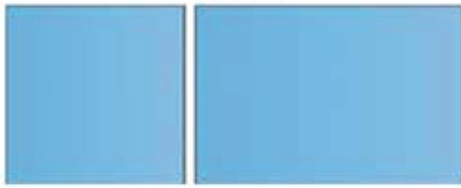

All surgical drapes are made in light-blue bi-layer water-proof non-woven fabric 54 g/m². Individually packed in PE bag, sterile (Ethylene oxide), latex free

DRAPES WITH ADHESIVE SIDE



DRAPES WITH CENTRAL ADHESIVE HOLE

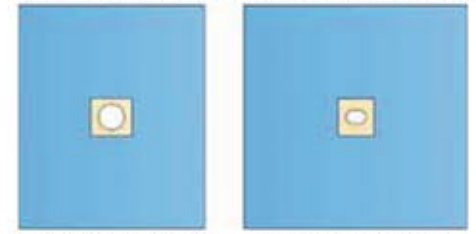

Drape with hole Ø 10 cm

Drape with hole 6x9 cm

code	DRAPES	Minimum order
23600	Drape 50x50	box of 100
23601	Drape 50x75	box of 100
23602	Drape 75x90	box of 75
23604	Drape 100x100	box of 50
23606	Drape 120x150	box of 50
23608	Drape 150x200	box of 25

GIMA code	DRAPES WITH ADHESIVE SIDE	Minimum order
23610	Drape 50x50	box of 100
23611	Drape 50x75	box of 100
23612	Drape 75x90	box of 75
23614	Drape 100x100	box of 50
23617	Drape 180x200	box of 25
23618	Drape 150x240	box of 25

code	DRAPES WITH CENTRAL ADHESIVE HOLE	Minimum order
23620	Drape 50x75 - hole 6x9 cm	box of 75
23622	Drape 75x90 - hole 6x9 cm	box of 75
23623	Drape 75x90 - hole Ø 10 cm	box of 75
23624	Drape 100x100 hole Ø 10 cm	box of 50
23625	Drape 100x150 - hole 9x18 cm	box of 25
23626	Drape 120x150 - hole Ø 10 cm	box of 25

NON-WOVEN FABRIC STERILE OPHTHALMIC SURGERY DRAPES

Hole 6x9 cm with incision film. Single bag to receive fluids and adaptable bar.



• 23634 OPHTHALMIC SURGERY DRAPE 80x100 cm - sterile - box of 40

Hole 10x10 cm with incision film. Double bag to receive fluids with adaptable bar.

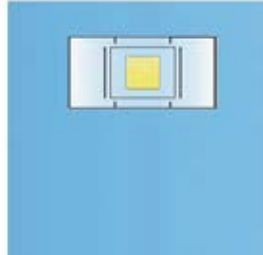

• 23635 OPHTHALMIC SURGERY DRAPE 160x160 cm - sterile - box of 15

Hole Ø11 cm with incision film. Double bag 35x73 cm to receive fluids with adaptable bar and adaptable bar for nasal septum. Wrapped in crepe paper.



• 23636 OPHTHALMIC SURGERY DRAPE 160x260 cm - sterile - box of 10

SURGERY COTTON DRAPES



- 26495 DRAPE 90x150 cm
 - 26496 DRAPE 150x150 cm
 - 26497 DRAPE 250x150 cm
- Made in 100% high quality cotton, green colour.
Made in Europe.

INCISION FILM - STERILE

Its purpose is to define the anatomic part of the patient where the surgery will be done. It is applied at the point where the wound is, to protect it from possible contamination. Incision film made of adhesive polyurethane.

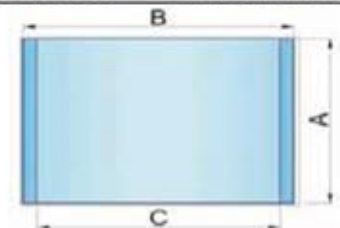

code	SIZE AxB	SIZE AxC	Minimum order
23628	45x50 cm	45x40 cm	box of 10
23630	30x35 cm	30x25 cm	box of 50
23631	45x50 cm	45x40 cm	box of 50
23632	60x65 cm	60x55 cm	box of 50

POLYESTER OR MICROFIBRE SURGERY DRAPES

100% TEXTURIZED POLYESTER DRAPES

Studied for replacing the classic cotton drape in operating rooms.

Advantages:

- it does not have particles release of dust or cotton fibers that could cause infections during surgery
- various usability on the field:
 - as a sheet under the patient
 - as a towel
 - to tamponage, considering its high absorbency
 - as a pre or post surgery cover, thanks to the capability of keeping a good body temperature

Polyester texturized fabric



- 41000 POLYESTER DRAPE 90x150 cm - light blue
- 41001 POLYESTER DRAPE 150x150 cm - light blue
- 41002 POLYESTER DRAPE 250x150 cm - light blue

MICROFIBRE DRAPES

(99% polyester + 1% carbon fibre)

The microfibre line is conceived for operating room.

The characteristics and abilities are various:

- the fabric does not absorb liquids, maintaining the operating field dry;
- the fabric does not have particles release of dust or fibre that could cause infections on the patient.

GIMA fabric is composed of polyester and carbon fibres. The addition of carbon fibres serves as protection from potential electric discharges.

- 41009 MICROFIBRE DRAPE 90x150 cm - green
- 41010 MICROFIBRE DRAPE 150x150 cm - green
- 41011 MICROFIBRE DRAPE 250x150 cm - green

Sizes of drapes may vary ±5% due to fabric processing during production phase

Microfibre fabric



STERILE SURGERY SETS

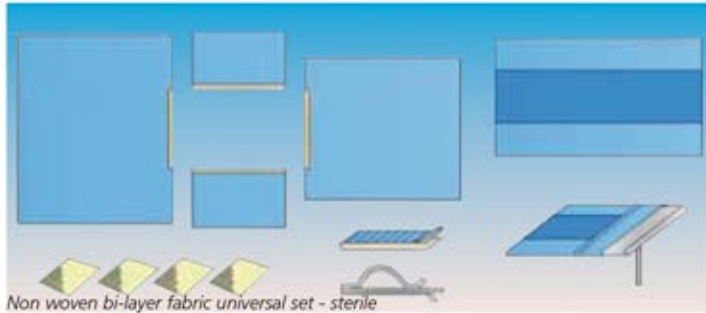

Non woven bi-layer fabric universal set - sterile

• 23640 UNIVERSAL SET - sterile - box of 10

- 1 table cover 150x200 cm with central absorbent band
- 1 Mayo stand cover 80x145 cm
- 1 standard surgical drape, 150x240 cm with adhesive tape
- 1 standard surgical drape, 180x200 cm with adhesive tape
- 2 standard surgical drapes, 75x90 cm with adhesive tape
- 4 towels 35x40 cm
- 1 adhesive strip 10x50 cm
- 1 tube holder 2.5x20 cm

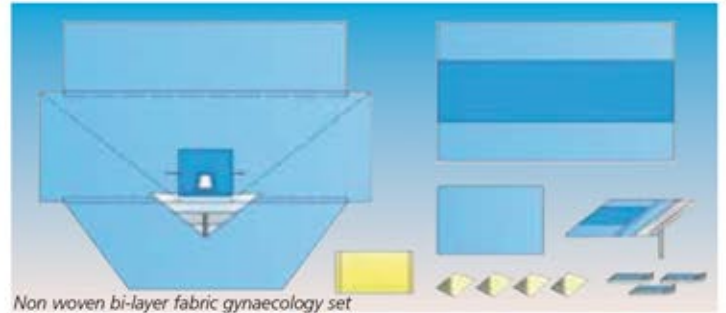

Non woven bi-layer fabric gynaecology set

• 23641 GYNAECOLOGY SET - sterile - box of 8

- 1 table cover 150x200 cm with central absorbent band
- 1 Mayo stand cover 80x145 cm
- 1 gynaecology drape for lithotomy position 290x240 cm with adhesive hole, built-in
- leggings, bag for liquid collection with filter and drain valve
- 1 drape 75x90 cm
- 1 incision film 35x50 cm
- 3 adhesive strips 10x50 cm
- 4 towels 35x40 cm

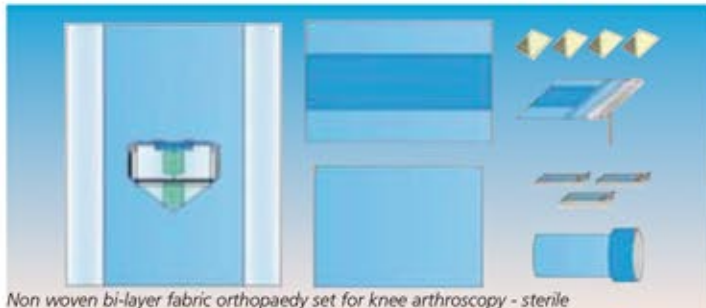

Non woven bi-layer fabric orthopaedy set for knee arthroscopy - sterile

• 23642 SET FOR KNEE ARTHROSCOPY - sterile - box of 8

- 1 table cover 150x200 cm with absorbent central band
- 1 Mayo stand cover 80x145 cm
- 1 standard surgical drape, 150x180 cm
- 1 orthopaedy drape for arthroscopy at knee 230x320 cm with elastic hole and bag for liquid collection
- 1 stockinette 22x75 cm
- 3 adhesive strips 10x50 cm
- 4 towels 35x40 cm

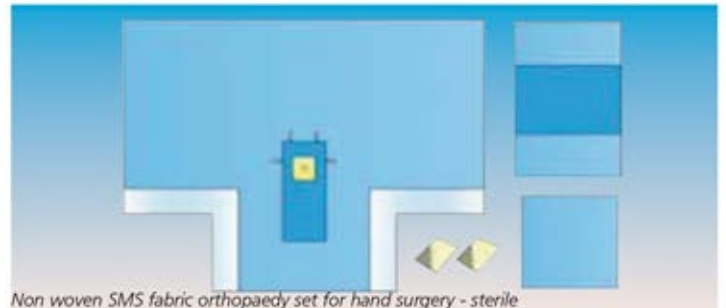

Non woven SMS fabric orthopaedy set for hand surgery - sterile

• 23643 SET FOR HAND SURGERY - sterile - box of 8

- 1 table cover 150x200 cm with central absorbent band
- 1 standard surgical drape, 100x100 cm
- 2 towels 35x40 cm
- 1 T-shape drape for hand surgery 370x190x290 cm with elastic hole 5 cm and cable fixing Velcro strips

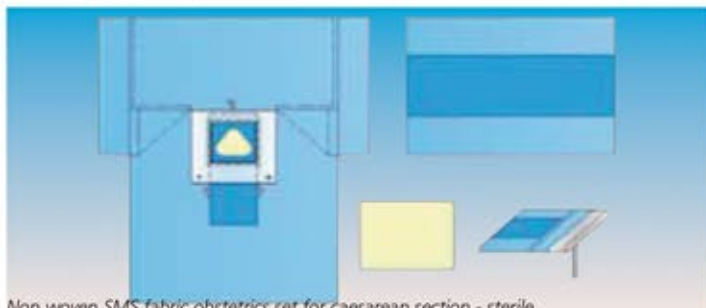

Non woven SMS fabric obstetrics set for caesarean section - sterile

• 23644 SET FOR CESAREAN SECTION - sterile - box of 8

- 1 table cover 150x200 cm with central absorbent band
- 1 Mayo stand cover 80x145 cm
- 1 drape for caesarean section 260x200x310 cm with incision film and bag for liquid collection
- 1 drape "baby blanket" 75x90 cm

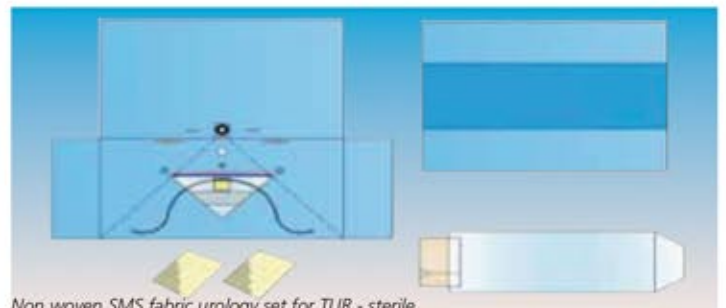

Non woven SMS fabric urology set for TUR - sterile

• 23645 UROLOGY SET FOR TUR - sterile - box of 8

- 1 table cover 150x200 cm with central absorbent band
- 1 urology drape for TUR, 200x280x220 cm with perineal and subpubic holes,
- bag for liquid collection with filter, adhesive tape and straps
- 1 camera drape 13x250 cm
- 2 towels 35x40 cm

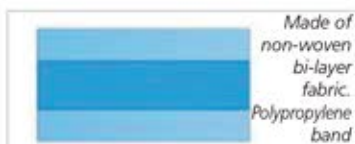

Made of non-woven bi-layer fabric. Polypropylene band

• 23650 Table cover 150x200 cm - sterile - box of 20



• 23651 Mayo stand cover 80x145 cm - sterile - box of 40



• 23654 Adhesive pocket for tools 35x42 cm - box of 100

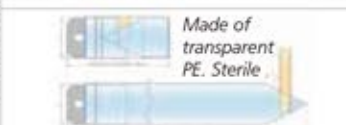

• 23655 Camera drape 13x250 cm - box of 100



• 23652 Drape, 200x240 cm with adhesive U shape cut - box of 15



• 23656 Bag to cover instruments 75x90 cm - box of 100



• 23653 Pair of leggings 75x130 cm for urology/gynaec. - box of 20



• 23657 Adhesive strip 10x50 cm - box of 200

TUNGSTEN CARBIDE INSTRUMENTS - GOLD LINE

GOLD LINE - TUNGSTEN CARBIDE INSTRUMENTS

A top quality theatre use Tungsten Carbide Instruments made in stainless steel AISI 410 (AISI 420 for scissors) with very hard tips made in Germany to help surgeons perform precision surgeries with best results. Highly reliable for hardness and corrosion resistance.

TUNGSTEN CARBIDE NEEDLE HOLDERS - AISI 410



26544 Webster needle holder - 12.5 cm



26546 Crile Wood needle holder - 15 cm
26547 Crile Wood needle holder - 18 cm
26545 Crile Wood needle holder - 20 cm



26539 Mayo Hegar needle holder - 14 cm
26530 Mayo Hegar needle holder - 16 cm
26531 Mayo Hegar needle holder - 18 cm
26532 Mayo Hegar needle holder - 20 cm
26535 Mayo Hegar needle holder - 24 cm
26533 Mayo Hegar needle holder - 26 cm
26534 Mayo Hegar needle holder - 30 cm



26540 Olsen Hegar needle holder - 14 cm
26541 Olsen Hegar needle holder - 16.5 cm
26542 Olsen Hegar needle holder - 19 cm



26536 Mathieu needle holder - 14 cm
26537 Mathieu needle holder - 17 cm
26538 Mathieu needle holder - 20 cm



26548 Gillies needle holder - 16 cm



26549 Derf needle holder - 12 cm



TC MICRO NEEDLE HOLDER - AISI 410



26550 Castroviejo Needle Holder straight - 14 cm - plain tip
26552 Castroviejo Needle Holder curved - 14 cm - plain tip
26553 Castroviejo Needle Holder straight - 14 cm - rough tip
26555 Castroviejo Needle Holder curved - 14 cm - rough tip
26551 Castroviejo Needle Holder straight - 18 cm - rough tip
26556 Castroviejo Needle Holder straight - 21 cm - rough tip
26557 Castroviejo Needle Holder curved - 21 cm - rough tip



26554 Castroviejo - 13 cm



38600 Barraquer Micro needle holder - 13 cm - smooth tips - with lock



38610 Arruga needle holder - straight - 16 cm plain tips
38611 Arruga needle holder - curved - 16 cm plain tips

TUNGSTEN CARBIDE FORCEPS - AISI 410

LONG LASTING JOINT
GERMAN TIPS



26560 Adson - 12 cm
26561 Adson 1x2 teeth - 12 cm



26562 Micro Adson forceps - 12 cm - 1x2 teeth
26563 Micro Adson forceps - 15 cm - 1x2 teeth



26558 Gillies Dissecting forceps - 15 cm - 1x2 teeth



26565 Potts Smith Dissecting forceps - 15 cm
26566 Potts Smith Dissecting forceps - 18 cm
26567 Potts Smith Dissecting forceps - 20 cm
26568 Potts Smith Dissecting forceps - 23 cm
26569 Potts Smith Dissecting forceps - 25 cm



38552 Cushing forceps - 18 cm



38554 Cushing Taylor forceps - 18 cm - rough tips



38560 Gerald forceps - 17 cm - rough tips



38565 Mc Indoe forceps - 15 cm - rough tips

TC WIRE CUTTERS - AISI 410



26570 Wire Cutter - 14 cm - for soft wires 0-1 mm
26571 Wire Cutter - 18 cm - for hard wires cutting up to 1.6 mm
26572 Wire Cutter - 23 cm - for hard wires cutting up to 2.0 mm



26575 Wire holding - 18 cm

TC ORGAN HOLDING FORCEPS - AISI 410



26564 Duval - 20 cm

TUNGSTEN CARBIDE INSTRUMENTS - GOLD LINE

TUNGSTEN CARBIDE SCISSORS - AISI 420

**DOUBLE JOINT
GERMAN TIPS**



- 26500 Straight scissors blunt/sharp - 14.5 cm
- 26501 Straight scissors blunt/blunt - 14.5 cm
- 26502 Straight scissors sharp/sharp - 14.5 cm
- 26503 Curved scissors blunt/sharp - 14.5 cm
- 26504 Curved scissors blunt/blunt - 14.5 cm
- 26505 Curved scissors sharp/sharp - 14.5 cm



- 26510 Metzenbaum scissors - straight - 14 cm
- 26511 Metzenbaum scissors - straight - 18 cm
- 26512 Metzenbaum scissors - straight - 20 cm
- 26514 Metzenbaum scissors - curved - 14 cm
- 26515 Metzenbaum scissors - curved - 18 cm
- 26516 Metzenbaum scissors - curved - 20 cm



- 38510 Mayo Stille scissors - straight - blunt - 15 cm
- 38511 Mayo Stille scissors - curved - blunt - 15 cm
- 38514 Mayo Stille scissors - straight - blunt - 17 cm
- 38515 Mayo Stille scissors - curved - blunt - 17 cm



- 26526 Iris scissors - straight - 11.5 cm
- 26527 Iris scissors - curved - 11.5 cm



- 26520 Mayo scissors - straight - 14.5 cm
- 26521 Mayo scissors - straight - 18 cm
- 26524 Mayo scissors - straight - 23 cm
- 26522 Mayo scissors - curved - 14.5 cm
- 26523 Mayo scissors - curved - 18 cm
- 26525 Mayo scissors - curved - 23 cm



- 38520 Kelly scissors - straight - sharp - 16 cm
- 38521 Kelly scissors - curved - sharp - 16 cm



- 26528 Goldman Fox scissors - straight - 13 cm
- 26529 Goldman Fox scissors - curved - 13 cm



- 38530 Lister scissors - 14 cm
- 38532 Lister scissors - 18 cm



- 26507 Debakey Potts Smith scissors - 19 cm - angle 25°
- 26508 Debakey Potts Smith scissors - 19 cm - angle 45°
- 26509 Debakey Potts Smith scissors - 19 cm - angle 60°
- 26517 Debakey Potts Smith scissors - 23 cm - angle 25°
- 26518 Debakey Potts Smith scissors - 23 cm - angle 45°
- 26519 Debakey Potts Smith scissors - 23 cm - angle 60°



- 26506 Universal scissors - 12 cm

KEVORKIAN - S/S



- 26490
- Traditional kevorkian bite (9x3 mm)
Four teeth on bottom jaw
- 26490 KEVORKIAN BIOPSY PUNCH - 20 cm

Textured handle

MINI-TISCHLER - S/S



- 26491
- Single anchoring tooth on top and bottom jaw
- 26491 MINI-TISCHLER - straight - extra long - 25 cm

Textured handle

TISCHLER - S/S



- 26492
- 26493
- Single anchoring tooth on top and bottom jaw
- 26492 TISCHLER KEVORKIAN - extra long - 25 cm
- 26493 TISCHLER - straight - extra long - 25 cm

Textured handle

SUPER CUT SCISSORS

Razor-sharp edge
Micro-fine serrations



- 26488 METZENBAUM SCISSORS SUPER CUT - curved - 15 cm
- 26489 METZENBAUM SCISSORS SUPER CUT - curved - 18 cm

SUPER CUT SCISSORS
Super Cut scissors have a specially designed razor-sharp upper blade edge that cuts effortlessly through tissue. The lower blade has micro-fine serrations to hold tissue and prevent slippage.

Tungsten carbide honed insert combined with razor-sharp edge
Tungsten carbide insert with micro-fine serrations

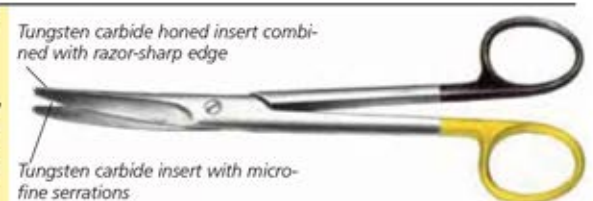



- 26485 MAYO SCISSORS SUPER CUT WITH T.C. - curved - 14 cm
- 26486 MAYO SCISSORS SUPER CUT WITH T.C. - curved - 17 cm
- 26487 MAYO SCISSORS SUPER CUT WITH T.C. - curved - 20 cm

STAINLESS STEEL NEEDLE HOLDERS

CRILE WOOD NEEDLE HOLDER	MAYO HEGAR NEEDLE HOLDER	MATHIEU NEEDLE HOLDER
		
26852 Crile Wood needle holder - 15 cm 26878 Crile Wood needle holder - 18 cm 26879 Crile Wood needle holder - 20 cm	26818 Mayo Hegar needle holder - 14 cm 26732 Mayo Hegar needle holder - 16 cm 26819 Mayo Hegar needle holder - 18 cm 26733 Mayo Hegar needle holder - 20 cm	26741 Mathieu needle holder - 14 cm 26730 Mathieu needle holder - 16 cm 26731 Mathieu needle holder - 20 cm

STAINLESS STEEL SURGICAL SCISSORS

BLUNT/SHARP SCISSORS	BLUNT/BLUNT SCISSORS	SHARP/SHARP SCISSORS
		
26754 Straight scissors blunt/sharp - 11.5 cm 26725 Straight scissors blunt/sharp - 14.5 cm 26729 Straight scissors blunt/sharp - 16 cm 26853 Straight scissors blunt/sharp - 18 cm 26726 Straight scissors blunt/sharp - 20 cm 26755 Curved scissors blunt/sharp - 11.5 cm 26727 Curved scissors blunt/sharp - 14.5 cm 26756 Curved scissors blunt/sharp - 16 cm 26854 Curved scissors blunt/sharp - 18 cm 26728 Curved scissors blunt/sharp - 20 cm	26855 Straight scissors blunt/blunt - 11.5 cm 26740 Straight scissors blunt/blunt - 14.5 cm 26856 Straight scissors blunt/blunt - 16 cm 26857 Straight scissors blunt/blunt - 18 cm 26887 Straight scissors blunt/blunt - 20 cm 26888 Curved scissors blunt/blunt - 11.5 cm 26742 Curved scissors blunt/blunt - 14.5 cm 26889 Curved scissors blunt/blunt - 16 cm 26890 Curved scissors blunt/blunt - 18 cm 26891 Curved scissors blunt/blunt - 20 cm	26892 Straight scissors sharp/sharp - 11.5 cm 26744 Straight scissors sharp/sharp - 14.5 cm 26893 Straight scissors sharp/sharp - 16 cm 26894 Straight scissors sharp/sharp - 18 cm 26895 Straight scissors sharp/sharp - 20 cm 26896 Curved scissors sharp/sharp - 11.5 cm 26746 Curved scissors sharp/sharp - 14.5 cm 26897 Curved scissors sharp/sharp - 16 cm 26898 Curved scissors sharp/sharp - 18 cm 26899 Curved scissors sharp/sharp - 20 cm

LISTER BANDAGE SCISSORS	MAYO-STILLE SURGICAL SCISSORS	METZENBAUM SURGICAL SCISSORS
		
34125 Lister scissors - 11 cm 34129 Lister scissors - 15 cm 34130 Lister scissors - 18 cm	26846 Mayo-stille scissors - straight - 14.5 cm 26847 Mayo-stille scissors - straight - 18 cm 26848 Mayo-stille scissors - straight - 20 cm 26849 Mayo-stille scissors - curved - 14.5 cm 26850 Mayo-stille scissors - curved - 18 cm 26851 Mayo-stille scissors - curved - 20 cm	26840 Metzenbaum scissors - straight - 14.5 cm 26841 Metzenbaum scissors - straight - 18 cm 26843 Metzenbaum scissors - curved - 14.5 cm 26844 Metzenbaum scissors - curved - 18 cm

STITCH REMOVER FORCEPS/SCISSORS

	26737 Spencer scissors - 13 cm for suture
	26722 Michel stitch remover forceps - 12 cm
	26900 Heath's ligature scissors - 15 cm

DELIVERY SCISSORS

	26827 Umbilical scissors Usa model - 10.5 cm
	26874 Brown Sadler episiotomy scissors - 14 cm

IRIS SCISSORS

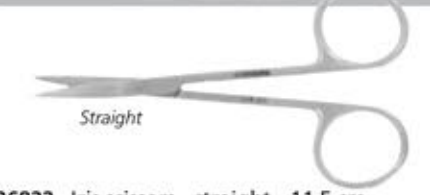
	26822 Iris scissors - straight - 11.5 cm 26824 Iris scissors - curved - 11.5 cm
--	--



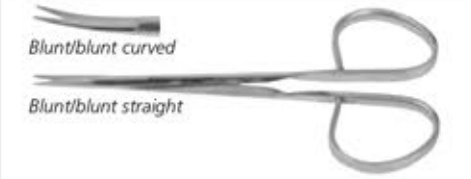

DERMATOLOGY PROBES

	26825 Katsch - 14 cm
	26826 Gillies hook - 15 cm - small
	26821 Unna round - 14 cm
	26820 Unna Oval - 14 cm
	26823 Round forceps - 9 cm

MICRO RIBBON SCISSORS

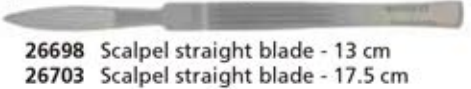
	26956 Ribbon scissors - straight - 9.5 cm 26957 Ribbon scissors - curved - 9.5 cm 26958 Ribbon scissors - straight - 12 cm 26959 Ribbon scissors - curved - 12 cm
---	--

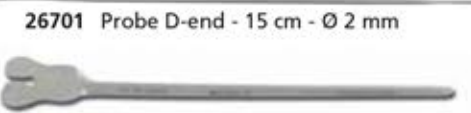
PROBES, SCALPELS

	26698 Scalpel straight blade - 13 cm 26703 Scalpel straight blade - 17.5 cm
	26699 Scalpel pot-bellied blade - 13 cm 26704 Scalpel pot-bellied blade - 17.5 cm
	26701 Probe D-end - 15 cm - Ø 2 mm
	26702 Butterfly probe - 14 cm

S/S INSTRUMENT KITS



code	INSTRUMENTS KIT IN ALUMINIUM BOX OR POLYESTER BAG	26701	26702	26703	26704	26705	26707	26709	26722	26723	26724	26725	26730	26732
26760	Trousse standard - polyester bag 9 instr.	•	•	•	•	•	•	•	•	•	•	•	•	•
26761	Trousse classica - polyester bag 10 instr.	•	•	•	•	•	•	•	•	•	•	•	•	•
26762	Trousse suprema - polyester bag 11 instr.	•	•	•	•	•	•	•	•	•	•	•	•	•
26768	Trousse suprema - aluminium box 11 instr.	•	•	•	•	•	•	•	•	•	•	•	•	•

S/S DRESSING, SUTURE AND DELIVERY SURGERY SETS



• 26963 DRESSING SET - 8 PIECES



• 26965 SUTURE SET - 12 PIECES



• 26966 MINOR DELIVERY SET - 25 PIECES

SET CONTENTS	26963	26965	26966
Kidney Dish 20 cm (8") - medium	•	•	•
Kidney Dish 25 cm (10") - large	•	•	•
Gallipot 150 ml - 6 oz - medium	•	•	•
Mayo Hegar needle holder - 18 cm	•	•	•
Brown Sadler episiotomy scissors - 14 cm	•	•	•
Kocher artery forceps - straight - 16 cm	•	•	•
Kocher artery forceps straight - 18 cm	•	•	•
Kocher artery forceps curved - 16 cm	•	•	•
Dressing Forceps (Thumb) - 16 cm	•	•	•
English TOE dissecting forceps - plain - 14 cm	•	•	•
English TOE dissecting forceps - plain - 18 cm	•	•	•
Dissecting forceps toothed 1x2 - 14 cm	•	•	•
Suture scissors - Heaths Ligature - 15 cm	•	•	•
Mayo scissors - straight - 15 cm	•	•	•
Operating scissors sharp/blunt - straight - 15 cm	•	•	• 2 pcs.
Operating scissors sharp/blunt - curved - 15 cm	•	•	• 2 pcs.
Ramplay sponge holding forceps - str. - 18 cm	•	•	•
Ramplay sponge holding forceps - str. - 24 cm	•	•	• 2 pcs.
Museux Vulsellum forceps 8 mm - str. - 24 cm	•	•	•
Cusco vaginal specula - small	•	•	•
Cusco vaginal specula - medium	•	•	•
Cusco vaginal specula - large	•	•	•
Sims vaginal specula - small	•	•	•
Sims vaginal specula - medium	•	•	•
Sims vaginal specula - large	•	•	•
Umbilical scissors USA Patent - 10.5 cm	•	•	•
Instrument tray with lid 25x30x6.2 cm	•	•	•
Instrument tray with lid 30x20x5 cm	•	•	•
Instrument tray with lid 45x30x6.2 cm	•	•	•

GYNAECOLOGY INSTRUMENTS AND KIT

- 26807 Novak suction cannula - 23 cm - Ø 4 mm
- 26804 ★ Sims hystrometer - malleable - 33 cm - silver
- 26816 Martin hystrometer - 30 cm - malleable - brass handle, copper wire
- 26803 ★ Bosch/Sims scissors - 23 cm
- 26802 ★ Schroeder forceps - 25 cm (Pozzi-Palmer)
- 26801 ★ Foerster forceps - 25 cm



26817 Set of chrome plated Hegar Dilators
Include 14 dilators Ø 4-17 mm



• 26884 SET OF 3 SIMS RETRACTORS



26810

- Rigid cannula with sharp tip
- 26813 Sims uterine curette - sharp - 8 mm - 26 cm
- 26814 Sims uterine curette - sharp - 9 mm - 26 cm
- 26815 Sims uterine curette - sharp - 14 mm - 26 cm
- 26806 Schumacher biopsy forceps - 24cm
- 26808 Schubert biopsy forceps - 21 cm
- 26809 Kogan endospeculum - 24 cm
- 26811 Bozeman dressing forceps straight - 26 cm
- 26812 Bozeman dressing forceps curved - 26 cm

• 26810 GYNAECOLOGY KIT
Includes 4 instruments marked with ★ in a nylon bag.



ENT STAINLESS STEEL INSTRUMENTS AND KIT

<p>Tongue depressors</p>	<p>Nose/ear speculum</p>	<p>Nose Ear forceps and scissors</p>																											
<p>25620 Mayo tongue depressor - 17 cm 25621 Bruenings tongue depr - fenestrated - 19 cm ● 25623 Tobold tongue depressor</p>	<p>26774 Voltolini nose speculum - adjustable - Size 2 ● 26775 Voltolini nose speculum - adjustable - Size 0 26770 Set of 3 earspeculum Hartmann - Ø 4, 5, 6 mm ● 26784 Thudicum nose clip</p>	<p>26773 Lucae ear forceps - 14 cm ● 26783 Troeltsch ear forceps - 12 cm 26779 Hartmann ear forceps - 14 cm 26781 Heymann scissors - 18 cm</p>																											
<p>Suction cannulas</p>	<p>Hooks-Loops</p>	<p>Killian/Hartmann nose forceps</p>																											
<p>26795 Frazier nose/ear suction cannula Ø 2 mm (18 cm) 26796 Frazier nose/ear suction cannula Ø 3 mm (18 cm) 26793 Frazier nose suction cannula Ø 4 mm (18 cm) 26794 Frazier nose suction cannula Ø 5 mm (18 cm) 26797* Rosen ear suction cannula Ø 1.5 mm (55 mm) 26798* Rosen ear suction cannula Ø 3 mm (55 mm) *with adaptor with LUER tip and thumb valve</p>	<p>26771 Lucae Hook - 14 cm (5 1/4") ● 26769 Lucae Hook - fine - 14 cm (5 1/4") 26790 Billeau Loop - 16 cm 26785 Swab holder - 16 cm</p>	<p>26792 Killian/Hartmann nose forceps - 14 cm (5 1/4")/15 mm 26778 Killian/Hartmann nose forceps - 14 cm (5 1/4")/22 mm 26772 Killian/Hartmann nose forceps - 14 cm (5 1/4")/35mm ● 26776 Killian/Hartmann nose forceps - 14 cm (5 1/4")/50mm 26764 Killian/Hartmann nose forceps - 14 cm (5 1/4")/75mm 26777 F. O. Killian nose forceps - 14 cm/75mm fiber optic 26765 Tieck Halle nose speculum - 14 cm</p>																											
<table border="1"> <thead> <tr> <th rowspan="2">code</th> <th colspan="3">Hartmann ear forceps</th> <th rowspan="2">Picture</th> </tr> <tr> <th>A</th> <th>B</th> <th>C</th> </tr> </thead> <tbody> <tr> <td>26782</td> <td>90</td> <td>11</td> <td>0.6</td> <td></td> </tr> <tr> <td colspan="5">Hartmann micro forceps</td> </tr> <tr> <td>26786</td> <td>80</td> <td>6</td> <td>0.3</td> <td rowspan="2"></td> </tr> <tr> <td>26787</td> <td>80</td> <td>4</td> <td>0.6</td> </tr> </tbody> </table>	code	Hartmann ear forceps			Picture	A	B	C	26782	90	11	0.6		Hartmann micro forceps					26786	80	6	0.3		26787	80	4	0.6	<p>● 26788 MICRO EAR CUP-SHAPED POLYPUS FORCEPS A = 80 mm, B = 4 mm</p> <p>● 26789 MICRO EAR SCISSORS BELLUCCI A = 80 mm, B = 4 mm C = 0,8 mm tip thickness</p> <p>● 26791 MICRO EAR PUNCH - introduction instrument A = 80 mm, B = 4 mm</p>	<p>26780</p> <p>● 26780 ENT KIT Includes all instruments marked with ● inside an aluminium box (Code 26665) 21x10xh 5 cm.</p>
code		Hartmann ear forceps				Picture																							
	A	B	C																										
26782	90	11	0.6																										
Hartmann micro forceps																													
26786	80	6	0.3																										
26787	80	4	0.6																										

LARYNGEAL MIRRORS AND SPIRIT LAMP

<p>31614</p>	<p>31612</p>	<table border="1"> <thead> <tr> <th>code</th> <th>LARYNGEAL MIRROR - STRAIGHT - 13 CM</th> <th>Minimum order</th> </tr> </thead> <tbody> <tr> <td>31600</td> <td>Mirror number 000 diameter 10 mm</td> <td rowspan="9">10 pcs. mixed sizes</td> </tr> <tr> <td>31601</td> <td>Mirror number 00 diameter 12 mm</td> </tr> <tr> <td>31602</td> <td>Mirror number 0 diameter 14 mm</td> </tr> <tr> <td>31603</td> <td>Mirror number 1 diameter 16 mm</td> </tr> <tr> <td>31604</td> <td>Mirror number 2 diameter 18 mm</td> </tr> <tr> <td>31605</td> <td>Mirror number 3 diameter 20 mm</td> </tr> <tr> <td>31606</td> <td>Mirror number 4 diameter 22 mm</td> </tr> <tr> <td>31607</td> <td>Mirror number 5 diameter 24 mm</td> </tr> <tr> <td>31608</td> <td>Mirror number 6 diameter 26 mm</td> </tr> </tbody> </table>	code	LARYNGEAL MIRROR - STRAIGHT - 13 CM	Minimum order	31600	Mirror number 000 diameter 10 mm	10 pcs. mixed sizes	31601	Mirror number 00 diameter 12 mm	31602	Mirror number 0 diameter 14 mm	31603	Mirror number 1 diameter 16 mm	31604	Mirror number 2 diameter 18 mm	31605	Mirror number 3 diameter 20 mm	31606	Mirror number 4 diameter 22 mm	31607	Mirror number 5 diameter 24 mm	31608	Mirror number 6 diameter 26 mm
code	LARYNGEAL MIRROR - STRAIGHT - 13 CM	Minimum order																						
31600	Mirror number 000 diameter 10 mm	10 pcs. mixed sizes																						
31601	Mirror number 00 diameter 12 mm																							
31602	Mirror number 0 diameter 14 mm																							
31603	Mirror number 1 diameter 16 mm																							
31604	Mirror number 2 diameter 18 mm																							
31605	Mirror number 3 diameter 20 mm																							
31606	Mirror number 4 diameter 22 mm																							
31607	Mirror number 5 diameter 24 mm																							
31608	Mirror number 6 diameter 26 mm																							
<p>● 31616 ADJUSTABLE MIRROR HANDLE - 12.5 cm ● 31615 ADJUSTABLE MIRROR HANDLE - 8 cm</p> <p>31615+31606 31616+31605</p>	<p>● 31612 SET 9 LARYNGEAL MIRRORS 000-6 Set of 9 laryngeal mirrors from 000 to 6, all mirrors have a different diameter: from 10 mm to 26 mm. minimum order: 1 set of 9 mirrors</p> <p>● 31614 SPIRIT LAMP - 100 ml Lamp is made of AISI 304 stainless steel. Brass cap to close flame area to avoid discoloration.</p>																							

PODIATRY-CHIROPODY STAINLESS STEEL INSTRUMENTS



SCISSORS

26870 Cuticle scissors - 9 cm



26871 Nail scissors - 9 cm



39700 Cuticle scissors - curved - 9.5 cm



39710 Nostril small scissors - 9 cm



39720 Dissecting scissors - 11.5 cm



TWEEZERS

26875 Tweezers - 8 cm



26876 Tweezers - 9.5 cm



39730 Loop excavator - 11 cm



39735 File for nails - 13.5 cm



39740 Excavator - 13 cm



39746 Chisel - 14.5 cm



PEDICURE FILES

39790 File rasp double sided - 21.5 cm - metal handle



39792 File rasp double sided - 23.5 cm - plastic handle



39794 File rasp double sided - 24 cm - metal handle



39798 Pedicure cutter - 14.5 cm - plastic handle
39799 Blades for pedicure cutter - box of 10



CUTTERS/NIPPERS

26880 Nail Cutter - 14 cm



26881 Nail Cutter Slant Jaws - 14 cm



26882 Nail Cutter with 4 hinges - 16 cm - with spiral spring



26883 Ingrowing Nail Cutter - 11.5 cm



26885 Cuticle Nipper - 11.5 cm



26886 Nail Nipper - 12.5 cm



39760 Nail Corner - 10 cm



39770 Nail Cutter - 14 cm - with spiral spring



PODIATRY STAINLESS STEEL KITS

• 39800 HEART SHAPE KIT - blue

Cuticle nipper 10 cm, Nail nipper 10 cm, Nail scissors 9.5 cm, Nail file 10 cm, Pusher double ended 12 cm, Tweezers 10 cm



• 39805 STEEL FRAME KIT

Nail nipper 10 cm, Nail Scissor 9.5 cm, Cuticle scissors 9.5 cm, Cuticle pusher double ended 12 cm, Cuticle pusher and cleaner 13 cm, Tweezers 9 cm, Nail file with white plastic handle 9 cm



• 39810 PROFESSIONAL KIT

Nail nipper Moon Shape 14 cm, Side cutter 13 cm, Cuticle Nipper 10 cm, Dressing Scissors 14 cm, B.P. handle No. 4 13.5 cm, Splinter Tweezers 12 cm, Loop 14 cm, Knife & Cleaner double ended 16 cm, Nail file 12 cm, Nail file with white plastic handle 13 cm, Spatula double ended 15 cm



STAINLESS STEEL RETRACTORS

26865

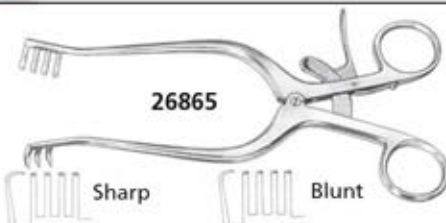

Sharp

Blunt

26858 Weitlaner-Loktite retractor - sharp 13 cm - 3x4 prongs

26859 Weitlaner-Loktite retractor - blunt 13 cm - 3x4 prongs

26865 Weitlaner Retractor - sharp 20 cm - 3x4 prongs

26866 Weitlaner Retractor - blunt 20 cm - 3x4 prongs



30x10 mm
26x10 mm

30x13 mm
34x13 mm

26867 Farabeuf retractors - set of 2 - 12 cm

26868 Frazier Hook - sharp - 13 cm

26869 Frazier Hook - blunt - 13 cm

Sharp Blunt

26723 Hook - 15 cm



26860 Masing Retractor - 14 cm



Senn-Muller - 16 cm

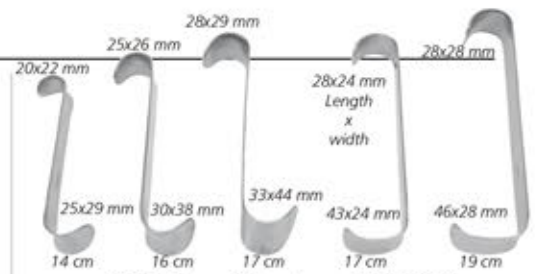

26877 Roux Retractor set of 5 (3+2)

Sharp

Blunt

26862 Volkman- 3 teeth - sharp - 22 cm

26863 Volkman- 3 teeth - blunt - 22 cm



26861 Langenbeck Retractor - 22 cm

DENTAL STAINLESS STEEL INSTRUMENTS

EXTRACTING-FORCEPS - FOR JAWS



60040
set of 10 perforated
impression trays
(5 lower + 5 upper)



60045
set of 10 solid impression
trays (5 lower + 5 upper)
Above impression trays sets
have below sizes

		UPPER SIZES mm				
		U1	U2	U3	U4	U5
A	62	60	53	54	52	
B	83	75	73	69	68	

		LOWER SIZES mm				
		L1	L2	L3	L4	L5
A	63	61	57	60	53	
B	82	81	78	74	71	

fig. 1 60000 upper 17.5 cm	fig. 2 60001 upper 17.5 cm	fig. 7 60002 upper 17.5 cm	fig. 17 60003 upper 17.5 cm	fig. 18 60004 upper 17.5 cm	fig. 29 60005 upper 17.5 cm
fig. 51 60006 upper 18.5 cm	fig. 67A 60007 upper 18.5 cm	fig. 16 60015 lower 18.5 cm	fig. 22 60016 lower 15.4 cm	fig. 74N 60017 lower 15.1 cm	fig. 79 60018 lower 17.5 cm
fig. 151 60019 lower 18.5 cm					

EXPLORER AND PROBES

60101 Explorer - fig. 17/23
60100 Explorer probe
60105 WHO probe

GRACEY AND Mc CALL CURETTES

60120 Mc Call curettes - fig. 13/14
60125 Gracey curette - fig. 1/2 ant.
60127 Gracey curette - fig. 7/8 medium
60130 Gracey curette - fig. 11/12 medium
60131 Gracey curette - fig. 13/14 post.

SCALER

60140 Scaler - fig. 1
60141 Mc Call scaler - fig. 18
60142 Mitchel scaler
60144 Langer scaler - fig. 1/2
60145 Langer scaler - fig. 3/4
60148 Hygienist scaler - fig. H6/7
60150 Scaler - fig. 2045
60155 Periodontia instr. - fig. ST 2/3
60156 Periodontia instr.

CARVER

60170 Cement spatula
60171 Wiland modelling carver
60172 Interproximal modelling carver
60173 Beale modelling carver - mod. 7A
60174 Fahnenstock - modelling carver - 13 cm

FORCEPS

60190 London college forceps - 15 cm

CARTRIDGE SYRINGE

60195 Cartridge Syringe - 2.2 cc with thread in millimeter with aspiration

60200	60201	60202	60203	60204	60205	60210	60220 - 11 cm	60221 - 14 cm	60225	60226
3 mm	4 mm					Amalgam carrier	Molt Mouth gag	Molt Mouth gag	Bone Cutter	Beyer Forceps
									- 15 cm	- 18 cm

DISPOSABLE METAL INSTRUMENTS - STERILE

A complete range of disposable instruments designed to provide users with good quality, sturdy all-metal alternative to plastic disposable instruments. Each instrument has a blue coloured part to avoid mix with reusable instruments and is individually packed in a single sterile pouch. Sterilized by Gamma radiation. Sold in box of 10 or 25 pouches.



BLUE HANDLES
for instant identification
as disposable

STERILE SCISSORS

- **38800** Surgical scissors sharp/sharp - straight - 13 cm - box of 25
- **38801** Surgical scissors sharp/blunt - straight - 13 cm - box of 25

- **38809** Metzenbaum scissors - straight - 16 cm - box of 25
- **38810** Metzenbaum scissors - curved - 16 cm - box of 25
- **38812** Metzenbaum scissors - curved - 18 cm - box of 25

- **38830** Iris scissors sharp/sharp - straight - 11.5 cm - box of 25
- **38831** Iris scissors sharp/sharp - curved - 11.5 cm - box of 25

- **38820** Mayo scissors - straight - 15 cm - box of 25
- **38822** Mayo scissors - straight - 17 cm - box of 25

- **38840** Lister bandage scissors - 14 cm
- **38841** Lister bandage scissors - 16 cm
- **38842** Lister bandage scissors - 18 cm - box of 25

- **38835** Umbilical scissors - straight - 10.5 cm - US model - box of 25

STERILE FORCEPS

- **38850** Dressing tissue forceps - straight - 13 cm - box of 25
- **38852** Dressing tissue forceps - straight - 16 cm - box of 25
- **38851** Dressing forceps - straight - 13 cm 1x2 teeth - box of 25

- **38860** Pean forceps - curved - 14 cm
- **38861** Pean forceps - curved - 16 cm
- **38862** Pean forceps - curved - 18 cm - box of 25

- **38885** Splinter plain forceps - 12.5 cm - box of 25

- **38895** Micro Hartmann ear forceps - 15 cm - 3 mm - box of 10
- **38897** Micro Bellucci ear scissors - 15 cm - 3 mm - box of 10

- **38865** Spencer Wells forceps - straight - 13 cm - box of 25

- **38875** Haemostatic Halstead-Mosquito artery forceps - straight - 12.5 cm - box of 25
- **38876** Haemostatic Halstead-Mosquito artery forceps - curved - 12.5 cm - box of 25

- **38887** Foerster polypus forceps - 25 cm - box of 10

- **38920** Mayo-Hegar needle holder - 14 cm - box of 25
- **38921** Mayo-Hegar needle holder - 16 cm - box of 25

- **38870** Adson tissue forceps - straight - 12 cm - box of 25
- **38871** Adson tissue forceps - straight - 12 cm 1x2 teeth - box of 25

- **38880** McIndoe dissecting forceps - straight - 15 cm - box of 25

- **38890** Magill forceps - 20 cm for children - box of 10
- **38891** Magill forceps - 25 cm for adult - box of 10

STERILE NEEDLE HOLDERS

- **38930** Crile Wood needle holder - 15 cm - box of 25

SINGLE USE STERILE PROCEDURE PACKS

Sold in box of 25

- **38950** SUTURE REMOVAL PACK
Iris scissors - straight - 11.5 cm
Adson tissue forceps toothed - 12 cm

Sold in box of 25

- **38951** SUTURE PROCEDURE PACK
Spencer ligature scissors - straight - 9 cm
Adson tissue forceps toothed - 12 cm

Sold in box of 10

- **38952** STANDARD SUTURE PACK
Kilner needle holder - 13 cm
Spencer Stitch scissors - straight - 9 cm
Treeves toothed dissecting forceps - 13 cm
T.O.E. (Turnover End) forceps - 13 cm
Super crepe sheet

Sold in box of 10

- **38953** STANDARD DELIVERY PACK
Umbilical scissors - 10.5 cm - US model
Mayo gynaecological scissors - straight - 17 cm
2x Spencer Wells artery forceps - straight - 13 cm
2x Umbilical cord clamps
Super crepe sheet

STERILE MEDICATION, SUTURE, CATHETERIZATION KITS



• 26930 DRESSING KIT 1 - sterile



• 26929 DRESSING KIT 2 - sterile



• 26933 CATHETERIZATION KIT - sterile



• 26936 SUTURE REMOVAL KIT 1 - sterile



• 26937 SUTURE REMOVAL KIT 2 - sterile



• 26932 SUTURE REMOVAL KIT 3 - sterile

KIT CONTENT	Dressing		Suture		Suture removal			Catheters
	26930	26929	26931	26934	26932	26936	26937	26933
Field cloth	•		•		•			•
Cushing surgery forceps			•		•			•
Needle Holder			•		•			•
Anatomy forceps	•	•	•	•	•	•	•	•
Ring shaped forceps	•	•	•	•	•			•
Styptic clamp (Kelly forceps)			•		•			•
Haemostatic clamp			•		•			•
Straight scissors			•		•			•
Metal forceps		•	•	•	•			•
Littauer scissors		•	•	•	•	•		•
Gauze swabs 7.5x7.5 cm 8 ply	•	•	•	•	•			•
Gauze swabs 10x10 cm 8 ply			•	•	•			•
4 or 5 Gauze plugs	•		•	•	•			•
3 Gauze plugs		•	•	•	•			•
Gauze swabs 10x20 cm - 8 plies		•	•	•	•			•
Gauze swab 18x40 cm						•		•
Latex gloves - medium			•	•	•			•
Vinyl gloves								•
Disposable big bag			•	•	•			•
Medication plaster 15x12 cm					•			•
WNW (TNT)+PE drape 32x50 cm		•	•	•				•
WNW (TNT) compresses								•
WNW (TNT)+PE drape 50x60 cm with hole				•				•
Water syringe								•
Single dose lubricant								•
Single dose disinfectant								•
Chlorexidina wipe				•				•
2 adhesive WNW (Woven Non Woven) strips				•				•
Waste bag		•						•
Scalpel with handle								•
2 cotton applicators								•



• 26931 SUTURE KIT 1 - sterile



• 26934 SUTURE KIT 2 - sterile

GENERAL SURGERY PROCEDURE PACK



26985

• 26985 GENERAL SURGERY PACK - sterile

Ready to use pack including all necessity for a general surgery procedure.

Peel open PE + tyvek envelope.

Sterile EO.

KIT CONTENT

1 table cover 150x200 cm	4 hand towel
2 surgical gown XL	1 bowl 90 ml
2 adhesive drapes 75x90 cm	1 kidney dish
1 foot drape (ADH side) 150x175 cm	10 scalpel n°15
1 head drape (ADH side) 150x240 cm	5 gauze swabs 10x20 cm
2 syringes 10 ml	4 gauze balls 30 mm
2 needles 21Gx1.5"	2 foam stick 15 cm
1 scalpel n°11	1 basic tray



SUTURES - FINE WOUND CLOSURE MATERIAL

CLINISILK STERILE BLACK BRAIDED SILK SUTURE B.P.

Non-absorbable sutures made from pure natural silk, braided to form a multifilament thread, double treated with a silicone coating to prevent capillarity and to enhance ease of passage through tissue. Silk sutures are considered to have the best handling and tying characteristics. Suture length: 45 cm.

Application: soft tissue approximation and ligation.

CLINILON STERILE BLUE MONOFILAMENT NYLON SUTURE B.P.

Non-absorbable synthetic monofilament suture made from Polyamide 6.6. No tissue reaction, excellent tensile strength, easy handling and secure knotting.

Suture length: 45 cm. Nylon is a highly favoured material for skin closure. Application: skin closure, general soft tissue approximation and ligation.

GIMA code		CLINISILK AND CLINILON SUTURES - pack of 12 pcs.					
Silk	Nylon	Gauge	Metric	Needle	Needle shape	Type of needle	Suture length
25910	25920	2/0	3	26 mm	3/8	Reverse cutting	45 cm
25911	-	3/0	2	22 mm	1/2	Conventional cutting	45 cm
-	25921	3/0	2	20 mm	3/8	Conventional cutting	45 cm
25912	25922	3/0	2	24 mm	3/8	Reverse cutting	45 cm
-	25923	3/0	2	25 mm	3/8	Fine conventional cutting	45 cm
25914	25924	4/0	1.5	19 mm	3/8	Reverse cutting	45 cm
-	25925	5/0	1	16 mm	3/8	Reverse cutting	45 cm
25916	25926	5/0	1	19 mm	3/8	Reverse cutting	45 cm
-	25927	6/0	0.7	12 mm	3/8	Reverse cutting	45 cm
25918	25928	6/0	0.7	16 mm	3/8	Reverse cutting	45 cm

CLINITRO SUTURES: BLUE POLYVINYLIDENE FLUORIDE MONOFILAMENT NON ABSORBABLE PVDF SUTURE

It is indicated in procedures where non-absorbable monofilament sutures are required, especially skin and fascia closure. CliniTro is used in place of nylon for skin closure. The material is much softer and more pliable.

Tensile strength is higher than nylon and knot holding is far superior.

Our SG (Super Glide) are all premium reverse cutting needles. Specifically suggested for dermatology and plastic surgery are our equivalents to Ethicon's Multipass needles.

code		CLINITRO SUTURES - pack of 12 pcs.					
Gauge	Metric	Needle	Needle shape	Type of needle	Suture length		
25930	2/0	3	24 mm	3/8	Reverse cutting	70 cm	
25931	3/0	2	24 mm	3/8	Reverse cutting	70 cm	
25932	4/0	1.5	19 mm	3/8	Reverse cutting	70 cm	
25933	5/0	1	19 mm	3/8	Reverse cutting	70 cm	
25934	5/0	1	16 mm	3/8	Reverse cutting	70 cm	
25935	6/0	0.7	13 mm	3/8	Reverse cutting	45 cm	

CLINISORB STERILE VIOLET BRAIDED PGA SYNTHETIC ABSORBABLE SUTURE

CliniSorb is a synthetic absorbable braided suture made from a polymer of Glycolic acid. This material is inert, non collagenous, non-antigenic, non-pyrogenic and has a high tensile strength and predictable absorption rate, allowing wound support for approx. 21 days, complete absorption in 56-70 days. It is treated with a surface coating to ensure smooth tissue passage and enhance knot sliding.

No risk of infection, inflammatory processes or exposure to protein digesting enzymes in the gastro intestinal tract. Suitable for both skin closure and where non-permanent wound support is indicated. Application: dental, general skin closure, gynaecology, plastic and general surgery, orthopedics and urology.

code		CLINISORB SUTURES - pack of 12 pcs. - synthetic					
Gauge	Metric	Needle	Needle shape	Type of needle	Suture length		
25900	2/0	3	24 mm	3/8	Reverse cutting	70 cm	
25901	3/0	2	19 mm	3/8	Reverse cutting	45 cm	
25902	4/0	1.5	19 mm	3/8	Reverse cutting	45 cm	

CLINIMONO Q SYNTHETIC MONOFILAMENT

Undyed monofilament rapid absorbable sutures composed of PGCL. Complete absorption in 90 days. Suitable for soft tissue approximation and ligation but not for cardiovascular or neurological procedures. This product is our equivalent to Ethicon's Monocryl. Also used for subcutaneous and subcuticular closure in general surgery as well as skin closure for out of town patients who cannot return to have suture removed.

code		CLINIMONO Q SUTURES - pack of 12 pcs.					
Gauge	Metric	Needle	Needle shape	Type of needle	Suture length		
25904	2/0	3	24 mm	3/8	Reverse cutting	70 cm	
25905	3/0	2	24 mm	3/8	Reverse cutting	70 cm	
25906	4/0	1.5	19 mm	3/8	Reverse cutting	70 cm	
25907	5/0	1	16 mm	3/8	Reverse cutting	70 cm	
25908	6/0	0.7	11 mm	3/8	Reverse cutting	45 cm	



Supplied with manual in GB, FR, IT, PT, ES, Arabic.

DISPOSABLE SKIN STAPLER DEVICE



• 25890 DISPOSABLE STERILE SKIN STAPLER

Simple and easy to operate. Staples are made of High Quality 317 L Stainless Steel for medical use, each device is provided of 35 staplers. High sewing up and stapling speed help shorten the time of sewing and avoid cross infection of contagious diseases. Reduced tissue reaction, thinner scar after operation and faster wound healing. Painless and convenient staples removal after the incision has healed up.

To be used for skin closure in operating room, labour and delivery, emergency department, outpatient surgery, clinics and physician's office.

SKIN STAPLE REMOVER



• 25892 DISPOSABLE REMOVER FORCEPS - box of 20 pcs.

Practical disposable forceps for removing regular and wider size staples. Sterile.

• 25895 SR-3 DISPOSABLE SKIN STAPLE REMOVER - box of 10 pcs.

3M original forceps for removing staples. Sterile. 26737

S/S STITCH/SUTURE REMOVERS:

• 26737 SPENCER SCISSORS - 13 cm

• 26722 MICHEL STITCH REMOVER

FORCEPS - 13 cm



26722

SKIN MARKER



Ultra fine tip

With ruler in mm

Regular tip

• **33179 SKIN MARKER - dual tips gentian violet - box of 10**
Double tips skin marker with polypropylene cap and body. Polyester fiber tips. Ultra fine tip utility marker to write on adhesive labels and infusion bags.

Regular tip surgical skin marker for use on patient skin.
Washable with water and soap. Size 138xØ 12.5 mm. Multilanguage box and manual: GB, FR, IT, DE, ES, PT, GR, PL, SE, RO, HU, Arab.

DERMATOGRAPH MARKERS



- **33175 DERMATOGRAPH MARKER - blue**
- **33176 DERMATOGRAPH MARKER - white**
- **33177 DERMATOGRAPH MARKER - red**
- **33178 DERMATOGRAPH MARKER - mix***

*2 pencils each colour

Special dermatograph pencil to mark the skin for identification of areas to be treated. Made in cedar wood with

wax lead. Size 175xØ 7 mm. Suitable for general surgery, dermatology, orthopaedy, radiology, ...
Pencils are sold non sharpened in box of 6 with 1 pencil sharpener included. Multilanguage box and manual: GB, FR, IT, DE, ES, PT, GR, PL, SE, RO, HU, Arab.

SKIN MARKER - STERILE



TWO TIPS IN ONE:



For heavier lines, hold the pen at an angle and use the shoulder of the tips (2 mm)



Hold the pen vertically while applying a fine line (0.2 mm)

• **33181 CLINICON® - fine tip - sterile - box of 10**
The Clinicon® Surgical Skin Marker features a versatile tip for precise fine line marking preferred in plastic surgery or when held at an angle, broad line marking for applications in general, neuro and vascular surgery, as well as radiology and radiation therapy. The marker's high visibility Gentian violet ink is nontoxic, non tattooing and surgical prep-resistant. Markings can be removed from the skin with isopropyl (rubbing) alcohol. The package is easy to open, HIBC bar coded and includes a separate six inch, flexible ruler calibrated in both inches and centimeters. Sterile EO.

ETHICON SUTURES - ABSORBABLE AND NON ABSORBABLE



ETHICON



NON ABSORBABLE STERILE SURGICAL SUTURES									
code	ETHICON code	Gauge	Metric	Colour	Circle	Needle length	Needle	Suture length	Minimum order
ETHILON - monofilament suture									
22300	660H	6/0	0.7	Black	3/8	16 mm	FS-3	45 cm	box of 36
22301	661H	5/0	1.0	Black	3/8	19 mm	FS-2	45 cm	box of 36
22302	662H	4/0	1.5	Black	3/8	19 mm	FS-2S	45 cm	box of 36
22303	663H	3/0	2.0	Black	3/8	24 mm	FS-1	45 cm	box of 36
22304	EH7506H	3/0	2.0	Black	3/8	19 mm	FS-2	45 cm	box of 36
22305	EW661	5/0	1.0	Blue	3/8	19 mm	FS-2	75 cm	box of 36
PERMA-HAND - silk sutures - braided									
22310	18501G	4/0	1.5	Black	1/2	17 mm	J-1	45 cm	box of 12
22311	18502G	3/0	2.0	Black	1/2	22 mm	X-1	45 cm	box of 12
22312	18505G	2/0	3.0	Black	1/2	22 mm	X-1	45 cm	box of 12
22313	18507G	4/0	1.5	Black	Straight	19 mm	ST-4	45 cm	box of 12
22314	18508G	4/0	1.5	Black	3/8	13 mm	P-3 prime	45 cm	box of 12
22315	18509G	3/0	2.0	Black	1/2	22 mm	SH-1 Plus	45 cm	box of 12
22316	EH7149G	4/0	1.5	Black	3/8	19 mm	FS-2	45 cm	box of 12
PROLENE - blue pigmented monofilament sutures									
22320	EH7150H	4/0	1.5	Blue	3/8	19 mm	FS-2	75 cm	box of 36
22321	EH7151H	4/0	1.5	Blue	3/8	19 mm	FS-2	45 cm	box of 36
22322	W8873T	6/0	0.7	Blue	3/8	16 mm	PC-3 Prime	45 cm	box of 24

Non absorbable surgical sutures are indicated for use in general soft tissue approximation and/or ligation included use in cardiovascular, ophthalmic and neurosurgical procedures

ABSORBABLE STERILE SURGICAL SUTURES									
code	ETHICON code	Gauge	Metric	Colour	Circle	Needle length	Needle	Suture length	Minimum order
MONOCRYL - complete absorption in 91-119 days									
22350	Y493H	5/0	1.0	Undyed	3/8	19 mm	P-3 prime	45 cm	box of 36
VICRYL Plus is indicated for use in general tissue approximation and/or ligation except for ophthalmic, neuro, cardiovascular									
VICRYL PLUS BRAIDED - complete absorption in 56-70 days									
22360	VCP392ZH	4/0	1.5	Violet	3/8	19 mm	FS-2	45 cm	box of 36
22361	VCP305H	3/0	2.0	Violet	1/2	17 mm	RB-1 Plus	70 cm	box of 36
22362	VCP452H	2/0	2.0	Violet	3/8	24 mm	FS-1	70 cm	box of 36
22363	VCP453H	2/0	3.0	Violet	3/8	24 mm	FS-1	70 cm	box of 36
Vicryl Rapid Braided indicated only for: use in superficial soft tissue approximation of the skin and mucosa, where only short term (7-10 days) wound support is required.									
VICRYL RAPID BRAIDED - complete absorption in 42 days									
22370	V76H	3/0	2.0	Undyed			J-1	45 cm	box of 36
22371	V2920G	4/0	1.5	Undyed	3/8	19 mm	FS-2	45 cm	box of 12
22372	V2930G	3/0	2.0	Undyed	3/8	19 mm	FS-2	45 cm	box of 12
22373	V2150G	3/0	2.0	Undyed	1/2	17 mm	RB-1 Plus	70 cm	box of 12
22374	V2190G	3/0	2.0	Undyed	1/2	22 mm	SH-1 Plus	70 cm	box of 12
22375	VR2298	3/0	2.0	Undyed	3/8	14 mm	FS-2	75 cm	box of 36

GIMA: DISPOSABLE S/S SCALPELS & STAINLESS OR CARBON STEEL BLADES

"GIMA" DISPOSABLE BLADES - sterile - dispenser box of 100
Surgical blades are available in high quality carbon steel and stainless steel with or without safety round tip. Manufactured in accordance with the requirements of British Standards BS 2982:1992, ISO 7740:1985, ISO 7153-1: 1991, EN 10088-3: 2005. Each blade is hallmarked and individually packed in aluminium foil. Carbon Steel blades are VPI paper protected. Blade size is clearly identified on the reverse side of the foil peel-pack and on product unit boxes.



"GIMA" DISPOSABLE SCALPELS - sterile - box of 10
S/S blade fitted into an ABS plastic handle. Individually packed in sterilized envelope. Safety blade guard for premium model.



"GIMA" SAFETY PROTECTIVE SHIELD SCALPELS - sterile
Protective scalpels with a clear view shield that protects against injuries before use, between steps of procedure and after disposal. Latex and phthalates free.

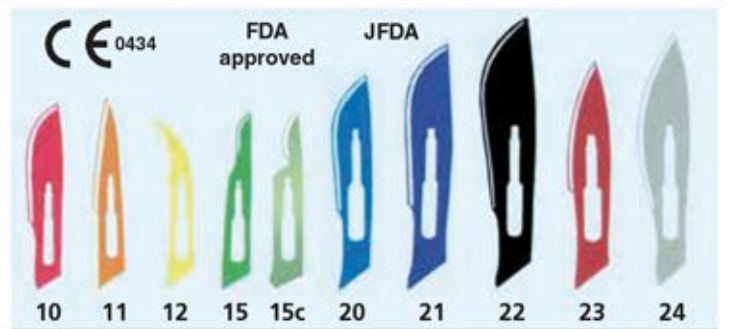

code	SCALPEL HANDLES - STAINLESS STEEL			GIMA STERILIZED BLADES
26913	Scalpel Handle N° 3 for blades 10-15			Carbon steel scalpel blades
26914	Scalpel Handle N° 4 for blades 20-25			
	Carbon steel box of 100	Stainless steel box of 100	Safety stain. steel box of 100	
27000	27020	27030		Sterilized blades No. 10
27001	27021	-		Sterilized blades No. 11
27002	27022	-		Sterilized blades No. 12
27003	27023	27033		Sterilized blades No. 15
27009	-	-		Sterilized blades No. 15c
27004	27024	27034		Sterilized blades No. 20
27005	27025	27035		Sterilized blades No. 21
27006	27026	27036		Sterilized blades No. 22
27007	27027	27037		Sterilized blades No. 23
27008	27028	27038		Sterilized blades No. 24
Premium Model	Standard Model	Safety Model	GIMA STERILIZED DISPOSABLE SCALPELS STAINLESS STEEL (PACK OF 10 PCS.)	
27040	27060	27070	Disposable scalpels - blade 10	
27041	27061	27071	Disposable scalpels - blade 11	
27042	27062	-	Disposable scalpels - blade 12	
27043	27063	27073	Disposable scalpels - blade 15	
27049	-	-	Disposable scalpels - blade 15c	
27044	27064	27074	Disposable scalpels - blade 20	
27045	27065	27075	Disposable scalpels - blade 21	
27046	27066	27076	Disposable scalpels - blade 22	
27047	27067	27077	Disposable scalpels - blade 23	
27048	27068	27078	Disposable scalpels - blade 24	

SAFETY HANDLE

- 26915 SAFETY S/S HANDLE N 3 for blades 10-15
 - 26916 SAFETY S/S HANDLE N 4 for blades 20-25
- Innovative handle allows hand-free removal of blade in compliance with OSHA and CDC.



SHARP INJURY PREVENTION WITH SAFETY HANDLE AND BLADES

PARAGON BLADES AND SCALPELS

"PARAGON" DISPOSABLE S/S BLADES - sterile
High quality blades manufactured with best British stainless steel guarantee excellent sharpening and perfect cut control. Individually packed in metal foil. Gamma rays sterilized.



"PARAGON" DISPOSABLE SCALPELS WITH S/S BLADE - sterile
Grip on the plastic handle allows stability for long straight incisions. Individually packed in sterilized envelope, reinforced with blade protection, in cardboard box of 10 units.

Blades box of 100	Scalpels box of 10	STERILE, S/S BLADE
26901	26920	Blade 10
26902	26921	Blade 11
26903	26922	Blade 12
26904	26923	Blade 15T
26905	26924	Blade 20
26906	26925	Blade 21
26907	26926	Blade 22
26908	26927	Blade 23
26909	26928	Blade 24

Multilanguage box: GB, FR, IT, ES, DE, DK, NL, GR, PT, PL, FI, RU, NO, SE

KAI DISPOSABLE BIOPSY BLADE



• 26935 BIOPSY BLADE - box of 20 pcs - sterile
A new stainless steel biopsy product from the experience of KAI: blade with sure grip handle for precise biopsy. Sterile and ready to use. For use in dermatology, gynecology and podiatry.





SINGLE-USE STERILE DERMAL CURETTES



Stainless steel sharp cutting edge for soft or weak tissue.
Size embossed on each curette for easy identification.

Sterile ready-to-use. Use once and discard eliminates need for re-sharpening and sterilization. Wide range of sizes.

Used in the following minor surgical skin procedures:
Curettage of a basal cell carcinoma, curettage of a verruca and curettage of any other benign neoplasms of the skin.

Clinical Areas: dermatology, surgical, podiatry, veterinary

Made in Japan

code	DERMAL CURETTES	Minimum order
22602	Dermal Curettes Ø 2 mm	box of 20
22603	Dermal Curettes Ø 3 mm	box of 20
22604	Dermal Curettes Ø 4 mm	box of 20
22605	Dermal Curettes Ø 5 mm	box of 20
22606	Dermal Curettes Ø 7 mm	box of 20

LATEX FREE



SINGLE-USE STERILE BIOPSY PUNCHES - LATEX FREE

Stainless steel sharp cutting edge, ribbed handle for sure grip. Size embossed on each punch for easy identification. Suggested for dermatology, gynaecology, podiatry. Each punch is individually sealed in a peel-apart see-through package.

Standard	With plunger	BIOPSY PUNCHES	Blade length mm	Minimum order
22610	22630	Biopsy Punches Ø 1 mm	7	box of 20
22611	22631	Biopsy Punches Ø 1.5 mm	7	box of 20
22612	22632	Biopsy Punches Ø 2 mm	7	box of 20
22613	-	Biopsy Punches Ø 2.5 mm	7	box of 20
22614	22634	Biopsy Punches Ø 3 mm	7	box of 20
22615	-	Biopsy Punches Ø 3.5 mm	7	box of 20
22616	22636	Biopsy Punches Ø 4 mm	7	box of 20
22617	-	Biopsy Punches Ø 5 mm	7	box of 20
22618	-	Biopsy Punches Ø 6 mm	7	box of 20
22619	-	Biopsy Punches Ø 8 mm	7	box of 20



Seamless Stainless Steel Cutting Edge
Ensures a consistently smooth cutting surface, allowing optimal specimen quality



Internal Plunger System
Ejects lodged skin specimen inside the metal lumen of the punch



Punches are individually packed in a transparent, sturdy, blister pack in a 20 punches dispenser box
Multilanguage (GB, FR, DE, ES, PT, JP)
Made in Japan



SURGICAL PREP USE RAZORS



code	NON STERILE DISPOSABLE RAZORS stainless steel blades	Blade length	Minimum order
27080	Single blade - 98.6x41 mm	35 mm	box of 100
27081	Double blade - 98.6x41 mm	35 mm	box of 100
27082	Single blade with comb - 103x47 mm	38 mm	box of 50

SURGICAL CLIPPER

• 27085 SURGICAL CLIPPER

Battery operated surgical clipper for removing body hair from patients in preparation for surgery or other procedures requiring hair removal. Blade not included. Battery 2 x AA 1.5V not included.

• 27087 CLIPPER BLADE ASSEMBLY - sterile - box of 10 pcs

Disposable use for each patient. Single use blade assembly EO sterilized.



ISO 13485

FOLEY CATHETERS - LATEX

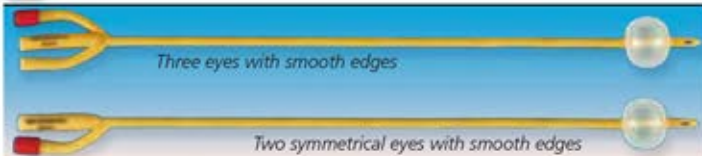

code	LATEX STERILE 100% SILICONE COATED FOLEY CATHETERS - SINGLE USE	Minimum order
Two-way catheters - balloon 5-10 ml - length 40 cm - soft valve		
22054	2-way Foley catheter ch/fr 12 - balloon 5-10 ml	box of 10
22055	2-way Foley catheter ch/fr 14 - balloon 5-10 ml	box of 10
22056	2-way Foley catheter ch/fr 16 - balloon 5-10 ml	box of 10
22057	2-way Foley catheter ch/fr 18 - balloon 5-10 ml	box of 10
22058	2-way Foley catheter ch/fr 20 - balloon 5-10 ml	box of 10
22059	2-way Foley catheter ch/fr 22 - balloon 5-10 ml	box of 10

Ball 5-10 ml means that the ball could be from 5 ml to 10 ml

code	LATEX STERILE 100% SILICONE COATED FOLEY CATHETERS - SINGLE USE	Minimum order
Two-ways catheters - balloon 30 ml - length 40 cm - soft valve		
22064	2-way Foley catheter ch/fr 12 - balloon 30 ml	box of 50
22065	2-way Foley catheter ch/fr 14 - balloon 30 ml	box of 50
22066	2-way Foley catheter ch/fr 16 - balloon 30 ml	box of 50
22067	2-way Foley catheter ch/fr 18 - balloon 30 ml	box of 50
22068	2-way Foley catheter ch/fr 20 - balloon 30 ml	box of 50
22069	2-way Foley catheter ch/fr 22 - balloon 30 ml	box of 50
22070	2-way Foley catheter ch/fr 24 - balloon 30 ml	box of 50
Three-ways catheters - balloon 30 ml - length 40 cm - soft valve		
22077	3-way Foley catheter ch/fr 18 - balloon 30 ml	box of 50
22078	3-way Foley catheter ch/fr 20 - balloon 30 ml	box of 50
22079	3-way Foley catheter ch/fr 22 - balloon 30 ml	box of 50
22080	3-way Foley catheter ch/fr 24 - balloon 30 ml	box of 50

RECTAL CATHETERS



code	PVC STERILE RECTAL CATHETERS length: 38 cm - with conical adapter	Minimum order
22169	Rectal catheters ch/fr 22 - purple	box of 100
22170	Rectal catheters ch/fr 24 - dark blue	box of 100
22171	Rectal catheters ch/fr 26 - white	box of 100
22172	Rectal catheters ch/fr 28 - green	box of 100
22173	Rectal catheters ch/fr 30 - grey	box of 100

FEEDING TUBES



code	PVC DEHP FREE* STERILE FEEDING TUBES length: 50 cm - with Luer fitting and sealing plug adapter	Minimum order
22150	Feeding tube ch/fr 5 - grey	box of 100
22151	Feeding tube ch/fr 6 - light green	box of 100
22152	Feeding tube ch/fr 8 - light blue	box of 100
22153	Feeding tube ch/fr 10 - black	box of 100

STOMACH TUBES

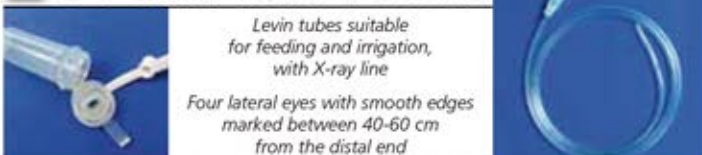

code	PVC DEHP FREE* STERILE STOMACH TUBES length: 110 cm - with multi functional adapter	Minimum order
22156	Stomach tube ch/fr 12	box of 100
22157	Stomach tube ch/fr 14	box of 100
22158	Stomach tube ch/fr 16	box of 100

FOLEY CATHETERS - SILICONE



code	100% SILICONE STERILE FOLEY CATHETERS - SINGLE USE	Minimum order
Two-way catheters - balloon 30 ml - length 40 cm		
22096	2-way Foley catheter ch/fr 16 - balloon 30 ml	box of 10
22097	2-way Foley catheter ch/fr 18 - balloon 30 ml	box of 10
22098	2-way Foley catheter ch/fr 20 - balloon 30 ml	box of 10
22099	2-way Foley catheter ch/fr 22 - balloon 30 ml	box of 10
22100	2-way Foley catheter ch/fr 24 - balloon 30 ml	box of 10

NELATON CATHETERS



code	PVC DEHP FREE* STERILE NELATON CATHETERS two lateral eyes with smooth edges Single use	Minimum order
MALE - length 38 cm		
22003	Male Nelaton catheter ch/fr 10 - black	box of 100
22004	Male Nelaton catheter ch/fr 12 - white	box of 100
22005	Male Nelaton catheter ch/fr 14 - dark green	box of 100
22006	Male Nelaton catheter ch/fr 16 - orange	box of 100
22007	Male Nelaton catheter ch/fr 18 - red	box of 100
FEMALE - length 18 cm		
22022	Female Nelaton catheter ch/fr 8 - light blue	box of 100
22023	Female Nelaton catheter ch/fr 10 - black	box of 100
22024	Female Nelaton catheter ch/fr 12 - white	box of 100
22025	Female Nelaton catheter ch/fr 14 - dark green	box of 100
22026	Female Nelaton catheter ch/fr 16 - orange	box of 100

SUCTION CATHETERS



Length	PVC DEHP FREE* STERILE SUCTION CATHETERS with conical adapter	Minimum order	
50 cm	22110	Suction catheter ch/fr 6 - light green	box of 100
90 cm	22120	Suction catheter ch/fr 8 - light blue	box of 100
	22112	Suction catheter ch/fr 10 - black	box of 100
	22122	Suction catheter ch/fr 12 - white	box of 100
	22113	Suction catheter ch/fr 14 - dark green	box of 100
	22123	Suction catheter ch/fr 16 - orange	box of 100
	22114	Suction catheter ch/fr 18 - red	box of 100
	22124	Suction catheter ch/fr 20 - yellow	box of 100
	22115	Suction catheter ch/fr 6 - light green	box of 100
	22125	Suction catheter ch/fr 8 - light blue	box of 100
	22116	Suction catheter ch/fr 10 - black	box of 100
	-	Suction catheter ch/fr 12 - white	box of 100
	-	Suction catheter ch/fr 14 - dark green	box of 100
	-	Suction catheter ch/fr 16 - orange	box of 100
	-	Suction catheter ch/fr 18 - red	box of 100
	-	Suction catheter ch/fr 20 - yellow	box of 100

CATHETER LUBRICANT GEL - STERILE

• 22104 CATHETER LUBRICANT GEL 12 ml - sterile - box of 25
Sterile, clear, water soluble gel used before applying catheter, cystoscope or other medical instrument to urethra.
It covers urethra generating a slick layer between urethral mucosa and catheter or medical instrument. It has antiseptic effect protecting patient from potential infection risk.
It contains Lidocaine 2%, chlorhexidine 0.05%.

22104

URINE BAGS - MADE IN SPAIN



Standard urine bag
(tube 90 or 130 cm)

Urine bag
with non return valve
(tube 90 or 130 cm)

code	URINE BAGS	Minimum order
STANDARD URINE BAGS		
28690	Urine bag 2000 cc - tube 90 cm - polybag	box of 30*
28688	Urine bag 2000 cc - tube 90 cm - bulk	box of 250
28692	Urine bag 2000 cc - tube 130 cm - polybag	box of 30*
28689	Urine bag 2000 cc - tube 130 cm - bulk	box of 200
*Polybag of 30 bags with tips (Italian reimbursement label) and 1 hanger		

URINE BAGS WITH NON RETURN VALVE		
28691	Urine bag 2000 cc - tube 90 cm - polybag	box of 30*
28694	Urine bag 2000 cc - tube 90 cm - bulk	box of 250
28693	Urine bag 2000 cc - tube 130 cm - polybag	box of 30*
28695	Urine bag 2000 cc - tube 130 cm - bulk	box of 200
*Polybag of 30 bags with tips (Italian reimbursement label) and 1 hanger		

URINE LEG BAGS WITH NON RETURN VALVE		
28707	Urine leg bag 750 cc - tube 10 cm - polybag complete with push pull outlet device	box of 30**
28708	Urine leg bag 750 cc - tube 35 cm - polybag complete with push pull outlet device	box of 30**
**Polybag of 30 bags with 1 set of button straps		

Instructions in GB, FR, IT, ES, DE, PT, GR, PL. Non sterile.
Tube Ø: internal 5.05 mm, external 6.35 mm. Latex and DEHP free.



Tips available for 28690/11/2/3 and 28707/8

code	HANGER HOLDER FOR URINE BAGS	Minimum order
28699	Hanger holder for urine bag - blue - bulk	box of 200

code	EXTERNAL LATEX CATHETERS	Minimum order
28710	Men external catheter Ø 30 mm - latex	box of 30
28711	Men external catheter Ø 35 mm - latex	box of 30
28715	Biadhesive tape 2x15x0.5 cm	box of 30

External catheters with knurled cap to avoid drainage system to twist on itself

STERILE PAEDIATRIC URINE BAG FOR BOY AND GIRL



• 28685 PAEDIATRIC URINE BAG 100 ml - sterile - box of 100
Paediatric urine bag, individually wrapped in polybag. They can be used for boy and girl. Graduated 10 to 100 ml, sterile.



TRAVELJOHN™ RESEALABLE DISPOSABLE URINAL AND VOMIT BAG



• 25880 TRAVELJOHN™ DISPOSABLE URINAL 800 cc - box of 3
• 25885 TRAVELJOHN™ DISPOSABLE URINAL 600 cc - bag of 10
- practical super absorbent polymer pouch that instantly turns urine to gel
- no closure needed
- reusable until it is full
- waste disposal safe, simply throw away unisex plastic collar for easy handling
• 25887 TRAVELJOHN™ DISPOSABLE VOMIT BAG 800 cc - box of 5
- gels instantly and water proof
- convenient sanitary and compact
- odourless and waste disposal safe



Puncture resistant, spill and leak proof
Polymer pouch
Peel and seal after use

URINE CONTAINERS



Graduated urine containers made in polypropylene with red screw cap and frosted label.
One multilanguage instruction in each carton: GB, FR, IT, ES, PT.

code	URINE CONTAINERS - BULK	Minimum order
25958	Urine containers 120 ml	box of 300
URINE CONTAINERS - individually wrapped		
25960	Urine containers 60 ml - cleanroom ISO8	box of 500
25961	Urine containers 60 ml - sterile	box of 500
25962	Urine containers 120 ml - cleanroom ISO8	box of 250
25963	Urine containers 120 ml - sterile	box of 250

BIOLOGICAL COLLECTORS

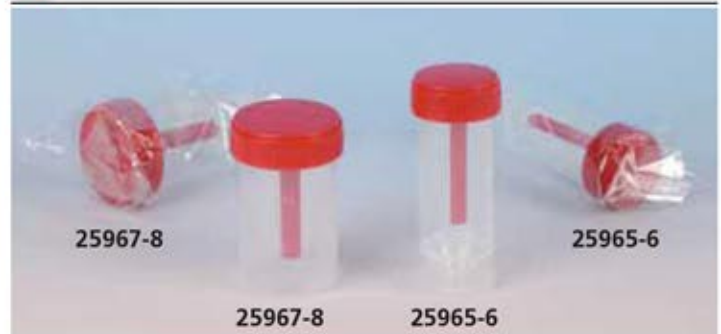

Coprotainer® graduated faeces containers made in polypropylene with red screw cap and frosted label, individually wrapped.
One multilanguage instruction in each carton: GB, FR, IT, ES, PT.

code	BIOLOGICAL CONTAINERS	Minimum order
25965	Faeces container 30 ml - cleanroom ISO8	box of 500
25966	Faeces container 30 ml - sterile	box of 500
25967	Faeces container 60 ml - cleanroom ISO8	box of 500
25968	Faeces container 60 ml - sterile	box of 500

24 HOURS URINE CONTAINERS



All containers are individually wrapped

24 h graduated urine containers made in polyethylene.
One multilanguage instruction in each carton: GB, FR, IT, ES, PT.

code	24 h URINE CONTAINERS	Minimum order
25980	Bottle 2500 ml	box of 30
25981	Container 2000 ml with ergonomic handle	box of 54
25982	Tank 2500 ml	box of 30

PLASTIC BED PAN - URINAL



• **25979 PLASTIC BED PAN** - box of 20
Made in polypropylene and individually wrapped.
• **25978 MEN PLASTIC URINAL**, 1,000 ml - box of 60
Made in polyethylene and individually wrapped.
Bed pan and plastic urinal have multilanguage polybag: GB, FR, IT, ES, PT, PL, GR, SE.

CONTAINERS IN SINGLE BOX - PHARMACY LINE



Graduated, sterile urine and faeces containers
Individually wrapped sterile containers with paper label (25987) or frosted label (25969, 25997) and screw cap in single box.

Graduated 24 h urine tank

Polyethylene urine tank for 24 hour urine collection, in single box

Sterile urine test tube

Individually wrapped urine test tube with paper label in single box. Graduated 0.5, 1, 2.5, 5, 10 ml.

All products have multilanguage box: GB, FR, IT, ES.

code	CONTAINERS	Material	Minimum order
25987	Urine container 120 ml - red cap	Polypropylene	box of 100
25969	Urine container 120 ml - yellow cap	Polypropylene	box of 100
25990	Urine test tube 12 ml	Polystyrene	box of 100
25995	Urine tank 24 h 2500 ml	Polyethylene	box of 27
25997	Faeces container 60 ml	Polypropylene	box of 100

PLASTIC HOLLOWARE - AUTOCLAVABLE 135°C



All gallipots and kidney dishes are graduated

AUTOCLAVABLE AT 135°C

PLASTIC HOLLOWARE - autoclavable hundreds of times For the protection and delivery of sterile instruments to operating rooms. For the administration of procedures, holding cleansing solutions and the administration of medicines and fluids.

4 good reasons to choose plastic line:

- 50% cheaper than stainless steel equivalent
- autoclavable at 135°C with no limits
- attractive modern design
- lighter than equivalent stainless steel

All products are manufactured from polypropylene material that is easy to clean, resistant to most healthcare chemicals.

- 26630 GALLIPOT/LOTION BOWL 60x40 mm - graduated 50 ml
- 26631 GALLIPOT/LOTION BOWL 80x60 mm - graduated 200 ml
- 26632 GALLIPOT/LOTION BOWL 100x45 mm - graduated 300 ml
- 26633 GALLIPOT/LOTION BOWL 150x70 mm - graduated 500 ml
- 26635 KIDNEY DISH 200x45 mm - graduated 500 ml
- 26636 KIDNEY DISH 250x55 mm - graduated 750 ml with special nodules on rim to prevent vacuum during autoclaving
- 26638 INSTRUMENT TRAY 200x150x51 mm
- 26639 INSTRUMENT TRAY 300x250x52 mm
- 26640 COMPARTMENT TRAY 270x180x41 mm



26640

VALUE PLASTIC HOLLOWARE - AUTOCLAVABLE 134°C

Economic line of reusable plasticware products.

Made in polypropylene, easy to clean and resistant to most

healthcare chemicals. Autoclavable at 121°C (15 min), 126°C (10 min) or 134°C (3 min).



- 37701 GALLIPOT 63x42 mm - 90 ml
- 37702 GALLIPOT 90x60 mm - 240 ml



- 37705 KIDNEY TRAY 6" 155x75 mm
- 37706 KIDNEY TRAY 8" 205x100 mm
- 37707 KIDNEY TRAY 10" 260x125 mm
- 37708 KIDNEY TRAY 12" 306x140 mm



- 37710 MEASURING JUG 500 ml
 - 37711 MEASURING JUG 1,000 ml
 - 37712 MEASURING JUG 2,000 ml
- Raised graduation for easy reading.



- 37715 LABORATORY TRAY 375x300xh 75 mm



- 37717 COMPARTMENT TRAY 266x175xh 42 mm



Provided with cover which fits into groove of the tray to avoid minimum spillage of material.

- 37718 INSTRUMENT TRAY 220x150xh 70 mm

POLYSTYRENE TEST TUBES - GRADUATED



code	POLYSTYRENE TEST TUBES	Minimum order
37902	12x75 mm - 5 ml cylindrical, no rim	box of 4,000*
37903	13x75 mm - 5 ml cylindrical, no rim	box of 4,000*
37912	16x100 mm - 10 ml cylindrical, with rim	box of 2,000
37913	16x100 mm - 10 ml conical, with rim	box of 2,000

*16 bags of 250 pcs

WINGED STOPPERS FOR TEST TUBES

37930	Stopper for tubes Ø 12 mm	box of 1,000
37931	Stopper for tubes Ø 13 mm	box of 1,000
37932	Stopper for tubes Ø 16 mm	box of 1,000



Stoppers in polyethylene, neutral colour

PASTEUR PIPETTES

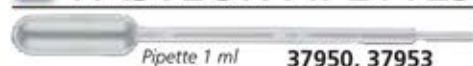

Pipette 1 ml 37950, 37953



Pipette 3 ml 37951, 37954



37953, 37954

Made of polyethylene, individually wrapped in peel pack

code	PASTEUR PIPETTE	Minimum order
37950	Pipette 1 ml	box of 5,000*
37951	Pipette 3 ml	box of 5,000*
37953	Pipette 1 ml - sterile	box of 1,000
37954	Pipette 3 ml - sterile	box of 1,000

*10 boxes of 500 pieces

ALUMINIUM STERILIZATION CONTAINER SYSTEM



Standard containers (supplied with 1 paper filter)

All containers are autoclavable at maximum 134°C, 2.2 bar

Barrier system containers

STANDARD CONTAINER WITH FILTER* Not for sale in Germany			
LID COLOUR	Grey	Red	Blue
Height mm	[NON PERFORATED BOTTOM]		[PERFORATED BOTTOM]
		SMALL 285x280 mm	
	1 filter		2 filter
100	37000	37010	37030
135	37001	-	37031
150	37002	37012	37032
200	37003	-	37033
260	37004	-	-
	MEDIUM 465x280 mm		
	1 filter		2 filter
100	37050	37060	37080
135	37051	-	37081
150	37052	37062	37082
200	37053	-	37083
	LARGE 580x280 mm		
	2 filter		4 filter
100	37100	37110	37130
135	37101	-	37131
150	37102	37112	37132
200	37103	-	37133
260	37104	-	-

*Perforated bottom allows much quicker sterilization process (half time than with not perforated).

BARRIER SYSTEM CONTAINER WITH VALVE** Not for sale in Germany			
LID COLOUR	Grey	Red	Blue
Height mm	[NON PERFORATED BOTTOM]		[PERFORATED BOTTOM]
		SMALL 285x280 mm	
100	37150	37160	37180
135	37151	-	37181
150	37152	37162	37182
200	37153	-	37183
260	37154	-	-
	MEDIUM 465x280 mm		
100	37200	37210	37240
135	37201	-	37241
150	37202	37212	37242
200	37203	-	37243
	LARGE 580x280 mm		
100	37250	37260	37280
135	37251	-	37281
150	37252	37262	37282
200	37253	-	37283
260	37254	-	-

**This system is preferred when is requested continuous use of containers, it avoids filter replacement. Valve opens during sterilization to allow exit of steam.



WIRE BASKET - stainless steel			
Size mm	Height		
	50 mm*	70 mm**	100 mm***
255x245	37301	37302	37303
405x255	37306	37307	37308
540x255	37311	37312	37313

*Suggested for container with height 100/135 mm

** Suggested for container with height 135/150 mm

*** Suggested for container with height >150 mm

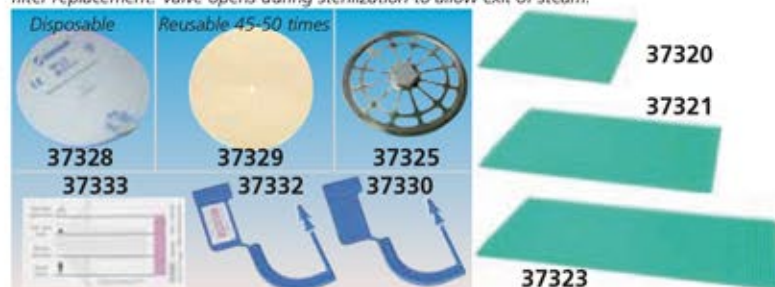
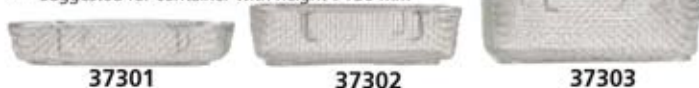

code	ACCESSORIES
37320	Silicone mat 220x230 mm - perforated - small
37321	Silicone mat 380x230 mm - perforated - medium
37322	Silicone mat 520x230 mm - perforated - large
37325	S/S Filter holder for paper/textile Ø 18 cm
37328	Disposable Paper filter Ø 18.6 cm with steam indicator - box of 100
37329	Reusable Textile* filter Ø 20.5 cm - standard container
37330	Plastic security seal - box of 100
37332	Plastic security seal with steam indicator - box of 100
37333	Container card with steam indicator 68x37.5 mm - box of 250

*Long term textile filters can be used for 45-50 sterilizations

ALUMINIUM BOXES

- 26662 ALUMINIUM BOX 17.5x7.6xh 2 cm
 - 26663 ALUMINIUM BOX 18.5x9.5xh 3 cm
 - 26664 ALUMINIUM BOX 21.8x10.6xh 3 cm
 - 26665 ALUMINIUM BOX 21.8x10.6xh 5 cm
- Useful containers for the sterilization of surgical instruments and to maintain them sterile. Silicone tray not included.
Nice aluminium box with blue base and silver cover.
- 26672 SILICONE TRAY 20x10 cm (for 26669, 26664, 26665)

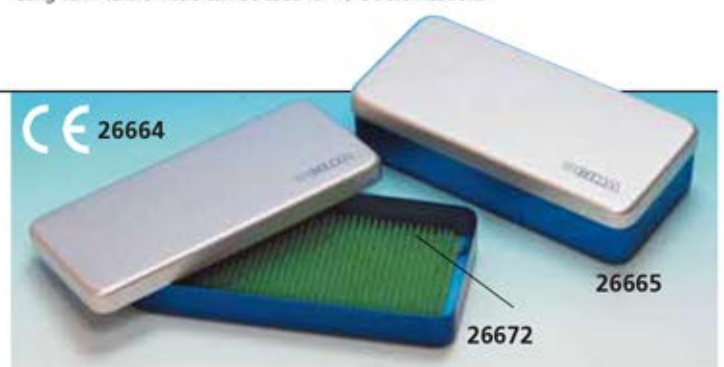

ROUND STERILIZER DRUMS - STAINLESS STEEL AISI 304



code	STERILIZER DRUMS	GIMA code	STERILIZER DRUMS
26673	Ø 120x h 120 mm	26682	Ø 240x h 240 mm
26675	Ø 150x h 100 mm	26683	Ø 290x h 160 mm
26674	Ø 150x h 150 mm	26684	Ø 290x h 240 mm
26676	Ø 165x h 120 mm	26687	Ø 290x h 290 mm
26678	Ø 180x h 180 mm	26689	Ø 340x h 180 mm
26680	Ø 190x h 160 mm	26688	Ø 340x h 240 mm
26677	Ø 190x h 240 mm	26685	Ø 340x h 340 mm
26681	Ø 240x h 160 mm	26686	Ø 390x h 250 mm
26679	Ø 240x h 190 mm		

ROUND STERILIZER DRUMS for autoclave and hot air sterilizer. Cylindrical containers used to sterilize dressing materials (gauze compress or cotton etc.) in a steam sterilizer (autoclave) or hot air sterilizer and to keep them as "sterile". Drums have an effective closing lid with a clip lock system, a carrying handle, air vents system to allow steam to circulate freely during the sterilization cycle/process. Easy to operate lateral air vent system to be manually closed after sterilization.

STAINLESS STEEL BOXES WITH OR WITHOUT HANDLE



STAINLESS STEEL BOXES - Autoclavable 125°C

- 26653 STAINLESS STEEL BOX 18x8xh 4 cm
- 26654 STAINLESS STEEL BOX 20x10xh 6 cm
- 26655 STAINLESS STEEL BOX 25x12xh 6 cm
- 26656 STAINLESS STEEL BOX 30x15xh 6 cm
- 26657 STAINLESS STEEL BOX 50x20xh 10 cm
- 26672 RUBBER TRAY 20x10 cm for 26654



STAINLESS STEEL BOXES WITH HANDLES - Autoclavable 125°C

- 26668 STAINLESS STEEL BOX 18x8xh 4 cm
- 26669 STAINLESS STEEL BOX 20x10xh 4.5 cm
- 26670 STAINLESS STEEL BOX 25x12.5xh 4.5 cm
- 26671 STAINLESS STEEL BOX 30x15xh 6 cm
- 26667 STAINLESS STEEL BOX 50x20xh 10 cm
- 26672 RUBBER TRAY 20x10 cm for 26669

BUCKETS WITH LID - STAINLESS STEEL

- 26576 BUCKET WITH LID 12 l - 290x300 mm
- 26577 BUCKET WITH LID 15 l - 322x307 mm

Stainless Steel AISI 304 buckets autoclavable at 121°C.



DISPOSABLE KIDNEY DISH



Size: 252x150x46 mm

26645

• **26645 DISPOSABLE KIDNEY DISH** - box of 300 pcs
Safe, clean, easy to use, atoxic and latex free.
Suitable for medical use.

TECHNICAL SPECIFICATIONS

Material:	moulded paper pulp
Resistance:	36 hours to water, 4 hours to organic liquids
Maximum capacity:	about 750 ml
Disposal:	biodegradable and compostable
Medical device:	93/42 CE - Class I non sterile

S/S KIDNEY DISHES - AUTOCLAVABLE 121°C

Kidney dishes have curved edges

26642



26641



26643



26644



ECONOMIC S/S KIDNEY DISHES

S/S Kidney dishes, autoclavable 121°C, with 0.5 mm thickness

code	ECONOMIC S/S KIDNEY DISHES	Capacity
26641	Tray 6" - 162x77x31 mm	190 ml
26642	Tray 8" - 207x98x39 mm	400 ml
26643	Tray 10" - 247x122x43 mm	600 ml
26644	Tray 12" - 309x149x59 mm	1500 ml

S/S AISI 304 - 18/8 KIDNEY DISHES - THICKNESS 0.6 MM - AUTOCLAVABLE 121°C



Flat edges

26610

Flat edges

26611

26612

Curved edges



26580

26581

26582

Curved edges



26584

26585

26589

Curved edges

code	SHALLOW KIDNEY DISHES	Capacity
26610	Tray 8" - 207x128xh 33 mm	480 ml
26611	Tray 10" - 254x141xh 33 mm	750 ml
26612	Tray 12" - 280x141xh 40 mm	1600 ml

code	DEEP KIDNEY DISHES	Capacity
26580	Tray 6" - 162x77x31 mm	190 ml
26581	Tray 8" - 207x98x39 mm	400 ml
26582	Tray 10" - 247x122x43 mm	600 ml
26583	Tray 12" - 309x149x59 mm	1500 ml

code	DEEP WITH COVER* KIDNEY DISHES	Capacity
26584	Tray 7" - 200x95x35 mm	300 ml
26585	Tray 10" - 247x122x43 mm	600 ml
26589	Tray 12" - 309x149x59 mm	1500 ml

*Thickness of cover 0.5 mm

S/S AISI 304 - 18/8 WASH BASINS AND GALLIPOTS - AUTOCLAVABLE 121°C



26586

26587



26621

26622



26618

26619

26616

26617

code	WASH BASINS	Capacity
26586	Ø 310x h 72 mm - shallow	3 l
26588	Ø 405x h 95 mm - shallow	7 l
26587	Ø 318x h 84 mm - deep	4 l

code	ROUND GALLIPOTS	Capacity
26595	Ø 107xh 56 mm	325 ml
26596	Ø 158xh 75 mm	940 ml
26621	Ø 208xh 84 mm	1940 ml
26622	Ø 258xh 92 mm	3200 ml

code	GALLIPOTS WITH LIP	Capacity
26616	Ø 56xh 32 mm	50 ml
26617	Ø 88xh 46 mm	170 ml
26618	Ø 128xh 60 mm	450 ml
26619	Ø 158xh 75 mm	940 ml

STAINLESS STEEL HOLLOWARE - AUTOCLAVABLE 121°C - AISI 304



STAINLESS STEEL HOLLOWARE
Stainless steel AISI 304 holloware with minimum thickness 0.6 mm. Autoclavable at 121°C.

INSTRUMENT TRAYS - ANGLED EDGES	
Without cover	
26603	306x196x h 50 mm
26604	355x254x h 50 mm
26597	380x304x h 50 mm
26598	440x320x h 64 mm
With cover	
26607	306x196x h 50 mm
26608	355x254x h 50 mm
26609	440x320x h 64 mm



INSTRUMENT TRAYS ROUND EDGES	
Without cover	
26599	223x126x h 45 mm
26602	264x172x h 47 mm
With cover	
26605	223x126x h 45 mm
26606	264x172x h 47 mm

DENTAL TRAY	
26600	208x109x h 15 mm
INSTRUMENT TRAYS	
26601	210x160x h 25 mm
26629	313x218x h 31 mm

MAYO TRAYS - SHALLOW	
26613	254x165x h 18 mm
26614	350x252x h 16 mm
26615	432x295x h 19 mm



• 26592 BED PAN ROUND WITH COVER - 320x85 mm

DRESSING JAR WITH LID
• 26623 DRESSING JAR - 0.5 l - Ø 102x65 mm
• 26624 DRESSING JAR - 1 l - Ø 103x126 mm
• 26625 DRESSING JAR - 2 l - Ø 127x161 mm

• 26626 FORCEPS JAR - Ø 55xh 140 mm
• 26627 FORCEPS JAR - Ø 55xh 180 mm
• 26628 THERMOMETER JAR - Ø 33xh 80 mm



• 26590 BED PAN FRACTURE TYPE - with ring - 418x292x85 mm

• 26594 BED PAN FRACTURE TYPE - with tube handle - 418x292x85 mm

• 26593 BED PAN PERFECTION TYPE 354x289x97 mm



• 26578 MALE URINAL - 1.2 l

• 26579 FEMALE URINAL - 1.2 l

• 26591 MALE VERTICAL URINAL Ø 114x220 mm - 1.5 l

HYPODERMIC SYRINGES IN 3 PARTS WITH AND WITHOUT NEEDLE

High-quality range of medical devices ensuring an optimal safety. The range of Hypodermic syringe INJ/LIGHT have been manufactured in compliance with the most important international standards in conformity with European Directive 93/42/EEC and with UNI EN ISO 9001/2000 - UNI EN ISO 13485/2004.

The INJ/LIGHT line is completely non-toxic and non-pyrogenic, made of transparent polypropylene with graduated black colour scale and individually packed in blister pack. Box in GB, FR, IT, ES, DE, PT, GR, RO, RU, YU, SA.

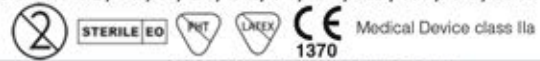

SYRINGE WITHOUT NEEDLE		
code	Capacity	Minimum order
LUER LOCK CONE		
23808	10 ml	box of 100
23809	20 ml	box of 50
23810	30 ml	box of 50
23811	60 ml	box of 25
CENTRIC LUER CONE		
23813	3 ml	box of 100
23814	5 ml	box of 100
23815	10 ml	box of 100
ECCENTRIC LUER CONE		
23816	10 ml	box of 100
23817	20 ml	box of 50
23819	60 ml	box of 25
CATHETER CONE		
23820	60 ml	box of 20
23821	100 ml	box of 25

SYRINGE WITH NEEDLE			
code	Capacity	Assembled needle	Minimum order
CENTRIC LUER CONE			
23822	1 ml - tuberculin	26G - 0.45x12.7 mm	box of 100
23824	2.5 ml*	21G - 0.8x38 mm	box of 100
23825	2.5 ml*	22G - 0.7x32 mm	box of 100
23827	5 ml	21G - 0.8x38 mm	box of 100
23828	5 ml	22G - 0.7x32 mm	box of 100
23830	10 ml	21G - 0.8x38 mm	box of 100
*Extended scale: 3 ml			
ECCENTRIC LUER CONE			
23833	10 ml	21G - 0.8x38 mm	box of 100
23834	20 ml	21G - 0.8x38 mm	box of 50

Needle in AISI 304 stainless steel triple bevelling



HYPODERMIC NEEDLES AND SCALP-VEIN SETS - STERILE

A line of hypodermic needles and scalp vein sets ensuring minimal trauma during penetration thanks to the triple bevelling. Each element of the needle is treated for painless injection.

The needles are in stainless steel AISI 304 with triple bevelling and totally non-toxic

23785



HYPODERMIC NEEDLES				
Standard	Safety	Needle	Colour	Minimum order
23750	23780	18G - 1.2x38 mm	Pink	box of 100 (standard needles)
23751	23781	19G - 1.1x38 mm	Cream	
23753	-	20G - 0.9x38 mm	Yellow	
23755	23785	21G - 0.8x38 mm	Green	box of 50 (safety needles)
23757	-	22G - 0.7x32 mm	Black	
23758	23788	23G - 0.6x25 mm	Turquoise	
23760	-	25G - 0.5x16 mm	Orange	
23761	-	26G - 0.45x12.7 mm	Brown	
23762	-	27G - 0.4x12.7 mm	Grey	

and non-pyrogenic. Needles have Luer-slip cone, can be mounted on syringes with Luer-slip or Luer-lock. The scalp vein set needles are provided with soft flexible grained wings. The tube is made of 30 cm PVC with luer-lock. Individually packaged in blister. Box and instructions: GB, FR, IT, DE, ES, PT, GR, RU (Scalp-vein sets) GB, IT, ES, PT (Hypodermic needles).



SCALP - VEIN SETS				
Standard	Safety	Needle	Colour	Minimum order
23766	-	19G - 1.1x19 mm	Cream	box of 100
23767	-	20G - 0.9x19 mm	Yellow	box of 100
23768	23774	21G - 0.8x19 mm	Green	box of 100
23769	-	22G - 0.7x19 mm	Black	box of 100
23770	23776	23G - 0.6x19 mm	Turquoise	box of 100
23771	-	25G - 0.5x19 mm	Orange	box of 100

5 ml SYRINGE - RETAIL BOX

• 23795 SYRINGE 5 ml
With needle 23G 0.60x25 mm.
Sterile, packed in single blister.
Box of 10 syringes.
Minimum order:
carton of 12 boxes of 10 syringes



5 ml SAFETY SYRINGE - RETAIL

• 23796 SAFETY SYRINGE 5 ml
With needle 23G 0.60x25 mm.
Sterile, packed in single blister.
Box of 5 syringes.
Minimum order:
carton of 48 boxes of 5 syringes

STOP ACCIDENTAL NEEDLE STICKS



BD EMERALD™ SYRINGES

Minimizes Waste Disposal
Has up to 30% less material than other syringes

Flange Size and Shape
To provide stability and comfort during use

Textured Thumb Press
To reduce slippage during administration

CE 0318

Green Stopper and Bold Scale Markings
To aid in setting an accurate dose

Clear Barrel
To allow for visualization of fluid

Robust Retaining Ring
To help prevent accidental plunger rod pullout

BD EMERALD™ SYRINGES				
code	BD code	Capacity	NEEDLE	Minimum order
SYRINGES WITHOUT NEEDLES - LUER SLIP CENTRIC TIP				
23863	307727	2 ml		box of 100
23864	307731	5 ml		box of 100
23865	307736	10 ml		box of 100
SYRINGES WITH NEEDLES - LUER SLIP CENTRIC TIP				
23868	307728	2 ml	22G - 0.7x30 mm	box of 100
23869	307733	5 ml	22G - 0.7x30 mm	box of 100
23870	307737	10 ml	21G - 0.8x40 mm	box of 100

BD PLASTIPAK™ SYRINGES

CE 0050

23873



23878

BD PLASTIPAK™ SYRINGES				
code	BD code	Capacity	MODEL	Minimum order
SYRINGES WITHOUT NEEDLE - LUER LOCK				
23873	301229	30 ml	Luer - lock	box of 60
23874	300865	50 ml	Luer - lock	box of 60
SYRINGES WITHOUT NEEDLE - CATHETER CONE				
23877	300867	50 ml	Catheter cone	box of 60
23878	300605	100 ml	Catheter cone	box of 25

BD MICROLANCE™ NEEDLES

code	BD code	BD MICROLANCE™ NEEDLES	Minimum order
23739	304622	18G - 1.20x40 mm - pink	box of 100
23740	301500	19G - 1.10x40 mm - white	box of 100
23741	301300	20G - 0.90x40 mm - yellow	box of 100
23742	304432	21G - 0.80x40 mm - green	box of 100
23743	300900	22G - 0.70x30 mm - black	box of 100
23744	300800	23G - 0.60x25 mm - blue	box of 100
23745	300600	25G - 0.50x16 mm - orange	box of 100
23746	303800	26G - 0.45x13 mm - brown	box of 100
23747	300635	27G - 0.40x13 mm - grey	box of 100
23748	304000	30G - 0.29x13 mm - yellow	box of 100



CE 0050



BD MICRO-FINE™ INSULIN NEEDLES AND SYRINGES

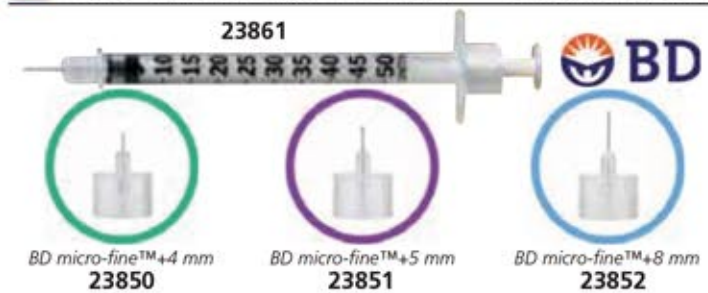

code	BD code	BD MICRO-FINE™ NEEDLES	Minimum order
23850	320140	BD Micro-Fine needles 4 mm - 32G	box of 100
23851	320594	BD Micro-Fine needles 5 mm - 31G	box of 100
23852	320592	BD Micro-Fine needles 8 mm - 31G	box of 100

Compatible with most of insulin pens available on the market (Sanofi-Aventis, Eli Lilly, Novo Nordisk, Owen Mumford)

BD MICRO-FINE™ SYRINGES			
code	BD code	BD Micro-Fine syringes	Minimum order
23860	324826	BD Micro-Fine syringes 0.3 ml - 8 mm - 30G	box of 100
23861	324825	BD Micro-Fine syringes 0.5 ml - 8 mm - 30G	box of 100

INSULIN SYRINGE INSU/LIGHT

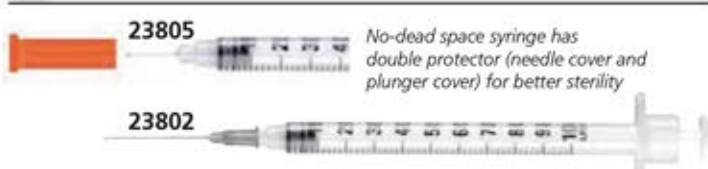

Available with assembled needle or fixed needle both with no-dead space. Insulin syringes with fixed needle have the needle directly fixed on the cone and have a double protection (needle cap and plunger cap), assuring the sterility of the device. Non-toxic and non-pyrogenic, made of transparent polypropylene with graduated insulin scale. Needle in stainless steel AISI 304 with triple bevelling.

code	INSULIN SYRINGE NO DEAD SPACE - ASSEMBLED NEEDLE	Minimum order
23802	Insulin syringe 1 ml - 25G - 0.5x16 mm	box of 100
INSULIN SYRINGE NO-DEAD SPACE		
23805	Insulin syringe 0.5 ml - 30G - 0.3x8 mm	box of 100

INSULIN PEN NEEDLES



Insulin Pen Needles are disposable, sterile needles used with insulin pens to control high blood sugar in adults and children with diabetes mellitus. With a fine design to minimize the discomfort of injection, ultra-thin needles provide painless and a non traumatic injection due to a silicone film. Pyrogen free.

code	GIMA INSULIN PEN NEEDLES - UNIVERSAL	Minimum order
23840	GIMA insulin pen needles 4 mm - 32G	box of 100
23841	GIMA insulin pen needles 5 mm - 31G	box of 100
23842	GIMA insulin pen needles 6 mm - 31G	box of 100
23843	GIMA insulin pen needles 8 mm - 31G	box of 100

Compatible with most of insulin pens available on the market (Sanofi-Aventis, Novo Nordisk, Eli Lilly, Owen Mumford)

MESO-RELLE MESOTHERAPY AND SCLEROTHERAPY NEEDLES



MESO-RELLE HYPODERMIC NEEDLES

Meso-relle disposable hypodermic needles are multiple sharpened to facilitate penetration. Stainless steel AISI 304 cannula and polypropylene connection for syringe. Sterilized with ethylene oxide. Sold in individual blister made of medical paper. Made in Italy.



meso-relle®

code	MESOTHERAPY LUER NEEDLES				Minimum order
	Gauge	Ø mm	Length mm	Colour	
23670	27G	0.40	4	grey	box of 100
23671	27G	0.40	6	grey	box of 100
23672	30G	0.30	4	yellow	box of 100
23673	30G	0.30	6	yellow	box of 100
23674	31G	0.26	4	light blue	box of 100
23676	32G	0.23	4	pink	box of 100
23678	33G	0.20	4	green	box of 100
SCLEROTHERAPY/FILLER LUER NEEDLES					
23680	30G	0.30	12	yellow	box of 100
23682	31G	0.26	12	light blue	box of 100
23684	32G	0.23	12	pink	box of 100

MICRO-MESOTHERAPY



MESO-RELLE MICRO-MESOTHERAPY

Microtherapy, an evolution from mesotherapy, is a recent technique for administration of drugs via superficial intraderma injection, and it is an additional technique to intramuscular intra-venereal and subcutaneous injections.



Single use device with the shape of a reversed cone with in its centre a special ultrafine needle

code	MICRO-MESOTHERAPY NEEDLES - STERILE					Minimum order
	Type	Gauge	Ø mm	Length mm	Colour	
23690	Needle	27G		2.5	white	box of 25
23691	Needle	30G		2.5	yellow	box of 25
23694	S.I.T.*	31G	0.26	2.5	white	box of 25

*Skin Injection Therapy

MESO-RELLE MULTI-INJECTORS



MESO-RELLE MULTI-INJECTOR CONNECTORS

Meso-relle disposable mesotherapy multi-injectors connectors are sterilized with ethylene oxide.

They are packed in individual, transparent blister, are colourless and transparent to enable full examination of the inner chamber and are perfectly resistant to high pressure.

code	MULTI-INJECTOR CONNECTORS			Minimum order
	Type	Way-out	Taper	
23700	Straight	3	Luer	box of 50
23701	Straight	5	Luer	box of 50
23703	Circular	5	Luer	box of 50

I.V. CATHETERS WITH STRAIGHT HUB OR SIDE PORT - STERILE

High flow rate thin wall kink-resistant polyurethane and FEP radiopaque catheters

Secure grip and intuitive handling ribbed housing and bevel-up indicator

Needle-in-vein aspiration removable flash plug

SAFETY STRAIGHT HUB CATHETER

Easy vein entry ultrasharp V-point introducer needle reduces penetration force by 25 to 30%

Patient comfort and secure fixation long hub for generous suturing or taping

Flast visualization translucent flash chamber



Conventional no protection	Safety	I.V. CATHETER WITH STRAIGHT HUB			Minimum order
		Gauge	Gauge mm	Colour	
23720	23725	18G	45 mm (1¾")	Green	box of 50
23721	23726	20G	32 mm (1¼")	Pink	box of 50
23722	23727	22G	25 mm (1")	Blue	box of 50

Conventional no protection	Safety	I.V. CATHETER WITH SIDE PORT			Minimum order
		Gauge	Gauge mm	Colour	
23730	23735	18G	45 mm (1¾")	Green	box of 50
23731	23736	20G	32 mm (1¼")	Pink	box of 50
23732	23737	22G	25 mm (1")	Blue	box of 50

BD VENFLON™ IV CATHETERS - STERILE

BD VENFLON™ IV CATHETERS

I.V. Cannula Luer-Lock with a plug attached to the flow control plug. Designed to gain access to peripheral veins of the patient's blood system for rehydration, parenteral nutrition, medication delivery, blood transfusion, and monitoring purposes.

Flash Back Function - During the insertion of the cannula, blood flow is visualized by blood flash back in the hub of the cannula



Multilanguage box and instructions



code	BD code	BD VENFLON™ I.V. CATHETERS				Minimum order
		Gauge	Gauge mm	Flow rate	Colour	
23715	391453	18G	45 mm (1¾")	80	Green	box of 50
23716	391452	20G	32 mm (1¼")	54	Pink	box of 50
23717	391451	22G	25 mm (1")	31	Blue	box of 50

23716



INFUSION SET

INFUSION SETS

Infusion set includes: ABS spike with air vent, PVC chamber PVC tube 150 cm, ABS roller, ABS luer lock terminal without needle, latex free injection site. Sterilized by Ethylene oxide.

- 26069 INFUSION SET - polybag - box of 500
- 26064 INFUSION SET - blister - box of 360 (18 box of 20)



INFUSION SET FOR PUMP

- 26073 ARIES I.V. INFUSION SET - box of 150 (6 bags of 25)

Infusion set for the administration of solution into the human body with pump.

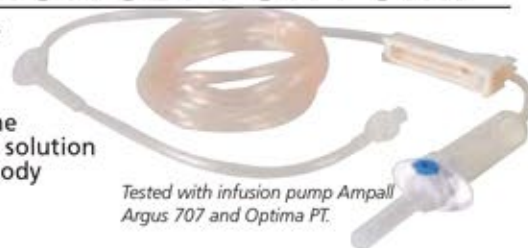

Tested with infusion pump Ampall Argus 707 and Optima PT.

NEEDLE-LESS VALVE

- 26059 NEEDLE-LESS VALVE - sterile - box of 500

Device for I.V. infusion and/or withdrawal, needle-less closed circuit. For protection of vascular access and of all infusion systems equipped with male luer-lock standard connections. This closed and self-sealing protection system allows to infuse or inject fluid, make withdrawals

Latex free
PVC free



eliminating the risk of accidental puncture to operators and reducing the risk of contamination to patients. Medical Device Class I.

26059



BD SPINAL NEEDLES

Single use latex free sterile BD quincke point spinal anesthesia needles. Multilanguage box and instructions.



CE 0318 23707

GIMA code	BD code	BD QUINCKE POINT SPINAL ANESTHESIA NEEDLE - STERILE	Minimum order
23705	405248	18G 3.50 IN 1.2x90 mm - pink	box of 25
23707	405253	20G 3.50 IN 0.9x90 mm - yellow	box of 25
23709	405256	22G 3.50 IN 0.7x90 mm - black	box of 25
23710	405240	23G 3.50 IN 0.64x90 mm - turquoise	box of 25
23711	405257	25G 3.50 IN 0.5x90 mm - orange	box of 25

MARGHERITA FINGERGUARD FOR HYPODERMIC NEEDLES



Internationally patented

23798

NO MORE ACCIDENTAL SYRINGE INJURIES

- 23798 MARGHERITA FINGERGUARD

Margherita is a Class I Medical Device that allows the operator to recap and remove the syringe needle in complete safety, eliminating the risk of accidental needle sticks to both healthcare workers and those responsible for the disposal of sharps.

Sterilizable: autoclavable (121°C for 15 min. or 135°C for 5 min.)

Ecological: promotes waste sorting as it enables just the needle to be disposed of in the sharps bin. Raw materials are biocompatible.

Safe: complete protection against accidental syringe needle sticks.

Economical: last 4 years, reducing costs by at least 50,000 € per year for a small hospital and over 200,000 € per year for a medium/large hospital.



THE PROBLEM: there are 960,000 accidental syringe stick injuries every year in Europe. The total cost estimate resulting from syringe needle stick injuries exceeds 1 billion Euros

LEGISLATION: European Directive 2010/32/EU requires Member States to adopt more effective provisions to protect workers from accidental needle stick injuries from syringes.

THE SOLUTION: margherita allows total safety to operator and to healthcare workers responsible for the disposable of sharps.

GIMA SECURITY SYSTEM TO FUSE NEEDLES UP TO Ø 1.6 mm

- 25820 SECURITY SYSTEM - needle destroyer

To avoid accidents from used injection needles, GIMA has developed and patented Security System.

This Needle Destroyer generates a temperature of 1,000°C, hot enough to destroy stainless steel and all known bacteria/viruses. It fuses in 1-2 seconds needles up to a diameter of 1.2 mm and with some more seconds needles up to 1.6 mm

Safe for nurses, doctors, cleaning staff and patients.

Most of accidents by punctures with needles take place in the following circumstances that are avoided using the Needle Destroyer: placing the needle in its protective sheath, discarding a needle from a used syringe, carrying hospital residues. Destroyed needle material is sterilized and stored in a drawer at the bottom of the unit.

Long life and easy maintenance

It is sturdy, over 4 kg weight, and manufactured in best quality material. Only necessary maintenance is to change fusing spare parts every 4,000 needles.

minimum order: 2 pcs.

- 25821 FUSING SPARE PARTS

TECHNICAL SPECIFICATIONS

Size: cm 22x14x h 9 Weight: 4 kg Power: 90 Watt Fuses: 2x2,5 A T
Operating voltage: 220 V - 50/60 Hz Norms: CEI 62-5 - IEC 601-1
Fusion temperature: 1,000°C Made in Italy: GIMA S.p.A.

SECURITY SYSTEM ELIMINATES ACCIDENTAL CONTAGION OF INFECTIOUS DISEASES CAUSED BY NEEDLE-PUNCTURES



25820

GIMA SHARPS CONTAINERS



- pocket size
- ergonomic shape
- easy to use with just one hand
- double opening system: needles and insulin pen removal, entire syringe disposal
- maximum filling level indicator
- no emission of any harmful gas during the incineration process
- temporary and permanent closure
- possible side fastening



- simple and practical snap-type closure
- easy manoeuvre for temporary opening with just one hand
- wide opening for the disposal of voluminous material
- mechanism for the unhooking of insulin needles
- maximum filling level indicator
- no emission of any harmful gas during the incineration process



- ergonomic handle for the more spacious models
- anti-defluxion wings that prevent the outflow of the waste
- mechanism for unhooking insulin needles
- maximum filling level indicator
- no emission of any harmful gas during the incineration process

code	POCKET SHARPS CONTAINER	Minimum order	code	PBS SHARPS CONTAINERS	Minimum order
25780	Pocket 0.4 l - 12.3x6.2x16.5h cm	box of 70	25790	PBS 0.6 l - Ø 10x14.5h cm	box of 100
CS LINE SHARPS CONTAINERS			25791	PBS 1.5 l - Ø 14x16.7h cm	box of 100
25783	CS 3 l - 16.7x16.7x22.2h cm	box of 50	25792	PBS 2 l - Ø 14x21h cm	box of 75
25784	CS 4 l - 16.7x16.7x28.5h cm	box of 40	25793	PBS 5 l - Ø 23x19.5h cm	box of 55
CERTIFICATIONS			25794	PBS 7 l - Ø 24.8x19.5h cm	box of 40
			25795	PBS 12 l - Ø 24.8x31.34h cm	box of 25



WASTE CONTAINERS - 30-50-60 l

- WASTE CONTAINERS - 3 sizes**
- extremely solid and shock resistant at high and low temperature
 - hermetic seal by peripheral adhesive on the lid (single or double)
 - lateral handles
 - excellent stacking possibilities

code	WASTE CONTAINERS			
	Tide	Lid	Max load kg	Size
25774	Container 30 l	single	15	40x30x39 cm h
25775	Container 30 l	double	15	40x30x39 cm h
25776	Container 50 l	single	20	40x30x56 cm h
25777	Container 50 l	double	20	40x30x56 cm h
25778	Container 60 l	single	25	40x30x65 cm h
25779	Container 60 l	double	25	40x30x65 cm h



BD SHARPS CONTAINERS

- SHARPS CONTAINERS BECTON-DICKINSON**
- Space saving containers, autoclavable at 121°C, with safety cover. Conform to BS7320:1990, NF x 30-500, ADR UN 3291
- 25822 BD SHARPS CONTAINER 1.5 l - 16.5x16xh 20.5 cm
 - 25823 BD SHARPS CONTAINER 3 l - 18.2x18.1xh 26 cm
 - 25827 WALL SUPPORT for 25823
 - 25828 BD SHARPS CONTAINER 7 l - 30.4x22.2xh 25.5 cm
 - 25829 BD SHARPS CONTAINER 22.7 l - 32x22.7xh 44.5 cm



TOURNIQUETS IN LATEX, RUBBER-COTTON AND LATEX-FREE

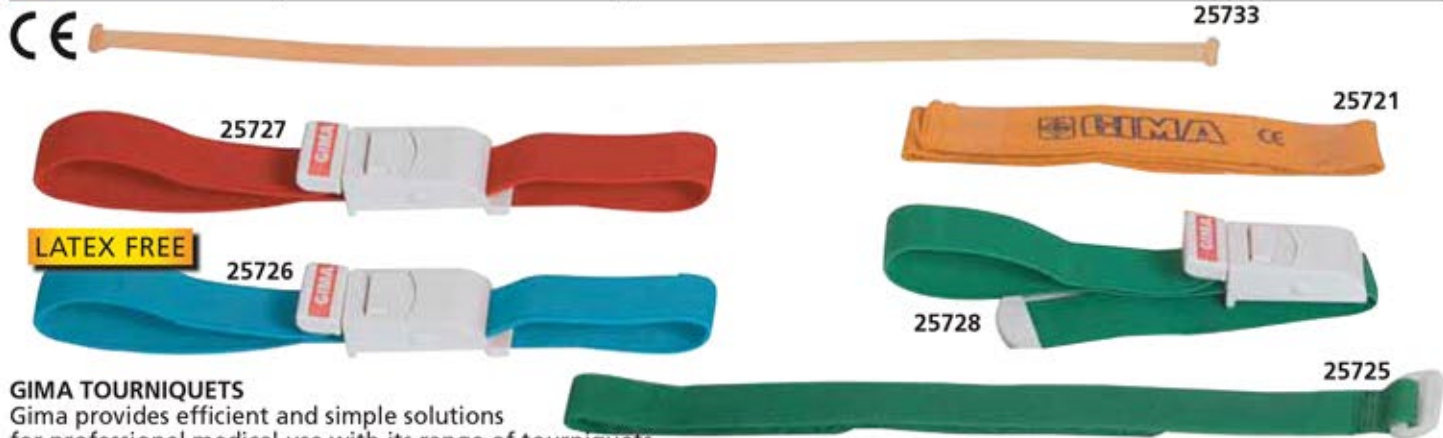

GIMA TOURNIQUETS

Gima provides efficient and simple solutions for professional medical use with its range of tourniquets.

Latex: Ø 5 mm, for manual use

Velcro: for easy fastening

Velcro "D" buckle: self applicable made of a nylon band threads through plastic "D" buckle

Lock system: self applicable with a quick release system.

Multilanguage box (excluding 25733): GB, FR, IT, DE, ES, PT, GR, Arab.

Velcro system



code	TOURNIQUETS	Material	Colour	Length cm	Fastening systems	Origin
25733	TUBOLARE Tourniquet - box of 200	Latex	Yellow	33	Manual	Europe
25721	GIMA Tourniquet	Rubber-cotton	Yellow	40	Velcro	Asia
25725	STRIP-VELCRO Tourniquet	Velcro	Green	45	Velcro+ring: use with one hand	Asia
25727	FAST Tourniquet	Rubber-cotton	Red	40	Single lock system: quick release	Asia
25728	FAST Tourniquet	Rubber-cotton	Green	40	Single lock system: quick release	Asia
25726	FAST Tourniquet	Rubber-cotton-latex free	Blue	40	Single lock system: quick release	Asia

JETPULL 2 WITH GRADUAL ADJUSTMENT - MADE IN GERMANY



JETPULL 2 WITH GRADUAL ADJUSTMENT

Easy to use, allows single-hand operation.

The patented 2 button system allows an easy opening of the fastening with 2 choices: smooth or fast, even when under tension.

Fastening device is made using recycled plastics (PVC free).

Ribbon is in special material to avoid any skin bruises. Blood proof.

Washable at 60/90° C and autoclavable. Made in Germany.

Jetpull system

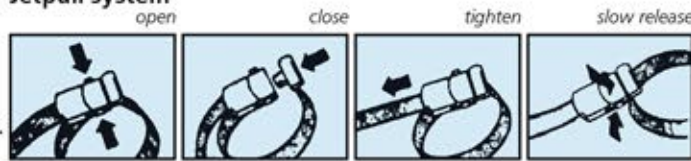

code	TOURNIQUETS	Material	Colour	Length cm	Fastening systems	Origin
25722	JETPULL 2 Tourniquet	Rubber-cotton	Blue	56	Double lock system: quick and slow release	Germany
25723	JETPULL 2 Tourniquet	Rubber-cotton-latex free	Green	56	Double lock system: quick and slow release	Germany
25724	JETPULL BABY Tourniquet	Rubber-cotton	Child design	56	Double lock system: quick and slow release	Germany

SHARPS CONTAINERS UP TO 72 CM

LONG SHARPS CONTAINERS

Disposable containers for the elimination of long objects up to 72 cm, such as biopsy forceps and sharps.

Large opening, for elimination of bulky objects, temporary and definitive closure, ergonomic handle.



code	LONG SHARPS CONTAINERS
25797	Magnum 6.3 l - 17.2x12x62.1 cm
25798	Magnum XL 8.3 l - 17.2x12x85.3 cm
25799	Fixing system* - horizontal or vertical

* Suitable for wall or trolley

TAPE TOURNIQUET

• 25740 TAPE TOURNIQUET - latex free - disposable
 Latex free disposable tape tourniquet made in TPE. Each box contains 25 pre-cut tourniquets 42x2.5 cm (18"x1") with 0.5 mm thickness.



HIGH QUALITY LEATHER BAGS - MADE IN ITALY



PRIME LEATHER

27126

External dimensions:
42x12xh 30 cm

• 27126 PRIMATO prime leather - colour: leather
2 inside partitions, one with articles-holder, and large zip-fastener pocket. External large zip-fastener pocket, burnished locks.



27110

External dimensions:
35x12xh 22 cm

• 27110 TEXAS leather - colour: chestnut
Rigid bottom, inside pocket with button fastening, burnished lock.



27115



27116

External dimensions:
42x20xh 23 cm



27118

• 27115 SUPERTEXAS leather - colour: black
• 27116 SUPERTEXAS leather - colour: chestnut
• 27118 SUPERTEXAS leather - colour: bordeaux

With outer pocket and inside zip fastener pocket, 2 burnished locks, inside transversal partition 8 cm from side, large central area.

QUALITY LEATHER BAGS



27123

27122

External dimensions:
38x20xh 20 cm

• 27122 FLORIDA leather - colour: black
• 27123 FLORIDA leather - colour: brown
Rigid bottom, inside zip fastener central pocket, lateral inside pocket, burnished lock.



PRIME LEATHER

27120

External dimensions:
34x17xh 21 cm

• 27120 VALIGETTA prime leather - colour: leather
Rigid bottom, inside zip-fastener pocket and inside folding pocket.



KANSAS BAGS - 5 COLOURS

• 27095 KANSAS skay - black
• 27096 KANSAS skay - chestnut
• 27097 KANSAS skay - electric blue
• 27098 KANSAS skay - ochre
• 27099 KANSAS skay - brown
Rigid bottom, outer velcro pocket, inside partition, inside zip pocket, lock with key.
Made in Asia - Italian design.

External dimensions:
42x20xh 24 cm



27095

27097

27096

27098

27099

AVAILABLE IN ANY COLOUR
minimum order 200 pcs

SIMULATED LEATHER BAGS - MADE IN ITALY



27100 TEXAS skay - colour: black
 27101 TEXAS skay - colour: cognac
 Rigid bottom, inside pocket with button fastening, burnished lock.



27104 INFERMIERA skay - colour: cognac
 Rigid bottom, inside zip fastener pocket and inside folding pocket, burnished lock.



27108 LARGE POLUS skay - colour: cognac
 Rigid bottom, inside zip fastener folding pocket, elasticated retainers for instruments on both inside sides.



27105 SUPERTEXAS skay - colour: cognac
 With outer pocket and inside zip fastener pocket, 2 burnished locks, inside transversal partition 8 cm from side, large central area.

SHIVER COOLBOX 30 I



27214 SHIVER COOLBOX 30 I
 External size: 29.7x39.5xh 48.5 cm
 Inner size: 33x24xh 42 cm
 Equipped with ice packs 2x400 ml
 27206 THERMAL ICE PACK - spare - box of 2

TECHNICAL SPECIFICATIONS
 Material: polypropylene
 Insulation: high density expanded polyurethane foam
 Lid featuring built-in 2x400 icepacks holder with swing locking system
 Vertical space for up to six 2-litres bottles
 Gasket between body and lid for improved sealing

PROFESSIONAL VACCINE CARRIER

27211 PROFESSIONAL VACCINE CARRIER
 Compact, extra strong with special insulation by high density PU foam suitable for transportation of vaccine. Comes complete with 8 empty ice-packs 400 ml suitable for a cold life of 40 hours at 8°C with external temperature of 43°C without opening.
 Vaccine storage capacity: 2.6 l.
 Body and lid with gaskets for better insulation.
 External size: 28.5x25.5xh 32 cm.
 Internal size: 22x18xh 24 cm.
 Made in Italy.



IP67 CERTIFIED, TOUGH, DURABLE CASES - MADE IN ITALY



- 1 - Watertight seal around lid
- 2 - Automatic pressure release valve
- 3 - Easy to open double throw latches
- 4 - Load tested soft grip handle
- 5 - Holes for double padlocking
- 6 - Holes for shoulder strap
- 7 - Stackable interlocking system
- 8 - Thick body material
- 9 - Extra fixing points
- 10 - Fully length hinges
- 11 - Nylon pins, corrosion free
- 12 - Pick N Pluck foams in the bottom and convoluted foam in the lid
- 13 - Screen printing space on the lid

GIMA CASES
 GIMA cases are IP67 certified tough, reliable and extremely durable in any condition. They offer superior protection from the elements, water, dust and impacts, making them suitable for a wide range of applications. Can be supplied with or without internal foam.



code	CASES WITHOUT INTERNAL FOAM		
		Internal size	External size
27220	Medium - orange	426x290x159 h	464x366x176 h
27221	Medium - black	426x290x159 h	464x366x176 h
27222	Large - orange	500x350x194 h	555x428x211 h
CASES WITH INTERNAL FOAM			
27226	Medium - orange	426x290x159 h	464x366x176 h
27227	Medium - black	426x290x159 h	464x366x176 h
27228	Large - orange	500x350x194 h	555x428x211 h

PROFESSIONAL COOL BAG

Waterproof zips

Removable shoulder strap

High quality insulation

Tested inner temperature 30°C for 11h at room temp 34°C

Padded PC case



MEDI-TRAVEL COOL BAG



27253



Detachable insulated pouch



Base storing 3 insulin

27210 MEDI EXECUTIVE PROFESSIONAL INSULATED COOL BAG

Professional bag studied for lab samples and medicine transportation. Two compartments separated by inner removable panel: one for documents and one for medicines. Comes with 2 cube cases and 3 soft ice cooling cushions included. Size 38x25x31 cm. Capacity 26 l.

27253 MEDI-TRAVEL COOL BAG - 23x11x21 cm

Compact cool bag for medicines. High quality insulating material and finish. Waterproof zips. Internal pocket with zip. Removable insulated base independently usable for storing 3 insuline or thermolabile medicines. Supplied with 2 reusable gel cushions.

27217 SOFT ICE TEMPERATURE PACK - display of 12

MEDIPOCKET AND MEDINSULINE INSULATED COOL BAGS

MEDI POCKET 12x65x20 cm

MEDINSULINE 10x5x18 cm



27252

27207

27208



Soft ice gel cushion included



27201



27202



27203

INSULATED COOL BAGS

Compact insulated bags for insulin and thermolabile medicines transport. High quality insulating material and finish. Waterproof zips. Internal pocket with zip. Supplied with 1 reusable gel cushion.



Opening of 27207/18, 27252



Interior of 27201/23

Blue/beige	Red/white	DarkGrey/beige	INSULATED BAGS
27252	27207	27208	Medi Pocket
27201	27202	27203	Medinsuline
27217			Soft ice temperature pack - display of 12

THERMAL BAG

Size: 34x25x24 cm

27209



27209 THERMAL BAG - Colour yellow - nylon Thermal bag with pockets. Its temperature pack maintains cold or hot temperature for prolonged periods. Beautifully crafted, durable, insulated bag with detachable shoulder straps. 3 temperature packs included. Internal size: 30x23x21 cm. Made in Italy.



27206

DIABETIC BAG

Size: 17x11.5x5.5 cm

27254

Temperature pack 100 cc

27255

Size: 24x18x6 cm



27255 DIABETIC BAG - empty - blue

27254 MINI DIABETIC BAG - empty - blue

Thermal pharmaceutical bags designed specifically for carrying medicines that must be kept at cool temperatures, ideal for diabetics. Temperature pack included to provide a temperature of about 10°C for up to 10 hours. Exterior material is a water repellent vinyl nylon with a foam backing. Made in Italy.

UTILITY BAGS



- 27125 UTILITY DOCTOR BAG - blue - empty
 - 27127 UTILITY DOCTOR BAG - beige - empty
- Practical doctor bag for easy transport of instruments and medications, provided with 8 internal movable divisions, 3 external pockets, 8 elasticated retaining, 1 internal pocket with zip, 1 removable mini bag (17x3xh 24 cm). Size: 36x22xh 25 cm.



Made in water resistant 600D polyester

27127

PROFESSIONAL BAG



Made in 70D nylon (external) 600D polyester (internal)

- 27128 PROFESSIONAL BAG - empty
- Professional versatile bag, designed for general practitioners and any professional. It includes: 3 detachable transparent pouches with velcro, 1 ampoule holder with 23 elastic bands with velcro, 1 large pouch with 4 dividers with velcro, clip paper board, document holder, various pockets. Shoulder strap, handle, hidden straps to carry on back. External size: 42x35x15 cm. Weight: 3.3 kg. Maximum recommended contents weight: 5 kg.

VIAL BAGS



For 24 small phials

For 9 large and 13 small phials

27133

27129

Central partition with double transparent pocket

- 27129 MAXI VIAL BAG - red - 600D polyester - 29x24xh 7 cm
 - 27133 MEDICATION BAG - blue - 600D polyester - 34x24xh 7 cm
- The best way to protect, identify and organize up to 46 phials of any size. Made of two parts, with elastic strips for holding 9 big and 37 small ampoules.
- Compact bag made in water-proof anti-scratch 600D polyester: 2 internal zip pockets and 9 elasticated retainers.

DIATERMO BAG



Size: 30x40xh 14 cm

27139

- 27139 DIATERMO BAG - black - 600D polyester
- Designed to carry small electrosurgical units, audiometers, spirometers, ECG with their accessories. One division to separate device from accessories and one zip pocket.

THERMIC CUBE CASES

- 27204 THERMIC CASE - small - 16.5x8.5xh 13.5 cm
 - 27205 THERMIC CASE - medium - 16.5x8.5xh 18.5 cm
- Light and compact insulated bag, ideal for thermolabile medicines. Can be used alone or as accessory to cool boxes and bags.



27204

27205

INSTRUMENT AND VIAL BAGS



Padded protection and velcro fastening

25742

25745

With zip closure



Padded in velvety cloth with protection and velcro

26650

26649

PRO SPIKE FOR USED NEEDLES

- 27149 PRO SPIKE
- Pro spike is a small disposable plastic container for the separate collection of spiky and cutting wastes (needles, scalpels) on the operation field. It has a clever lid with a safe closing system and a clip so you can attach it to belts and backpacks. Made in plastic material. It can be disposed of with the contents.



Size: 90x54x185 mm
Weight: 88 g

27149

code	VIAL INSTRUMENT BAGS*	Size	Colour	For
25742	Vials bag	19.5x15xh3 cm	Blue	12 vials
25745	Mini Vials bag	18x14xh2 cm	Black	6 vials
26650	Instrument bag	19.5x15xh3 cm	Black	12 instrum.
26649	Mini Instrument bag	18x14xh2 cm	Black	8 instrum.

*Made in 600D polyester (external)

SMART EMERGENCY BAGS

POLYESTER



27153 27152 27150

Shoulder straps included with medium and large bag.

4 pockets (5 for 27153) 1 or 2 on front, 2 on sides and 1 on back



27153

POLYESTER WITH OUTER PVC COATING



27157 27158 27155

Large pocket on top and shoulder straps included with medium bag



Safe metal buckles Large 10 mm zips Rubber bottom with feet Shoulder straps



Removable lining for easy cleaning

Large pocket on top

27157

Padded bottom and frontal pocket

SMART BAGS: polyester or polyester PVC coated - empty
Professional emergency bags extremely capacious with internal adjustable compartments which permit personalized organization of the space. Provided with external pockets, internal divisions, and one (2 for code 27153) removable pouch with transparent window. All bags are made in strong, water resistant 600D polyester. Available also with outer PVC coating (27155-8). Provided with double yellow reflective strips. Internal lining is removable for easy cleaning. Waterproof rubber bottom to prevent water infiltration. May be carried on shoulder or hand.

Polyester	Polyester PVC coated	Model	Colour	Size	Internal modular spaces	External pockets
27150	27155	Small	red	45x28xh 28 cm	3	4
27151	-	Medium	red	55x35xh 32 cm	6	4
-	27157	Medium	red	55x35xh 38 cm	6	5
27152	-	Medium	blue	55x35xh 32 cm	6	4
-	27158	Medium	black	55x35xh 38 cm	6	5
27153	-	Large	red	65x35xh 35 cm	6	5

EMERGENCY BAGS - POLYESTER OR POLYESTER PVC COATED

POLYESTER

POLYESTER WITH OUTER PVC COATING



27165 27167 27166



2 lateral pockets 22x18 cm and 11x18 cm

Lateral pocket 32x18 cm

27167

Front pocket 35x20 cm

- 27165 EMERGENCY BAG - polyester - red - 35x45xh 21 cm
 - 27166 EMERGENCY BAG - polyester PVC coated - red - 35x45xh 21 cm
 - 27167 EMERGENCY BAG - polyester PVC coated - blue - 35x45xh 21 cm
- Capacious bag, despite the compact size. Large central compartment, 1 front and 3 lateral pockets. May be carried on shoulder (braces) or hand (2 handles).

Made in strong, water resistant material (600D polyester). Available also with outer PVC coating (27166-7). Provided with yellow reflective strips and rubber bottom.

CUBO EMERGENCY BAG



27163

• 27163 CUBO EMERGENCY BAG - polyester PVC coated - red
Portable emergency bag with internal and external zip pocket and 2 removable pouches with transparent window.
Made in strong, water resistant 600D polyester with outer PVC coating. Provided with double reflective yellow strip.
Size: 28x34x13 cm.

LIFE-2 EMERGENCY BAG



27161

• 27161 LIFE-2 EMERGENCY BAG with 5 coloured pouches
2 section first-aid bag with double opening zip: bottom side with shockproof inner basin, upper side with 5 removable coloured pouches (model E1) with transparent window.
Made of strong, water resistant 600D polyester material and provided with reflective yellow strips.
Shoulder or hand portable. Size: 47,5x33xh 30 cm.

MEDICATION BAG



27132

• 27132 MEDICATION FIRST AID BAG - 31x22x11 cm
First aid bag provided with 2 internal transparent pockets, one external pocket, internal division with 2 zips on both sides, handle and carrying belt.

HOLSTERS



27145

27146

27147

GIMA HOLSTERS - EMPTY	Size	Colour	
		Red	Blue
Large Holster - with pocket	21x12xh 6.5 cm	27147	27148
Flat Holster	19x14xh 1 cm	27145	27146

POUCHES WITH VELCRO

Padded back and front

E5 27197



E3 27188



E2 27184



E4 27194



Padded back

POUCHES WITH VELCRO

All pouches are provided with a large strip of female velcro on back.

Made in 600D polyester.



E1 27180

E6 27200

Model	Size - cm	RED	BLUE	YELLOW	GREEN	Standard with
E1	20x11x8	27180	27181	27182	27183	27161
E2	28x12x10	27184	27185	27186	27187	27170/1/4/5, 27150-8
E3	28x15x11	27188	27189	27190	27191	27171
E4	33x15x11	27192	-	27194	-	27151/2/7/8, 27175
E5	29x19x11	27196	27197	27198	27199	27174
E6	38x10x5	27200	grey colour			

NYLON BAGS IN 5 COLOURS

NYLON BAGS - 22x15.5 cm

Blue	Green	Red	Black	Grey
32791	32793	32794	32795	32796
32792 Same as above with inner foam				



32792

Provided with zip closure and external pocket with velcro closure

LOGIC-1 RUCKSACK

27170



• 27170 LOGIC-1 RUCKSACK - polyester - medium - 40x20xh 47 cm
Supplied with 5 coloured pouches with transparent window and velcro strips, 2 frontal pockets and 2 lateral pockets. Internal velcro strips and elastics, to retain instruments. Provided with yellow reflective strips.



27170

LOGIC-2

RUCKSACKS

POLYESTER

27171



• 27171 LOGIC-2 RUCKSACK - polyester - large - 40x25xh 47 cm
• 27172 LOGIC-2 RUCKSACK - polyester PVC coated - large - 40x25xh 47 cm
Rucksack made in strong water resistant 600D polyester. Available also with PVC outer coating (27172 only). Supplied with 6 coloured pouches with transparent window and velcro strips, 2 frontal pockets and 2 lateral pockets. Internal velcro strips and elastics, to retain instruments. Central division with zip and elastics. Provided with yellow reflective strips and shoulder straps.

POLYESTER WITH OUTER PVC COATING

27172



27171

27172

AMBULANCE RUCKSACK

SILOS-2 RUCKSACKS

27174



Large 10 mm zips

27174

• 27174 AMBULANCE RUCKSACK - polyester
Modular extra large rucksack provided with 8 internal pouches, 4 coloured with handle (model E5) and 4 coloured with transparent window (model E2). Velcro internal strips for pouches fixing. Provided with double yellow reflective strip.
Size: 40x30xh 57 cm



Rubber bottom



27174



27168

Velcro removable plate

POLYESTER

• 27168 SILOS-2 RUCKSACK - polyester - blue - 38x24xh 50 cm
• 27169 SILOS-2 RUCKSACK - polyester PVC coated - red - 38x24xh 50 cm
Professional rucksacks made in strong water resistant 600D polyester and with PVC outer coating (27169 only)
- removable compartment with 4 transparent pockets and many elastic strips
- central storage space with 3 pockets, velcro strips and elastic strips
- two external pockets with elastic strips and velcro strips: one 35x16 cm, one 35x32 cm with 4 internal transparent pockets
- rubber bottom with 4 feet
- two removable external plates for printing name
- comfortable back shoulder straps and plastic handle on both sides.

POLYESTER WITH OUTER PVC COATING

27169



27169

GIMA PODOSCOPE WITH POLARIZED LIGHT

27363

Methacrylate



• 27363 GIMA LED PODOSCOPE

The GIMA Podoscope with polarized light allows operators to observe the foot plant highlighting the points with the heaviest pressure. The patient stands on the methacrylate platform, an excellent light conductor, provided with an inner light source to detect variations of colour intensity on the foot plant, corresponding to higher or lower plant charge.

Highly resistant, easy maintenance

The GIMA Podoscope with polarized light has been designed for a long lasting duration. High-quality material and components, serial assembly and control checks constantly performed during production and at final test, provide superior accuracy. Its structure is resilient and can bear charges up to 135 kgs - 297 lbs. Its green-light LED has a life of 25,000 hours (duration indicated by the manufacturer).

Easy to use, light and practical

The GIMA podoscope becomes operative at once simply switching it on. Just after the patient has stepped on it, in real time you can proceed with the study. The device is meant to be practical and easy to use. Since methacrylate is light and resistant at the same time, the device can be comfortably moved from a place to another, also thanks to its limited dimensions. The step is low: 22 cm from ground level, so that even elderly patients can easily step on it.

TECHNICAL SPECIFICATIONS

Capacity: 135 kg - 297 lbs
 Dimensions: 43.5x42.5x22 cm - 17.12x16.75x8.67 inches
 Weight: 8 kg - 17.63 lbs
 Operating voltage: 220 V-50/60 Hz - Schuko plug (British plug available on request)
 Green light LED stripe with 25,000 hours of life

POSTURAL ANALYSER

Adjustable upper mirror.

27387



• 27387 NEW POSTURAL ANALYSER

Devices for analysing posture in the frontal, rear and lateral planes. The patient stands with feet in the positions indicated on the platform. It includes a platform, elastic grid, two aluminum side bars, measuring indicators with plumb line for postural reference (Barré's vertical evaluation) and adjustable mirror on top. The image reflected in this upper mirror allows observation of any rotation of the shoulders. Manual: GB, IT. On request ES.

Adjustable upper mirror.



27352

Size: 80x72x225 cm
 Capacity: 135 kg

PLUMBING WEIGHT

• 27355 PLUMBING WEIGHT

Made of stainless steel (magnet) with wire length 150 cm. Supplied in wooden case. Size: 6.2x2.3 cm. Weight: 140 g.



27355

LED PODOSCOPE

Working surface 32x36 cm



27353

Size: 46x55x33 cm
 Weight: 15.5 kg
 Power: 100-240 V, 50/60 Hz

• 27353 LED PODOSCOPE

Device for the plantar analysis of the feet. It has a lacquered wooden structure and a crystal top with an inclined mirror below it for a real view of the sole of the feet, which highlights the points of greatest and least load. Double lateral illumination with high level effect lamps. Max Load 200 kg. Strong reliable and professional product, made in Italy.

SCOLIOMETER

• 27351 SCOLIOMETER

Plastic instrument for the evaluation of the scoliosis (deviation of the spinal column on the lateral, left and right planes). The instrument detects the anomaly and its gravity. It also allows to compare reports during the time and define the evolution of the measured pathological process, thus reducing the need of frequent radiographical tests. The small sphere oscillating within an air space indicates the spine inclination degree, compared to the horizontal plane.



27351

SMEDLEY HAND DYNAMOMETER



28791

• 28791 SMEDLEY HAND DYNAMOMETER - aluminium

Spring type hand dynamometer used to measure grip strength. Adjustable handle comfortably accommodates any hand size. Dial indicator remains at maximum until reset and is calibrated both in kg (0-100) and pounds (0-220). Manual in: GB, FR, IT, ES.

HAND GRIP METER



28790

• 28790 HAND GRIP METER - plastic Indicator remains at maximum until reset and is calibrated 0-75 kg. Size 20x15 cm.

Sold in a blister. Manual in: GB, FR, IT, ES.

STAINLESS STEEL GONIOMETERS



• **24900 FINGER GONIOMETER 6" - 15 cm**
Finger goniometer measures range of motion of finger joints. Linear scale in inches and centimeters on arms. 180° scales marked in 5° increments.



• **24901 180° DIGIT GONIOMETER 6" - 15 cm**
Allows taking readings using only one hand. Measures 110° flexion through 40° hyperextension in 5° increments.



• **24903 360° GONIOMETER 14" - 35 cm**
This goniometer has two opposing 180° scale and one 360° scale all marked in 1° increments. Sturdy adjustable knob, controlling tension of arms.



• **24902 180° ROBINSON GONIOMETER 7" - 17.5 cm**
Pocket size 180° Robinson goniometer for doctor and therapist. Linear scale marks 5° increments.



• **24904 180° EXTRA LONG ARMS GONIOMETER 14" - 35 cm**
Extra long arms, useful for measuring all joints. Arm has a linear scale marked in 1° increments.

GONIOMETERS

Used by orthopaedic surgeons to measure the range of movement of joints: elbows, knees and fingers.

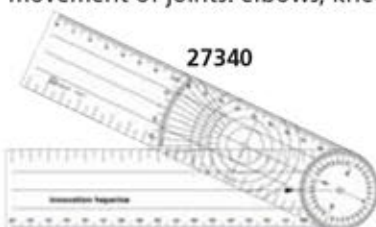

• **27340 GONIOMETER - 205x45 mm**
With circular scale used to check the size of hip joints and the angle of the femoral neck on X-rays. Personalisation with your logo for minimum 2,500 pcs.



• **27339 GONIOMETER WITH PAIN SCALE RULER - 203x45x7 mm**



• **27338 GONIOMETER WITH ARMS (tolerance 1°)**
Measures analytical motility of various body segments in degrees (from 0 to 360 clockwise or anti-clockwise direction). Consists of two perspex arms (3 mm thick) that will remain open at any given position due to the friction at the joint between them. Two graded scales: one increasing scale and one decreasing scale.



BMI TAPE



• **27341 BMI - Tape Measure**
Pocket retractable tape measure 150 cm. BMI (Body Mass Index) calculator on front panel.
• **27342 BMI - Tape Measure**
Economical version of 27341.



27341

BODY TAPE

• **27343 BODY TAPE MEASURE**
Track your body measurements and progress. Measures any body part: arm, thigh, calf, chest, waist, hip...
Measures in inches and centimeters; total measurement length: 60 inches / 152 cm. Sturdy vinyl tape.

Push-button retraction and locking feature ensures easy measurement and superior accuracy.



BMI CALCULATOR



• **27336 BMI CALCULATOR - box of 10**
Used in hospital and surgeries gives an indication of general health through the ratio of weight to height. Made of 2 rotating discs: 108 mm diameter (base) and 76 mm (top). Can be personalized with your logo for a minimum of 1,000 pieces.

PROFESSIONAL BODY - HEAD TAPE

- **27347 PROFESSIONAL BODY TAPE**
- **27350 PROFESSIONAL BODY TAPE with pediatric gauge box**

Patented, professional body tape measure approved by the Italian Ministry of Health for adult and pediatric use. Tape is coloured on both sides to help to identify metabolic risk in abdominal measure for male and female. Length of tape: 8-150 cm. Thanks to its rounded shape, it can be used also as a head measure tape. Packed in single box.

Body tape with pediatric gauge box (27350)
Specific tape for pediatric use. Supplied in a box with a ruler to compare the measured head circumference with the standard percentiles of children's growth from 0 to 36 months. Suitable for both sexes.

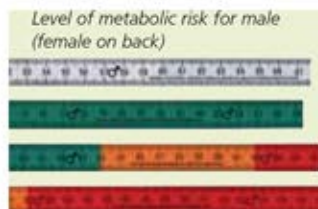

Multilanguage manual: GB, FR, IT, DE, ES, GR, PT, Arabic.



27350

MEASURING MAT FOR BABIES

seca

Although rugged, the surface is easy to care for and can be cleaned with all commercially available disinfectants

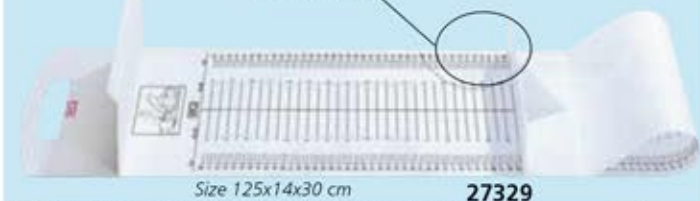

Size 125x14x30 cm

27329

- **27329 SECA 210 - BABY MEASURING MAT**
Mobile measuring mat for babies and toddlers. Kind to the skin, washable, foldable. The space saving solution for easy and precise measurement of baby length. Range 10-99 cm. Graduation: 5 mm.

CE 0123

SECA INFANTOMETER

CE 0123

The unique V-shape automatically places the baby in the right measuring position

seca



The head and foot positioners lock into place to capture results. Indication can be read after measuring

- **27316 SECA 416 - INFANTOMETER**
Infantometer for measuring babies and toddlers in hospital. The sturdy construction and stability of the infantometer makes it quick and easy to measure babies and toddlers up to two years old. The board is generously designed and the raised and softly rounded sides guide the baby easily and safely into the right position. Permanently mounted with rollers on two guide rails, the footpiece slides smoothly along the scale. Because the footpiece is lockable, the baby can be removed and the result noted later. All parts are tough and durable. Measuring range: 33-100 cm. Graduation: 1 mm. Size: 110x16.9x40.2 cm. Weight: 3.8 kg.

GIMA PEDIATRIC MEASURING INSTRUMENTS

CE 0476

27326



- **27326 BABY MEASURE "CALIBRO"**
Made of oxidized aluminium, metric graduation 0-900 mm, division 5 mm. Certified by Italian "weights and measure institute". Weight: 300 g.
- **27327 CRANIOMETRO - HEAD MEASURE**
Made of special, soft, non stretchable plastic. Measures child head girth up to 60 cm.
- **27337 ORCHIDOMETER - wood**
Used by pediatricians for screening of children's testicles

CE 0476

27327



27337

A string of 12 numbered wooden beads of increasing size from about 1 to 25 mm used to determine size of testicles.

HEIGHT MEASURE

- **27335 TAPE HEIGHT MEASURE**
Clear scale 0-200 cm. Easy wall fixation. Supplied with screw for wall mounting.

CE 0476



ELECTRONIC HEIGHT ROD

SOEHNLE PROFESSIONAL
LCD digit height: 9 mm

27333



Size: 345x92x28 mm Power supply: 2x1.5 V AA batteries Weight: 300 g

- **27333 SOEHNLE ELECTRONIC HEIGHT ROD**
Measuring range: 50-240 cm (20-94.5 inches), division: 1 cm. Manual in: DE, GB, FR, ES, IT, GR, CZ.

Switchable to inches

Size: 630x290x70 mm

Power supply: 2x1.5V AAA batteries

- **27264 SOEHNLE BABY HEIGHT ROD**
Digital and mechanical rod 35 to 80 cm, division 1 cm. LCD display, digit height 16 mm. Manual in 23 languages.

27264

BONE MEASURE

- **27325 BONE MEASURE**
Slide-knot caliper in anticorodal to measure knee, shoulder, wrist, elbow... Measuring capacity: 150 mm. Burner length: 100 mm. Tested by Italian "weights and measures institute".

CE 0476

27325



PROFESSIONAL SKINFOLD CALIPERS: MECHANICAL AND DIGITAL



- 27320 PLICOMETRO - Professional skinfold caliper - mechanical
- 27346 PLICOMETRO - Professional skinfold caliper - digital with PC cable for data transfer USB

This high precision instrument measures the thickness of a fold of skin with its underlying layer of fat giving physicians the situation of the subcutaneous tissues of the patient.

Possibility of re-calibration

Produced to meet International Standards, the Gima "Skinfold caliper" has springs which exert a pressure of 10 g/mm² on the skinfold and an accurate scale which measures thickness in mm. With possibility of re-calibration of the pressure it solves the major problem of traditional skinfold caliper that is reduction of the tension of the spring in the time.

Easy to use and read

With double reading scale (27320) or digital display (27346), it is supplied with picture showing advised positions for measurements. Tables will help obtain correct % of body fat from measured data and make a correct evaluation of the patient.

Stylish and user-friendly

A special nylon finish makes the device feel skin, avoiding trouble of contact with metal. Made in metal and sold in an attractive wooden box (19x36xh 6 cm). Made in Italy, provided of medical device CE certification. User manual in GB, FR, IT (both models), ES, DE, (27320 only).

Data management on PC (only 27346)

For immediate data transfer on most programmes (Excel, Word, Open Office, ...). Requirements: Windows 2000, XP (Service Pack 2), 7, Vista. USB 2.0 minimum.



FAT-2 SKINFOLD CALIPER



- 27349 FAT-2 SKINFOLD CALIPER
- Aluminium, light weight skinfold caliper to measure body fat. Large, easy to read 67 mm scale. Supplied with a protective carrying case and measuring procedure. Multilanguage manual in: GB, FR, IT, ES.



FAT-1 SKINFOLD CALIPER

- 27344 FAT-1 SKINFOLD CALIPER

Economic but precise and accurate skinfold caliper for professional use, made in Italy. Measures the thickness of skin folds over the body, based on the characteristics developed by Tanner and Whitehouse:

- pressure on the fold: approx 10 g/mm²
- contact surface on the fold: approx 6x11 mm

It allows a correct evaluation of the nutritional status and the sectoral distribution of adipose tissue. Raise a fold of skin with your fingers and measure its thickness by the forceps (max opening 4 cm): on the top edge a scale in millimeters and an arrow measure the skin fold (triceps, subscapular muscles, etc...) with an accuracy of about ±2 mm. The coloured bands placed near the scale allow a simultaneous comparison of the measured value with referential percentages related to men and women. This information is included in the manual provided with the unit and facilitate the interpretation of the values. Advised in dietetics, cardiology, sports medicine, aesthetic medicine, gynaecology, pediatrics, ecc... Multilanguage manual: GB, FR, IT, DE, ES, GR.

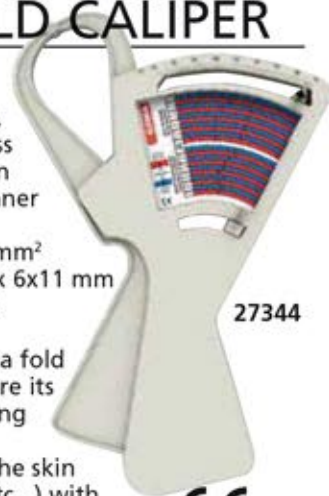

BODY FAT CALIPER

- 27318 BODY FAT CALIPER - plastic

Size 16.5x10x0.5 cm. Weight 22 g. Supplied into a polybag in a paper box.



OMRON BF511 BODY COMPOSITION MONITOR

- 27293 OMRON BF511 BODY COMPOSITION MONITOR

OMRON BF511 provides full body measurement with clinical accuracy, it is validated and classified as a medical device, even for kids.

It offers a comprehensive set of readings including body and visceral fat, skeletal muscle level, BMI and resting metabolism. Measurement with 8 sensors on both hands and feet for complete body measurement.

It uses the Bioelectric Impedance (BI) method, fat is shown as a percentage of body weight.

Multilanguage package and manual (GB, IT, FR, DE, NL, RU, Arab).

Battery operated: 4xAAA (included).



Extensive insight in your body composition

Resting metabolism is the minimum number of calories needed to sustain you every day



27293

BODY FAT ANALYZER WITH CARRYING CASE

• 27322 GIMA BODY FAT ANALYZER

Ideal for dieticians, gymnasias and sports centres, it is perfect also for homecare. It helps manage nutrition, fitness and weight control and can indicate if you are at the right weight and also whether you are nutritionally healthy.

Advanced technology in your hands.

GIMA Body Fat Analyzer measures the flow of electrical signals (total body electrical resistance or impedance) as they pass through FAT, LEAN (muscle, bones, vital organs) or WATER. When the amount of fat, lean or water changes, so does the Body Fat signal, giving you a highly reliable and accurate measure of the amount of each of these components that make up your total weight. Specifically, 4 electrodes are placed over metacarpus and metatarsus where a 50 kHz current is introduced. The detected signal level will be an index of total body water and fat free mass.

Only 2 minutes for an essential and easy test

Testing and results take less than two minutes and have the same accuracy as other more expensive devices.

A lot of meaningful data

FAT: actual weight of fat on the body

LEAN: actual weight of lean, mostly muscle and vital organs

WATER: water content in the body

% FAT: percentage of fat weight in total body weight

% LEAN: percentage of lean weight in total body weight

BMR: basal metabolic rate

Target Weight: weight goal under optimal condition

Target % Fat: normal percent for sex and age

Portable, for performing test everywhere

Small size and light weight for portability.

Body Fat Analyzer helps get and stay fit.

It helps maximize personal level of fitness if you want to lose weight, build muscle, tone and trim, or simply be sure you are maintaining your current level of fitness:

- enables you to check effectiveness of weight loss programme, telling exactly where your weight loss is coming from (fat-lean-water)

- it helps monitoring improvements in muscle mass as a result



of exercise and/or diet
- establishes a baseline for your body composition, so that nutritional and fitness improvements can be regularly monitored. **Frequent calibration** (code 27324 calibration kit) is necessary for accurate results in the time.

Supplied with a carrying case, kit of 2 sensor cables, sensor pads (box of 20), 2x9 V batteries, transformer and manual (GB, IT, FR, ES).

- 27321 SPARE SENSOR CABLES (kit of two)
- 27323 SENSOR PADS (box of 20) - replacement
- 32205 9V ALKALINE BATTERY
- 27324 CALIBRATION KIT

TECHNICAL SPECIFICATIONS

Size: 66x176x208 mm Weight: 1,500 g (unit, battery and probe)
Test frequency: approx. 50 kHz Test current: less than 1mA
Power source: two 9 Volt DC batteries or 230 V (by transformer)

FITNESS SCALE

• 27286 SOEHNLE 7850 FITNESS SCALE

Fitness scale for measurement of muscle, fat and water components, BMI and caloric needs per day
- impedance measurement through hands, no need to take off the shoes

- simple self-explanatory menu guide on the glass surface

- no limit on measurement for over- and underweight people

- clothing weight value seasonally adjustable

- print-out of data/time, weight, data analysis and recommendations for nutrition and fitness activities

- CD-Rom with software included to edit the print-out and settings in DE, GB, FR, NL, ES, IT, HU, CZ, FI, SE, NO, DK, GR, PL, SI, RU, TR.

- kg/lbs/st selection function

Manual in: GB, FR, IT, DE, CZ.

• 33250 PAPER ROLL 57mm x 25m - box of 5

Extra large weighing platform



TECHNICAL SPECIFICATIONS

Capacity: 180 kg
Sensitivity: 100 g / 0.2 lb
Size - weight: 365x490xh 1,290 mm - 15.8 kg
Platform size: 365x480xh 45 mm
Power supply: 100-240 V, 50/60 Hz

BODY FAT SCALES

• 27088 LIBRA BODY FAT SCALE - white

• 27089 LIBRA BODY FAT SCALE - black

Multi function scales, for measuring body fat, water, muscle and bone mass. Supplied in a 4 colour box with multilanguage manual (GB, FR, IT, ES, PT, PL)

- equipped with 4 precision G sensors

- 8 user memories

- auto off in 30 seconds

- auto-on function

- 3 touch buttons for easier usage

TECHNICAL SPECIFICATIONS

Capacity: 150 kg / 330 lb - minimum 5 kg LCD Size: 62.5x62 mm
Sensitivity: 100 g / 0.2 lb Batteries (included)
Size: 310x310x18.8 mm Switchable kg/lb/st



Weight and analysis of results shown on scale

GIMA BIG DIAL SCALES



27239

TECHNICAL SPECIFICATIONS

Capacity: 160 kg Dial Ø: 180 mm
 Minimum measuring weight: 5 kg
 Sensitivity: 1,000 g Weight: 3 kg
 Dimension: 430x380x70 mm

• **27239 GIMA BIG DIAL SCALE**
 Mechanical scale with classic design: a large and clear dial, a robust housing made of steel. Supplied in multilingual gift box. Made in Europe.



• **27240 GIMA DIGITAL BIG DIAL SCALE**
 Digital scale with extra large, easy to read LCD display (65 mm). Strong and durable steel construction, comfortable platform. Lb/kg/st switchable by user. Supplied in multilingual gift box. Made in Europe.

8 language manual
 and box:
 GB, FR, IT, ES,
 DE, PT, GR, Arabic



27240

TECHNICAL SPECIFICATIONS

Capacity: 200 kg Sensitivity: 100 g
 Minimum measuring weight: 2 kg
 Power: lithium battery (included)
 Dimension: 430x380x70 mm



GIMA BATHROOM DIGITAL SCALES



LCD display
 74x38 mm



27262

• **27262 DIGITAL SCALE**
 Electronic bathroom scale with plastic platform. 4 sensor high precision system. Auto-on function, low battery and overload indicator. Lb/kg/st switchable. 9 languages colour box and manual: GB, FR, IT, ES, DE, PL, PT, GR, Arabic

TECHNICAL SPECIFICATIONS

Capacity: max 150 kg (330 lbs) - min. 3 kg (6.6 lb)
 Sensitivity: 100 g = (0.2 lb)
 Dimension: 299x297x32.4 mm
 Power: 1xCR2032 lithium battery - not included
 Warranty: 2 years



LCD display
 72x35 mm



27248

• **27248 DIGITAL GLASS SCALE - black**
 Electronic bathroom scale with 6 mm thick tempered glass platform. 4 high precision G sensors. Automatic on and off function. Lb/kg/st switchable by user.

TECHNICAL SPECIFICATIONS

Capacity: max 150 kg (330 lb) - min. 2 kg (4.4 lb)
 Sensitivity: 100 g (0.2 lb)
 Dimension: 300x300x19 mm
 Power: 1xCR2032 lithium battery - not included
 Warranty: 2 years

Ultra slim design:
 only 19 mm height

9 languages colour box
 and manual: GB, FR, IT,
 ES, DE, PL, PT, GR, Arabic

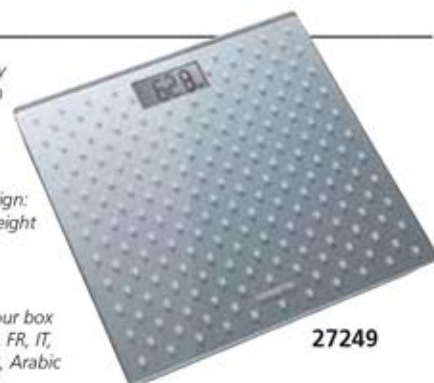

27249

• **27249 DIGITAL GLASS SCALE - grey**
 Electronic bathroom scale with 6 mm thick tempered glass platform. 4 high precision G sensors. Automatic on and off function. Lb/kg/st switchable by user.

TECHNICAL SPECIFICATIONS

Capacity: max 150 kg (330 lb) - min. 2 kg (4.4 lb)
 Sensitivity: 100 g (0.2 lb)
 Dimension: 300x300x19 mm
 Power: 1xCR2032 lithium battery - not included
 Warranty: 2 years

MECHANICAL SCALE



27230

• **27230 MECHANICAL SCALE**
 Analogue bathroom scale with stable construction and plastic cover. 18 languages box and manual instruction: GB, FR, IT, ES, PT, DE, GR, HR, HU, SI, RO, EE, LT, LV, CZ, PL, RU, Arabic.

TECHNICAL SPECIFICATIONS

Capacity: 125 kg (275 lb)
 Sensitivity: 1,000 g (2 lb) Warranty: 2 years

SOEHNLE AND OMRON DIGITAL SCALE



Large LCD
 display 38 mm



27231

• **27231 GALA XL DIGITAL SCALE**
 Digital bathroom scale with large and economic platform and bright LED digits. Automatic on and off function.

TECHNICAL SPECIFICATIONS

Capacity: 150 kg (330 lbs)
 Sensitivity: 100 g (0.2 lbs)
 Power: 2x1.5 V AAA batteries - included
 Packing size: 38x6x36.3 cm Weight: 2.4 kg
 Warranty: 5 years



UP TO
 180 kg



27091

• **27091 OMRON HN288 DIGITAL SCALE**
 Unique technology makes it easy to weigh persons but even, luggage and babies. Four integrated sensors for a reliable reading, up to 180 kg.

TECHNICAL SPECIFICATIONS

Capacity: 180 kg Sensitivity: 100 g
 Power: 2x1.5 V AAA batteries - included
 Packing size: 38x6x36.3 cm Weight: 2.4 kg

Weight difference
 function helps
 to accurately
 measure the
 weight of your
 baby without the
 need of manual
 calculation

SECA MECHANICAL SCALES



27241

27280

TECHNICAL SPECIFICATIONS

Capacity: 150 kg - 330 lbs
Sensitivity: 1 kg
Size: 317x117x477 mm Weight: 3.5 kg

TECHNICAL SPECIFICATIONS

Capacity: 150 kg - 330 lbs
Sensitivity: 500 g ± 2 g (27285) - 1,000 g (27280)
Size: 305x120x470 mm Weight: 3.5 kg

- **27241 SECA 750 SCALE**
Mechanical flat scale with sturdy, powder coated steel casing. Pretty and stable with its white powder coated lacquer.
A hard wearing synthetic white leather covers weighing platform. Made in Europe.
User manual in: GB, FR, IT, ES, DE, PT, PL.



- **27280 SECA 761 SCALE - medical use - Class III**
- **27285 SECA 762 SCALE**
Traditional model with large easy-to-read dial. Pointer professional scale in strong metal structure white painted.
Consistent accuracy on any surface.
Spacious platform design with no slip rubber mat, stable for safety.
Tare function.
User manual in: GB, FR, IT, ES, DE, PT, PL.

MEDICAL USE

GIMA BLUETOOTH SCALE



Supplied with manual in:
GB, FR, IT, ES, PT, PL, GR.

Analysis of results shown on APP



- **27090 LIBRA BODY SCALE with Bluetooth 4.0 - white**
Multi function scales, for measuring body fat, water, muscle and bone mass. Equipped with 4 precision G sensors, 8 user memories, auto off in 30 seconds, auto-on function.

TECHNICAL SPECIFICATIONS

Capacity: 150 kg / 330 lb - minimum 5 kg LCD Size: 62.5x62 mm
Sensitivity: 100 g / 0.2 lb Batteries (included)
Size: 310x310x18.8 mm Switchable kg/lb/st

AND BLUETOOTH SCALE



Durable glass plate

Selectable kg or lb



Continua HEALTH ALLIANCE



- **27256 AND UC-351PBT-Ci HEALTH SCALE - Bluetooth**
Advanced health scale designed for ease of use and accuracy. This device will facilitate your daily weight management. At the end of measurement, data is automatically sent from this scale to the receiver device through Bluetooth.

TECHNICAL SPECIFICATIONS

Capacity: 150 kg / 330 lb Sensitivity: 100 g < 100 kg > 200 g
Size: 350x350x39 mm Weight: 2.3 kg

iHEALTH WIRELESS AND BODY ANALYSIS SCALES

23506



Wi-Fi Sync, easy installation. Secure and free data storage

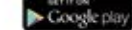

- **23506 iHEALTH LITE HS4 WIRELESS SCALE**
See specifications at page 3

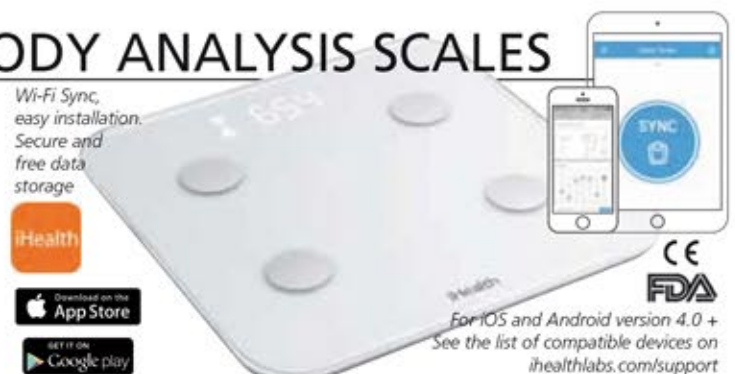

For iOS and Android version 4.0 +
See the list of compatible devices on ihealthlabs.com/support

- **23508 iHEALTH CORE HS6 WIRELESS BODY ANALYSIS SCALE**
See specifications at page 3

PRECISION SCALE



LCD rigid height 10.4 mm

27246

- **27246 PRECISION SCALE**
With tempered glass Ø 160x4 mm, tare function, kg/lb-oz.

TECHNICAL SPECIFICATIONS

Capacity: 5 kg (11 lb)
Sensitivity: 1 g
LCD display: 35x15 mm
Size: 185x158x50 mm
Battery: 1xCR2032 - not included

BODY FAT SCALE



- **27229 EXACTA DELUXE SCALE**
Measuring body weight, fat, water, muscle content and daily caloric consumption.

TECHNICAL SPECIFICATIONS

Capacity: max 180 kg (400 lb, 28 st)
min 3 kg (6.6 lb)
Sensitivity: 100 g (0.2 lb)
LCD Display: 31 mm
Safety glass: 310x310x22 mm
Battery: 2x CR2032 - included
Warranty: 3 years

SOEHNLE PROFESSIONAL DIGITAL SCALES

- 27275 SOEHNLE 7830
- 27276 SOEHNLE 7831 with height rod and BMI display
- 27277 SOEHNLE 7730 $\text{C} \text{E}$ M Class III

The new range of Soehnle professional personal scales with stand is a special highlight with its gently curved glass indicator. While stepping on the scale, the display is activated automatically and the weight is shown with red backlighted numbers. It does not require any operation and is perfectly suitable for simple weighing in medical institutions, wellness areas and pharmacies.

Scale with integrated height rod Soehnle 7831 (27276) with stand and height rod switches automatically from kg to cm if the height rod is raised. Thus, patients can be simultaneously weighed and measured.

Features:

- indication of weight, height and BMI (27276 only)
- integrated height rod from 120 cm to 202 cm (27276 only)
- simple to use, tare key on the back of the display
- glass scale indicator (glass thickness 8 mm)
- bright LED display: 5 digits, height 15 mm

Made in Germany.

Manual in: DE, GB, FR, ES, PT (only 27277), IT, NL, DK, FI, SE, NO, GR, TR, CZ, SK, PL, RU.

TECHNICAL SPECIFICATIONS

	27275	27276	27277
Capacity:	250 kg	250 kg	250 kg
Sensitivity:	100 g	100 g	50/100 g
Dimension mm:	365x490x890	365x490x1,280	365x490x890
Weight:	14.1 kg	17.2 kg	14.1 kg
Power Supply:	230 V - 50-60 Hz		

(available on request 110 V)

No keys on the glass plate



SECA MEDICAL SCALES - CLASS III



- 27284 SECA 756 - mechanical with height rod (60-200 cm) - class III
- Tradition combined with modern design. With a very sensitive precision mechanism to show weight through the aid of a well visible red pointer on the circular dial.
- User manual in GB, FR, IT, ES, DE, PT, PL, NL, GR, DK, SE, FI, NO.

TECHNICAL SPECIFICATIONS

Capacity: 160 kg
Sensitivity: 500 g
Weight: 18.5 kg
Dimensions: 628x360x1,000 mm
Platform: 360x350 mm with wheels

Keys to symbols:

M = Metrological Approval for use in medical field
C E C = Calibration according to class III sensitivity required by 90/384/EEC



- 27296 SECA 711 - mechanical with height rod (60-200 cm) - class III
 - 27297 SECA 700 - mechanical with height rod (60-200 cm)
- Mechanical column scale with weight adjustment at eye level. Weight can be measured in a conventional way: by aligning two chrome plated indicators.
- User manual in GB, FR, IT, ES, DE, PT, PL, NL, GR, DK, SE, FI, NO.

TECHNICAL SPECIFICATIONS

Capacity: 220 kg
Sensitivity: 100 g (27296) - 50 g (27297)
Weight: 21.7 kg
Dimensions: 520x1,556x520 mm
Platform: 350x360 mm



- 27292 SECA 799 - electronic with BMI - class III
 - 27298 SECA 220 HEIGHT ROD
- Versatile, low maintenance and site independent with economic battery operation, ideal for daily use in hospital and doctors practices. Column scale is easy to move around with its transport castors. BMI function permits a reliable evaluation of the nutritional conditions of the patient. Equipped with several functions: TARE, HOLD, weighing range switch-over, automatic switch off. User manual in GB, FR, IT, ES, DE, PT, PL, NL, GR, DK, SE, FI, NO.

TECHNICAL SPECIFICATIONS

Capacity: 200 kg
Sensitivity: 100 g < 150 kg > 200 g
Weight: 6.3 kg
Dimensions: 294x831x417 mm
Platform: 272x280 mm

C E C = Approved scales according to 93/42 EEC

PEGASO DIGITAL SCALE



Anodized aluminium telescopic height rod cm-inches with measurement range 75-210 cm and graduation of 0.5 cm



Switchable kg/lb.

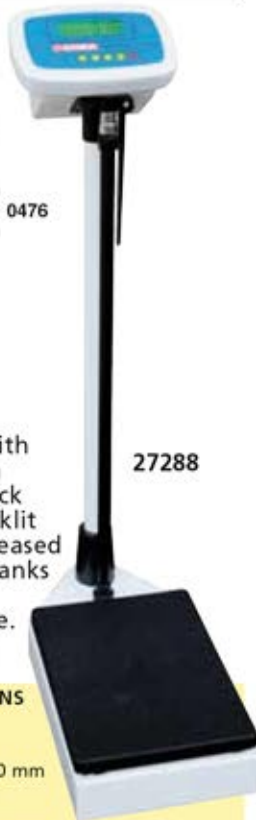

27288

• 27288 PEGASO DIGITAL SCALE with height meter (75x210 cm)

Professional and reliable digital scale with integrated height rod. Easy to use, each function has an on-screen display to track activities in real time. High contrast backlit LCD display with 20 mm figures for increased readability. Exact and reliable results thanks to tare and fixed weight functions. Auto-off function to avoid energy waste. Can be operated by mains or batteries.

• 27281 POWER SUPPLIER - spare

TECHNICAL SPECIFICATIONS

Capacity:	200 kg
Sensitivity:	100 g
Dimensions:	535x275x1,060 mm
Platform:	372x275 mm
Weight:	15 kg
Power supply:	110-240 V - 50/60 Hz
Battery accumulator:	6V 5AH
Recharging time:	4-5 hours
Operating time when fully charged:	36 hours

ASTRA SCALE



Reading on both sides of measuring rod 75 to 200 cm



27310

• 27310 ASTRA SCALE - 200 kg mechanical with height meter (75-200 cm)

Sturdy and reliable beam scale to warrant exact and precise measurements. Made in steel and varnished in high resistance white shellac. Robust lever system. Provided with wheels for easy mobility. User manual in GB, ES, FR, IT, DE, GR, PT, Arabic.

TECHNICAL SPECIFICATIONS

Capacity:	200 kg
Sensitivity:	100 g
Weight:	17 kg
Dimensions:	275x1,485x530 mm
Platform:	375x275 mm

Wheels for easy mobility

Platform with anti-skid cover

DIGITAL CHAIR SCALE

SOEHNLE
PROFESSIONAL

27273



• 27273 CHAIR SCALE SOEHNLE 7802

Fully electronic scale: no wear and tear parts, no maintenance. Easy to read display with 20 mm high figures. Zero setting, taring and hold functions. Tilttable arms for easy access of bed-ridden and frail patients. Powered by either mains or rechargeable batteries. Cable for recharging batteries included. Manual in: DE, GB, FR, NL, ES, IT, PT, CZ, FI, SE, NO, DK, GR, PL, TR.

TECHNICAL SPECIFICATIONS

Capacity:	200 kg (440 lb)
Sensitivity:	100 g
Total weight:	25 kg
Dimensions:	580x1,100x930 mm
Power supply:	230 V / 50-60 Hz, 10 mA, 2.2 VA
	Rechargeable batteries

Made in Germany

MULTIFUNCTION SCALE

SOEHNLE
PROFESSIONAL

Multifunction scale combined with 3 support handrails, a drive-on ramp and indicator bracket

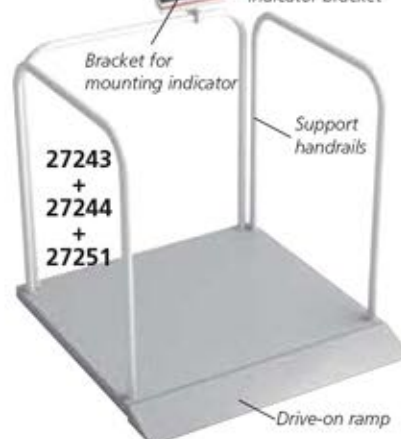

27243
+
27244
+
27251

Bracket for mounting indicator

Support handrails

Drive-on ramp

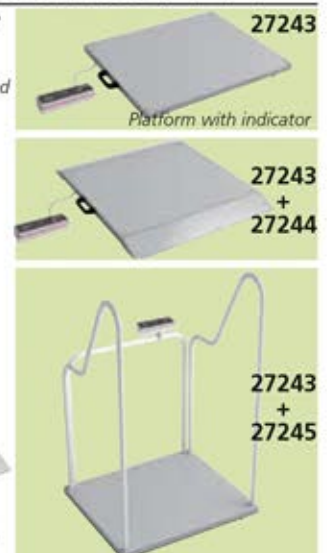

27243

Platform with indicator

27243
+
27244

27243
+
27245

• 27243 MULTIFUNCTION SCALE - SOEHNLE 7808

Manual in: DE, GB, FR, NL, ES, IT, GR, FI, NO, SE, DK, CZ, RU.

• 27244 DRIVE-ON RAMP

• 27245 ADIPOSITIVITY HANDRAILS + BRACKET FOR INDICATOR

• 27251 SUPPORT HANDRAILS + BRACKET FOR INDICATOR

• 27278 MULTIFUNCTION SCALE - SOEHNLE 7708 (€ M Class III (complete with 27244+27251) - manual in: GB, FR, DE

Multifunction scale prepared for easy (and later) mounting of support handrails, adiposity handrails, bracket for indicator, drive-on ramps. Movable by means of 2 rollers and handle. Large LCD display, digit height 20 mm. Made in Germany.

TECHNICAL SPECIFICATIONS

Capacity:	300 kg	Sensitivity:	100 g
Dimension:	840x880x55 mm	Weight:	16 kg
Power supply:	230 V - 50-60 Hz		
	(available on request with rechargeable battery or Class III)		

HOSPITAL DIGITAL BABY SCALE



- 27267 SECA 376 HOSPITAL SCALE - digital class III
- high-quality Seca scale technology with fine 5-gram graduation
- TARE, HOLD, auto-HOLD and BMIF for extra convenience
- extra large and ergonomic tray for safe weighing
- adjustable damping
- large display for easy reading
- network-capable with seca 360° wireless technology

TECHNICAL SPECIFICATIONS

Capacity: 20 kg Sensitivity: 5 g up to 7.5 kg, 10 g from 7.5 kg up
 Dimensions - weight: 620x190x358 mm - 3.7 kg
 Platform: 615 x 130 x 275 mm
 Battery operated

WIRELESS TECHNOLOGY - optional

With the seca 360° wireless technology the seca 376 can transmit measurements to the optional seca 360° wireless printer. With the network-capable software seca analytics 115 and wireless USB adapter seca 456, your PC can receive and analyze measurements and forward them to an Electronic Medical Records (EMR) system. Thus the seca 376 is EMR-integrated and ready to handle digital patient records and all the demands the future will bring. More information about EMR integration is at www.seca.com

HOSPITAL DIGITAL BABY SCALE



- 27263 SOEHNLE 7725 HOSPITAL SCALE - digital - Class III
- A two-range scale with high precision and reliability suitable for hospital use (approved class III, MPG class I). The damping and hold function guarantee a stable weight indication. With high stability for safe weighing of our babies. Easy to clean plastic and ergonomic forms allow a simple and hygienic cleaning.
- high-contrast LCD display with 20 mm high figures
- large reading angle
- automatic zeroing at switch-on
- tare function key

(laid on pad can be tared)
 - hold function
 Manual in: DE, GB, FR, ES, IT.

- 27264 BABY HEIGHT ROD
- Digital and mechanical rod, 35 to 80 cm, division 1 mm. Manual in 23 languages.



TECHNICAL SPECIFICATIONS

Capacity: 15 kg Sensitivity: 2 g up to 6 kg, 5 g from 6 kg up
 Dimensions - weight: 60x35x12 cm - 4.6 kg
 Operating voltage: 220-235 V/50-60 Hz or rechargeable batteries

SECA ELECTRONIC BABY SCALES



The weighing tray can be removed quickly and easily at the touch of a button

- 27282 SECA 354 - electronic
- 27283 SECA 384 - electronic - CE M Class III
- Two scales in one: with a comfortable tray to weigh in a reclining position, easily detachable to be converted into a floor scale. Breast-milk-intake function determines how much milk the baby has suckled. Other functions: tare, auto-hold, kg/lbs switch over automatic switch off, BMIF. User manual: GB, FR, IT, ES, DE (27282-3), PT, PL, NL, GR, DK, SE, FI, NO (27283 only).

TECHNICAL SPECIFICATIONS

Capacity: 20 kg Sensitivity: 10 g < 10 kg > 20g
 Dimensions: 552x156x332 mm Weight: 2.3 kg (27282), 2.8 kg (27283)
 Batteries operated Made in Asia

SECA MECHANICAL BABY SCALE



- 27299 SECA 725 - mechanical
- 27294 SECA 745 - mechanical - CE M Class III
- The sturdy classic: with its softly curved weighing tray, the stable all-steel casing and the precise, smooth running weights, this model is the indestructible original baby scale. User manual: GB, FR, IT, ES, DE, PT, PL.

TECHNICAL SPECIFICATIONS

Capacity: 16 kg Sensitivity: 5 g (27299) 10 g (27294)
 Dimensions: 550x180x290 mm Weight: 6 kg
 Made in Asia

PAPER SHEET FOR BABY SCALES

- 25250 PAPER SHEET for baby scales - flow pack of 25
- Pure wedding of cellulose, 2 plies (30+30 g/m²) + high density polythene (10 g/m²)



FOLDABLE BABY SCALE



- **27266 SOEHNLE 8320 FOLDABLE BABY SCALE**
Foldable baby scale for easy transport. Folding mechanism with magnetic lock. Easy to open: remove the base and pull the handles apart.
Taring function: pads, blankets placed under the baby are tarable.
Steady weight display through filtering and hold function.
Large LCD display easy to read.
Switchable to kg/lb.
Manual in: DE, GB, FR, ES, IT, GR, CZ, Arabic.
- **27271 CARRYING BAG**



27266

27271

HOME CARE BABY SCALE



Removable baby weighing tray

- **27306 SOEHNLE 8352 MULTINA DIGITAL BABY AND CHILD SCALE**
Well-designed, easy to handle baby scale made out of easy to clean plastic.
- detachable baby tray
- suitable to weigh children up to 20 kg removing baby tray
- easy to read LCD-display with 13 mm figures
- simple operation with one button
- fully-electronic scale: no wear and tear parts, no maintenance
- tare function to calibrate for baby blankets/textiles
- hold function: weight value will be held for 10 seconds after unloading
- automatic power-off to save battery capacity
- manual in: DE, GB, FR, IT, ES, NL, DK, SE, HU, FI, PT.
- **27307 TRAY FOR 8352 - spare**



27306

TECHNICAL SPECIFICATIONS

Capacity: 15 kg Sensitivity: 10 g
Dimensions: 395x315x105 mm (closed) - 740x315x53 mm (open)
Alkaline battery 2x1.5 V AAA - not included
Weight: 1.9 kg Warranty: 2 years

TECHNICAL SPECIFICATIONS

Capacity: 20 kg Dimensions: 601x346x92 mm
Battery operated: 9 V Sensitivity: 10 g Weight: 3.5 kg
Warranty: 2 years Made in Germany

BABY AND CHILD SCALE



Multilanguage box in: GB, FR, IT, ES, PT, PL, DE, RO, CZ, HR, HU, LV, EE, SK, SI.

- **27312 BABY AND CHILD DIGITAL SCALE**
Multifunctional scale for babies and children with removable light plastic tray. It can be used with tray for babies or without for children.
Weight difference display function with memory: you can see the gain of weight of the baby after feeding.
Precise scale with easy-to-read LCD display.
Auto zero, auto tare, auto hold function.
Automatic switch off and low battery indicator.
Switchable to kg/lb/st. Manual: GB, FR, IT, ES, PT, DE.
Made in Europe.



27312

TECHNICAL SPECIFICATIONS

Tray dimensions: 525x305x63-95 mm Capacity: 20 kg
Pack dimension: 540x300x110 mm Sensitivity: 10 g
Battery operated: 2xCR2032 lithium batteries Weight: 2 kg

GIMA ELECTRONIC BABY SCALE

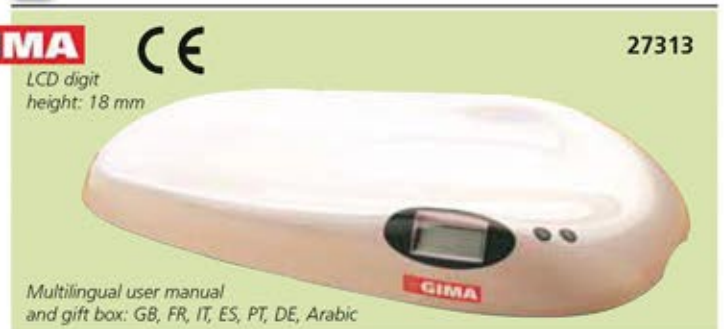

LCD digit height: 18 mm

Multilingual user manual and gift box: GB, FR, IT, ES, PT, DE, Arabic

- **27313 GIMA ELECTRONIC BABY SCALE**
Handy, reliable and well-designed electronic baby scale.
Provided with large LCD display 66x28 mm and kg/lb switch.
Supplied with height tape meter and washable sheet.



27313

TECHNICAL SPECIFICATIONS

Capacity: 20 kg / 44 lbs Sensitivity: 10 g
Dimensions: 595x340x90 mm Weight: 4 kg
Battery operated: 4x1.5 V AA Auto-off function

FAMILY BABY SCALE

- **27301 FAMILY BABY SCALE**
Baby scale suitable for domiciliary use.
Capacity 20 kg/44 lbs
Scale division: - 50 g (0-10 kg)
 - 100 g (10-20 kg)
Plastic tray. Dialplate in kg and lbs. Manual zero adjustment.
Multilanguage manual: GB, FR, IT, ES, PT, DE, Arabic.



CE 0476

27301

VISIOFOCUS® AND VISIOFOCUS® PRO "NON CONTACT" THERMOMETERS



VisioFocus® is the most advanced thermometer to precisely measure body temperature. Totally hygienic, **without touching the skin**, VisioFocus® reads infrared radiation naturally emitted by the surface of the skin and calculates the whole body temperature.



- 25573 VISIOFOCUS®
 - 25574 VISIOFOCUS® PRO
- High accurate "non contact" thermometer that projects the temperature on the forehead.

Advantages of VisioFocus®:

- exclusive patented aiming system guarantees correct point and distance
- projection of the temperature on the forehead
- face button automatically adjusts forehead temperature to the environment (room) temperature for accurate result
- exclusive and patented AQCS and MQCS systems to maintain correct and constant temperature of device during long periods of use or when moving between rooms with different temperatures
- clinically tested
- totally hygienic for patients and users: no touch & no disposables
- no laser: absolutely safe for travellers and users, no harm if the person eyes are open while measurement is taken
- CE, FDA, Koseisho, TGA, CFDA (VisioFocus®), CE (VisioFocus® Pro)
- instantaneous: gives temperature in less than 1 second



25573

- Nurs and Doct functions (only 25574) for pandemic situations: allow to take temperature of up to 1,000 travellers per hour. Nurs has obliged MQCS every 30 minutes, Doct has automatic AQCS
- low using cost thanks to the long battery life and speed of measurement that allows to reduce the number of thermometers and of operators necessary for a wide screening
- Made in Italy

Visiofocus® is supplied with batteries and manual (GB, FR, IT, ES)



25573

25574

Visiofocus® Pro is supplied in a case with lanyard, batteries and manual (GB, FR, IT, ES)

BACKLIGHTED DISPLAY IN 5 DIFFERENT COLOURS, ONE FOR EACH FUNCTION

BODY TEMPERATURE	OBJECTS	MEMORY	AMBIENT	CALIBRATION MQCS

TECHNICAL SPECIFICATIONS

Forehead measuring range	34.0 /42.5°C (93.2/108.5°F)
Measuring range (apart from forehead)	1.0/80°C (33.8/ 176°F)
Room temperature working range	16/40°C (50/104°F)
Can work also in environments with a temperature between 10 and 16°C (50/60.8°F) and between 40 and 45°C (104/113°F) but in this case the accuracy is reduced	
Resolution	0.1°
Accuracy level	According to ASTM E 1965-98:2009
Distance of operation:	About 6 cm (2.36")
Batteries (included)	4 AAA/LR03 type (preferably alkaline)
Batteries life	<30,000 measurement
Measurement time	<0.5 seconds
Time between consecutive measurements	<2 seconds

NON CONTACT THERMOMETER



- 25591 INFRARED NON CONTACT THERMOMETER
- Multifunctional infrared non contact thermometer for body and objects.

Effective distance 5-15 cm.

Body temperature with fever teller
Wide range 32.0-42.9 °C (89.6-109 °F) and green, yellow, red backlight.

Object temperature 0-100 °C (32-212 °F)
Body object function for ambient temperature, milk or bath surface temperature.

Fever alarm

32 memories

Instant response time: 1 second

Auto/manual power off.

Supplied with 2AAA batteries.

Size 160x95x46 mm.

Display 30x31 mm.

Reading scale °C/°F switchable

Multilanguage box and manual: GB, FR, IT, ES.

FEVER TELLER



Green backlight



Yellow backlight



Red backlight

FOREHEAD THERMOMETER

- 25585 INFRARED MULTI-FUNCTION FOREHEAD THERMOMETER
- 32212 SPARE BATTERY

Multifunctional innovative infrared thermometer with 5 applications: forehead temperature, room temperature, scan mode for surface temperatures (bath water or milk), real time clock, stopwatch.

- friendly 3 LED zone indicator to get fever status
- instant measurement
- large LCD to read easily
- detailed 9 memories with time/date & site
- fever alarm with beeper
- selectable °C/°F mode
- small size to carry when travelling
- accurate: ± 0.2/0.3 °C
- self-diagnosis warning when device is abnormal.



3 LED Fever Indicator

CE 0476

Packed in deluxe card board box.

TECHNICAL SPECIFICATIONS

Measurement range:	- forehead: 34.0 °C-42.2 °C (93.2 °F-108.0 °F)
	- scan mode: -22/80 °C (-7.6-/176 °F)
Response time:	5-30 sec
Time between measurements:	> 5 sec
Display Model	°C/°F
Battery Type:	CR2032 (32212)
Dimension (LxWxH) - Weight:	14x3.8x3 cm - 70 g
Norms:	IEC60601-1, IEC60601-1-2 (EMC), ASTM E1965-98



25585

5 APPLICATIONS



☐ THERMOFOCUS® PROFESSIONAL "NON CONTACT" THERMOMETERS

THERMOFOCUS THERMOMETERS

The most advanced thermometers in the world! Thermofocus reads infrared radiations emitted by the surface of the skin and calculates accurately the body temperature.

- **without touching:** never in contact to avoid any risk of infection
- **non invasive:** does not require patient collaboration, recommended for children
- **accurate:** a sophisticated microprocessor ensures high precision
- **economic:** no need of expensive probes
- **fast:** takes the temperature in less than one second
- **1 °C-55 °C:** for measurement of wide range of objects
- **body temperature scan (25571/2):** can be done quickly

• 25570 THERMOFOCUS - mod. 0700A2 - 2 buttons - blister **FOR FAMILY**

For the private user who needs an easy, fast and precise thermometer. Simply press the ON button, hold it perpendicular to the centre of the forehead and release the button as soon as the two red lights converge in a single point. It can also be used to take the temperature of objects such as a baby's feeding bottle. Not recommended for doctors and hospitals.

• 25571 THERMOFOCUS - mod. 1500 - 6 in 1 - 3 buttons **FOR DOCTORS**

For the family or the private doctor who require maximum accuracy and flexibility of the temperature taking. Same as 25570 with an additional button ("home") to read the ambient temperature and the skin temperature (professional use), as well as the temperature of objects and liquids within a range from 1 to 55 °C (33.8 to 131 °F). Provided with the exclusive Manual Quick Calibration System (MQCS) technology through which you can always perfectly stabilize the thermometer to the ambient temperature.

• 25572 THERMOFOCUS - mod. 1500A/ H1N1 3 buttons **HOSPITAL-EMERGENCY**

Specifically studied for hospitals, airports, schools, factories, etc. in case of emergency and/or pandemic situations. Quick, accurate and easy to use, allows a fast and hygienic temperature reading for thousands of consecutive measurements. Same as 25571, but with



A patented optic-aiming system allows to immediately find correct distance for measurements.

compulsory MQCS technology (Manual Quick Calibration System), through which you can always perfectly stabilize the thermometer to the ambient temperature, ready to take series of measurements. Supplied with a lanyard to be worn around the neck.

• 32200 "AAA" BATTERIES

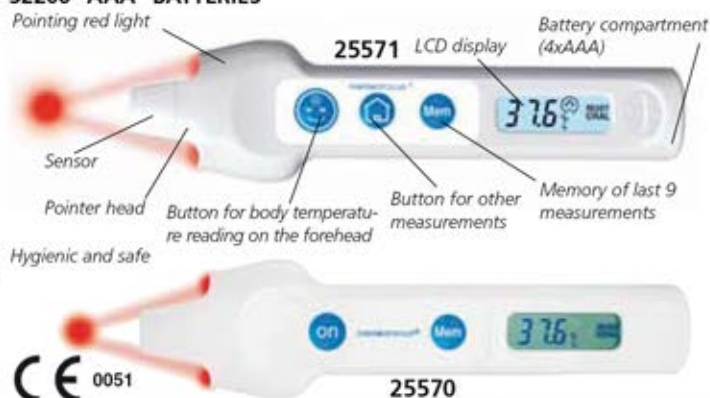

Hygienic and safe

TECHNICAL SPECIFICATIONS

Forehead measuring range:	34.0/42.5 °C (93.2/108.5 °F)
Measuring range (apart from forehead):	1.0/55.0 °C (33.8/131 °F)
Ambient temperature working range	16/40 °C (60.8/104.0 °F)*
Precision:	0.1 °C (0.2 °F)
Accuracy level according to ASTM E 1965-98:	
from 34 to 35.9 °C (93.2/96.6 °F)=	±0.3 °C (±0.5 °F)
from 36 to 39 °C (96.8/102.2 °F)=	±0.2 °C (±0.4 °F)
from 39.1 to 42.5 °C (102.4/108.5 °F)	±0.3 °C (±0.5 °F)

Distance of operation: 3 cm (1.2 inch) fixed through optical signal

* The thermometer can work also in environments with a temperature between 5 and 16 °C (41/60.8 °F), but we do not guarantee the accuracy.

Battery: 4xAAA (1.5V) included Weight: 99 g Size: 165x40x22 mm

Manual: GB, IT, FR, ES only for 25570-1. On request: PL

Soft manual available on request: FR, ES, DE, DK, NO, NL, PT, FI, S, TR, GR, RU, AR, KR
Made in Italy

THERMOFOCUS 5 IN 1



☐ EAR THERMOMETER

- 25580 IR EAR THERMOMETER
- 25581 PROBE COVERS - box of 40 pcs.
- 32212 SPARE BATTERY
- fully meet "ASTM" standard and CE EN 12470-5 (only few brands passed it) in measurement accuracy (35.5 °C to 42 °C ± 0.2 °C, others ± 0.3 °C).
- unique and handy design
- one-second measurement, fast and easy
- 9 memory for temperature comparison and evaluation, fever alarm, easy reading LCD display
- self-diagnostic and infrared measurement



25581

25580



TECHNICAL SPECIFICATIONS

Measurement Range:	34.0 °C-42.2 °C (93.2 °F-108.0 °F)
Response time:	1 second
Time between measurements:	> 5 sec
Display Model	°C/°F
Battery Type:	CR2032 (32212)
Dimension (LxWxH):	- Weight: 14x3.8x3 cm - 70 g
Norms: IEC60601-1, IEC60601-1-2 (EMC), ASTM E1965-98	

CE 0476

☐ PROFESSIONAL THERMOMETER

- 25575 PROFESSIONAL INFRARED EAR THERMOMETER
- 25576 PROBE COVERS - box of 200 pcs. (5 tubes of 40 pcs.)
- 25577 PROBE COVERS LOADER **HOSPITAL USE**
- special design for hospital use
- durable probe for cover replacement up to 100,000 times
- probe cover ejector and probe cover detector
- one-second response time: fast and easy
- neck strap and 1 probe cover included
- fever alarm
- selectable °C/°F

Needs probe covers for use



Probe cover ejector



Probe cover loader



Large LCD display

25575

TECHNICAL SPECIFICATIONS

Measurement range:	34-42.2 °C (93.2-108 °F)
Accuracy:	±0.2 °C (0.4 °F) during 35.5-42 °C (95.9-107.6 °F), ±0.3 °C (0.5 °F) for other range
Memory:	25 sets
Buzzer:	Yes
Battery:	CR2032 1 (Gima code 32212)
Dimension - weight:	144.82x39.84x48.50 mm - 68.8 g

ECOLOGICAL THERMOMETERS - MERCURY FREE

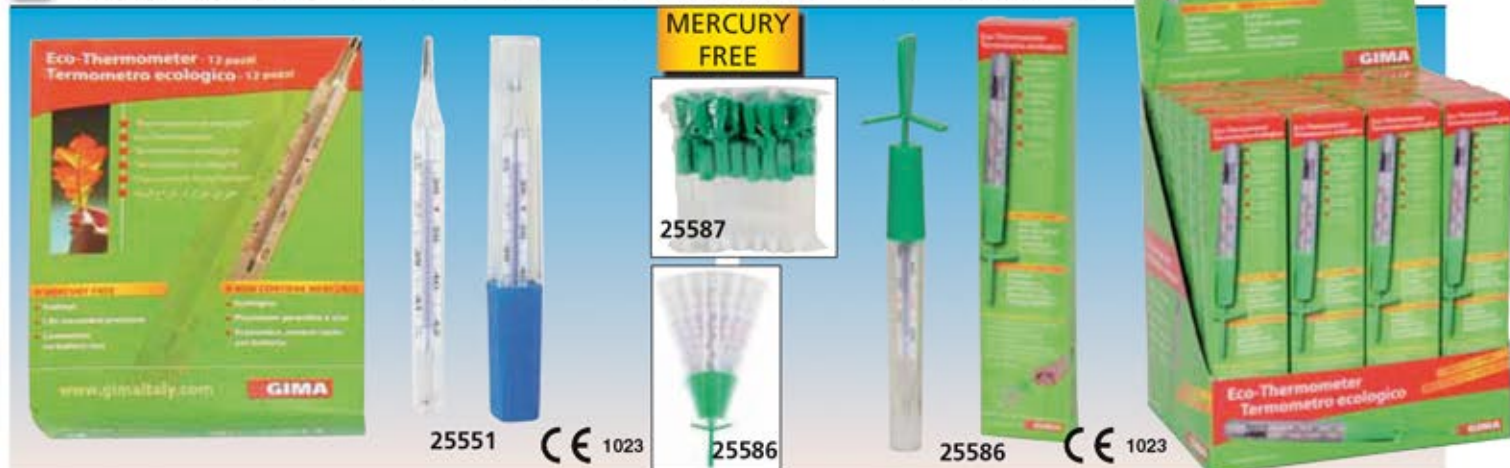

- 25551 ECOLOGICAL OVAL THERMOMETER - box of 12
 - 25587 SHAKER for ecological thermometers - box of 24
- Mercury free clinical thermometer with gallium alloy instead of mercury. Safe, precise and functional. Glass structure.

- 25586 ECOLOGICAL OVAL THERMOMETER with shaker - box
 - 25589 ECOLOGICAL OVAL THERMOMETER with shaker display box of 24 pcs.
- Same as 25551 but supplied with a shaker to help shake down gallium after use.

POCKET EAR THERMOMETER

- 25579 POCKET EAR THERMOMETER
- Small, easy to clean, cover free design ear thermometer. Home use.

TECHNICAL SPECIFICATIONS	
Measurement Range:	34-44 °C (93.2-111.2 °F) - ±0.2 °C (±0.4 °F)
Response time:	1-2 seconds
Battery:	Lithium 3 V (CR2032) - life approx 4,000 measurements
Size - weight:	114x35x40 mm - 35 g (including batteries)



WIRELESS THERMOMETER

- 25548 TEMP SITTER - baby wireless thermometer
- Accurate and innovative thin thermometer. Transmission to mother smartphone APP (iOS and Android). To be placed under baby armpit. High temp alarm can be set in the APP. Waterproof and material of safe quality. Supplied with 10 adhesives to fix thermometer to baby armpit.
- 25547 ADHESIVE TO FIX TEMP SITTER - box of 10 - spare



BABY THERMOMETERS

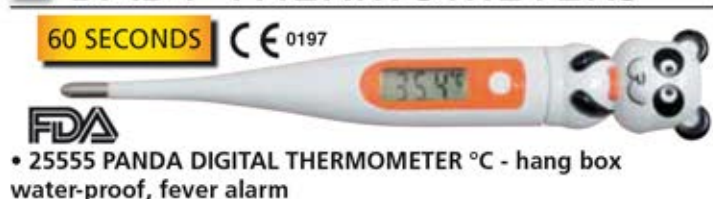

NIPPLE-LIKE DIGITAL THERMOMETER

- 25569 NIPPLE-LIKE DIGITAL PACIFIER THERMOMETER °C
- Individually packed in cardboard box, memorizes last temperature. Auto power-off. Display range 32.0°C - 42.0°C, with accuracy ±0.1°C. 1.5 V button battery included.



LIQUID CRYSTAL THERMOMETERS

Non toxic, mercury free, safe, unbreakable, reliable, long lasting, easy to read, liquid crystal thermometers. 10 languages manual. Made in Italy.

REUSABLE FOREHEAD THERMOMETERS

- 25599 FEVERTEST - bag of 10 blister
 - 25596 FEVERTEST BULK - box of 100 - hospital use
 - 25600 FEVERCONTROL - bag of 10 blister
- It indicates the normal temperature or fever in 15 seconds. It indicates temperature in 15 seconds with graduation of 0.5 °C. Safe, fast, accurate, non toxic, unbreakable.

BODY TEMPERATURE MONITOR

- 25601 48h FEVER MONITOR - bag of 10 blister of 3 pcs.
- Innovative "continual" fever indicator for 48h monitoring.



DIGITAL THERMOMETERS

60 SECONDS



25564

- 25564 GIMA VALUE DIGITAL THERMOMETER °C - box - rigid tip

30-60 SECONDS CE 0197



25559

- 25559 GIMA DIGITAL THERMOMETER °C - box - 30 seconds
- Sold in a counter display of 36 pcs. (GB - IT)
- 25560 GIMA DIGITAL THERMOMETER °C - hang box - 60 seconds
- 25561 GIMA DIGITAL THERMOMETER °F - hang box - 60 seconds (89,6-107,6 °F)

60 SECONDS CE 0197



- 25557 FLEXI JUMBO 2 DIGITAL THERMOMETER °C - hang box, flexible tip, water-proof resistant, fever alarm

30 SECONDS CE 0476



- 25562 W-P DIGITAL THERMOMETER °C - hang box water-proof

30 SECONDS CE 0476



- 25563 FLEXI DIGITAL THERMOMETER °C - hang box flexible tip, water-proof

22 SECONDS



25552

- 25552 WIDE SCREEN DIGITAL THERMOMETER - box flexible tip, large display 27x22 mm. Battery 1.5 V button size

10 SECONDS BACKLIGHT



25553

- 25553 BL1 WIDE SCREEN DIGITAL THERMOMETER - box flexible tip, water-proof, backlight after measurement, wide display (27x22 mm). Battery 3 V button size. Low battery indicator.

BATH THERMOMETER



25567

CE 0476

- 25567 BATH THERMOMETER °C - Star
- Measures water temperature in 90 sec.
- Measurement range 0 to 70° C.
- Supplied in hang blister.



25560

25558

Counter display of 36 pieces 25559

GIMA DIGITAL THERMOMETERS

Available in °C or °F, provide accurate and quick read-out.

Safe and easy to use with clear and large display.

- display range: 32.0-42.9°C (25556-7, 25559-60, 25562-4, 25552-4) 32.0-42.0°C (25558)

- accuracy $\pm 0.1^{\circ}\text{C}$ ($\pm 0.2^{\circ}\text{F}$)
- memory: last reading
- beeper function and auto shut-off
- plastic case
- multilanguage manual and box (GB, FR, IT, ES, PT, GR) 25556, 25557 have also PL, Arab

- 25549 BATTERY 1.5 V LR/41 - box of 20 for all thermometers except 25558, 25553, 25554

10 SECONDS CE 0197 FDA



- 25558 FLEXI JUMBO DIGITAL THERMOMETER °C - hang box flexible tip, water-proof, fever alarm, backlight jumbo display (31x14 mm size). Battery CR1220 3 V.

8 SECONDS CE 0197



- 25556 INSTANT DIGITAL THERMOMETER °C - hang box, flexible tip, water-proof, fever alarm, large display

20 SECONDS GREEN/ORANGE/RED BACKLIGHT



Lower than 37.1 °C will show green. Between 37.2 and 37.9 °C will show orange. Between 38.0 °C and 43.9 °C will show red mean fever

Battery 3 V button size (CR2032)



- 25554 BL3 WIDE SCREEN DIGITAL THERMOMETER - blister flexible tip, water-proof, red/orange/green backlight after measurement, wide display 29.3x15.3 mm. Low battery indicator

BASAL THERMOMETER

- 25608 DIGITAL BASAL THERMOMETER °C - hang box - water-proof
- With 4 digits, 2 decimals, for fertility control

CE 0476

4 DIGITS, 2 DECIMALS



25608

MANUAL AND ELECTRIC LICE COMB

Natural, ecologic method to eliminate completely lice and nits without any harm. Ideal for allergy sufferers and children.

• **24400 MANUAL LICE COMB - blister**
Ergonomic comb with long metal teeth and a detachable cleaning brush with built-in magnifier. The long, delicately closed teeth of the comb are designed specifically to detach lice and their nits (tiny eggs). The round form of the touching point respects the growth direction of the hair without harming its texture. Multilanguage blister: GB, FR, IT, ES.

Free display box any 10 blister



24400

Detachable cleaning brush with built-in magnifier



24400

• **24402 ELECTRIC LICE COMB**

This innovative product removes and kills lice and nits with a quick increasing electrical discharge of 130-180 Volts from the teeth, imperceptible and harmless to humans. Auto switch off. Provided of buzzer indicator and cleaning brush. Supplied with 2 AAA batteries.



24402

STOPLICE ANTI-LICE AND NITS SHAMPOO

• **24404 STOPLICE ANTI-LICE AND NITS SHAMPOO - 250 ml - box of 20**

Stoplice Shampoo is designed with special formula to get rid of nits and lice. The mechanical effect of tea tree oil, helps eliminating lice and nits. D-panthenol and aloe vera take care of hair and prevent the deterioration of the scalp. This product is suitable for all hair types. Apply by foaming and gentle massage, leave on hair for 10-15 minutes and rinse with warm water. Hair should be combed carefully to make sure all the nits and lice are cleaned. It is recommended to have at least two applications. Seven days after the first application, if necessary (if you come across nits again) repeat treatment.



24404

DEVICES AGAINST INSECTS, MEDUSAE, SNAKE BITES

25771 CE 0051



• **25770 ZANZA-CLICK AFTERBITE - IT - green**

• **25771 ZANZA-CLICK AFTERBITE - GB - blue**

A few clicks to soothe the irritation caused by mosquito bite and nettles.



• **25772 BABYFRIEND**
Ultrasonic repelling device against mosquitos.



• **25773 ECOSAVE**

Electronic stimulator against snake bites or poisonous stings of insects and fishes.

Few electric shocks are enough to reduce toxic reaction.



CE 0051

DENTAL HYGIENE

• **36655 GERMORAL MOUTHWASH - bactericidal mouthwash**

One display contains 12 bottles of 300 ml
For daily oral hygiene, Germoral prevents and acts against the formation of bad breath because it stops fermentation in the oral cavity. It performs an essential antiplaque and hygienic action. Particularly suitable for smokers, prothesis or paradontic teeth users or after dental surgery for disinfecting the oral cavity. If regularly applied it prevents and acts against inflammations, gingival disorders, dental plaque formation.



36655

UNSTINGER®

• **24395 UNSTINGER®**

Insect poison extraction tool. An easy and painless way to avoid the discomfort that follows from bites and stings by bees, wasps, hornets and even scorpions or snakes. Reusable one-hand operated vacuum pump which easily and painlessly extracts poison and venom from a sting or bite.



24395

TICK TWEEZER



• **24390 TICK TWEEZER**

SPLINTER



• **24391 SPLINTER WITH MAGNIFYING GLASS 2X - 8 cm**

PHARMADOCT FIRST AID, MEDICATION AND WELLNESS



All products are in blister with 7 languages package (GB, FR, IT, ES, DE, PT, GR) except 25332, 25380/82/90 (only GB, FR, IT, ES, DE)

code	PHARMADOCT LINE	Pieces per box	Minimum order*	code	PHARMADOCT LINE	Pieces per box	Minimum order*
25300	Classic plasters - 7x2 cm	20	12 box	25316	Herpes patch	15	12 box
25301	Classic plasters - 5 assorted sizes**	30	12 box	25318	Nasal strips	10	12 box
25302	Classic plasters - 6 assorted sizes***	100	12 box	25372	Ear plugs	4	12 box
25305	Hypoallergenic plasters - 5 assorted sizes**	30	12 box	25350	Corn plasters	10	12 box
25307	Hypoallergenic plasters - 2 (7.5x7.5), 2 (7.5x10)	4	12 box	25351	Oval corn plasters	9	12 box
25310	Children plasters "tattoo" 10 (6x2), 6 (7x3.8)	16	12 box	25352	Blister plasters	5	12 box
25312	Plasters with hemostatic gauze	20	12 box	25370	Dental floss	1	12 box
25314	Hand plasters - 5 (12x2), 5 (7x2), 4 (butterfly)	14	12 box	25380	Lip balm classic	1	12 box
25320	Dressing strip 100x6 cm	1	12 box	25382	Lip balm strawberry	1	12 box
25322	Cloth roll - fabric - 5 mx1.25 cm	1	18 box	25360	Nail scissors	1	12 box
25324	Cloth roll 5 mx2.5 cm	1	12 box	25361	Cuticle clipper	1	12 box
25335	First aid - kit of 8 different products	8	8 box	25362	Nail file	1	12 box
25330	Cotton gauze swabs 18x40 cm	6	12 box	25363	Tweezer	1	12 box
25332	Elastic bandages 4 mx6 cm	2	6 box	25364	Small nail cutter	1	12 box
25337	Adhesive elastic compression bandage 2.5 m x 6 cm	1	6 box	25390	Condoms	12	8 box

*Minimum order is carton of "....." boxes, each one containing "....." pieces

**10 (7x2), 10 (4x1), 2 (3.8x3.8), 4 (7x2.4), 4 (Ø 2.5)

***30 (7x2), 20 (4x1), 20 (7x2.4), 10 (Ø 2.5), 14 (6x2), 6 (3.8x3.8)

QUALITY PILL SPLITTERS AND PILL PULVERIZERS

These easy tools are ideal for elderly people, children and hospital attendants. Useful also for medicating pets. They avoid dispersion of medicine and guarantee integrity of the dose. Easy to clean, also in dishwasher. Made in non-toxic, unbreakable material.

- 25729 PILL SPLITTER - bulk
- 25730 PILL SPLITTER - with box
- 25743 ULTRA PILL SPLITTER - blister

Accurately divide tablets, large and small pills for reduced dosage or easier ingestion. Simple to operate. Top quality products, made in Europe (25729-30), USA (25743)

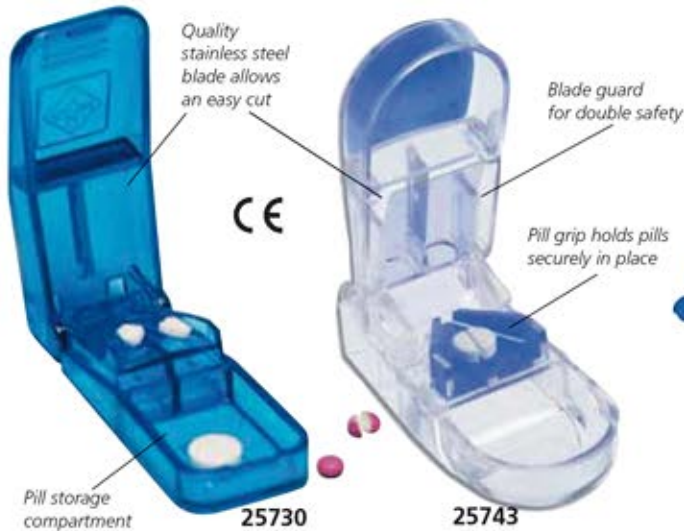

- 25747 DISPLAY FOR SPLITTER (25730) PULVERIZER (25731) - empty (English language)

Suitable for 4 pill splitters and 4 pill pulverizers. Available in any language on request.

- 25731 PILL PULVERIZER - with box
- 25744 ULTRA PILL PULVERIZER - blister

Powerful pulverizing point, powders pills of any shape and size, with an easy twist of the wrist.



Multilanguage box and instructions: GB, FR, IT, ES, DE, PT, PL, GR

MIXED COLOURS PILL SPLITTERS - BOX OR DISPLAY



- 25748 PILL SPLITTER - box of 12 pcs
This box includes 12 pill splitters in 4 colours: light blue, green, transparent lavender and transparent orange.
- 25749 PILL SPLITTER - display box of 12 pcs
Counter display box including 12 pill splitters in 4 colours (light blue, green, transparent lavender and transparent orange) in a single cardboard box.

25749



COMBO SPLITTER-CRUSHER PILL BOX TIMER



- 25766 COMBO PILL MANAGER 4 IN 1
Four functions in a practical device: pill splitter, pill crusher, pill box and water cup.

25766

- 25765 PILL BOX TIMER
Pocket pill box timer in ABS material, size 90x50x19 mm, supplied in cardboard box with batteries. Double pill box space to store pills and tablets. It reminds when you have to take your medication with a countdown up to 19 hours and 59 minutes.



25765



VIALS OPENER

- 25739 VIALS OPENER - box of 20
A practical tool to help opening vials in a safe way.

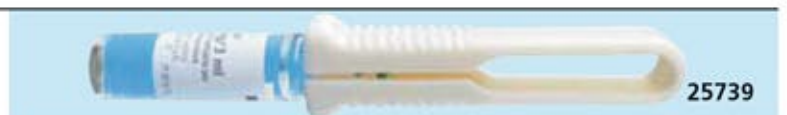

25739

PILL BOXES: 7 DAYS AND SINGLE DAY PLANNERS

- 25751 7-DAY TOWER PLANNER - GB, FR
 - 25753 7-DAY TOWER PLANNER - IT, DE
 - 25755 7-DAY TOWER PLANNER - ES, PT
- Available in any other language minimum 2,000 pcs (available in 90 days).

Size: 13x11x3.5 cm



25751



7 detachable
4-compartment boxes
(morning, noon, evening, night)
Size: 10.5x3.5x1.5 cm

- 25732 - 7 DAYS PILL BOX blue translucent

Translucent top enables the user to see if medication has been taken



It comes with one set of labels for individual marking of compartments in 11 languages (GB, FR, IT, ES, DE, PT, PL, GR, HU, RO, SE)

With 7 detachable 4 compartments small boxes (morning, noon, evening and night)

- 25757 TWICE A DAY PLANNER - IT
 - 25759 TWICE A DAY PLANNER - GB
- 2 translucent colours



25757



25759



25760

- 25758 7-DAY MEDI PLANNER - IT
 - 25760 7-DAY MEDI PLANNER - GB
- 4 translucent colours

Contoured design for easy pill removal



25758



Holds up to 50 pills

L M M G V S D Q P C N
T T W J F S D Q P S

Supplied with a set of labels for each day suitable for 6 languages: GB, FR, DE, IT, ES, PT



25750



25735



25752



25734



25756

- 25750 PILL BOX pack of 2 pcs - blue/pink - blister
- 25735 DAILY PILL BOX - yellow - box
- 25752 DAILY PILL BOX - blue translucent - blister
- 25754 DAILY PILL BOX - white - blister
- 25734 WEEKLY PILL BOX - white - box
- 25756 WEEKLY PILL BOX - white - blister

	25750	25735/25752	25734	25732	25757/25759	25758/25760	25754	25756
English language printed on pill boxes	yes	-	-	yes	yes	yes	yes	no
Labels in other languages*	-	-	yes	11 languages	-	-	-	-
Colour	blue/pink	yellow/blue	white	translucent	translucent	translucent	white	white
Compartments	2	6	7	28(4x7)	14(2x7)	28(4x7)	4	7
Size cm	7x5x2	8x5.5x1.5	13x2.5x2	17x12x2	18.5x9.5x3	21x14.5x3.5	9.5x2x2	15.5x3x2
Package	blister	box/blister	box	box	box	box	box	blister
*Supplied with a set of labels with day in 6 languages (English, French, German, Italian, Portuguese, Spanish) and 1 white label for compartment for individual marking.								

☐ EASY LIFE: AIDS FOR DAILY LIVING



- **28920 CUTLERY SET**
 - **28921 BENDABLE CUTLERY SET**
- Set of 4 pieces (knife, fork, tea and table spoon). Made in stainless steel with thick, ribbed rubber handle (10 cm) for easy grip



- **28925 SPOON & FORK HOLDERS - pack of 2 pcs.**
- These portable, stylish holders fit onto virtually any style spoon and fork providing a secure grip (spoon and fork are not included).



- **28966 DRINKING GLASS - box of 210**
- Drinking glass made of polypropylene with a separated tap and a lip. Capacity 250 ml graduated by 25 ml. Autoclavable. Can be disinfected in washer. Not for microwaves



- **28901 PENCIL GRIP - pack of 2 pcs.**
- Rubber grip for pens or pencils. Helpful aids for elderly or disabled people. These cushions are designed in both shape and density to alleviate stress while providing a secure grip.



- **28950 EASY OPENER**
- This all in one product easily opens bottle caps, pull tabs, and even those impossible box tops! Designed to provide safety for the user.



- **28951 JAR OPENER & CLOSER**
- This uniquely designed product concentrates hand power to remove lids and turn facets effortlessly.



- **28945 SHOPPING BAG CARRIER**
- This product provides an effort-free handle that remains constantly supportive, regardless of bag loads.



- **28906 MAGNIFYING GLASS**
- Magnifies two times larger than original size. Large enough to do what's needed, yet small enough to be totally portable, fitting easily into purse or pocket.



- **28912 SOCK AID NOTCH**
- Soft terry cloth on one side grips the sock, while smooth nylon on the other side reduces friction, allowing your foot to slip in easily. Two long loop handles are easy to hold and assist with pulling the sock onto your foot. Ideal for those who have the use of only one hand or with decreased strength or coordination.



- **28911 ZIPPER AND BUTTON PULLER**
- For those with weak or arthritic fingers, there's probably no more difficult task than fastening a button! This unique product eliminates the frustration by pulling the button or zipper into position. Folds to half-length to fit easily into pocket or purse.



- **28940 EASY KEY TURNER pack of 2 pcs**
- These enlarged key turners are designed with the turning effort already begun, so completion of the turn is accomplished with minimal effort. Two different colours per package.



- **28941 MULTIPLE KEY TURNER**
- Designed to assist person with limited wrist strength or movement. People with arthritis or other limited hand mobility can manipulate keys with ease. House keys and most car keys (without plastic head covers) fit into the slots and are held by a single screw.



- **28963 GRASPING TOOL - foldable**
- Your extended reach grasping tool will help you to eliminate bending or climbing for those hard-to-reach items. Length: 80 cm, foldable in 2. Locking tab holds the item in place.

- **28915 LONG BATH SPONGE**
- Lightweight sponge feature soft polyfoam attached to a plastic handle. Available with contoured sponge.



- **28960 GRASPING TOOL - 3 WAYS - 66 cm**
- Aluminium body, PP handle. Three grasping ways: steel hook, magnetic tip, rubber head.

SOAPED SPONGE, SOAPED AND NON SOAPED WASH GLOVE



36660

• **36660 SOAPED SPONGE - box of 500**
Disposable sponge in foam soaked with anallergenic, neutral PH soap. Ideal for patient cleaning and hygiene. Individually packed.
Size: 7.5x12xh 2.5 cm



36663

• **36663 SOAPED WASH GLOVE - box of 50**
Disposable mitten to wash patient. Made in non woven and sponge, soaked with liquid soap with neutral PH and anallergenic. Ideal for patient cleaning and hygiene.
Size: 15x25 cm



36661

• **36661 WASH GLOVE - box of 1,000**
Disposable wash glove to clean patients. Made in special airlaid, which allows to soap and rinse patient, and waterproof PE. Embossed surface allows a deep cleaning. Size: 16.5x22 cm. Made in Italy.

SKIN SOAP

• **36671 FRAGRANCE SKIN SOAP - 1,000 ml**

Delicate skin protective. Fragrance soothing bath and shower with moisturizer active agents, respects the lipid mantle and it is delicate on skin leaving it fresh and pleasantly soft. It is used for daily hygiene as a normal liquid soap, suitable for personal hygiene, bath, shower and shampoo. Suitable for frequent washing and very sensitive skins too, it protects and soothes sensitive skin of children and elderly people. Fast to be rinsed leaves a fresh cleanness sensation. Sold in box of 12 pcs, only 2 pieces come with dispenser pump.



• **36690 DISPENSER PUMP**

GERMELLA

• **36672 GERMELLA - 1,000 ml**

Germella is a skin-protecting liquid detergent combining the properties of three extraordinary medical plants: **Camomile, Sage and Aloe**. Camomile and Sage and have moisturizing and soothing qualities. Aloe Vera's main property is soothing. Moreover Aloe makes your skin soft and velvety. Thanks to the Camomile, Sage and Aloe extracts, Germella is a delicate detergent, which respects the natural defence of skin and mucous membranes. Thanks to its natural ingredients Germella is also particularly suitable for daily intimate care. Sold in box of 12 pcs, only 2 pieces come with dispenser pump.



BIBS WITH POCKET

Size: 38x28 cm
+ 10 cm (pocket)

Extremely soft and comfortable

Large pocket



36666

Easy fastening on patient by laces

• **36666 BIBS WITH POCKET - box of 600**
Disposable bibs made of 1 ply of highly absorbent wadding of cellulose and 1 ply of waterproof blue polyethylene. Box of 600 (6 bags of 100). Made in Italy.

HOT-COLD GEL

Individually packed in single box

34114



• **34114 HOT-COLD THERMO GEL**
Size: 14x28 cm - box of 30 pcs.
Special gel keeps temperature (hot or cold) for long time.

HOT WATER BOTTLES

Capacity 2,000 cc



28600

28601

• **28600 HOT WATER BOTTLE - British standard - blue**
100% made of rubber, latex free.
• **28601 HOT WATER BOTTLE 2 l - red**
25% made of rubber, latex free. Both are two side ribbed. Packed in plastic bag with multilanguage user manual (GB, FR, IT, DE, ES, PT, GR).

ICE BAGS

Neck of bag: PP

Neck of bag: aluminium



28605

28606

• **28605 ICE BAG - Ø 28 cm - large top cap O.D. 8.78 cm, I.D. 6 cm - light blue**
Made of polyester fabric + PVC, latex free. Single packed in carton box, with multilingual manual (GB, FR, IT, DE, ES, PT, GR).
• **28606 ICE BAG - Ø 28 cm - small top cap O.D. 7.15 cm, I.D. 4.7 cm - blue**
Made polyester fabric + PVC. Single packed in transparent bag with multilingual manual (GB, FR, IT, DE, ES, PT, GR)

ELECTRIC HEATING PAD

• **28655 ELECTRIC HEATING PAD** Suitable for many applications.
• **28656 ELECTRIC "SAND" HEATING PAD**

The use of purified marine sands make it possible to naturally transmit their beneficial warmth.

Heating: position 1 up to 42°C in 30 min, position 2 up to 66°C (max 56°C first hour, up to 66°C following hours)

External cover in cotton (94%) and nylon, internal bag in PVC
Operating power: 230 V - 50/60 Hz - 75 W (28656) - 55 W (28655)



Sold in 4 languages box (GB, FR, IT, ES)

Size: 38x30 cm

GRADUAL COMPRESSION, UNISEX, COTTON SOCKS

UNISEX GRADUAL COMPRESSION COTTON SOCKS

High quality knee socks made from soft cotton combined with elastic fibres to provide proper gradual compression. Special attention was dedicated to the development of this cotton product line in order to ensure maximum fibre quality, along with an extremely soft elastic cuff that offers high levels of expandibility: all to ensure maximum comfort and wellness throughout the day.

This product line also offers two different compression levels (medium and strong) and is available in two colours (black and blue). On request, for quantities (minimum 100 socks) available also light and extra strong compression and beige and grey colours.

Medium compression level: 14-16 mm/Hg at the ankle

To help prevent discomfort and heaviness in the legs.

Composition: 67% cotton, 26% polyamide, 7% elastane.

High compression level: 15-21 mm/Hg at the ankle

To help prevent the onset of venous disease.

Composition: 63% cotton, 27% polyamide, 10% elastane.

It is a Medical Device. Made in Italy.



Multilanguage box and instructions:
GB, FR, IT, ES, PT, DE, GR, HU

GRADUAL COMPRESSION COTTON SOCKS					
MEDIUM COMPRESSION SOCKS					
Colour	Small	Medium	Large	X-Large	XX-Large
Black	41220	41221	41222	41223	41224
Dark blue	41225	41226	41227	41228	41229
STRONG COMPRESSION SOCKS					
Colour	Small	Medium	Large	X-Large	XX-Large
Black	41240	41241	41242	41243	41244
Dark blue	41245	41246	41247	41248	41249
Shoe size					
European	37 - 39	39 - 41	41 - 43	43 - 45	45 - 47
US - Men	5 - 6½	6½ - 8	8 - 9½	9½ - 11	11 - 12½
US - Women	6½ - 8	8 - 10	10 & over	-	-



SUPPORT SHEER LINE

Knee Socks, Stockings and Tights designed for dynamic women who need the preventive action of elastic compression but don't want to compromise on style.

This elegant product line features a true heel, an anti-shrink cuff and extremely soft fabrics.

This line offers two different compression levels (medium and strong) and is available in beige or black.

Medium compression level: 70 den - 10-14 mm/Hg at the ankle

Ideal for those who would like to initiate a prevention programme, but are mainly interested in the comfort and well-being offered by elastic compression stockings.

Composition: 84% polyamide, 16% elastane (Stay ups, Pantyhoses).
85% polyamide, 15% elastane (Knee-highs).

Strong compression level: 140 den - 15-21 mm/Hg at the ankle
Ideal for those suffering from the initial signs of ankle swelling and discomfort.

This level of compression is also highly indicated in case of initial onset of varicose veins. The product's compression level supports and massages the leg, thus providing effective relief throughout the day. While this product line boasts an extremely elegant design, particular attention has also been dedicated to maximum elasticity, which is ensured through the use of a honeycomb fabric (net fabric).

It is recommended to ask the advice of a physician prior to use. Composition: 79% polyamide, 21% elastane.

These products are Medical Devices. Made in Italy.



Multilanguage box and instructions:
GB, FR, IT, ES, PT, DE, GR, HU

Knee-high with a gradual compression, comfort top, honeycomb mesh



Multilanguage box and instructions: GB, FR, IT, ES, PT, DE, GR, HU

Stay ups with gradual compression, silicone lace top, honeycomb mesh



Multilanguage box and instructions: GB, FR, IT, ES, PT, DE, GR, HU

Pantyhose with gradual compression, reinforced body, honeycomb mesh

KNEE-HIGHS		
MEDIUM COMPRESSION		
Colour	Small/Medium	Large/X-Large
Black	41100	41101
Beige	41102	41103
STRONG COMPRESSION		
Colour	Small/Medium	Large/X-Large
Black	41106	41107
Beige	41108	41109

STAY UPS				
MEDIUM COMPRESSION				
Colour	Small	Medium	Large	X-Large
Black	41120	41121	41122	41123
Beige	41124	41125	41126	41127
STRONG COMPRESSION				
Colour	Small	Medium	Large	X-Large
Black	41132	41133	41134	41135
Beige	41136	41137	41138	41139

PANTYHOSES					
MEDIUM COMPRESSION					
Colour	Small	Medium	Large	X-Large	XX-Large
Black	41150	41151	41152	41153	41154
Beige	41155	41156	41157	41158	41159
STRONG COMPRESSION					
Colour	Small	Medium	Large	X-Large	XX-Large
Black	41165	41166	41167	41168	41169
Beige	41170	41171	41172	41173	41174

ANTI-EMBOLISM ELASTIC STOCKINGS - MADE IN ITALY

A line of stockings dedicated to prophylaxis of thromboembolism before, during and after surgery. Thanks to their descending graduated compression, these stockings represent an excellent means of preventing increased blood viscosity, which can lead to the formation of thrombus.

In order to guarantee a good fit and properly graduated compression, a great deal of attention has been dedicated to ensuring the high elasticity of the fabrics.

Indications:

- a valid aid in preventing thromboembolisms linked to surgical interventions.
- treatments associated with post-traumatic therapies.

- bruises, sprains and hydrostatic edemas

Contraindications:

- localized dermatitis, erythema, necrosis
- stripping, pulmonary edema, grafts
- vascular disorders of cardiac origin
- legs of larger circumference

Features:

- decreasing compression from the ankle to the thigh
- true anatomic heel
- extremely soft and elastic fabric, hypoallergenic (latex free)
- inspection opening on top of the foot

Composition: 82% polyamide, 18% elastane.

These products are Medical Devices.



Antiembolism below knee stocking with inspection hole

Multilanguage bag and instructions: GB, FR, IT, ES, PT, DE, GR, HU

BELOW KNEE

COMPRESSION mm/Hg 18-20 (at the ankle)	Length	Small	Medium	Large	X-Large
38-43 cm		41310	41311	41312	41313



Antiembolism thigh length with inspection hole and silicone top

Multilanguage bag and instructions: GB, FR, IT, ES, PT, DE, GR, HU

THIGH LENGTH

COMPRESSION mm/Hg 18-20 (at the ankle)	Length	Small	Medium	Large	X-Large
60-70 cm		41316	41317	41318	41319
70-80 cm		41320	41321	41322	41323
80-90 cm		41324	41325	41326	41327



Antiembolism full length stocking with inspection hole adjustable top, ambidextrous

Multilanguage bag and instructions: GB, FR, IT, ES, PT, DE, GR, HU

FULL LENGTH

COMPRESSION mm/Hg 18-20 (at the ankle)	Length	Small	Medium	Large	X-Large
70-80 cm		41330	41331	41332	41333

SOFFISOF INCONTINENCE PADS - MADE IN ITALY

Multilanguage package: GB, FR, IT, ES, DE, PT, Arabic



36701 - 36705

SOFFISOF CLASSIC AND AIR DRY INCONTINENCE PADS

Elasticated incontinence pads anatomically shaped, for moderate to high incontinence level. Air dry pads have breathable backsheet. These high absorption incontinence pads offer maximum comfort thanks to their special shape, especially designed to fit perfectly

Medium	Large	SOFFISOF CLASSIC
36701	36702	Moderate incontinence-day
36704	36705	Heavy incontinence-night

AIR BREATHING

36707
36711

user's body. Lateral borders guarantee maximum security against any liquid leak and adhesive tapes make it easy to wear and use. Odour control thanks to combination of a last generation polymer and special kind of cellulose, 100% PEFC certified cellulose. Moderate incontinence: box of 90 (6 boxes of 15) Heavy incontinence: box of 60 (4 boxes of 15)

Medium	Large	SOFFISOF AIR DRY
36707	36708	Moderate incontinence-day
36710	36711	Heavy incontinence-night

AIR BREATHING

36715 - 36716

SOFFISOF PANTS/PULL-UP - box of 84 (6 boxes of 14)

Practical disposable absorbable pant wearable as normal underwear for moderate to high incontinence level. Made of soft breathable non woven fabric to guarantee maximum comfort. It fits user's body to offer discreet and high protection against leakages.

Medium	Large	SOFFISOF PANTS/PULL-UP
36715	36716	Moderate incontinence-day

Suitable for autonomous people who live an active life; ideal also for patients during their recovery phase or during neuromotorial rehabilitation.

SOFFISOF ABSORBENT BED PADS

- 36720 SOFFISOF ABSORBENT BED PAD - 60x90 cm - box of 90 (6 boxes of 15)
- 36721 SOFFISOF ABSORBENT BED PAD - 80x180 cm - box of 90 (6 boxes of 15)

Absorbent bed pads in 2 different sizes.

100% PEFC certified cellulose.

They assure high absorption and protection to bed.



BATH/SHOWER CHAIRS



27730

• **27730 SHOWER CHAIR with backrest**
Aluminium frame, seat and backrest in plastic material. Height adjustable (35-45 cm), non slip end. Load: 100 kg.



42906

• **42906 REINFORCED SHOWER CHAIR with backrest**
Aluminium frame, seat and backrest in plastic material. Height adjustable (42-52 cm), non slip end. Load: 150 kg.



42907

• **42907 SHOWER CHAIR with backrest and armrest**
Aluminium frame, seat and backrest in plastic material. Height adjustable (41-54 cm). Load: 100 kg.

BATH STEPS



42920



42921

• **42920 BATH STEP - 1 step**
• **42921 BATH STEP - 2 steps**
Stainless steel frame and plastic steps. Size: 27x41xh 14 cm (42920). Size: 51x41xh14-29 cm (42921). Load: 100 kg

SHOWER COMMODE WHEELCHAIR



42915

• **42915 SHOWER COMMODE WHEELCHAIR**
Foldable shower commode wheelchair with aluminium frame and plastic seat. Flip-up armrest and lockable front castors. Size: 75x44x48 cm. Weight: 6 kg. Load: 100 kg.

BATH CHAIR



27755

• **27755 SWIVEL BATH CHAIR**
Revolving bath chair at 360° with 4 positions for easier access to bath. Polypropylene seat. Frame in painted steel, rotation system in stainless steel. Load: 100 kg. Weight: 5.5 kg. Made in Italy.

BATH SEAT



42910

• **42910 BATH SEAT - adjustable**
Aluminium frame and plastic seat (41x23 cm). Load: 100 kg.

BATH/SHOWER STOOLS



27733

Adjustable seat 54.4 - 71.6 cm with 8 heights adjustments, by 2.5 cm (1" increment)

• **27733 ADJUSTABLE SWIVEL STOOL WITH HANDLE**
- easy tool-free installation
- swivel seat with 90 degree position lock at every right angle location
- non-slip central seat pad and soft under-covers
- load 135 kg (300 lbs)



42900

• **42900 SHOWER STOOL - fixed**
Shower stool with aluminium frame and plastic seat 50x30 cm. Height adjustable 35-45 cm. Non slip end. Load: 100 kg



42901

• **42901 SHOWER STOOL - foldable**
Shower stool with aluminium frame and plastic seat 50x30 cm. Height adjustable 44-47.5 cm. Non slip end. Load: 100 kg



42903

• **42903 SHOWER STOOL**
Shower stool with aluminium frame and plastic seat Ø 32.5 cm. Height adjustable 38-56 cm. Non slip end. Load: 100 kg.

RAISED TOILET SEATS - MADE IN EUROPE



27750 Fixed armrest

• 27750 RAISED TOILET SEAT height 12.5 cm with fixing system (front screw) and fixed armrest made in anodized aluminium. Max load 130 kg (286.6 lb). Packing: 410x165x468 mm

Size: 36.5x40.5 cm



27741

Instructions: GB, IT, FR, ES, DE, PT, GR, SE, DK, PL, NL

• 27741 ARES RAISED TOILET SEAT - 10 cm with lateral fixing system. Max load 225 kg (495 lb). Packing: 373x128x410 mm



27751 Reclining armrest

• 27751 RAISED TOILET SEAT height 12.5 cm with fixing system (back and front screw) and anodized aluminium reclining armrest. Max load 130 kg (286.6 lb). Packing: 410x165x468 mm



27740

Instructions: GB, IT, FR, ES, DE, PT, GR, SE, DK, PL, NL

• 27740 ARES RAISED TOILET SEAT - 14 cm with lateral fixing system. Max load 225 kg (495 lb). Packing: 373x165x410 mm



27756

• 27756 CLIPPER RAISED TOILET SEAT - 11 cm Easily adapt to any toilet bowl. Totally made of injected plastic. 4 fixation clips to secure strongly the seat on the toilet bowl. Max load 185 kg (407 lb).



27735

Instructions: GB, IT, FR, ES, DE, PT, GR, SE, DK, PL, NL

• 27735 ARES RAISED TOILET SEAT with LID - 10 cm
• 27737 ARES RAISED TOILET SEAT with LID - 14 cm with lateral fixing system. Max load 225 kg (495 lb). Packing: 373x128x410 mm (27735) 373x165x410 mm (27737)

SAFETY SUCTION GRAB BARS



28974



28972



28973

GREEN means well attached
RED is a warning signal. Need re-mount
SAFETY VISIBLE

• 28972 SAFETY GRAB BAR - 443 mm
• 28973 SAFETY GRAB BAR - 545 mm
• 28974 SAFETY DOUBLE GRAB BAR - 929 mm
Innovative line of GRAB BAR, can be quickly installed everywhere without need of drilling and screwing. Patented suction cups (Ø 93 mm). Holds up to 60 kg (28972/3) or 85 kg (28974) vertical and 45 or 60 kg (28974) lateral weight (tested by SGS). Ideal solution to support elder people during daily bathroom use. Top quality product made of heavy duty ABS, with patented "green/red" suction indicator for better safety.

PLASTIC RIBBED GRAB BAR



28977

28976

• 28975 PLASTIC RIBBED GRAB BAR - 30 cm
• 28976 PLASTIC RIBBED GRAB BAR - 45 cm
• 28977 PLASTIC RIBBED GRAB BAR - 60 cm
Ribbed plastic grab bar in Medical PVC, complete with ABS mounting plates and screw covers. Wall screws not included. Electrically isolated. The ribbed bars offer excellent anti-slip grid and are warm to the touch. Can be mounted either horizontally or vertically. Tube Ø 3.5 cm. Max user weight 120 kg (205 lb). Manual: GB, IT. Made in Italy.

U-SHAPE STEEL GRAB BAR



28979

• 28979 U-SHAPE STAINLESS STEEL GRAB BAR - 70 cm
White powder coated wall mounted lift up toilet support. Designed to help getting up or transferring to and from the toilet. It can be folded upwards for easy accessibility. Max user weight 125 kg (275 lb). Supplied without wall screws. Manual: GB, IT. Made in Italy.



WALKING STICKS



- 27779 "T" HANDLE ALUMINIUM WALKING STICK - bronze
Adjustable height: 72-94 cm - weight 0.4 kg - max load 120 kg
- 27780 "T" HANDLE ALUMINIUM WALKING STICK - silver
Adjustable height: 71-94 cm - weight 0.36 kg - max load 100 kg
- 27781 "T" HANDLE ALUMINIUM WALKING STICK - black
Adjustable height: 67-90 cm - weight 0.3 kg - max load 100 kg
- 27782 FOLDABLE ALUMINIUM WALKING STICK - coffee
Adjustable height: 80-90 cm - weight 0.37 kg - max load 100 kg
- 27783 FOLDABLE ALUMINIUM WALKING STICK - cashmere pattern
Adjustable height: 86-96 cm - weight 0.36 kg - max load 110 kg
- 27784 CURVED HANDLE ALUMINIUM WALKING STICK
Adjustable height: 77-100 cm - weight: 0.32 kg - max load 100 kg
- 27795 RUBBER TIP int. Ø 19 mm - grey for 27780-2, 27793 - bag of 5
- 27796 RUBBER TIP int. Ø 15 mm - grey for 27790, 43070 - bag of 5

QUADRIPODS AND STICK WITH SEAT



- 43060 STICK WITH SEAT - silver
Aluminium walking stick with seat, height 84 cm, weight 0.9 kg
- 43065 TRIPOD - silver
Adjustable height 74-97 cm, weight 0.8 kg
- 43070 QUADRIPOD Q1 with PU handle - aluminium - silver
Adjustable height 74-97 cm, weight 0.9 kg
- 43071 QUADRIPOD Q2 with small base and PU handle - silver
Adjustable height: 65-88 cm, weight 0.8 kg
- 43072 QUADRIPOD Q3 with PU handle - bronze
Adjustable height: 70-88 cm - weight 0.5 kg
Maximum load for tripod and quadripods: 100 kg
- 27796 RUBBER TIP int. Ø 15 mm - grey for 43065, 43070/72 - bag of 5



QUALITY STICKS MADE IN ITALY



- BEECHWOOD STICKS:**
- 27760 GIOTTO CURVED HANDLE - man - brown
 - 27761 GIOTTO CURVED HANDLE - woman - brown
 - 27762 RAFFAELLO "T" HANDLE - man - brown
 - 27763 RAFFAELLO "T" HANDLE - woman - brown
 - 27764 TIZIANO CURVED HANDLE - unisex - brown
 - 27765 TIZIANO "T" HANDLE - unisex - brown
 - 27768 LEONARDO METAL CURVED HANDLE - unisex - black
 - 27769 LEONARDO METAL "T" HANDLE - unisex - black
 - 27772 TIEPOLO CHROMED "DUCK" HANDLE - unisex - black
- Max load for wooden sticks: 100 kg. Height: 92 cm'.
*Depending on rubber tip and handle can change from 90 to 94 cm

QUALITY STICKS MADE IN FRANCE

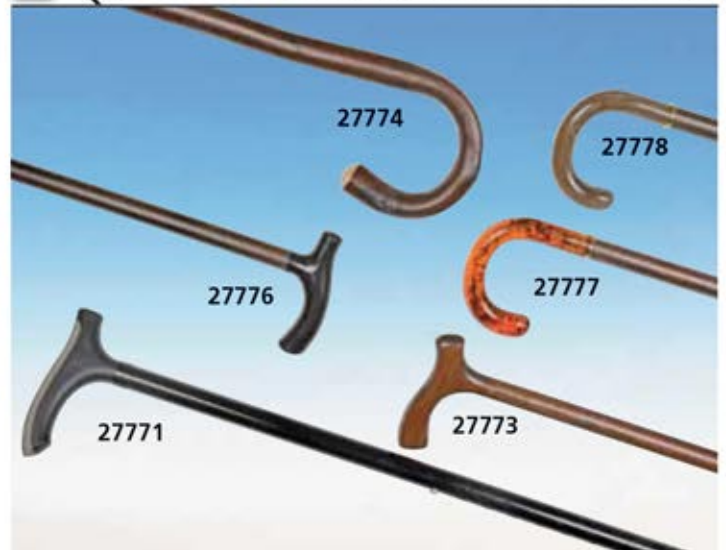

- WOODEN STICKS**
- 27773 "T" HANDLE - wooden - maximum load 120 kg
 - 27774 CROOK - chestnut - maximum load 100 kg
- SYNTHETIC STICKS**
- 27776 "T" HANDLE - black - load 120 kg
 - 27777 CROOK - amber style - load 100 kg
 - 27778 CROOK - horn style - load 100 kg
- ADVANCED WALKING STICK**
- 27771 "T" ADVANCE - grey
Aluminium height adjustable cane 745-975 mm with comfortable gel-grip to reduce hand stress. Maximum load 110 kg



ELBOW CRUTCHES MADE IN FRANCE



43100 43101 43102 43110 43115

- 43100 EVOLUTION CRUTCHES - black/grey - pair
 - 43101 EVOLUTION CRUTCHES - blue/grey - pair
 - 43102 EVOLUTION CRUTCHES - orange/grey - pair
- Ergonomic handle and brachial support to enhance safety and quality of arm support while moving around.
- 43110 PROGRESS 2 CRUTCHES - light grey/grey - pair
- For tall and heavy-weight adults, the handle adjusts from 22 to 29 cm. This crutch is suitable for adults whose height is comprised between 160 and 215 cm.
- 43115 TIKI CRUTCHES - blue/orange - pair
- For children or teenagers. The handle adjusts from 17.5 to 20 cm.
- 43120 RUBBER PVC TIP inside Ø 19 mm - grey - bag of 10

TECHNICAL SPECIFICATIONS

Model	EVOLUTION	PROGRESS 2	TIKI
Weight kg:	0.5	0.5	0.5
Height handle to floor cm:	76-100	76-100	52-74
Material of handle:	Polypropylene		
Diameter upper/down pipe mm:	22/19	22/19	22/19
Number of adjustment of height:	10 times adjustable every 20 mm		
Finishing/material:	grey anodization/aluminium		
Certified and tested for kg:	130	150	100
Standard used for testing:	EN ISO 11199-1		
Adjustable handgrip:	-	4 times	3 times
Handgrip size: Ø x l x h mm	35x100x235	35x100x220/290	32x100x175/200

T-BAR AND ELBOW CRUTCHES



- 27793 FOREARM CRUTCH
- Lightweight aluminium tube. Anatomic handgrip. Height adjustable 96-119 cm. Weight 0.55 kg. Max load 100 kg
- 27792 T-BAR CRUTCH - small
- Stainless steel type. Adjustable height: 95-115 cm. Max load 100 kg
- 27798 T-BAR CRUTCH - medium
- Stainless steel type. Adjustable height: 112-132 cm. Max load 100 kg
- 27799 T-BAR CRUTCH - large
- Stainless steel type. Adjustable height: 119-139 cm. Max load 100 kg
- 27770 T-BAR CRUTCH - extra adjustability
- Aluminium crutch with adjustable height 100-130 cm. Max load 100 kg
- 27797 RUBBER TIP int. Ø 22 mm grey for 27792/8/9 - bag of 5

SKID-PROOF STICKS WITH LIGHT

- 43044 TRUSTY CANE - silver
 - 43045 TRUSTY CANE - black
- Sturdy, folding cane with built-in lights and extra wide pivoting head with 3 firm and skid-proof bases. Height adjustable 85-97 cm. Large base with Ø 9 cm. Shaft in aluminium (thickness 1.2 mm) Handle in ABS (15 cm). Weight 420 g. Need 3x1.5 V AAA batteries not included.
- 43048 FOOT PADS - kit of 3 - spare



STICKS WITH LIGHT AND ALARM



- 43050 SAFETY LIGHT STICK - black
 - 43052 SAFETY LIGHT STICK - skid proof base - black
- Innovative sticks with safety light and alarm.
- front ultra-bright white 4 LED light up to 15 lumen, with adjustable positions
 - ultra-bright red LED warning flash with 2 LED, up to 5 lumen
 - ABS hand grip and aluminium frame
 - 100 dB warning siren
 - adjustable height: 10 positions from 78 to 100.5 cm
 - extra wide 360° pivoting base (43052 only)
 - stands on its own (43052 only)
- Works with 2 AAA batteries, not included. Maximum load: 110 kg



ROLLATORS

Wheels
Ø 10 cm (4")

CE

Foldable



- **27721 ROLLATOR**
Size 54x57 cm with adjustable height 52-87 cm.
Weight: 8 kg - Load: 100 kg.



- **43132 ROLLATOR WITH SEAT**
Blue painted steel adjustable height 79-93 cm frame with padded seat.
Size: 52x49 cm. Weight 6.4 kg - Load: 100 kg.



Foldable to save space

WALKING FRAME

CE



- **27722 WALKING FRAME**
Made of lightweight aluminium tubing, non-slip end and padded handgrips.
Size 47x60 cm foldable with adjustable height 78-96 cm.
Weight: 2.4 kg - Load: 100 kg.
- **27794 RUBBER TIP Ø 28 mm - grey for 27722-3 - bag of 5 pcs.**

WALKING FRAMES WITH WHEELS

CE



- **27723 WALKING FRAME - 2 WHEELS**
Made of lightweight aluminium tubing, with padded hand grips, 2 non-slip ends and 2 with wheels.
Size 51x64 cm, foldable with adjustable height 79-97 cm.
Weight: 3 kg - Load: 100 kg.
- **27794 RUBBER TIP Ø 28 mm - grey for 27722-3 - bag of 5 pcs.**



- **43129 WALKING FRAME - 2 INTERNAL WHEELS**
Made of lightweight aluminium tubing with padded hand grips, 2 non-slip ends and 2 with wheels. Foldable.
Size 51x58 cm
Adjustable height 80-90 cm.
Weight: 2.5 kg - Load: 100 kg.



2 rear wheels with braking function: press to stop



- **43130 WALKING FRAME - 4 WHEELS**
Made of lightweight aluminium tubing, 2 front swivel wheels, 2 rear wheels with stop, with foam grips.
Size 55x65 cm foldable with adjustable height 83-93 cm.
Weight: 3.5 kg - Load: 100 kg.

FOLDING SHOULDER WALKER

- **43136 FOLDING SHOULDER WALKER - adjustable height**
Blue painted steel, foldable shoulder walker with chromed and padded, height adjustable shoulder support. Supplied with 4 castors, 2 of them with brake. Optional padded seat and brachial support. Made in Italy.
- **43137 PADDED SEAT**
- **43138 BRACHIAL SUPPORT**

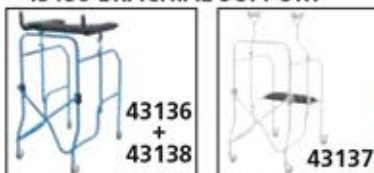

Seat height: 50 cm



ROTATING SEAT CUSHION

- **43040 ROTATING SEAT CUSHION**
Cushion to assist to turn easily in a car, from the bed or on the chair.
Size: Ø 40 cm



Slippery nylon filled with PU foam

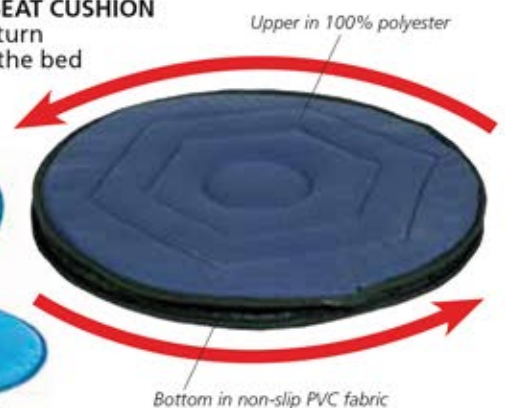

Upper in 100% polyester

Bottom in non-slip PVC fabric

CE ROLLATORS



43140

Wheels
Ø 20 cm (8")

- **43140 3 WHEELS ROLLATOR - blue**
Blue painted steel, adjustable height frame. With 3 solid castors (2 fixed rear with brake and 1 swivel front). Supplied with shopping basket and tray. Weight: 7.7 kg - Load: 100 kg.

Height
adjustable
78-93 cm

43142

Wheels
Ø 20 cm (8")

- **43142 IDEAL ROLLATOR - blue**
Blue painted steel, adjustable height foldable frame. With 4 solid castors (2 fixed rear and 2 swivel front). Ergonomic and adjustable handle and hand brakes. Supplied with padded seat, shopping basket and tray. Weight: 12.5 kg - Load: 100 kg. Carton size: 590x290x680 mm



27724

Front pivoting castors:
Castors Ø 20 cm (8")

68 cm

61 cm

- **27724 COMFORT ROLLATOR WITH SEAT - foldable**
With seat, large front basket and brakes on wheels. Size 68x61 cm. Adjustable height 78-90 cm. Seat at 46 cm. Seat size: 32x35x4 cm. Weight 7.4 kg - Load: 100 kg.



43143

- **43143 SILVER ROLLATOR WITH SEAT - foldable**
With seat, large front basket and brakes on rear wheels. Size 68x61 cm. Adjustable height 78-90 cm. Weight 7.4 kg - Load: 100 kg.



43145

- **43145 LEISURE ROLLATOR - foldable**
Powder coated aluminium frame, grey colour. Comfortable cotton belt backrest and nylon seat. Height adjustable handles from 84 cm to 95 cm. Up-down bidirectional brake. Solid tires Ø 20 cm (8"). Provided with nylon shopping bag. Weight: 8.2 kg - Load: 100 kg.

□ PEDAL EXERCISERS

These pedal exercisers are compact exercise bikes. The regular use stimulate blood circulation and increase muscle



43150

- **43150 BASIC PEDAL EXERCISER**
Supplied disassembled with screw and key for easy assembling. Multilanguage box and manual: GB, FR, IT, ES, PT, DE, PL, GR

strength: it is a great way to enjoy a moderate cardiovascular workout. Can be placed on a tabletop to exercise arms



43151

- **43151 DISPLAY PEDAL EXERCISER**
Folding type to save space when not in use. Provided with 5 function display: exercise time, rotation count, rotations per minute, calories burned and scan.

or on the floor to enjoy a bicycle-type exercise from your chair.



43152

- **43152 ELECTRIC PEDAL EXERCISER**
Display indicator: scan, mode, calories, time, Reps, total Reps. Power 220 V - 50 Hz - 65 W.

ELITE COMMODE WHEELCHAIRS - MADE IN ITALY



Same features as 43201 with adjustable height, without wheels



- 43201 ELITE 110 COMMODE - 42 cm
- chromed steel frame
- blue, washable, flame retardant leatherette
- plastic pan
- 4 pivoting wheels Ø 8 cm (2 with brake)
- adjustable height footrest
- can be placed over WC

- 43203 ELITE 200 COMMODE - 43 cm
- 43204 ELITE 200 COMMODE - 53 cm
- chromed steel frame
- blue, washable, flame retardant leatherette
- plastic pan
- 4 wheels Ø 20 cm (2 with brake)
- adjustable length and raising footrest
- removable armrest
- reclining backrest

- 43199 ELITE 50 CHAIR
 - 43210 UNIVERSAL TRAY
 - 43212 WHEEL Ø 20 cm - front - spare
 - 43213 WHEEL Ø 20 cm - rear - spare
 - 43216 BELT
 - 43217 BELT with strap
- Sturdy and washable polypropylene belts. Quick mounting.

	TECHNICAL SPECIFICATIONS		
	ELITE 50	ELITE 110	ELITE 200
Size (cm):	52x60xh 70/78	52x80xh 100	54x88xh 105
Seat height	46/54 cm	50 cm	53 cm
Seat width	42 cm	42 cm	43 or 53 cm
Weight	20 kg	20 kg	21 kg
Load	90 kg	90 kg	100 kg

COMMODO CHAIRS

- 27701 COMMODO CHAIR - chromed steel
- Chromed steel chair frame, with plastic detachable commode seat.
- 27702 COMMODO WHEELCHAIR - painted
- Powder coated steel frame, detachable armrest and footrest, solid rear castors with lock, plastic commode seat.
- 27703 COMMODO WHEELCHAIR - stainless steel
- Stainless steel chair frame, detachable armrest and footrest, rear castors with lock, plastic commode seat.
- 27699 FOOTREST for 27702 - pair
- 27700 FOOTREST for 27703 - pair
- 27766 PLASTIC WC BOWL - spare - Ø 26xh 15 cm



GIMA code	Icon 1	Icon 2	Icon 3	Icon 4	Icon 5	Icon 6	Icon 7	Icon 8	Icon 9	Icon 10	Icon 11	Icon 12
27702/3	55	44	12.5	12.5	51	88	90	44	42	100	54x53x53	17 18
27701	56	44			47	94		43	38	100	50x19x75	8.5

WC - SHOWER COMMODO



- 27758 BATH BENCH with backrest
- Aluminium frame and padded seat. Removable plastic bowl WC.
- 27766 PLASTIC WC BOWL - spare

- 27759 WC - SHOWER COMMODO
- Suitable also as raised toilet seat
- Adjustable height 45-55 cm (back 78-88 cm)
- 27766 PLASTIC WC BOWL - spare

COMFORT COMMODO CHAIR



The generously padded and removable seat offers this chair the best comfort and high level of hygiene. Pan is removable from both sides and from the top.

- 43190 COMFORT COMMODO CHAIR - blue
 - 43191 COMFORT COMMODO CHAIR - height adjustable - blue
- Made in France.



MAX LOAD 130 kg

TECHNICAL SPECIFICATIONS	
Total height: 86 or 86/97 cm	Height seat-floor: 52 or 52/63 cm
Width between armrests: 51.5 cm	Height seat-backrest: 38 cm
Total width: 60.5 cm	Seat plate depth: 39 cm
Height armrest-floor: 72 or 72/83 cm	Total depth: 58 cm

□ LIGHTWEIGHT ALUMINIUM FOLDING WHEELCHAIRS



- 27708 PAEDIATRIC WHEELCHAIR - 35 cm seat - black tissue
- single cross bar
- padded flip-up armrest
- fixed footrest, flip-up foot plate with leg strap
- 15 cm (6") solid front castors
- 56 cm (22") pneumatic rear wheels
- locking brakes on rear wheels
- folding back
- large pocket on the back



- 43250 QUEEN ALUMINIUM WHEELCHAIR - 46 cm seat - light blue tissue
- double cross bar
- extra light aluminium frame only 9.5 kg
- fixed armrest, cloth pad
- fixed flip-up footrest with leg strap
- 15 cm (6") front solid castors
- 30 cm (12") pneumatic rear wheels
- folding back
- locking brakes on rear wheels



- 43251 PRINCE ALUMINIUM WHEELCHAIR - 46 cm seat - black tissue
- double cross bar
- fixed armrest, PU pad
- flip-up footrest with leg strap
- locking brakes for rear wheels
- 51 cm (20") PU rear wheels
- 15 cm (6") solid front castors
- folding back
- pocket on the back



- 43240 CLASSIC ALUMINIUM WHEELCHAIR - 46 cm seat - black tissue
- single cross bar
- padded flip-up armrest
- detachable footrest, flip-up plastic plate with leg strap
- 20 cm (8") solid front castors
- 61 cm (24") solid rear wheels with quick release axles
- folding back
- anti tipper system with 2 small wheels



- 27720 KING ALUMINIUM WHEELCHAIR - 46 cm seat - black tissue
- double cross bar
- flip-up and height-adjustable armrest, PU pad
- detachable footrest, flip-up plate with leg strap
- 61 cm (24") pneumatic rear wheels with quick release axles
- 15 cm (6") solid front castors
- anti tipper system with 2 small wheels and 2 carrying wheels



- 27717 DELUXE WHEELCHAIR - 46 cm seat - black tissue
- double cross bar
- flip-up height adjustable armrest, PU pad
- detachable footrest, flip-up plate with leg strap
- 61 cm (24") solid PU rear wheels
- 15 cm (6") solid front castors
- locking brakes on rear wheels
- anti tipper system with 2 small wheels

Wheel chair	SPARE - ACCESSORIES				Icons										DIM (mm)	NW (kg)	GW (kg)	
	Rear wheel	Front wheel	Foot-rest pair	IV stand	1	2	3	4	5	6	7	8	9	10				11
27708	27742	-	27710	27705	52	32	35	56	15	48	90	97	36	40	75	85x33x73	13	15
43250	43252	43253	43254	-	60	-	46	30	15	48	90	100	-	-	100	71x28x72	9.5	11
43251	43248	27789	43249	27705	63	-	46	51	15	48	91	-	-	-	100	84x31x74	11.8	13.5
43240	43244	43243	43242	-	68	30	46	61	20	50	96	106	42	46	120	81x30x80	15	17.5
27720	27787	27791	27728	27705	63	-	46	61	15	50	89	-	-	-	100	83x28x91	17.2	19.4
27717	27748	27791	27714	27705	67	36	46	61	15	51	91	105	40	45	100	80x33x93	17	19

FOLDING STEEL WHEELCHAIRS



ECONOMIC

CE

43220

- 43220 VALUE WHEELCHAIR - 46 cm seat - nylon black tissue
- double cross bar
- fixed armrest, PVC pad
- fixed footrest, flip-up plate, with leg strap
- 20 cm (8") solid front wheels
- 61 cm (24") solid rear wheels
- locking brakes on rear wheels
- pocket on the back



43220



CE

43225

- 43225 TRANSIT WHEELCHAIR - 46 cm seat - black tissue
- double cross bar
- fixed armrest, PVC pad
- fixed footrest, flip-up plate, with leg strap
- 15 cm (6") solid front wheels
- 30 cm (12") pneumatic rear wheels
- locking brakes on rear wheels
- handles brakes for rear wheels
- folding back
- pocket on the back



43225



MAX WIDTH 51 cm
FOLDED WIDTH 30 cm

Wheelchair passing through narrow transit areas

CE

43230

- 43230 NARROW WHEELCHAIR - 41 cm seat - black tissue
- single cross bar
- fixed armrest, PU pad
- detachable footrest, flip-up plate, with leg strap
- 20 cm (8") solid front wheels
- 52 cm (20") pneumatic rear wheels
- locking brakes on rear wheels
- adjustable distance from foot plate to front seat 46-56 cm
- pocket on the back



43230



CE

27709

- 27709 STANDARD WHEELCHAIR - 46 cm seat - blue tissue
- single cross bar
- chromed frame
- fixed armrest, PVC pad
- fixed footrest, flip-up plate with leg strap
- 20 cm (8") solid front castors
- 61 cm (24") solid rear wheels
- locking brakes on rear wheels
- large pocket on the back



27709



COMFORTABLE

CE

27715

- 27715 ROYAL WHEELCHAIR - 46 cm seat - black tissue
- double cross bar
- chromed steel frame
- flip-up armrest, PU pad
- detachable footrest, flip-up plate with leg strap
- 61 cm (24") pneumatic rear wheels with quick release system
- 15 cm (6") solid front castors
- locking brakes on rear wheels
- folding back
- large pocket on the back



27715



EXTRA LARGE - 56 cm

CE

27716

- 27716 EXTRA LARGE WHEELCHAIR - 56 cm seat - black tissue
- double cross bar
- powder coated steel frame
- super width 56 cm seat
- flip-up armrest, PU pad
- detachable footrest, flip-up plate with leg strap
- 20 cm (8") rubber foam front castors
- 61 cm (24") pneumatic rear wheels
- large pocket on the back



27716

Wheel chair	SPARE - ACCESSORIES						Icons for accessories										DIM	NW	GW			
	Rear wheel	Front wheel	Foot-rest pair	IV stand	Table*	PVC** backrest	1	2	3	4	5	6	7	8	9	10				11	12	
43220	43221	43222	43223	-	-	-	59	46	59	20	47	91							100	95x27x93	15	17
43225	43226	43227	43228	-	-	-	63	46	53	15	49	91							100	76x30x76	14	16.3
43230	43231	43232	43233	-	-	-	51	30	41		56	98.5	100	45	38			100	77x31x100	15.8		
27709	27744	27788	27711	27705	27706	-	64	24	46	58	20	49	87	106	40	45		100	94x23x89	17	19.2	
27715	27746	27789	27712	27705	-	27707	64	28	46	61	15	51	94	106	40	45		100	80x28x78	15.8	18.6	
27716	27747	-	27713	27705	27706	-	73	32	56	62	20	54	93	109	45	46		125	83x33x93	21.5	24.1	

** Fire retardant PVC backrest and seat

* Size of table: 32x55 cm

□ FOLDING WHEELCHAIRS



CE
Large pocket
on the back



Double cross braces
(only for codes 43262,
43272 and 43275)



- 43260 ESSEX WHEELCHAIR - 43 cm - black tissue
- 43261 ESSEX WHEELCHAIR - 46 cm - black tissue
- 43262 ESSEX WHEELCHAIR - 51 cm - black tissue
- blue powder coated steel frame
- rear solid PU wheels Ø 30.5 cm (12")
- front solid PU wheels Ø 20 cm (8")
- locking brakes on rear wheels
- front powder steel fork
- padded flip-up armrest
- detachable aluminium footrests with 6 height adjustable clips, flip-up plate, heel straps
- black nylon seat and back
- manual: GB, FR, IT, ES
- 43263 ALUMINIUM FOOTPLATE - pair - spare



CE
Large pocket
on the back



Quick release system

- 43270 OXFORD WHEELCHAIR - 43 cm - black tissue
- 43271 OXFORD WHEELCHAIR - 46 cm - black tissue
- 43272 OXFORD WHEELCHAIR - 51 cm - black tissue
- blue powder coated steel frame
- pneumatic rear wheels Ø 61 cm (24") with chromed steel handrim
- front powder steel fork
- padded flip-up armrests
- detachable footrests, flip-up plate, with leg straps
- black nylon seat and back
- manual: GB, FR, IT, ES
- 43274 OXFORD PLUS WHEELCHAIR - 46 cm - black tissue
- 43275 OXFORD PLUS WHEELCHAIR - 51 cm - black tissue
- Same as above, but with solid PU rear wheels Ø 61 cm (24") and anti tipper system.
- 43276 PLASTIC FOOTPLATE - pair - spare
- 43277 PNEUMATIC REAR WHEEL - spare for 43270-2
- 43278 SOLID PU REAR WHEEL - spare for 43274-5

Anti tipper
system for
43274-5



Wheelchair	1	2	3	4	5	6	7	8	9	10	11	12	13	14
43260	58	24	43	30.5	20	50	92	94	40	41	120	70x23x95	16	18
43261	61	24	46	30.5	20	50	92	94	40	41	120	70x23x95	16	18
43262	66	24	51	30.5	20	50	92	94	40	41	120	70x23x95	16	18
43270	60	26	43	61	20	50	92	102	40	41	120	82x26x85	18	20
43271, 43274	63	26	46	61	20	50	92	102	40	41	120	82x26x85	18	20
43272, 43275	68	26	51	61	20	50	92	102	40	41	120	82x26x85	18	20

□ POWERED WHEELCHAIR

- 27729 POWERED WHEELCHAIR - 41 cm seat
- Powered wheelchair, easy to use, for daily indoor use. The user can move the powered wheelchair forwards, backwards or turn round in the same place only by the controller. When the power is not enough, it can be used as a transit wheelchair. The seat cushion is detachable. Powder coated steel frame, adjustable armrest pad, detachable sideboards, detachable strong footrests, adjustable backrest inclination, rubber foam castors and drive wheels, with safety lamp. Size: 1,090x630x970 mm, weight: 64 kg (including batteries). Load: 110 kg. Speed: 0-6 km/h. Power: 2x12 V=24 V (20 km distance with fully charged batteries) Battery charger 100-240 V, 50/60 Hz included.
- 27725 SLA BATTERY pack of 2 - SPARE

Pivoting up to: 12°



ANTI-DECUBITUS AIR MATTRESSES WITH PUMP - STAGE I AND II



BUBBLE MATTRESS
Designed for the treatment and prevention of pressure sore stage I in short-term and domiciliary therapies. The PVC mattress is composed of 130 7 cm-high bubble cells, particularly comfortable. Fixable to bed by extra flaps on both top and bottom side. Cold-resistant -30 degrees.

PUMP SYSTEM
Special silent pump for an excellent pressure regulation by a knob on the front panel. It can be hung to any kind of hospital bed frame by means of two adjustable hooks. For use with bubble or alternating cell mattresses.



TECHNICAL SPECIFICATIONS - PUMP

	28565	28568
Size:	25x12xh 10 cm	
Operating voltage:	220 V, 50 Hz	
Working pressure:	40-100 mmHg	40-110 mmHg
Air output:	6-7 liter/min	6-7 liter/min
Cycle time:	6 min	12 min
Plastic casing:	Taiwan chimei ABS	
	-TUV-CE IEC/EN60601-1; 60601-1-2-	



INTERCHANGEABLE CELL-MATTRESS
Recommended for the prevention and treatment of pressure sore stage I and II in medium-term and domiciliary therapies. The 20 9.5 cm-high Nylon+PVC cells provide superior comfort.

code	MATTRESSES AND PUMP
28564	Bubble mattress
28565	Pump for 28564
28566	Kit bubble mattress+pump (28564+28565)
28567	Interchangeable cell mattress
28568	Pump for 28567
28569	Kit cell mattress+pump (28567+28568)
28570	Spare cell for 28567

Manual and box in 10 languages: GB, FR, IT, ES, DE, PT, PL, HU, GR, Arabic

TECHNICAL SPECIFICATIONS - MATTRESS

	28564	28567
Total size:	200x90x7 cm	200x86x9.5 cm
Cell height:	7 cm (2.7")	9.5 cm (4")
Material:	PVC	Nylon+PVC
Thickness:	0.32 mm	0.32 mm
Number of cells:	130	20+1 spare
Suitable for persons up to:	135 kg	140 kg

THERAPEUTIC ANTI-DECUBITUS MATTRESSES - STAGE III AND IV



• **28575 KIT 5010 ALTERNATING PRESSURE MATTRESS + PUMP**
Valuable overlay system designed for prevention and treatment of patients at moderate to intensive risk of pressure ulcers. Pressure is periodically redistributed by inflating and deflating cells in order to mimic natural sleep movement patterns and avoid long term pressurization of tissue. Manual in: GB, IT.

• **28576 CELL for 28575 - spare**

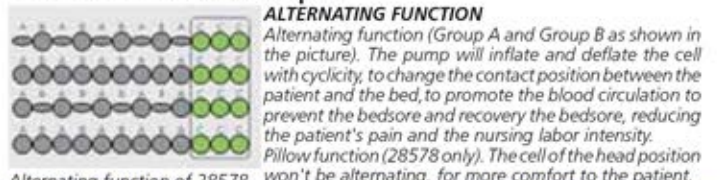

Alternating function of 28578

TECHNICAL SPECIFICATIONS - PUMPS (28575 and 28578)

Size:	30x13.5xh 11 cm	Cell height:	12.5 cm (5")
Operating voltage:	220 V, 50 Hz	Working pressure:	55-120 mmHg
Cycle time:	12 min	Air output:	7-8 liter/min
Case material:	Flame retardant ABS		
	TUV-CE IEC/EN60601-1; 60601-1-2		

PUMP 28578 only
Static Mode, low pressure alarm, quick connector, transfer function



• **28578 KIT 8050 ALTERNATING PRESSURE MATTRESS + PUMP**
Advanced systems of alternating pressure mattress. The multi-mode pump offers:
- **alternating mode:** the pressure is periodically redistributed by inflating and deflating cells in order to mimic natural sleep movement patterns and avoid long term pressurization of tissue.
- **constant static mode:** the pressure is about 2/3 lowered when compared to the same pressure level from alternating mode by means of immersion and envelopment. Visual alarms notify the caregiver unusual situation, reducing the risk of human error. Suitable for the prevention and treatment of all stages of pressure ulcers. Manual in: GB, IT.

• **28579 CELL for 28578 - spare**

TECHNICAL SPECIFICATIONS - MATTRESS

	28575	28578
Total size:	200x90x12.8 cm	200x90x22 cm
Alternating:	1 in 2 (group A and B)	
Cell height:	12.8 cm (5")	22 cm (8.66")
Cover material:	Nylon PU with button	Nylon+PU with cotton lining
Thickness:	0.4 mm	0.3 mm
Cells material:	nylon PVC	TPU
Suitable for persons up to:	150 kg	180 kg

ANTI-DECUBITUS AIR MATTRESSES - MADE IN ITALY

• 28483 KIT MASTER (AIR MATTRESS 28492 + MASTER PUMP 28482)

• 28492 AIR MATTRESS WITH BUBBLES

Air mattress with bubble sections which inflate and deflate alternatively latitudinally through the alternative compressor. The continual movement given by the pressure pumped inside is useful to prevent minor bedsores problems.

TECHNICAL SPECIFICATIONS MATTRESS - 28492

Total size: 190x85 cm
Inflatable size: 160x85 cm
Weight: 3 kg
PVC thickness: 0.4 mm
Suitable for persons up to: 90 kg



28492

• 28495 RINT PLUS AIR MATTRESS - interchangeable cells
Rint Plus Mattress is made of a strong and soft PVC, realized with 17 big interchangeable bars. The integrated CPR function (Cardio Pulmonary Reanimation) allows the immediate emptying of the 17 bars. Supplied with bi-elastic, liquid proof and permeable to water-steam cover.

• 28496 INTERCHANGEABLE CELL - spare for 28495

• 28497 COVER - spare for 28495

TECHNICAL SPECIFICATIONS MATTRESS - 28495

Total size: 195x85x10.5 cm
Inflatable size: 170x90 cm
Weight: 5.5 kg
PVC thickness: 0.4 mm
Number of elements: 17
Suitable for persons up to: 120 kg



28498

Thanks to height of cells, Rint Plus can be used also with medium risk patients.

• 28482 MASTER PUMP SYSTEM - with pressure adjustment

Made of stiff and strong ABS with control handle for easy pressure regulation. Air amount is adjustable to suit patient weight from 40 to 90 kg (28492) or 120 kg (28495). The mattress should inflate totally in about 20 minutes. Air output 2.5 l/min. Master pump can be used with bubble or interchangeable section mattress. Flame retardant PVC.

• 28481 MEMBRANE - spare for pump 28482/3

TECHNICAL SPECIFICATIONS FOR MASTER PUMP - RINT PLUS PUMP

Size: 315x150x120 mm
Weight: 1.95 Kg
Operating voltage: 230 V - 50 Hz
on request 110 V - 60 Hz
Power Consumption: 8 W
Working pressure: 30-120 mm/Hg
Regulations: IEC-601-1 class II Type B CLASS II



Master pressure pump may be placed on the ground as it has rubber feet or hung at the edge of the bed.

CE

28482

Low noise, long lasting pump made with high quality materials



User manual in: GB, FR, IT, ES, DE

• 28498 RINT PLUS PUMP SYSTEM - with pressure adjustment
Same as Master pump (28482) but with special valve for use with Rint Plus Mattress.

• 28481 MEMBRANE - spare for 28498

ANTI-DECUBITUS PVC WATER MATTRESS

• 28499 WATER MATTRESS

It is made in PVC with a stabilising inflatable external structure to prevent excessive water "wave motion" and of 3 independent units.

The water mattress distributes the total pressure on the whole supporting surface, making this less than the average arterial pressure, avoiding the exposure of the skin to pressure risk.

Easy to use, it is placed over the usual mattress and it is washable. It is sold with a manual pump, 2 disinfectants and an inflation tube.

Size: 190x85 cm.

Weight 4 kg.

PVC thickness 0.4 mm

MADE IN ITALY



28499

Each water section measures 60x70 cm

PVC rigid edge inflatable with air

PVC WATER MATTRESS

• 28502 VALUE PVC WATER MATTRESS

It helps movement and distributes pressure on the whole supporting surface.

Double sealed seams provide maximum strength and durability.

Highly resistant PVC material construction easy to clean with any mild detergent.

Air frame + 3 water elements.

Supplied with hand pump and hose.



28502

TECHNICAL SPECIFICATIONS

Material: PVC 0.40 mm thickness
Size of outer air frame: 200x93x11.5 cm
Size of each element: 69x60x11.5 cm
Weight: 3.5 kg

SHAMPOO BASIN

• 28507 SHAMPOO BASIN
Inflatable shampoo basin ideal for personal in-bed hair care needs. It supports the head, neck and shoulders during shampooing.

A 20 cm deep basin helps prevent splashing. Drain hose efficiently removes water and foam. Supplied with water bag with shower head in clip.

Size: 53x61x20 cm
Capacity: 10 l
• 28509 WATER BAG - spare



28509

Water bag for easy water transport when water source is not easily accessible

28507

ANTI-DECUBITUS CUSHIONS - MADE IN FRANCE

28530 **28534** **28538**

Visco elastic foam Visco elastic gel

PREVENTION FOR LOW TO MEDIUM DECUBITUS RISK **PREVENTION FOR HIGH DECUBITUS RISK** **PREVENTION FOR HIGH TO VERY HIGH DECUBITUS RISK**

GIMA line of seat cushions is designed to prevent decubitus risk for patients on wheelchair or permanently on chairs. All cushions in Gel or Foam are supplied with a waterproof PU cover with zipper and handle.

- **28530 BULGEL CUSHION 41x41x3 cm**
- **28531 BULGEL CUSHION 43x43x3 cm**

This anti-decubitus cushion is made of a flame-resistant pocket including a PE foam core covered by an aqueous gel.

- **28534 VISCO-MOUSS CUSHION 41x41x6 cm**
- **28535 VISCO-MOUSS CUSHION 43x43x6 cm**

Pre-shaped moulded cushion made of viscoelastic foam with memory effect. Memory foam is pressure sensitive and moulds quickly to the shape of a body pressing against it, returning to its original shape once the pressure is removed. Anatomical shape with raised lateral edges and front-back slope improves positioning, stability and comfort when seated. Foam density: 86 kg/m³

- **28538 GEL AIR 2D CUSHION 41x41x7.5 cm**
- **28539 GEL AIR 2D CUSHION 43x43x7.5 cm**

Made of a contoured moulded viscoelastic foam base (i.e. Visco Mouss) connected to a polyurethane gel insert. The viscoelastic fluid gel (blue pad) ensures maximum pressure relief of vulnerable bony areas while the regular gel and the foam increase the contact surface and maximize pressure relief. The cushion's shape ensures a good posture while seating and prevents from sliding forward. Foam density: 86 kg/m³

AIR CUSHIONS

- **28544 GIMA AIR CUSHION - 40x40x6 cm**
 - **28546 GIMA AIR CUSHION - 45x45x6 cm**
- with polyester cover, pump and repair kit - single compartment
- air cells, 64 or 81, prevent pressure sores
 - maximizes pressure distribution and blood flow
 - conforms to the body's shape
 - adjust to body changes over time.
- Max load: 150 kg
Multilanguage manual: GB, FR, IT, ES, PT, GR, PL, DE



HEEL PROTECTOR

- **28548 HEEL PROTECTOR - 50x22x16 cm**
- It relieves the heel pressure and prevents decubitus ulcer by increasing the contact surface. The visco elastic foam has an anatomical shape including a bactericide and fungicide agent to provide better hygiene and disinfection.
- Made in France
Density: 90 kg/m³



ANTI-DECUBITUS CUSHIONS AND NECK PILLOWS - MADE IN ITALY

Products to prevent low decubitus risk, made of silicone fibre, coated with 100% preshrunk cotton cover. Main property of

silicone fibre is to maintain original shape also after strong pressure. This allows to maintain comfort and proper weight

distribution in the time. Breathable cotton cover provides maximum cool comfort. Washable at 30-40°C.



• **28550 SHAPED CUSHION WITH HOLE**



• **28551 3-SECTION CUSHION**



• **28552 CUSHION WITH CONCAVE CENTRE**

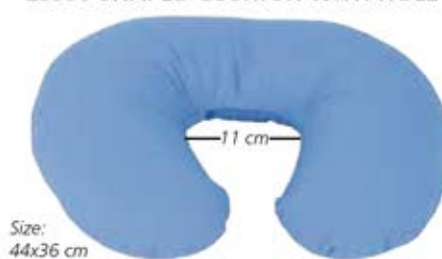

• **28555 TRAVEL NECK PILLOW**



• **28556 HEEL CUSHION**



• **28557 HEEL CUSHION PLUS**

RELAXING ARMCHAIR WITH 1 OR 2 ENGINES - MADE IN ITALY



45150
or 45155

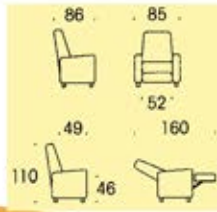

10 COLOURS
AVAILABLE

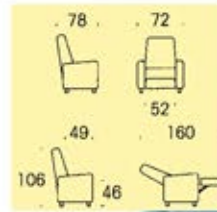

45161
or 45166

RELAXING ARMCHAIRS

Relaxing multifunctional armchair adaptable to any need. 2 models (Beatrice and Betty), 1 or 2 engines and 10 colours. Fabric 100% polyester. Load 120 kg. **One engine:** two button control for synchronized movement of leg section and back.

Two engines: four button control for independent movement of leg section and back. Lift motor 230 V - 50 Hz.

1 engine + lifting up



2 engines + lifting up



1 engine	2 engine	BEATRICE ARMCHAIRS
45150	45155	Beatrice - colour on request**
45151	45156	Beatrice - beige 2

**Product available in 15-20 days

1 engine	2 engine	BEATRICE ARMCHAIRS
45160	45165	Betty - colour on request**
45161	45166	Betty - blue 11

INVALID RINGS



28611

Quality invalid rings made of latex-free rubber. Internal hole Ø 14 cm.



28614

GIMA code	INVALID RUBBER RINGS LATEX - FREE
28610	Invalid ring Ø 35 cm
28611	Invalid ring Ø 40 cm
28612	Invalid ring Ø 45 cm
28614	Pump for invalid ring

BED-TRAYS - FOLDING LEGS

Bed-trays with anti-scratch surface and containing edge. Folding legs. Size: 60x40x24 cm. Made in Italy.

- 44750 BED TRAY - white
- 44753 SERVOPLUS BED TRAY - 3 position - walnut



44750

Weight: 2.75 kg



44753

Weight: 3.2 kg
Bed tray/bookrest tilting in 3 positions.

DINING TABLE



27449

• **27449 DINING TABLE**
Patient dining table with polished aluminium tubular structure. White laminated wooden top, easy to clean, with anti-shock rubber PVC band. It is mounted on two rubber feet and two plastic wheels Ø 40 mm to allow movability and comfortable use. Delivered in kit form. Made in Italy.

OVERBED TABLES



27458

Adjustable height:
76 to 113 cm

Size: 70x44xh 76/113 cm



Adjustable height:
72 to 110 cm

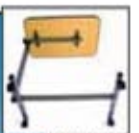

Set into the panel



Lock and adjustable panel



Adjustable height

• **27458 OVERBED TABLE - moulded shelf**
Chrome plated/epoxy glass finish square steel tube. Tilttable and sliding serving tray made of thermoformed anti-shock plastic material with retaining edges and pre-formed bottle, glass and cutlery holder. Base with 4 Ø 50 mm castors (2 with brake). Delivered in kit form. Made in Italy.

• **27448 OVERBED TABLE**
Overbed table with steel frame and high density board. Base with 4 Ø 50 mm (2.5") removable castors (2 with brake). Adjustable height and angle. Board size: 41x61 cm. Carton size: 65x7x67 cm. Delivered in kit form.

HYDRAULIC AND ELECTRICAL LIFTERS



• **27749 HYDRAULIC LIFTER** - max load 200 kg
Lifting movement through a hydraulic pump operated by adjustable side control lever. Descent movement by independent exhaust-valve. Adjustable base 68 to 118 cm controlled by a manual device for an easy access to narrow places. Painted steel frame. Anti trauma push-handle. 2 rear castors Ø 100 mm, with independent brake and 2 front castors Ø 70 mm. Equipped with sling with head support (27754). Made in Italy.

• **27752 ELECTRICAL LIFTER 170** - max load 170 kg
• **27753 ELECTRICAL LIFTER 200** - max load 200 kg
Same as code 27749 but with electrical controls. Up and down movements through an electric motor 24V D.C. and push button. Battery fed with current transformer with an emergency push-button for the immediate stop of the movement and free up/down piston-stroke. Supplied with universal sling (27752) or sling with head support (27753).
• **27757 UNIVERSAL SLING** - spare - load 170 kg
• **27754 SLING with head support** - spare - load 250 kg
Mesh fabric sling.



LIFTING STAND



• **27645 LIFTING STAND**
Tubular painted steel frame with adjustable chromed steel joint. Can be fully disassembled to reduce size. Three main height adjustments. Triangle hangs from belt with adjustable length.

SHOWER MATTRESS

• 27836 SHOWER MATTRESS

It allows bed-ridden, elderly or disabled patients to be washed and cared for in their personal hygiene with running water directly on their bed, without any need for transfer/lift. Inside the "Shower Mattress", the patient can be showered with water coming from the tap via an extension hose or using the special pressurized water tank provided with flexible hose and shower head.

Once finished, the water is drained into a suitable container. Complete with plug and flexible hose for quick water drain.

• 27837 WATER TANK - 10 l

Pressurized water tank complete with flexible hose 4 m and shower head operated by button.

• 27838 SHOWER EXTENSION HOSE

Flexible, 6 m hose complete with button-operated shower head and tap adapter.



SHOWER TROLLEY - HYDRAULIC OR ELECTRIC HEIGHT ADJUSTMENT

• 44770 SHOWER TROLLEY - hydraulic

Shower stretcher can be used for both transport and showering, and is the ideal solution for treatment of patients in assisted baths of hospitalization or retirement home.

Easy to move thanks to rubber castors with individual brake and one with directional lock to facilitate transport in long linear path.

Automatic progressive tilting to allow a gradual water drainage.

Safety side rails with one-hand folding/locking system. Supplied with PCM foam padded waterproof mattress made with fire-resistant auto-extinguishing Class 2 PVC, trapezoidal pillow, same specifications as mattress, and extendable and flexible drain hose (Ø 40 mm - length 1.5 m).

• 44771 SHOWER TROLLEY - electric

Same as 44770 but with electric lifting system (Linak actuator, 6,000N, DC 24 V, 4.5 A).

IP x 5 control box with emergency stop.

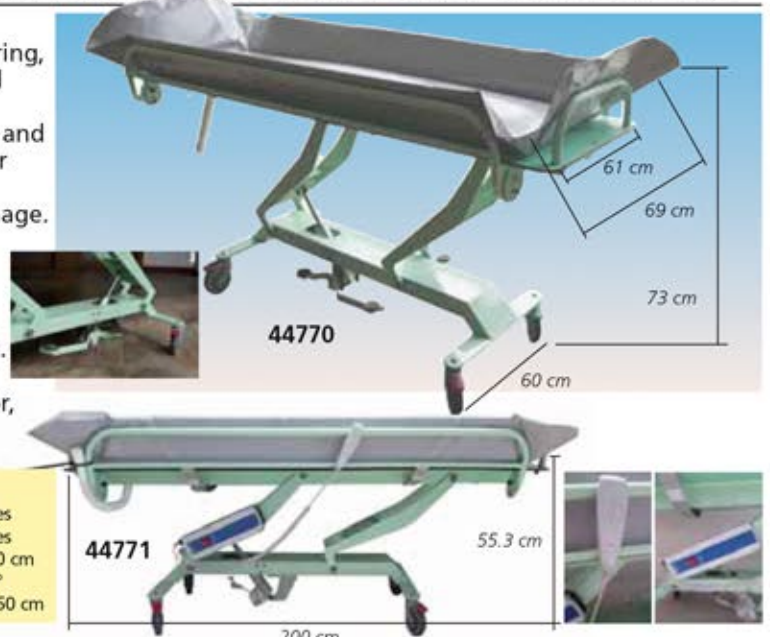

TECHNICAL SPECIFICATIONS

Max working load:	190 kg	Directional system:	yes
Weight:	93 kg	Collapsible head end rail:	yes
Size:	2,000 x 746 x h 753/1,108 mm	Mattress height:	20 cm
Castor diameter:	12.5 cm	Tilt for water discharge:	7°
Castor braking system:	Individual on each castor	Discharge hose length:	150 cm

MATTRESSES, COVERS AND PILLOWS

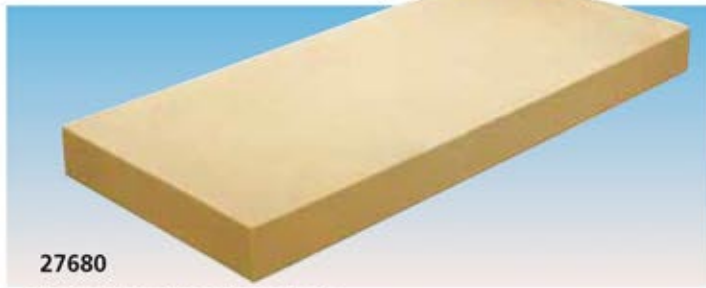

27680

- 27690 MATTRESS 190x80x12 cm
 - 27680 MATTRESS 195x85x14 cm
- Polyurethane foam mattresses, density 30 kg/mc
- 27693 100% COTTON COVER FOR MATTRESS 27690

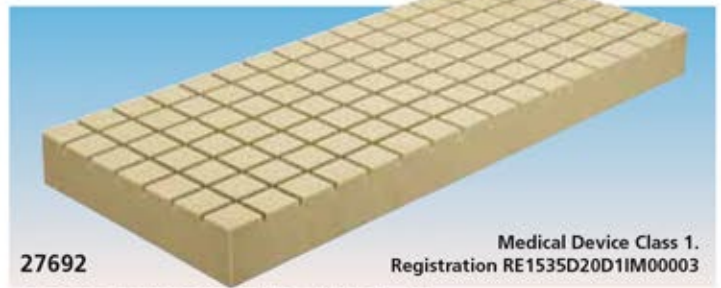

27692

Medical Device Class 1.
Registration RE1535D20D1IM00003

- 27692 DAMA MATTRESS 195x85x14 cm
- Expanded polyurethane mattress, density 30 kg/mc. Fire proof and latex free. Antibacterial, hypoallergenic and antifungal. Autoclavable at 135 °C.

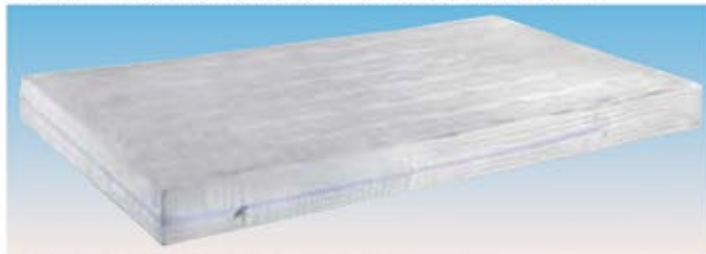

- 27682 MATTRESS WITH COVER 195x85x14 cm
- Polyurethane foam mattress, density 30 kg/mc with flame retardant, 100% breathable polyester cover. Class 1



Medical Device Class 1IM.
Registration RE1535D20D1IM00008

- 44804 HNF MATTRESS WITH COVER 195x85x14 cm
- Polyurethane foam mattress, density 35 kg/mc. Non deformable, antibacterial, antifungal and autoclavable at 135°C. Supplied with TEKMA polyurethane cover with zip fastener.

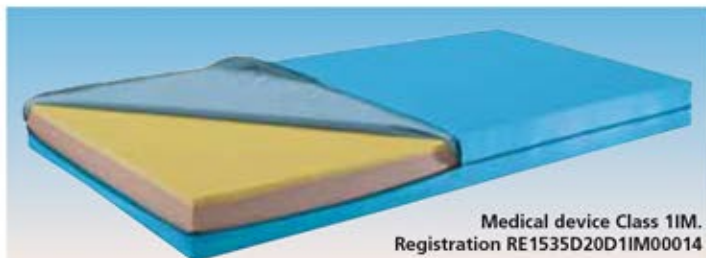

Medical device Class 1IM.
Registration RE1535D20D1IM00014

- 44806 AMYLIFE MATTRESS WITH COVER 195x85x14 cm
- Mattress with polyurethane foam base and viscoelastic high density top. Density 35 kg/mc (base), 60 kg/mc (top). Non deformable, antibacterial, antifungal and autoclavable. Supplied with TEKMA polyurethane cover with zip fastener.

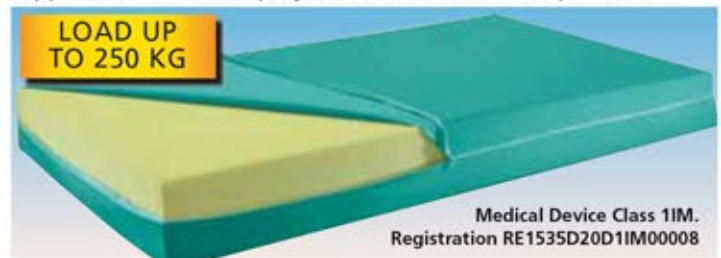

Medical Device Class 1IM.
Registration RE1535D20D1IM00008

- 44803 MATTRESS WITH COVER 195x85x18 cm
- Polyurethane foam mattress, density 35 kg/mc. Non deformable, antibacterial, antifungal and autoclavable at 135°C. Supplied with TEKMA polyurethane cover with zip fastener.



Class 1IM.
Registration
RE1535D20D1IM00001

- 27696 PILLOW 45x75x10 cm
- Polyurethane foam, transpirant, pillow, density 21 kg/mc with polyester, fire retardant, cover. Washable at 95°C, autoclavable.



Class 1IM.
Registration
VA735D1IM00014

- 44812 SWEET DREAM PILLOW 50x80x18 cm
- Polyester padding and polyester cover washable at 40°C. Fire retardant.



Class 1

- 27681 POLYESTER COVER 195x85x14 cm - white
- Transpirant polyester fireproof cover for mattresses (27680, 27682, 27692)



Class 1

- 27695 TEKMA POLYURETHANE COVER - 195x85x18 cm - white
- Soft, fire retardant, transpirant and waterproof cover. Universal (up to h14 cm) with elastic. Washable. Autoclavable at 134°C.

BACKREST



- 44825 BACKREST - blue
- Painted steel tubular frame. Adjustable in 5 positions .

COVER LIFTER

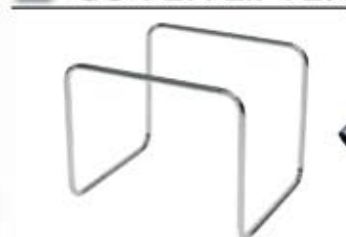

- 27642 COVER LIFTER
- Chromed steel tubular frame. Can be disassembled.

A4 AND A3 RECORD HOLDERS



- 27647 A4 INOX RECORD HOLDER 37x25x5 cm
- 44820 A4 PVC WHITE RECORD HOLDER 24x32 cm
- 44821 A3 PVC WHITE RECORD HOLDER 43x32 cm

Universal hook to fit any bed frame

Privacy system: non visible patient file

0.700 kg

27647

44820

44821

HOSPITAL BEDS



27841 Height adjustable 160 to 245 cm



27610 + accessories

Lifting pole Code 27644 (not included)

Collapsible support code 27641 (not included)



27646

BED WITH ADJUSTABLE HEAD SECTION

- 27600 BED WITH 1 ARTICULATION
- 27601 BED WITH 1 ARTICULATION - with wheels

Painted steel frame with net.
 1 Pipe frame with net for head movement, 200x85 cm.
 2 Heads in chromed pipe complete with MDF bilaminated coated panel. Movement by a crank. Protection of end run. Rubber wheels of Ø 100 mm, with brakes (only for code 27601)
 Size: 206x89xh 90 cm. Height of frame from bottom 52/55 cm.
 Size of frame: 200x85 cm. Weight 32 kg.
 Made in Italy

BED WITH ADJUSTABLE HEAD AND FOOT SECTION

- 27610 BED WITH 3 ARTICULATIONS
- 27611 BED WITH 3 ARTICULATIONS - with wheels

Painted steel frame with net.
 3 bed frames with nets in painted steel pipe, 200x85 cm.
 2 Heads in chromed pipe complete with MDF bilaminated coated panel. Movement by 2 cranks. Protection of end run. Rubber wheels of Ø 100 mm, two of which with brake (only 27611)
 Size 206x89xh 90 cm. Height of frame from bottom 52/55 cm.
 Size of frame: 200x85 cm.
 Weight 42 kg. Made in Italy



27605



27608

- 27605 STANDARD BED - no castors
 - 27606 STANDARD BED - Ø 50 mm castors
 - 27607 STANDARD PLUS BED - no castors
 - 27608 STANDARD PLUS BED - Ø 100 mm castors
- Simple bed made of epoxy - coated steel. Head and foot ends with plastic feet. Rigid mesh mattress platform.
- 27607 STANDARD PLUS BED - no castors
 - 27608 STANDARD PLUS BED - Ø 100 mm castors
- Chrome-plated steel bed ends. Laminated plastic panels. Rigid mesh mattress platform. Adjustable back-rest
 Size: 206x89xh 90 cm. Made in Italy.
- 27841 I.V. STAND - 5 wheels trolley

code	ACCESSORIES FOR ALL BEDS
27641	Collapsible supports (for all types of bed)
27644	Lifting pole
27646	4 Hook IV stand for bed - stainless steel

BEDSIDE TABLES - MADE IN ITALY



27665

Size: 42x40xh 83 cm



27669

Size: 42x40xh 83 cm



27674

Size: 42x40xh 80 cm



27662

Size: 42x52.5xh 80 cm



27679

Four revolving castors Ø 60 mm (2 with brake) with bumpers Ø 100 mm.



27678

DOUBLE FACE

BEDSIDE TABLES

Epoxy powder coated steel sheet tube or body.
 Thermoformed ABS top and drawer. Laminated plastic drawer face and door (27665 and 27666 only) 10 mm thick. Bedside table with door has inner removable shelf and is available in left (L) or right (R) version.

- 27669 BEDSIDE TABLE WITH DRAWER
- 27665 BEDSIDE TABLE WITH DRAWER AND LEFT DOOR
- 27666 BEDSIDE TABLE WITH DRAWER AND RIGHT DOOR

FEBO BEDSIDE TABLES

Epoxy powder coated steel sheet 8/10 body. Towel holder and lateral bottle holder (27662 only). Soft rubber antitrauma handle. Sliding drawer with removable ABS tray. Inner removable shelf. 4 revolving castors (2 with brake)

- 27674 FEBO BEDSIDE TABLE - blue avio RAL 5014
- 27675 FEBO BEDSIDE TABLE - other colours*

RAL 5010	RAL 2003	RAL 6019	RAL 1013	RAL 7040
----------	----------	----------	----------	----------

*Available in 30 days. Minimum order 10 pcs.

- 27662 FEBO BEDSIDE TABLE WITH BOTTLE HOLDER - blue avio RAL 5014

BEDSIDE TABLE WITH DRAWER, DOOR, BOTTLE - GLASS HOLDER, OVERBED TABLE

Epoxy powder coated steel sheet body. Thermoformed ABS top with towel holder, lateral bottle and glass holder. Sliding drawer with removable ABS tray. Laminated plastic drawer face and door 10 mm thick. Anti-trauma handles. Revolving, extensible, adjustable height cm 90/110 ABS overbed table top. Removable inner shelf. Plastic grid at bottom.

- 27678 BEDSIDE TABLE - DOUBLE FACE
- 27679 BEDSIDE TABLE - SINGLE FACE

PATIENT BEDS WITH 1 OR 3 JOINTS, MANUAL OR ELECTRIC

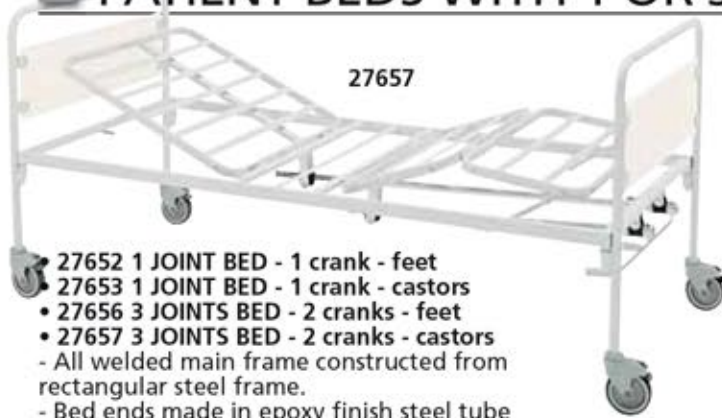

27657

- 27652 1 JOINT BED - 1 crank - feet
- 27653 1 JOINT BED - 1 crank - castors
- 27656 3 JOINTS BED - 2 cranks - feet
- 27657 3 JOINTS BED - 2 cranks - castors
- All welded main frame constructed from rectangular steel frame.
- Bed ends made in epoxy finish steel tube
- 1 joint/2 sections or 3 joints/4 sections
- manual movement by 1 or 2 cranks with retractable handles
- legs fitted with 4 revolving directional rubber/steel castors with independent brake or plastic feet.



27660

- 27658 3 JOINTS BED - 2 cranks - variable height - castors
- 27659 3 JOINTS BED - electric - castors
- 27660 3 JOINTS BED - electric - variable height - castors
- 3 joints/4 sections beds adjustable by means of 2 independent cranks (27658) or electric motor 24 V DC and push button
- height adjustable by hydraulic foot pump (27658) or electric motor (27659/60)
- Legs and other features as 27652

TECHNICAL SPECIFICATIONS

	27652/3	27656/7	27658	27659	27660
Size of platform:	900x2,000 mm				
Platform height mm:	475	475	400/800	475	400/800
Height of bed ends mm:	950				
External measurement:	910x2,060 mm				
Packing size mm:	960x145x2,070		960x220x2,070		
Movement:	1 crank	2 cranks	2 cranks	electric	electric
Max patient load kg:	135				

ACCESSORIES FOR PATIENTS BEDS

GIMA code	ACCESSORIES FOR PATIENTS BEDS
27663	Collapsible support - couple
27667	Infusion pole with universal clamp
27668	Lifting pole with slot in system
27661	Kit for castors spare for 27658/59/60



27652

27659



27663
Collapsible support



27668 27667
Infusion pole and lifting pole

SPECIALISTIC BED 3-JOINTS/4 SECTIONS, ELECTRICAL, ADJUST. HEIGHT



Height adjustment of platform from ground from 40 to 80 cm (27673) or 23 to 63 cm (27672)

Possibility of Trendelenburg (12°) and reverse-Trendelenburg (12°) movements



27673

- 27673 SPECIALISTIC BED with Trendelenburg - 40-80 cm
 - 27672 SPECIALISTIC LOW BED with Trendelenburg - 23-63 cm
- Three-joints, four sections bed with adjustable height from 40 to 80 cm or 23-63 cm with full electrical movements.
- All welded mainframe made of rectangular steel tube 50x25x2 mm. Mattress platform with flexible wooden staves, complete with mattress-hold guides. Backrest-section and leg-section adjustable by means of two independent electric motors 24V D.C. and push-button. Foot-section adjustable by means of a rack device. Fixed pelvis-section. Removable head and foot-end frames made of natural beech finish wood with solid corners and edges.
- Comes complete with 2 vertical sliding bars with upper/lower lock/unlock keys and lifting pole.
- Legs fitted with 4 castors Ø 100 mm with independent brake.

TECHNICAL SPECIFICATIONS

Size of platform:	900x2,000 mm
Platform height:	400-800 mm (27673) 230-630 mm (27672)
External measurement:	1,030x2,140 mm
Height of bed end from mattress platform:	50 mm
Max load:	135 kg
Weight:	102 kg
Operating power:	230 V - 50 Hz



QUALITY
EN 1970:2000
DIN EN 1970:2000-12
EN 60601-2-38:2001
DIN EN 60601-2-52:2009



27672

- 27676 WOODEN BEDSIDE TABLE - height adjustable, tiltable tray
Manufactured by quality laminated wooden panel. Particularly functional: with drawer, 2 doors (can be used from both sides) and lateral height adjustable (73-100 cm) tiltable tray at 90° (27676) or swing type tray (27677).
- 27677 WOODEN BEDSIDE TABLE - extractable tray



27676



27677

I.V. STANDS

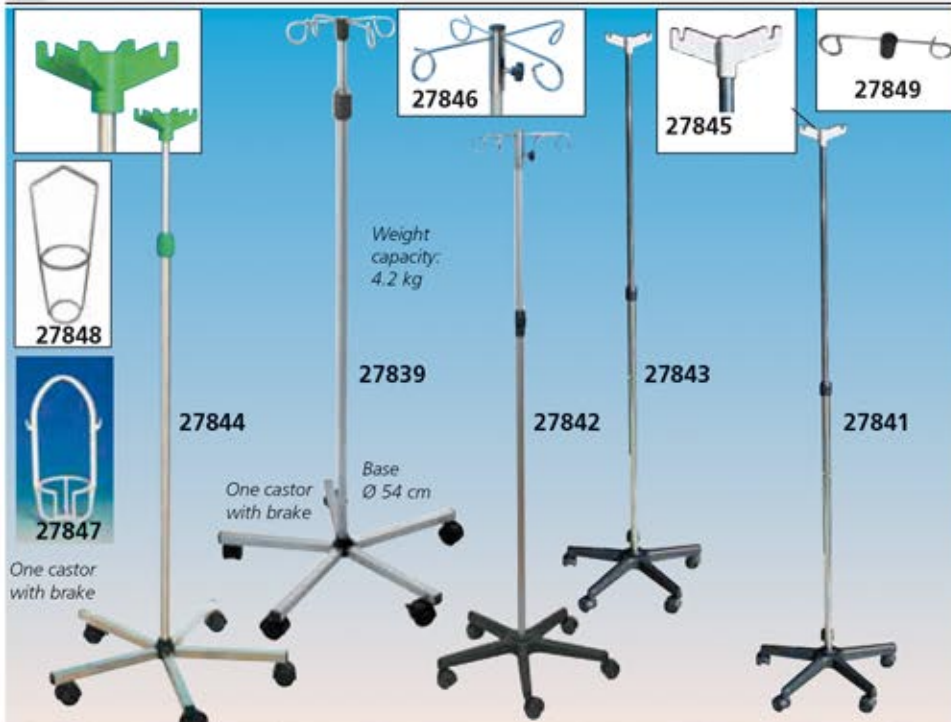

GIMA code	N	Hook Material	Stand Material	Adjustable height	Base Material	Weight kg
27839	4	Stainless steel	Stainless steel AISI 304	160-220 cm	Stainless steel	3.3
27841*	2	plastic	Chromed-steel	160-245 cm	plastic	2.9
27842*	4	metal	Chromed-steel	160-245 cm	plastic	3.2
27843*	2	plastic	Aluminium	158-248 cm	plastic	2.9
27844	4	plastic	Stainless steel AISI 304	160-220 cm	Stainless steel	2.9
27845	2	plastic	Plastic support for bottle holder - load 1 kg each hook			
27846	4	metal	Metal support for bottle holder - load 1 kg each hook			
27849	2	Stainless steel	Stainless steel AISI 304 support for bottles holder			
27847	-		Plastic bottle holder - box of 40 pcs.			
27848			Stainless steel AISI 304 bottle holder. Capacity 2.5 kg			

*Maximum load 2 kg each hook

HYPODERMOCLYSIS STAND



- **27856 HYPODERMOCLYSIS STAND** Stand with hydraulic height adjustment for hypodermoclysis, for washing and surgical irrigation. Hydraulic pump with pedal for height adjustment and gripping handle for easy transport. Made in Italy.

SWADDLING TABLE

- **27400 SWADDLING TABLE** - beige Baby changing table with Itallumag tubular frame with 2 shelves. Padded worktop 115x60 cm in soft washable fireproof (Class 1 IM) simulated leather and lower shelf 100x40 cm, in laminated chipboard panel. Max load: 60 kg. Size: 115x63xh 85 cm. Weight: 28 kg. Delivered disassembled. Made in Italy.



27400

NEONATAL CRADLE

- **43500 NEONATAL CRADLE** with trolley Transparent unbreakable plastic cradle with round edges and ventilation holes. Epoxy powder painted mainframe made of curved and welded tubular steel. Shape of trolley allows horizontal and Trendelenburg inclinations and bedside positioning. Legs fitted with 4 synthetic rubber castors Ø 75 mm, two with brake. Dimensions: 83.5x52.5xh 90 cm. Weight: 15 kg. Max load: 10 kg. Delivered disassembled. Made in Italy.
- **43501 CRADLE** - spare
- **27685 MATTRESS** 63x37x5.5 cm - fireproof
- **27686 COVER** - water proof

Manual: GB, FR, IT, ES



43500

PEDIATRIC BED

- **27399 PAEDIATRIC BED** 1-4 years 200°C epoxy powder painted mainframe made of steel tube Ø 30 mm, ready to be hooked into the mattress platform. Mesh mattress platform made of oval tube 40x20 mm, fixed to the mainframe with removable bolts. Side rails 62 cm h. sliding on chromed steel guides, with safety device. Legs with 4 castors Ø 80 mm, two with brake. Weight 35 kg. External measurement 140x70xh 130 cm. Inner size 130x65xh 63 cm. Made in Italy.



27399

Colour: ivory (RAL 1013)

- **27687 MATTRESS** 125x62x10 cm - fireproof
- **27688 COVER** - water proof

AN INTEGRATED SYSTEM OF TREVIRA® CURTAINS

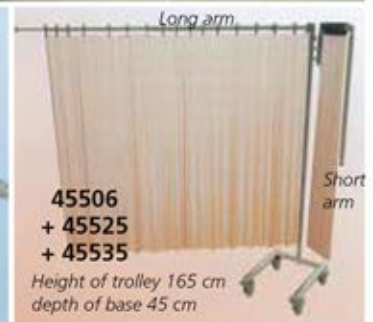
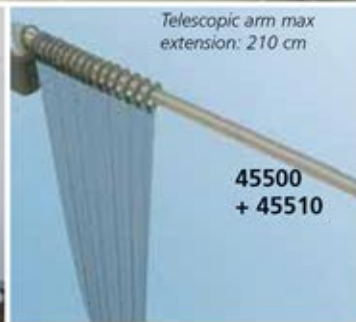

A COMPLETE SEPARATION SYSTEM

A complete system to create separations inside hospital rooms or outpatient wards.

System includes

4 STRUCTURES - include rings

- window curtain rails
- cabin curtain rail
- adjustable wall arms
- trolleys with 1 or 2 curtains

3 SIZES TREVIRA® CURTAINS IN 6 COLOURS - do not include rings

Window curtain rails

Available in 2 sizes: 160 cm (45492) need curtains 175xh 145 cm and 210 cm (45493) need curtains 225x145 cm

Cabin curtain rails

Size: 80x80 cm, need curtain 225xh 180 cm

Swing arm curtains - manual or electrical

Swing arm curtain is adjustable horizontally (180°) and can be bent down to 90° (45501 only) when not in use.

Telescopic tubular arm extension: open 210 cm, closed 88 cm (45500 and 45503) or 100 cm (45501).

Rings allow curtains to slide smoothly.

Trolley curtains - 1 or 2 curtains

Trolley made of stainless steel AISI 304 with 4 revolving castors (2 lockable). It allows the use of 1 curtain 225xh 145 cm (45505) or 2 curtains (45506), 1 long 225xh 145 cm and 1 short 175xh 145 cm. Arm can be bent down to 90° when not in use and curtain remains tied up.

code	STRUCTURE: ARM OR TROLLEY WITHOUT CURTAINS
45492	Window curtain rail 160 cm
45493	Window curtain rail 210 cm
45495	Cabin rail 80x80 cm
45500	Adjustable arm
45501	Adjustable foldable arm
45503	Electric adjustable arm*
45505	Trolley for 1 curtain - foldable
45506	Trolley for 2 curtains - foldable

*Adjustable horizontally (180°) by electrical control

Trevira® curtains

Trevira® curtains are flame-proof (Class I), antiallergic, avoid bacterial growth, waterproof and highly resistant to abrasion. Thick weft to avoid dust infiltration and improve privacy, washable up to 60°C. Available in 6 colours to match any need.

Custom-made curtains are available on request. Made in Italy.



TREVIRA CURTAINS			
FOR WALL ARMS AND CABIN	FOR TROLLEYS AND WINDOWS		COLOUR
225xh 180 cm	Long trolley arm/rail: 225xh145 cm	Short trolley arm/rail: 175xh145 cm	
45510	45520	45530	Light blue
45511	45521	45531	Blue
45512	45522	45532	White
45513	-	-	Beige
45514	-	-	Green
45515	45525	45535	Peach

Light blue

Blue

White

Beige

Green

Peach

SET OF 18 RINGS - SPARE	
45508	Open rings for window rails and cabin
45509	Closed rings for wall arms and trolleys

45508
 45509

PATIENT TROLLEYS - STRETCHERS



• **27800 PATIENT TROLLEY**
 • **27801 PATIENT TROLLEY - removable top**
 Made of chrome plated steel tube. Comes complete with mattress made in washable self extinguishing plastic material. Mounted on 4 castors Ø 100 mm two of which with brakes. Size: 180x54xh 80 cm. Load: 100 kg. Made in Italy.



code	PATIENT TROLLEY ACCESSORIES - not included
27810	Side rails (couple)
27811	I.V. Stands
27812	Steel basket
27813	Oxygen bottle holder

PROFESSIONAL WARD STRETCHER



GIMA code	WARD STRETCHER ACCESSORIES - not included
44761	Side rails (couple) with automatic locking device
44762	I.V. Stand with two hooks
44763	Basket - chrome plated steel
44764	Oxygen bottle holder* - chrome plated steel
44765	Fireproof simulated leather mattress - class I - 182x64x4 cm

* for oxygen bottle up to 41 cm, Ø 15,5 cm

• **44760 WARD STRETCHER**
 Main features:
 - **Platform:** all-welded mainframe made of semi-oval steel tube 50x25x2 mm.
 - **Push/Pull handle:** Made in steel tube Ø 30x1.5 mm.
 - **Surface finish:** Epoxy gloss finish standard grey 7040
 - **Mattress platform section:** Two section mattress platform fitted with removable chrome-plated grids made of 5 mm. Ø steel rods and square mesh 50x50 mm.
 - **Backrest:** Square cross section 25x25x1.5 mm, adjustable by means of a rack device (5 positions).
 - **Castors** - Four castors Ø 200 mm made of grey synthetic rubber two of which with independent brake.
 - **Bumpers:** Four bumpers at the corners made of anti-acid and anti-shock grey resin. Supplied disassembled.
 External size: 202x71xh 90 cm
 Wired net height: 78 cm
 Load: 135 kg.
 Manual: GB, FR, IT, ES, PT.
 Made in Italy.



PROFESSIONAL PATIENT TROLLEY - ADJUSTABLE HEAD SECTION

• **27804 PROFESSIONAL PATIENT TROLLEY** with adjustable head section, side rails and oxygen cylinder holder
 • **27805 PROFESSIONAL PATIENT TROLLEY - RADIOTRANSSPARENT FRAME** with adjustable head section, side rails and oxygen cylinder holder
 Innovative, stylish comfortable trolley easy to use. Trolley made in sturdy tubular frame for optimal stability. Supplied with 4 wheels Ø 200 mm (2 with brake), bumpers, push handle. Detachable frame with adjustable head section (27804) or fixed frame, 12 mm thickness, with adjustable head section (27805).
 Size: 196x76xh 75 cm. Net size: 193x68 cm
 Maximum load: 200 kg.
 Weight: 70 kg.
 Made in Italy.
 • **27807 MATTRESS - 186x68xh 8 cm - black**
 Simulated leather. Fire retardant. Class I IM.
 • **27808 IV STAND** with 2 plastic hooks.



ADJUSTABLE HEIGHT PATIENT TROLLEY WITH TR AND RTR

- **27806 PATIENT TROLLEY** - with adjustable height, TR and RTR
Stilish sturdy and comfortable trolley with innovative design allowing operators to easily treat patients. Adjustable in height by means of hydraulic pump with pedal placed on both sides. The lateral sides are very comfortable, easy and fast to fold. The upper wire mesh is removable to guarantee a better hygiene. Equipped with push handles, 4 bumpers at the corners and a universal hold-cylinder. Reclinable cushion thanks to two racks that can be easily actuated by the grip handle. Wheels: 200 cm diam. with total and simultaneous central brake; one of 4 wheels is equipped with directional brake; their activation is made by means of 4 lateral pedals. The joints of the structure rotate on self-lubricating sintered threaded inserts. The trolley can reach the Trendelenburg and anti-Trendelenburg position very quickly thanks to a handle placed on the upper lateral side: it activates a gas spring (600N) that offers millimetric adjustability. The entire structure made in rectangular and round tubular is epoxy painted in grey and white colour.
Size: 201x76xh 52/87 cm (without mattress).
Load: 130 kg. Weight: 90 kg
- **27807 MATTRESS** - 186x68xh 8 cm - black
Simulated leather, fire retardant. Class 1M
- **27808 IV STAND**



27806

27806 +
2780727806 +
27807

PROFESSIONAL PATIENT TROLLEYS WITH ADJUSTABLE BACKREST

- **27827 PROFESSIONAL PATIENT TROLLEY** - with adjustable backrest and side rails
Trolley made of anodized aluminium with steel perimetral frame with rigid PVC profile. Coated with epoxy powder RAL 1013 ivory. Rigid mattress platform made of powder coated steel welded mesh.
Main frame, side rails and shove handle bar made of anodized aluminium.
Nylon components with handle shape.
Swivelling castors Ø 200 mm, 2 of which with brake.
Delivered in kit from. Made in Italy.
- **27830 IV STAND** - fixed height 100 cm - 2 plastic hooks
- **27831 STEEL BASKET** - 56x38xh 9 cm
- **27832 OXYGEN BOTTLE HOLDER** - Ø 18x37 cm
- **27834 FIRE RETARDANT MATTRESS** 7 cm - black - 185x58xh 7 cm



27827

Overall size: 202x76x75 h cm
Mattres platform size: 190x160x75 h cm
Weight: 47 kg - Shipping volume 0.30 m³ - Load: 120 kg

ADJUSTABLE HEIGHT PATIENT TROLLEY WITH TR AND RTR

- **27828 ADJUSTABLE HEIGHT PATIENT TROLLEY** with Trendelenburg (TR), Reverse Trendelenburg (RTR) and side rails. Platform composed by two epoxy powder coated steel RAL 1013 ivory welded mesh sections, detachable for cleaning, fitted on nylon supports and placed on steel crossbar covered with rigid PVC profile. Raising and lowering by gas spring with lever set on the same section. Trolley structure with a rounded section profile coated with epoxy powder RAL 1013 ivory. Adjustable height by oleodynamic pump from 50 cm to 80 cm with foot control lever. TR-RTR position controlled by handle at the foot of the trolley. Mechanical braking. Inclination and platform check by a level bubble. TR 14° RTR 11°. Swivelling castors Ø 200 mm, one of which directional. Simultaneous braking with foot control lever with 3 positions: total brake, swivelling total, swivelling and directional. Made in Italy.
- **27830 IV STAND** - fixed height 100 cm - 2 plastic hooks
- **27833 OXYGEN CYLINDER HOLDER** (max. 7 l) and **WIRE BASKET** - multifunction
- **27835 FIRE RETARDANT MATTRESS** 10 cm - 2 sections - 185x58xh 10 cm

Easy and fast lock of IV stand
at main frame 4 corners



27828

Overall size: 202x76x75 h cm
Mattres platform size: 190x60x50/80 h cm
Weight: 88 kg - Shipping volume 0.65 m³
Load: 120 kg

TRENDELENBURG PATIENT TROLLEY - STRETCHER

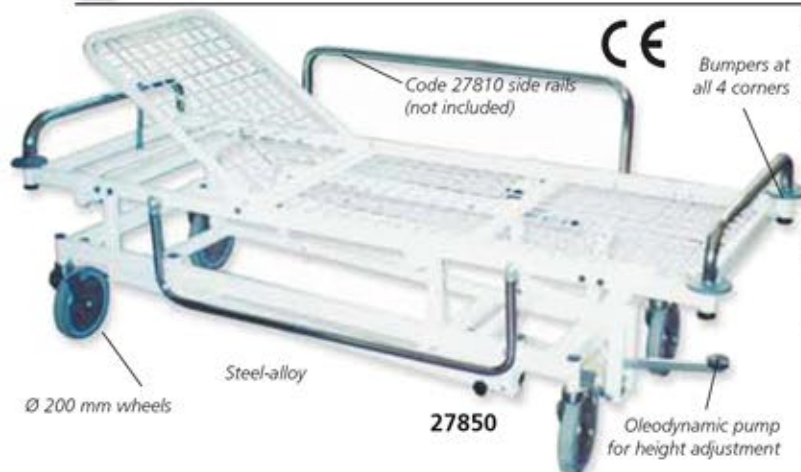

• **27850 TRENDELENBURG TROLLEY**
 Made of steel-alloy, oven painted ral 9010, with chrome plated handles.
 Adjustable height from 50 to 70 cm, with oleodynamic pump. Trendelenburg up to 9°.
 Anti-Trendelenburg up to 14° (with gas pump).
 Plastic bumpers at four corners. Maximum load: 120 kg.
 4 wheels of Ø 200 mm (2 with brake).
 Size: 65x184 (internal) x h 50-70 cm, 72x191 cm (external).

code	ACCESSORIES
27810	Side rails (couple) 100xh 28 cm
27853	I. V. Stands
27854	Oxygen bottle holder
27855	Mattress - black sky 3 cm thick in flame retardant material - 184x64x3 cm

HEIGHT ADJUST. ELECTRIC BED

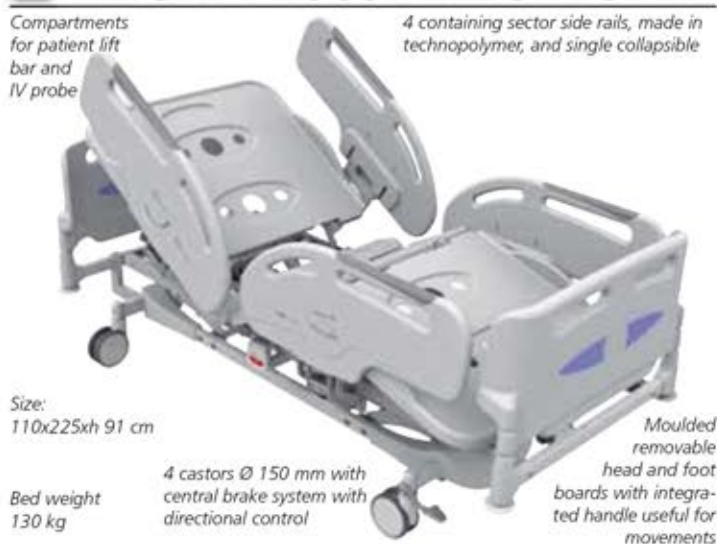

• **44800 HEIGHT ADJUSTABLE ELECTRIC BED**
 3 joint, 4 section Hospital bed, with electronic adjustment of height and platform, Trendelenburg and Reverse Trendelenburg positions (15°). All steel components are epoxy-coated with anti-microbial additive. Back section regulation using electric actuators with anti-crushing and rototranslation function to avoid abdominal crushing. Both bed sides have CPR manual levers for emergency manoeuvres. Foot rest adjustment by click mechanisms allowing 6 positions. Internal side rails controls for patient use and caregiver. Remote control to maintain position or disable by magnetic key.
 The keypad allows adjustment of backrest, bed surface height, legs and foot rest, comfort position, Trendel and reverse Trendel.

• **44801 LIFTING POLE**
 • **44802 IV POLE**
 • **44803 FLAME RETARDANT MATTRESS with waterproof cover**
 Load 280 kg. Density 35 kg/m². Size 85x195x18 cm.

TECHNICAL SPECIFICATIONS

Minimum/maximum height surface: 380-780 mm
 Maximum backrest regulation: 70°
 Maximum leg/foot height regulation: 30°
 Trendelenburg/reverse trendelenburg: 15°
 Minimum/maximum height: 835-1235 mm
 Maximum total width/length: 1010/2260 mm (bumpers and siderails included)
 Worksurface width/length dimension 880/2000 mm
 Power supply: 160-230 V - 50-60 Hz
 Dynamic lift capacity: 230 kg
 SWL: 270 kg
 IEC protection class: I / B
 IP code (protection rating): IP66
 Made in Italy

BARIATRIC ELECTRIC BED

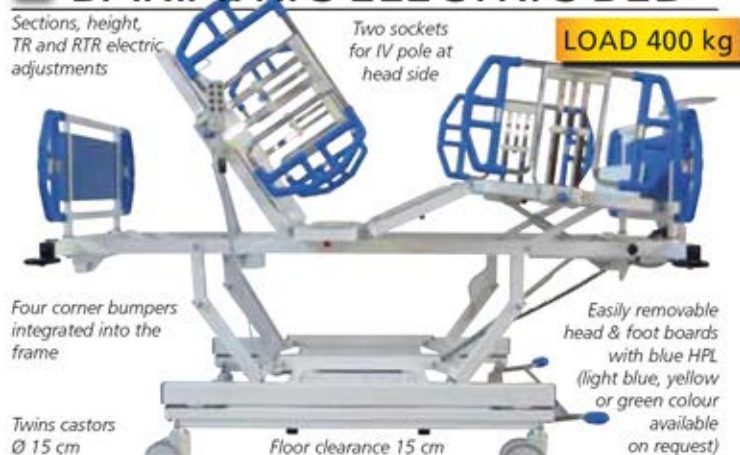

• **27636 EXTENDABLE BARIATRIC BED - electric, 4 sections**
 Four section electrically driven bed frame in durable steel construction with adjustable height and TR-RTR. Made in Italy.
 - Trendelenburg 18° and Reverse Trendelenburg 18°
 - mattress platform positioning: backrest 0°-52°, legrest 0°-24°
 - manual handset with locking key-supervisor to adjust sections
 - electric CPR function
 - armchair position with excellent comfort
 - carer controlled lock out function for all controls
 - battery backup
 - central braking system with a three position pedal on foot side for greater control: steering / swivelling / braking
 - 3X standard twin castors Ø 15 cm and 1 antistatic and steering twin castor
 - 4 multi position and removable siderails, colour co-ordinated to bed frame

• **27638 LIFTING POLE with integrated IV hooks**
 • **27639 RETRACTABLE BLANKET TRAY**
 • **27640 IV POLE**
 • **44810 FLAME RETARDANT BARIATRIC MATTRESS - 4 pieces with waterproof transpirant cover.** Load 300 kg. Density 40 kg/m². Size 90x200x18 cm (2 sides 15x200x18, 1 foot 15x120x18)



TECHNICAL SPECIFICATIONS

Bed upper frame dimensions: - fully retracted - 226x105 cm (bumpers included)
 - fully extended - 242x135 cm (siderails included)
 Mattress platform adjustments: - fully retracted - 200x90 cm
 - intermediate position - 200x105 cm
 - fully extended - 200x120 cm
 - foot extension - from 200 to 220 cm
 Lowest-Highest position: 41-81 cm
 Bed weight: 175 kg Load capacity: 400 kg
 Electrical shock protection: Class 1 Liquid ingress protection: IP 66

MECHANICAL AND SEMI AUTOMATIC OPERATING TABLES

- 90% RADIOTRANSparency ON TOP
- 100% STAINLESS STEEL
- COMPLETE MOVEMENTS



STAINLESS STEEL, RADIOSURGICAL OPERATING TABLES

Designed to satisfy surgical functionality, practicality, quickness and easy maintenance. They allow, with proper accessories, to satisfy every basic surgical activity

- Table top

Divided in 5 sections (head, back, pelvis, 2 independent leg sections) with stainless steel structure and plexiglass to allow x-ray permeability and easy cleaning.

Table top is pre-arranged for the insertion of x-rays holders all over its length. Accessories holder (25x10 mm) in stainless steel, covers table top length on both sides.

- Telescopic column

Square and of limited size, covered by anodized aluminium (27560) or stainless steel (27562/4/5/6)), it allows up and down movement (approx. 70-100 cm) by a foot pedal placed at the base through a closed oleodynamic circuit with oil-tight pump avoiding any oil leakage (27560/2/4) or by remote control (27565/6).

- Mattresses

They cover all the table top length, made in a long lasting material, sterilizable in autoclave, x-ray translucent and elastics. They are independently removable.

- Base

For Solaris, it is moveable by four large antistatic castors, 2 directional and 2 pivoting with brake. For Gima and Gima TR

(mechanical and semi-automatic) base is completely made of stainless steel to ensure perfect stability. It is provided with a locking system to the floor through a foot bar. Transport is allowed by 3 antistatic wheels, one pivoting and 2 directional.

- Movements

For Solaris: Trendelenburg and Reverse/Trendelenburg with lateral tilt right-left 20° by crank. For Gima and Gima TR same table movements as above, work through a mechanical system moved by two cranks, positioned at the side, easily retractable, for semiautomatic by remote control.

- Longitudinal translation

Both Gima TR models offer manual longitudinal translation of table top of about 300 mm to allow total elimination of column encumbrance for 100% transparency of top.

- Full range of accessories. All tables come with mattress included, semiautomatic also includes control (with 1 m cable) batteries and crank for emergency of engine.

All operating tables are made in Italy.



code	OPERATING TABLES
27560	Solaris operating table - mechanical
27562	Gima operating table - mechanical
27564	Gima TR operating table with longitudinal translation of table top - 100% radiotransparency
27565	Gima operating table - semiautomatic - need 27559
27566	Gima TR operating table - semiautomatic with longitudinal translation of table top - 100% radiotransparency - need 27559
ACCESSORIES FOR ALL OPERATING TABLES - 100% stainless steel	
27568	Wristlet with clamp - couple
27569	Rectangular s/s gynaecological basin - 200x320x150 mm
27570	Two-hook adjustable IV stand (needs clamp 27571)
27571	Clamp for IV stand
27572	Arm holder adjustable 90-180° with cushion and clamp
27573	Drape support with adjustable height with 2 clamps 27576
27576	Clamp for drape support - spare
27574	Leg holder with radio transparent valve and cushion - couple (needs 2 clamps 27575)
27575	Clamp for leg holder
ACCESSORIES FOR SEMIAUTOMATIC TABLES (27565-6)	
27558	Infrared control
27559	Battery charger

	TECHNICAL SPECIFICATIONS		
	27560	27562-27564	27565-27566
Table top size	200x48 cm	200x48 cm	200x48 cm
Height	70-100 cm	75-105 cm	75-105 cm
Lifting system	Mechanical	Mechanical	Electric
- Trendelenburg	30°	35°	35°
- Reverse Trendelenburg	30°	25°	25°
- Lateral tilt right-left	20°	25°	25°
Table top composition	extractable and inclinable (+25° -90°)		
- Head section	by gas spring		
- Back section inclination	-40° +80°	-20° +80°	-20° +80°
- Pelvis section size	size 48x51 cm		
- Leg section	size 48x49 cm		
	divided in two independent sections with following manual movements		
	• opening right/left of 0°/90°		
	• inclination +30° -90°		
	• both parts are easily independently extractable		
Table weight:	90 kg	160 kg	160 kg
Operating table capacity:	200 kg	250 kg	250 kg
Made in Italy			

ISO SERVICE TROLLEYS - MADE IN ITALY



Size: 65x47xh 100 cm
Weight: 12.5 kg

27935

Pivoting castors
Ø 100 mm
(2 with brake)

• **27935 ISO SERVICE TROLLEY - empty**
Service trolley for "ISO" trays or baskets (not included) made in epoxy powder painted steel. Supplied with 5 height adjustable + 1x27924 runners for 3x27938 ISO 1x27939 trays/baskets.

Both side basket pulling out with stopper to avoid accidental fall.



Size: 59x99.3xh 88 cm

Adaptable to any model of ISO 600x400 baskets and trays thanks to the special rail sides, which allow an easy sliding and pull out.

27934



4 wheels Ø 125 mm
(3 with brake)

• **27934 AURION MINI 600 - ISO trolley - empty**
Basic body made in Baydur Polyurethane - Bayer AG: it can be washed and disinfected. It does not react with diluted acids, alkali and solvents. Self-extinguishing according to class UL V0 - Latex Free. For safety, handles are moulded into the body on both sides, trolley top has a 4-sided moulded containing rim to avoid any spilling/falling of materials. No sharp edges. All around bumper. Lightweight and easy to move.

Lockable with double key



27936

Equipped with key lock and doors kit made in transparent polycarbonate.

Side plastic runners for "ISO" trays or baskets

• **27936 ISO TRANSPORT TROLLEY - empty**
Transport trolley for ISO trays and baskets (not included). Made in stainless steel AISI 304 sheet, scotch brite finishing. Anti-dust gasket. Internal side with plastic runners for ISO trays or baskets. Supplied with handle for transport.

(baskets and trays not included)

Handle for transport

27936



Antistatic castors
Ø 125 mm (2 with brake)

ISO FORMAT UNIVERSAL MODULAR TRAY SYSTEM

ISO MODULAR TRAYS GREY ABS

Closed	Open	SIZE mm
27924	-	600x400x50
27925	27938	600x400x100
27928	27939	600x400x200

TRANSPARENT PC

Closed	Open	SIZE mm
27957	-	600x400x50
27958	27965	600x400x100
-	27966	600x400x200

Intelligent solutions for storing all kind of drugs, bandages, accessories and small components in a space saving and clear manner.



27996

27995

code	DIVIDERS
27994	400x50 mm
27995	600x50 mm
27996	400x100 mm
27997	600x100 mm
27998	400x200 mm
27999	600x200 mm
28001	Drawer stopper



INOX WORKING TABLE

OPERATING THEATRE INSTRUMENT TABLES



27909

• **27909 INOX WORKING TABLE**
Working table, equipped with two drawers (47x30x12 cm) each side, to work on both sides. Stainless steel AISI 304 frame, structure made of square tubular, table top and lower shelf made of smooth stainless steel. Mounted on 4 castors Ø 100 mm, two with brakes. Weight 50 kg. Size 120x70xh 95 cm. Max load (x shelf): 40 kg. Delivered in kit form 122x35x72 cm. Made in Italy.

Shelf size: 120x65 cm



27913

• **27913 INSTRUMENT TABLE 2 SHELVES**
Operating room instruments table made of stainless steel AISI 304 scotch brite finish. 125 mm Ø revolving castors (2 with brake). Weight: 28 kg. Load for shelf: 40 kg. Size: 120x65xh 95 cm. Delivered in kit form (123x13x68 cm). Made in Italy.

Stainless steel adjustable
105-136 cm upper part
with 4 instrument hooks.



27914

• **27914 INSTRUMENT TABLE 1 SHELF**
Operating room instruments table made of stainless steel AISI 304, scotch brite finish. 125 mm Ø revolving castors (2 with brake). Weight: 21 kg. Load: 40 kg. Size: 120x65xh 95 cm. Delivered in kit form (123x13x68 cm). Made in Italy.

OPERATING ROOM INOX CABINETS



27917

• **27917 INOX CABINET**
Made of AISI 304 stainless steel.
Two lockable doors (10/10 thickness),
4 adjustable shelves (8/10 stainless),
4 adjustable feet, with stainless steel
cover. Size: 100x48xh 190 cm.
Weight: 130 kg.
Made in Italy.



27918

• **27918 GLASS-INOX CABINET**
Made of AISI 304 stainless steel with
two lockable doors in tempered glass
5 mm thick, 4 shelves in tempered glass
6 mm thick and 4 adjustable feet.
Size: 100x48xh 190 cm. Weight: 105 kg.
Made in Italy.

PAINTED STEEL CAB



27916

• **27916 PAINTED STEEL CABINET**
Epossidic powder painted
steel cabinet with 4 adjustable
shelves, lockable doors,
4 adjustable feet.
Size: 100x50xh 200 cm.
Made in Italy.

SHELVING SYSTEM



27908

• **27908 SHELVING SYSTEM**
Shelving system, made of AISI 304
stainless steel, scotch brite finish.
With 5 stainless steel reinforced shelves
at fixed position.
Possibility to fix
together several
shelving systems.
Size: 100x50xh 200 cm
Load x shelf: 25 kg
Weight: 30kg
Made in Italy.



INSTRUMENT TROLLEY



27442

• **27442 INSTRUMENT TROLLEY**
Made of satined welded AISI 304
stainless steel. With 4 sliding drawers
(internal, 49x33xh 18 cm)
Top drawer lockable, upper shelf with
safety edges to carry instruments.
4 revolving castors Ø 80 mm
Size: 60x40xh 110 cm
Weight: 37 kg
Made in Italy.

ANAESTHETIC TROLLEY



27437

• **27437 ANAESTHETICS TROLLEY**
Made of satined AISI 304 stainless steel,
with 6 drawers (internal 26x37xh 7 cm),
a lockable vertical compartment and an
open space.
Top with 3.5 cm upstand.
4 revolving castors Ø 80 mm
Size: 60x40xh 110 cm
Weight: 39 kg
Made in Italy.

STAINLESS STEEL, INSTRUMENT AND DRESSING TROLLEYS



27430

• **27430 INOX TROLLEY**
AISI 304 Stainless steel trolley with plastic drawer internally divided in 4 sectors. 2 shelves with upstands (3,5 cm) on four sides. Revolving rubber castors Ø 80 mm (two with brake).
Size: 70x50xh 82 cm.
Max load (x shelf): 25 kg.
Delivered in kit form.
Made in Italy.



27433

*Delivered in kit form.
Made in Italy.*

• **27433 MEDICAZIONE TROLLEY - small**
Size: 60x40xh 81 cm - weight 8 kg
• **27434 MEDICAZIONE TROLLEY - medium**
Size: 70x50xh 82 cm - weight 9 kg
• **27435 MEDICAZIONE TROLLEY - large**
Size: 90x60xh 85 cm - weight 15 kg
AISI 304 stainless steel trolleys, with push handle, 2 shelves with upstands (3,5 cm) on four sides, 4 revolving rubber castors Ø 60/80/90 mm. Max load (x shelf): 25 kg.



27431

• **27431 TER TROLLEY**
AISI 304 Stainless steel trolley, with push handle.
3 shelves with upstands (3,5 cm) on four sides, 4 revolving rubber castors Ø 80 mm.
Size: 70x50xh 82 cm - weight 13 kg
Max load (x shelf): 25 kg
Delivered in kit form.
Made in Italy.



27436

• **27436 DRESSING TROLLEY**
Dressing trolley made of AISI 304 stainless steel with 2 shelves (70x50 cm), 1 drawer (40x50xh 15 cm), basin holder and basin. 4 revolving castors Ø 100 mm.
Size: 70x50xh 85 cm - weight: 18 kg.
Max load (x shelf): 25 kg.
Delivered in kit form. Made in Italy.



45800

• **45800 MEDICAZIONE PLUS TROLLEY**
With removable trays
Stainless steel frame mounted on castors Ø 80 mm.
Size: 61x43xh 78 cm. Weight: 10 kg.
Maximum load (x shelf): 10 kg.
Delivered in kit form.
Made in Italy.



45805

• **45805 TER PLUS TROLLEY**
With removable trays
Stainless steel frame, mounted on castors Ø 80 mm.
Size: 49x30xh 78 cm. Weight: 9 kg.
Maximum load (x shelf): 10 kg.
Delivered in kit form.
Made in Italy.

LANCART: STAINLESS STEEL TROLLEY TO BUILD UP

• **45810 LANCART TROLLEY - small**
Size: 60x40xh 80 cm
• **45811 LANCART TROLLEY - medium**
Size: 70x50xh 80 cm
Stainless steel trolley mounted on castors Ø 80 mm. Maximum trolley load: 60 kg.
Delivered in kit form. Made in Italy.
You can add following accessories:
• **45815 SET OF SIDERAILS (for 1 shelf)** for 45810
• **45816 SET OF SIDERAILS (for 1 shelf)** for 45811
• **45817 BOTTLE RACK**
• **45818 WASTE BIN**



Size:
60x40xh 80 cm

45810



Set of siderails

BUILD UP YOUR TROLLEY

Waste bin

Bottle rack

45810
+ 2 x 45815
+ 45817
+ 45818

ANODIZED ALLOY OR ALUMINIUM TROLLEYS

REX TROLLEY



27429

- 27429 GIMA 2 TROLLEY
 - small: 60x40xh 77 cm - weight 11 kg
 - 27425 GIMA 2 TROLLEY
 - medium 70x50xh 78 cm - weight 14 kg
- Practical trolleys with aluminium body and handles. With 2 white bilaminated shelves 18 mm thick, black PVC bordered, with guard-rail. Two large lateral handles facilitate transport or lift up of the trolley. 4 revolving nylon castors Ø 80 mm. Max load (x shelf): 40 kg.
- 27426 GIMA 3 TROLLEY
 - medium 70x50xh 78 - weight 15 kg.
- Same as GIMA2, but without guard rail. Delivered in kit form. Made in Italy.



TOP QUALITY

27461

- 27460 DELUXE TROLLEY
 - 27461 DELUXE TROLLEY with drawer 62x42 cm
- Size: 65x45xh 80 cm
Top quality trolleys made of lightweight anodized special alloy, with detachable stainless steel shelves. 4 revolving rubber castors Ø 80 mm. Max load (x shelf): 15 kg. Delivered in kit form. Made in Italy.



27439

- 27439 REX TROLLEY
- Complete stainless steel dressing trolley. Supplied with 3 shelves, waste bin, drawer, support for bottles, guard rails on the two bottom shelves, 4 wheels, Ø 100 mm (2 with brakes). Size: 79x50xh 120 cm (handle included). Delivered in kit form (75x52x112 mm). Drawer 64x43xh 9.5 cm. Made in Italy.

BOWL STANDS

- 27456 SINGLE BOWL STAND
 - 27457 DOUBLE BOWL STAND
- Chrome plated steel stand with stainless steel base and 5 plastic wheels, one with brake. Adjustable height from 60 to 95 cm. Stainless steel bowl Ø 32 cm, 4 l capacity included. Available with one or two bowls. Delivered in kit form.
- 27459 S/S BOWL Ø 32 cm - spare

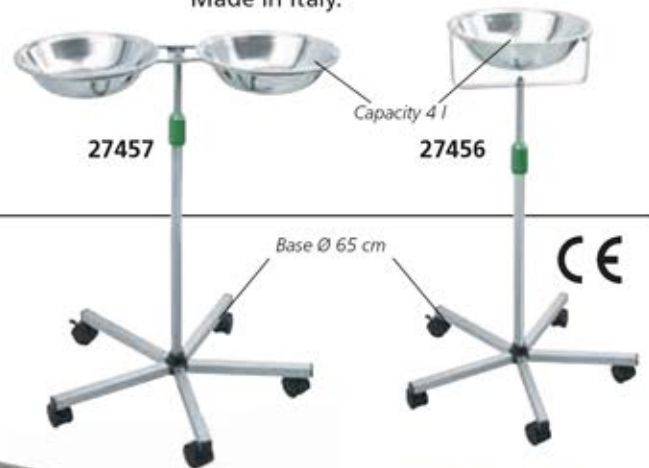

27457

Capacity 4 l

27456

Base Ø 65 cm



MAYO TABLES



27453



27455

27454



Tray internal size: 70x45xh 1.7 cm

45832

Height adjustable 90-115 cm

45830

- 27453 MAYO TABLE - 5 spokes
- S/s tray, 5 spokes with castors, Ø 50 mm and adjustable height. Delivered in kit form. Made in Italy.

- 27454 MAYO TABLE - s/s base
 - 27455 MAYO TABLE - s/s base and pump
- With removable s/s tray, s/s AISI 304 base with 4 castors (50 mm) and adjustable height. Delivered in kit form. Made in Italy.

- 45830 MAYO TABLE - U-SHAPE
 - 45832 MAYO TABLE - 5 spokes
- Stainless steel base with castors Ø 50 mm: 5 spokes (45832) or U-shape (45830). Stainless steel frame and removable tray. Adjustable height. Delivered in kit form. Made in Italy.

TECHNICAL SPECIFICATIONS

	27453	27454	27455	45830-45832
S/S tray size:	68x46 cm	68x46 cm	70x45xh 1.8 cm	70x45xh 1.7 cm
Adjustable height:	70-110 cm	70-110 cm	85-120 cm	90-115 cm
Weight:	8 kg	12 kg	19 kg	10 kg
Load:	20 kg	20 kg	25 kg	10 kg

BAG HOLDER TROLLEYS



45905+45910



45906+45910

- 45905 BAG HOLDER TROLLEY - 2 bags
 - 45906 BAG HOLDER TROLLEY - 3 bags
- Bag holder trolleys with pedal operated opening. Rigid, sturdy, self-supporting ABS plastic base with edges. The bag holding ring (35x25.5 cm) is made of glass reinforced nylon with a rubber gasket to hold the bag in place. Two vertical tubes made of AISI 304 stainless steel are



45905+27462+27466+45910

welded to the base and carry the bag holding ring. Non marking grey rubber swivelling wheels Ø 80 mm (two with pedal operated brake). Made in Italy.

- 45910 PUSH HANDLE
 - 27466 WRAPPING BAG - yellow strip
 - 27462 WRAPPING BAG - blue strip
 - 45908 WRAPPING BAG - green strip
- White synthetic bag with strip, washable up to 200 times. Size 57xh 103 cm. Made in Italy.

SHUT BAG HOLDER



45900

- 45900 SHUT BAG HOLDER - 70 l
- Trolley suitable for carrying one 70 l bag (not included). Stainless steel AISI 304 structure. Equipped with swivelling castors with brake and bumpers. For use with standard 70 l plastic bag. Can use also wrapping bag (27462, 27466, 45908) Made in Italy.



LAUNDRY TROLLEYS



Wrapping bag not included
27465 + 27462

- 27464 LAUNDRY TROLLEY - painted steel
 - 27465 LAUNDRY TROLLEY - stainless steel
- These trolleys allow to collect dirty laundry while distributing clean linen at the patient bedside. Stainless steel or painted steel frame. Equipped with 4 Ø 125 mm castors (2 with brake) and 4 rubber bumpers at corners. Size: 135x65xh 102 cm. Made in Italy.
- 27463 SIDE PANEL - painted steel
 - 27466 WRAPPING BAG - yellow strip
 - 27462 WRAPPING BAG - blue strip
- washable up to 200 times, 57xh 103 cm



27464+27462

27465+27462+27463



45915

- 45915 LAUNDRY TROLLEY - laminated
- Closed trolley with doors, 3 shelves plus top and 2 bag holders. Laminated particle board body and stainless steel AISI 304 structure. Equipped with swivelling castors, 2 with brake and bumpers. Size: 110x66x132 cm. Made in Italy.
- 27462 WRAPPING BAG - blue strip
 - 27466 WRAPPING BAG - yellow strip
- White washable laundry synthetic bag with yellow or blue strip. Size: 57xh 103 cm. Made in Italy.



SOILED LINEN



Canvas bag included

27467

- 27467 SOILED LINEN TROLLEY
 - 27468 DOUBLE SOILED LINEN TROLLEY
- Chrome plated frame with 3 or 4 castors Ø 80 mm. Removable bag. Size: Ø 46xh 90 cm. Delivered in kit form.



27468

Size: 92x90 cm

MULTIFUNCTIONAL CARTS - MADE IN ITALY

SMART CARTS

BUILD UP YOUR FAVOURITE CART



Compatible with 4 hook metal support 27846

27870



27870 + 27872



27870 + 27888



27870 + 27873 + 27874



With VESA 75/100 connection for monitor

27869 + 27873



Aluminium structure

Shelves made with coat of paint sheets

27896 + 27874

Wheel load: dynamic charge: 70 kg static: 140 kg

SUPER EASY CART: A new stylish and quality cart you can build according to your needs

TECHNICAL SPECIFICATIONS

Dimensions: 47x42x79 cm
Shelf: 32x26 cm or 40x36 cm
Load capacity: total load 120 kg shelf 10 kg
4 castors Ø 80 mm (2 with brake)
Material: - extrusions in aluminium
- plastic parts in ABS
Shelf: steel sheet epoxy powder coated

code	SUPER EASY CARTS - WITH HANDLE
27870	Cart with 1 shelf (32x26 cm)
27869	Cart with shelf (40x36 cm), monitor support
27871	Cart with large shelf (40x36 cm)
ACCESSORIES for all SUPER EASY CARTS	
27872	Extra shelf 32x26 cm
27873	Basket
27874	Infusion stand
27875	Extra shelf 40x36 cm
27888	Cardio arm for ECG

SMART CART - grey/white RAL 7035
Carts with 3, 4 or 5 wide, sturdy shelves
4 castors Ø 80 mm (2 with brake).

code	SMART CARTS
27895	Cart h80 cm 3 shelves 40x36 cm
27896	Cart h90 cm 4 shelves 40x36 cm
27897	Cart h115 cm 5 shelves 40x36 cm
27873	Basket
27874	Infusion stand
27888	Cardio arm for ECG

TRIS TROLLEY



27438

• **27438 TRIS TROLLEY**
A practical trolley for ECG, Electrosurgical unit or any other device, with 4 nylon castors and 2 lateral handles for easy moving. Revolving castors Ø 50 mm. Size: 49x37xh 77 cm. Shelf size: 40x30 cm. Colour: RAL 9002
Delivered in kit form.
Made in Italy.

EASY CARTS - MADE IN ITALY

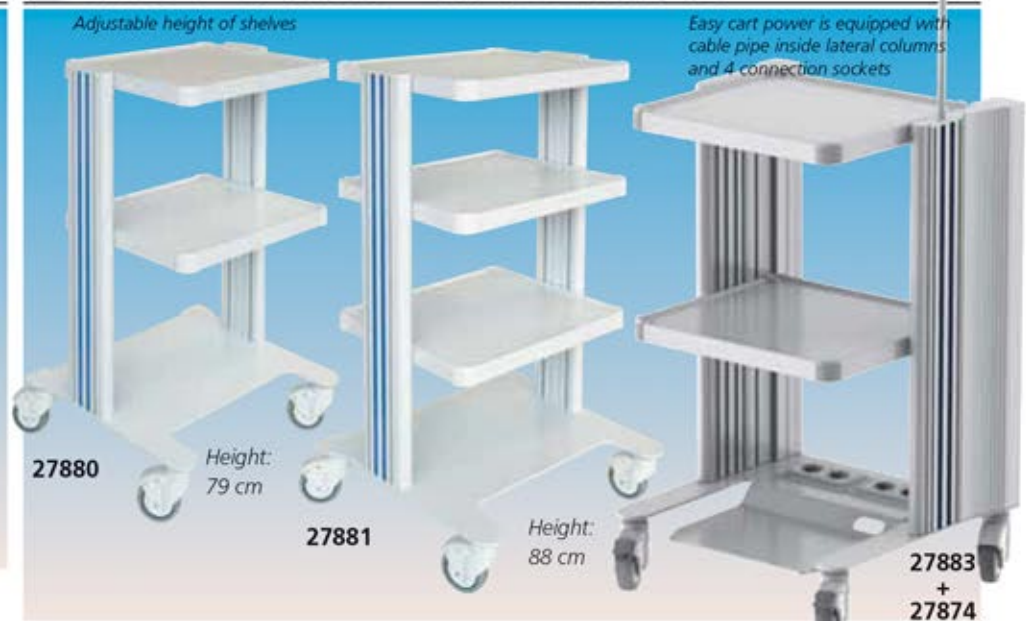

27880

Height: 79 cm

27881

Height: 88 cm

27883 + 27874

EASY CART
A complete line of stylish and sturdy carts with 3, 4 or 5 shelves and with power.

TECHNICAL SPECIFICATIONS

Dimensions (WxDxH): 50x45x79/88/112 cm
Load capacity: total load 140 kg shelf 25 kg
Shelves: 40x36 cm
4 castors Ø 80 mm (2 with brake)
Material: - vertical aluminium extrusions
- plastic parts in ABS
Shelf: steel sheet epoxy powder coated

code	EASY CARTS
27880	Cart h79 cm 3 shelves 40x36 cm
27881	Cart h88 cm 4 shelves 40x36 cm
27882	Cart h112 cm 5 shelves 40x36 cm
27883	Cart power h79 cm 3 shelves 40x36 cm
ACCESSORIES EASY CARTS	
27873	Basket 30x16xh 14.5 cm
27874	Infusion stand
27884	Extra shelf 40x36 cm
27888	Cardio arm for ECG

DOUBLE FACE PHARMACY TROLLEY - MADE IN ITALY



• **27499 DOUBLE FACE PHARMACY TROLLEY - 3 large, 30 small drawers**
Two trolleys in one: 3 large drawers on one side, 30 (6+9+15) monodose cassettes on other side; with locking system.
Size of cassettes:
- 6 cassettes 115x290xh 75 mm
- 9 cassettes 115x290xh 45 mm
- 15 cassettes 70x290xh 45 mm
Size of trolley: 920x590xh 810 mm
Provided with 4 revolving castors Ø 125 mm (3 with brake, 1 of trolley, antistatic).



• **45730 DOUBLE FACE PHARMACY TROLLEY - 3 large, 22 small drawers**
Two trolleys in one: 3 large drawers on one side, 22 (6+6+10) monodose cassettes on other side; with locking system.
Size of cassettes:
- 6 cassettes 115x290xh 75 mm
- 10 cassettes 115x290xh 45 mm
Size of trolley: 920x590xh 810 mm
Provided with 4 revolving castors Ø 125 mm (3 with brake, 1 of trolley, antistatic).



• **45731 DOUBLE FACE PHARMACY TROLLEY - 62 small drawers**
Two trolleys in one: 31 (6+10+15) monodose cassettes on both sides; with locking system.
Size of cassettes:
- 6 cassettes 115x290xh 75 mm
- 10 cassettes 115x290xh 45 mm
- 15 cassettes 70x290xh 45 mm
Size of trolley: 920x590xh 810 mm
Provided with 4 revolving castors Ø 125 mm (3 with brake, 1 of trolley, antistatic).



DOCTOR TROLLEY



• **27446 DOCTOR TROLLEY**
Useful trolley made of plastic material (ABS) provided with 9 drawers of different sizes.
Height of drawers: two 8.5, five 5.5, two 2.7 cm. Size: 38x30xh 72 cm.
Made in Europe.

EXCEL TROLLEY



Castors Ø 100 mm (2 with brake).
Excel Trolleys are produced without upstands at four sides for an easier cleaning.
• **27440 EXCEL TROLLEY - 3 shelves (60x45cm) Size: 67x69xh 80 cm.**
• **27441 EXCEL TROLLEY - 4 shelves (60x45cm) Size: 67x69xh 110 cm.**
Maximum load: 80kg
Delivered in kit form. Made in Italy.

PROFESSIONAL KARTS

Made in Italy

All professional carts are supplied with cable pipe inside lateral columns.



• **27885 PRO CART 2 shelves - h 80 cm**
• **27887 PRO CART 2 + keyboard, monitor support**
• **27883 BASKET**
• **27884 INFUSION STAND**

TECHNICAL SPECIFICATIONS

Load capacity: - total load 240kg - shelf 35kg
Base: 60.8x50 cm
Shelves: 2 shelves 50x50 cm + base
Material: - vertical extrusions in aluminium
- plastic parts in ABS
Made in Italy

DRUGS & MEDICINE TROLLEYS - MADE IN ITALY



27495



27497



27494

- 27494 PHARMACY TROLLEY - small with 15 3-compartment partition
- 27495 PHARMACY-TROLLEY - standard with 20 3-compartment partition
- 27497 PHARMACY TROLLEY - large with 30 3-compartment partition

A portable pharmacy, allowing to manage daily or weekly treatment of patients, with 15/20/30 3 compartments small drawers for easy drug storage (45-60-90 spaces). Painted steel frame, technopolimer surface and panels. Can be completely closed by safety key lock. Provided with 4 revolving castors Ø 125 (2 with brake); Size 820/1150x640xh 1,000 mm.

- 27498 PARTITION - 3 compartments - spare



4 x 27498

27498

DRUGS & MEDICINE CABINETS - MADE IN ITALY



27942, 27944



27941



MEDICINE CABINETS 100x60xh 195 cm
 With drugs compartment, 48 medicine compartments and 5 adjustable shelves
 - made in bilaminated board (27944/5) or melamine board (27942) 20 mm thick
 - epoxy powder painted steel base frame with 4 adjustable feet Ø 50 mm
 - 2 external lockable doors turning through 180° with 8 medicine compartments each (extendable to 10 compartments)
 - perimetrical anti-dust gaskets
 - inside 2 containers with 8 medicine compartments each side (extendable to 10 compartments) turning through 90°
 - dangerous drugs compartment provided with lock



• 27941 COMBO MEDICINE CABINETS
 With 24 medicine compartments one side and 6 ISO tray 1 shelf and 3 drawers other side
 - made in bilaminated board 20 mm thick
 - epoxy powder painted steel base frame with 4 adjustable feet Ø 50 mm

Right side

- 1 external lockable door turning through 180° with 8 medicine compartments each (extendable to 10 compartments)
 - perimetrical anti-dust gaskets
 - inside 1 container with 8 medicine compartments each side (extendable to 10 compartments) turning through 90° provided with lock

Left side

- glass door, internal side with runners for ISO trays
 - 3 drawers on the bottom
 Supplied with 6 ISO trays different heights (2xh 5 cm, 3xh 10 cm and 1xh 20 cm) and 1 shelf.



- 27946 COMPARTMENT FOR MEDICINE - spare

code	MEDICINE CABINET	Material	Colour							
27942	Medicine cabinet	melamine particle board	white							
27944	Medicine cabinet	bi-laminated board	white							
27945	Medicine cabinet	bi-laminated board	any colour*							
27946	Compartment for medicine									
Colours:	412	431	441	452	482	484	499	854	861	1818

*You have to indicate requested colour with order. Available in 30 days

MULTI-FUNCTIONAL TROLLEYS: BASIC AND DRESSING

MULTIFUNCTIONAL TROLLEYS: BASIC - DRESSING

These multifunctional professional trolleys have painted steel structure and external plastic finishing. Basic and Dressing are available in 3 different sizes (small, standard, medium). Provided with 4, 8 or 9 drawers, one lateral basket and one extra lateral table. Four swivelling rubber castors Ø 125 mm (2 with brake). Made in Italy.

BASIC



45702
Standard

BASIC TROLLEY - 3 sizes

Standard version without accessories

DIVIDER KIT - size: 20/35/50x43xh 7 cm

- 27470 KIT for drawer 30 cm - 8 compartments
- 27471 KIT for drawer 45 cm - 20 compartments
- 27472 KIT for drawer 60 cm - 25 compartments



Partitions are removable



27476
Standard



27477
Small

DRESSING



27481
Standard



45701
Small



27484
Medium

DRESSING TROLLEY - 3 sizes

Same as Basic, but equipped with instrument tray and upper dispenser (10 tilting bins).

BASIC		DRESSING		Size Type	Size of trolley (cm) (without accessories)	Number of drawers	Size of drawers cm					
Yellow	Blue	Yellow	Blue				45x48xh13	45x48xh27	60x48xh13	60x48xh27	30x48xh13	30x48xh27
27477	45700	27478	45701	Small	67x64xh 100	4	3	1	-	-	-	-
27480	45702	27481	45703	Standard	82x64xh 100	4	-	-	3	1	-	-
27476	45704	-	-	Standard	82x64xh 100	9	-	-	-	-	8	1
27483	-	27484	-	Medium	102x64xh 100	8	3	1	-	-	3	1
27486	-	-	-	Large	115x64xh 100	8	-	-	3	1	3	1

RECORD HOLDERS AND X-RAY FILM HOLDERS TROLLEYS



- 27490 RECORD HOLDERS TROLLEY - sliding top
 - 27491 RECORD HOLDERS TROLLEY
 - 27492 RECORD HOLDERS TROLLEY - 2 large drawers
- Record trolleys are designed to hold clinical reports in A3/A4 format or specific format. Frame in epoxy painted steel, working surface and panels in technopolimer plastic. Equipped with 4 Ø 125 mm swivelling rubber castors (2 with brake). Bumpers around the perimeter. Made in Italy. Size: 820x640xh 1,000 mm (code 27491 and 27490) 820x640xh 1,150 mm (code 27492).
- 27493 FILE RACK A3 special

- 27488 X-RAY FILM HOLDER
- This trolley has 32 extractable compartments, a wide top surface, 4 side document holders, and a sliding out writing surface. Frame is in painted steel with sliding-in bilaminated doors with a 270° opening. Base and lateral cabinets are made in technopolimer material. Equipped with 4 Ø 125 mm swivelling rubber castors (2 with brake). Size 820x640xh 1, 200 mm. Made in Italy.
- 27489 COMBO FILES AND X-RAY FILM HOLDER
- Same as above, but with 15 X-ray compartments and drawer that holds up to 25 files (not included).

EMERGENCY TROLLEYS

EMERGENCY TROLLEYS - small and standard

Professional trolley with painted steel structure and external plastic finish equipped with 4 drawers, one lateral waste container, one extra lateral table, I.V. stand, defibrillator holder (plexiglass tray), oxygen holder up to 5 litres (back), 2 antistatic rubber castors.

- 27479 EMERGENCY TROLLEY - small 67x64xh 100 cm
- 27471 DIVIDER KIT for 27479 (drawer 45 cm)
- 27482 EMERGENCY TROLLEY - standard 82x64xh 100 cm
- 27472 DIVIDER KIT for 27482 (drawer 60 cm)

DISPOSABLE SEALS

- 27473 DISPOSABLE SEALS - box of 100
- 27474 DISPOSABLE NUMBERED SEALS - box of 100



EMERGENCY STANDARD

Transparent cardiac board

3 drawers
60x48x13 cm

1 drawer
60x48x26 cm

Built in perimetral protection



KS MULTIFUNCTIONAL TROLLEYS

MULTIFUNCTIONAL TROLLEYS: BASIC, DRESSING, EMERGENCY

Professional trolleys in 2 sizes (small and standard) and 3 models (Basic, Dressing and Emergency).

- antimicrobial epoxy painted body with seal lock (Emergency) or key lock (Basic and Dressing)
- top surface with 4-sided rim
- top surface with built-in compartment
- ball-bearing full-extension sliding drawer with self-closing system

- built-in handle
- 4 swivelling castors Ø 125 mm - 2 antistatic (only 45688/9) and with brake
- lateral waste container 15 l with lid and catheter holder (Dressing and Basic only)
- size: small 760x714xh 1,022 mm
standard 911x704xh 1,075 mm

Lateral side with waste container 15 l with lid and catheter holder



Dispenser with pole including 10 tilting bins



Back with large oxygen tank compartment and stainless steel holding rail with hooks

Lateral side with waste containers 15 l with lid



Writing surface

Lateral container unit with 4 supply trays



Writing surface

Lateral container unit with 4 supply trays



- 45680 BASIC TROLLEY - small
- 45681 BASIC TROLLEY - standard

- 45684 DRESSING TROLLEY - small
 - 45685 DRESSING TROLLEY - standard
- Dressing trolley is supplied with upper dispenser (10 tilting bins).

- 45688 EMERGENCY TROLLEY - small
 - 45689 EMERGENCY TROLLEY - standard
- Emergency trolley is supplied with rotating defibrillator/monitor tray, height adjustable I.V. pole with 2 hooks.

AURION MULTIFUNCTIONAL TROLLEYS - TOP QUALITY

AURION TROLLEYS

A multifunctional and revolutionary line of carts with innovative design, superior quality and complete accessories.

Made in Baydur® polyurethane

Baydur® Polyurethane is a high performance material that combines the best characteristics of plastics and metals. Light, sturdy, high resistance to scratching and impact. Resistant to UV rays. Chemical inert, doesn't react to acids, organic and inorganic, alkali and solvents (DIN 68861/1).

Fire resistant, self-extinguishing (Class I, UL94 V-O). Non-toxic, in case of combustion it doesn't produce dioxin.

Well-designed

The Aurion trolleys are ergonomic, modular, highly customizable and upgradable over the years. The handles are moulded and integrated into the body as well as the worktop that has large surface and perimetrical anti-drip containing rim. Every drawer is equipped with a label holder.

Easy to move

Lightweight structure combined with the high quality non-marking and anti corrosion castors. Every wheel is mounted on ball bearings with sealed lubrication (2 per wheel), 3 with brake, 1 antistatic.

Hygienic and safe

The smoothly shaped design, without edges, guarantees safety to the user and avoids dirty and bacterial accumulation points. Easy to clean and disinfect also with aggressive detergents.

Safe and secure

All-around soft rubber bumper help to avoid damages to hospital staff, patients, objects or to the trolley itself. Central locking device with key (45740-45746) or with seal (45750-45751). Size 775x710xh 920 mm



- 45751 AURION EMERGENCY TROLLEY - dark blue - 5 drawers
- 45750 AURION EMERGENCY TROLLEY - red - 4 drawers with IV stand, defibrillator tray, suction unit shelf (45751 only), CPR massage board, electric plug (45751 only).

- 45755 AURION AMAGNETIC TROLLEY - yellow - 5 drawers with amagnetic wheels, without locking system



- 45740 AURION THERAPY TROLLEY - green - 4 drawers
- 45741 AURION THERAPY TROLLEY - light blue - 5 drawers with IV stand (45751 only), upper drawers, bin (45741 only)

- 45744 AURION DRESSING TROLLEY - blue - 5 drawers
- 45746 AURION MONODOSE TROLLEY - brown - 2 drawers + 2 monodose cassettes (10 small drawers each)

MULTIFUNCTIONAL AND EMERGENCY KARTS

MULTIFUNCTIONAL KARTS

- High quality aluminium multifunctional and emergency carts with superior features.
- work-top in high performance copolymer, with perimetric edge for liquid containment
 - extruded aluminium frame, with superficial silver antioxidant treatment offering more lightness, resistance and reliability
 - ergonomic stainless steel handles, fitted on both sides for easy handling
 - drawer structure built in steel sheets, epoxy powder coated
 - full pull-out sliding drawers

- interchangeable drawer position
- aluminium drawer handle with "hook/unhook" system to prevent accidental opening of drawers



Centralized locking system with key



Small drawer
Medium drawer
Large drawer

- 45660**
+ **45661**
• **45660 COMPACT KART** - 5 drawers - blue
Size: 634x605xh 975 mm
• **45661 UPPER DRAWERS (9+5)** - blue for 45660
• **45662 MEDIUM KART** - 5 drawers - blue
Size: 804x616xh 975 mm
• **45663 UPPER DRAWERS' (9+5)** - blue for 45662
*Included support for glove box
• **45677 PARTITION KIT** for compact kart drawers h2/h3



45677

- high drawers capacity: 20 kg (35 kg for drawer h-200-283 mm)
- centralized locking system with front key or single use seals (emergency karts only)
- 6 integrated side pockets (3+3) to hold bottles or small items
- swivelling wheels Ø 125 mm (two with brake) in thermoplastic rubber with threadguards, hub on precision ball bearings.

TECHNICAL SPECIFICATIONS

Frame size:	COMPACT: 654x605xh 975 mm	MEDIUM: 804x616xh 975 mm
Drawer size Compact/Medium:	Front width/height	Inner sizes
small	h1= 1/10 490/640xh 64 mm	432/582x448xh 58 mm
medium	h2= 2/10 490/640xh 137 mm	432/582x448xh 131 mm
large	h3= 3/10 490/640xh 210 mm	432/582x448xh 204 mm
folder holders	h4= 4/10 490/640xh 283 mm	432/582x448xh 270 mm



Defibrillator holder shelf with strap

Infusion stand holder has safety anti-release system and 2 kg capacity per hook. Made in chrome-plated steel.

- **45665 EMERGENCY COMPACT KART** - 5 drawers - red
- **45666 EMERGENCY COMPACT KART** - 4 drawers - orange
- Size: 654x605xh 975 mm
- **45667 EMERGENCY MEDIUM KART** - 5 drawers - red
- **45668 EMERGENCY MEDIUM KART** - 4 drawers - orange
- Size: 804x616xh 975 mm
- Supplied with infusion stand holder 4 hooks, Ø 120-150 mm
- defibrillator holder tray, cylinder holder (double for 45667/8) and CPR board (only 45666/8).
- **27473 DISPOSABLE SEALS** - box of 100
- **27474 DISPOSABLE NUMBERED SEALS** - box of 100



45666



Slim LED X-ray illuminator viewing area 42x36 cm. See other specifications at page 144, code 44700.



Folder holders

- **45671 VIEWER KART**
Compact kart with slim LED viewer, 2 small drawers and 2 folder holders.
- **45672 VIEWER KART 2**
Compact kart with slim LED viewer, 2 small and 1 medium drawers, 10 compartments for folders (44x48xh 43,8 cm).



Upper drawers with 14 compartments (9+5)

- **45656 PEDIATRIC KART**
Pediatric compact kart with 2 medium and 2 large drawers.
- **45657 UPPER DRAWERS (9+5)**



- **45674 MULTIPURPOSE KART**
Compact kart with 2 small drawers and 2 folder holders.
- **45675 UPPER DRAWERS (9+5)**
- **45678 HANGING FILE FOLDERS***

• **45650 PERSONALIZED KART: CONFIGURATE YOUR KART SELECTING COLOUR, DRAWERS AND MODEL** - available in 45 days

Available drawers

Small 1/10 h	Medium 2/10 h	Large 3/10 h	Folder holder 4/10 h
Red RAL3020	Orange RAL2004	Turquoise RAL5018	Blue RAL5010

Available colours

Ceil blue RAL5012	Green RAL6018	Yellow RAL1021
----------------------	------------------	-------------------

* Box of 25 hanging file folders 365 x 240 mm

You can choose your drawers considering:
- interchangeable position of drawers
- sum of selected drawers should be 10/10 h

PAINTED OR STAINLESS STEEL MODULAR TROLLEYS SYSTEM



MODULAR TROLLEYS SYSTEM

Modular trolleys made of painted steel or stainless steel, one-piece structure, with wide technopolymer plastic worktop with borders on 3 sides to be cleaned easily, no sharp corners, ergonomic tubular push-handle.

Different drawers (small-yellow, medium-blue, large-red), depending on model, with epoxy painted panels and

integrated handle grip, silent sliding with end-run block. Possibility to remove the drawers from the guides for an easy cleaning and disinfection. Central lock key. Overall bumpers and 4 antistatic 125 mm castors, 2 with brakes. Size: 67x63x104 cm. Weight: 53 kg. Made in Italy.

Personalization for minimum 10 pcs: drawers in your colour.

Painted	Stainless steel	TROLLEYS
45600	45620	Trolley with 7 small drawers
45601	45621	Trolley with 1 small, 3 medium drawers
45602	45622	Trolley with 2 small, 1 medium, 1 large drawers
45603	45623	Trolley with 1 small drawer, 1 compartment with shelf
45604	45624	Trolley with 2 medium, 1 large drawer

ACCESSORIES FOR ALL MODULAR SYSTEM TROLLEYS

45640	IV stand
45641	Upper drawers (5 medium + 4 large)
45644	Partition h 4 cm for yellow drawer (49x48x10 cm)
45645	Partition h 14 cm for blue drawer (49x48x20 cm)
45646	Partition h 20 cm for red drawer (49x48x30 cm)



WASH-BASIN - PUMP

45410 WASH-BASIN PUMP SYSTEM - white

Automatic wash-basin with round bowl in satin stainless steel, non-connected to the water mains. The system ensures the availability of water when it is expensive or impossible to lay drain-pipes in the walls or floors.



Dimensions:
47x54xh 86 cm

It only requires a 230V power socket: the low voltage transformer (12V) drives a pump for supplying water by a simple pressure of the foot on the base.

Equipped with 2x20 litre tanks for water supply and drain

UTILITY TROLLEY



45595

Blue Avio RAL 5010 available in stock

45595 UTILITY TROLLEY - blue avio 45597 UTILITY TROLLEY - other colours*

RAL	RAL	RAL	RAL	RAL
5010	2003	6019	1013	3020

*Available in 30 days. Minimum order 5 pcs.

Smart and strong steel structure painted with epoxy powder. Technopolymer plastic one-piece top with border, without sharp corners, with compartment for accessories. Ergonomic push handle.

3 medium drawers 45.1x48.5xh 15 cm and 1 large drawer 45x49.5xh 22.5 cm with silent sliding and end-run block. Central lock key. Size: 60x50xh 100 cm Overall bumpers and 4 antistatic 125 mm swivelling castors, 2 with brake. Made in Italy.



45597 Utility trolleys other colours available in 30 days

MULTI-PURPOSE WALL UNITS

Multi-purpose wall unit to organize dispensers of disposable products. All components and slots are modular and can be organized to match professional user needs. Available in 2 sizes: standard (103x20xh 40 cm) and large (153x20xh 40 cm) and 8 colours. Melamine particle board door with vertical opening. Supplied with automatic soap dispenser, cups dispenser and 5 (standard) or 7 (large) slots.

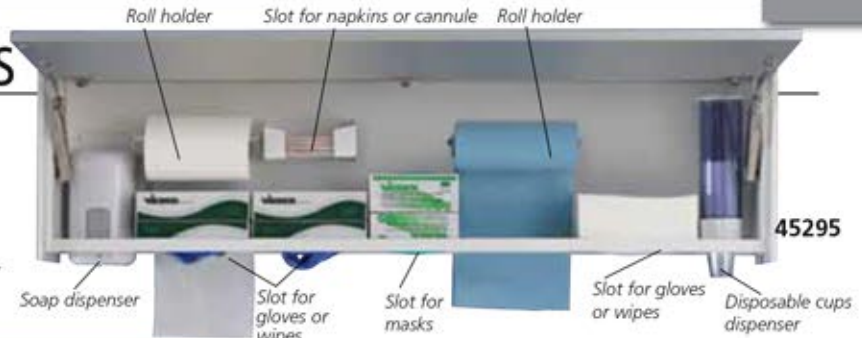

STANDARD ACCESSORIES	45290	45295	45293	45298
Dispenser for disposable cups	1	1		
Automatic soap dispenser	1	1		
Slot for gloves or wipes	2	3		
Slot for masks	1	1		
Slot for napkins or cannula	-	1		
Roll holder	2	2		

MULTIFUNCTIONAL WALL UNITS							
Model	white	light blue	grey	oyster white	yellow	blue	green orange
Standard	45290	← 45293*			→ 45295*		
Large	45295	← 45298*			→		

*Available in 60 days, please specify colour with order

GIMA WORKTOPS AND MOBILE UNITS



The key principle in the design of this system is a total separation of the work surface (fixed) from the mobile units. The worktop set in a fixed position allows to bring together all electric and electronic wiring, as well as plumbing and water-pipes into a single location. The work surface remains free to place instruments and electric appliances, can incorporate a sink and serves as a desk. All mobile containers have wheels and are the dynamic part of the system. They can be easily placed under the work surface, or moved by the user wherever needed in the working environment. Units are interchangeable and can be freely moved between rooms. Work surfaces are made in a waterproof material covered with a high-quality melamine particle board, which ensures long durability, scratch and wear resistance. A range of 4 containers, in 8 different colours with ergonomic full-length handles. Made in Italy.

code	STANDARD WORKTOPS - WHITE
45300	Worktop 180 cm - right washbasin
45301	Worktop 180 cm - left washbasin
45302	Worktop 180 cm - without washbasin
45303	Worktop 232 cm - right washbasin
45304	Worktop 232 cm - left washbasin
45305	Worktop 232 cm - without washbasin

code	ACCESSORIES
45401	Tray 33x43.5xh6.5 cm
45402	3-compartment tray 33x43.5xh6.5 cm
45403	11-compartment tray 33x43.5xh6.5 cm
45405	Chromed mixer tap



MOBILE UNITS							
Model	white	light blue	grey	oyster white	yellow	blue	green orange
S1	45350	45360	← 45390*			→	
S5	45353	45363	← 45393*			→	
S9	45356	45366	← 45396*			→	
S10	45357	45367	← 45397*			→	

*Available in 60 days, please specify colour with order

1 OR 3 ENGINES GYNAECOLOGICAL CHAIRS AND STOOLS

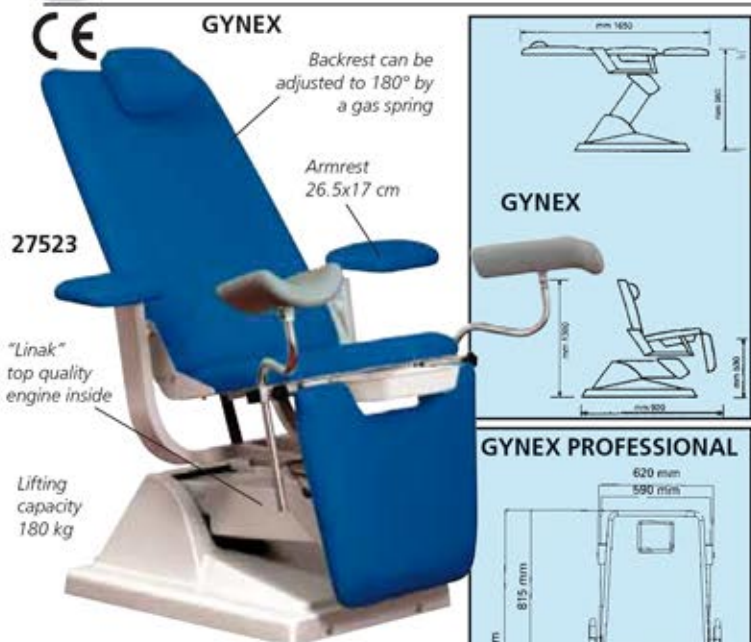

GYNEX - GYNAECOLOGICAL CHAIR
GYNEX: a chair offering a unique combination of functional, aesthetic and working characteristic. Thanks to its self-balancing seat and backrest, GYNEX can be adjusted to any build for the greatest patient comfort. The chair is provided with an electromechanical lifting device, having a power supply at 24 V. The electric actuators enable the movement up and down from 57 cm off the floor ("0" position) up to a maximum of 96 cm. The backrest is supplied with adjustable headrest and paper roll holder. The legrest can be independently adjusted and it has an automatic-locking device. The chair can be flattened to a bed position for examination activity, the armrest can be removed and independently oriented. The electric control of the chair for upright position is operated by means of a foot pedal. Made in Italy.

GYNEX PROFESSIONAL - GYNAECOLOGICAL CHAIR
Gynex professional chair offers functionality, aesthetics, ergonomics. It can satisfy all patient and user needs for a professional gynaecologic visit. Gynex professional is provided with versatile accessories: back paper-roll dispenser, metal basin, leg-supports. 3 engines allow, in addition to lifting, electric backrest and legrest movements. The combined movement of backrest and seat by means of self-balancing system (operated by a silent low tension actuator of 2,500 N) grants maximum comfort to the patient. The padded and pelted armrests allow a relaxing protecting sitting position, armrests are individually revolving and removable. Backrest is provided with removable height-adjustable headrest. The wide and soft backrest has independent adjustment movement through silent low tension actuator. This chair is moved by a silent low tension engine which allows a vertical excursion of 40 cm from zero position. The electrical drives are controlled by an ergonomic hand switch control, connected to the chair by a cable. Gynex professional can be easily transformed into an examination bed (horizontal position). Made in Italy.

TECHNICAL SPECIFICATIONS

	GYNEX	GYNEX PROFESSIONAL
Power supply tension:	230V - 50 Hz (110V - 60 Hz on request)	24 V
Motor tension:	24 V	24 V
Lifting motor push:	6,000 N	6,000 N
Backrest push:	800 N (gas spring)	2,500 N (motor)
Legrest motor push:	-	2,500 N
Lifting capacity:	180 kg	180 kg
Maximum power:	90 VA	90 VA
Fuses protection:	1.6 A	1.6 A

GYNEX CHAIRS AND STOOLS

	Light blue Parigi	Green Toronto	Blue Chicago	Orange Rotterdam	Metal Apricot	Metal Sea blue	Colour on request	
Gynex professional	27514	27512**	27513	27512**	27515	27512**	27512**	
Gynex	27521	27522	27523	27524	27525	27526	27520**	
Stool with ring	27531	27532	27533	27534	27535	27536	27530**	
Stool without ring	27527	27528**						

** Available in 60 days, specify colour with order

COLOUR ON REQUEST: CLASSIC COLOURS

White Helsinki	Beige Roma	Beige Tunisi	Brown Perugia	Yellow Parma	Orange Praga	Red Mosca	Pink Malaga	Bordeaux Bangkok
Green New Delhi	Green David	Green Melbourne	Green Irlanda	Green Honolulu	Green Caracas	Violet Nizza	Violet Ankara	Light blue Palm beach
Blue Berna	Blue Baltico	Blue Anversa	Grey Oslo	Grey Amburgo	Grey Londra	Black Odessa		

COLOUR ON REQUEST: METALLIC COLOURS

Metal Ice	Metal Silver	Metal Bronze	Metal Gold	Metal Lemon	Metal Red	Metal Sky Blue	Metal Blue	Metal Dust Grey
-----------	--------------	--------------	------------	-------------	-----------	----------------	------------	-----------------



STANDARD ACCESSORIES

	GYNEX	GYNEX PROFESSIONAL
Poliuretane leg-rest	•	•
Padded leg-rest (colour coordinated)	•	•
Paper-roll holder	•	•
Basin	• (plastic)	• (metal)
Remote control	•	•

STOOL - with or without ring

For professional use, completely built in stainless steel, 360° pivoting self-braking castors, rubber-tyred. Height can be comfortably adjusted by means of a gas pump; back-rest is 180° revolving and depth-adjustable. Seat is balanced density padded and Peltex-lined. Made in Italy.



GYNAECOLOGICAL AND DELIVERY BEDS



Size: 180x55xh 80 cm
Seat size: 55x55 cm
Delivered in kit form.

27501

Standard leg holders



27503

Quality leg holders



27504

Standard and quality leg holders have 360° rotation



Size: 180x55xh 80 cm.
Delivered in kit form.

27510

- 27500 DELUXE GYN BED - quality leg holders
 - 27501 GYNAECOLOGY BED - standard leg holders
- Strong chrome-plated structure. Rectangular steel tube. Adjustable head and leg sections. Simulated leather, black colour, washable upholstery, self extinguishing. Load: 100 kg. Complete with s/s bowl Ø 31 cm and leg-holders. Made in Italy.
- 26586 S/S BOWL Ø 31 cm - spare

- 27510 DELUXE DELIVERY BED - quality leg holders
- Same as 27500, but with three sections with independent controls and Trendelenburg position. Load: 120 kg.
- 27503 STANDARD LEG HOLDERS - couple - spare
 - 27504 QUALITY LEG HOLDERS - couple - spare
- Kit leg holders includes 2 leg-holders and arms.
- 27418 COUCH ROLL HOLDER

3-SECTION MULTIFUNCTIONAL AND GYNAECOLOGICAL BEDS



LOAD 150 KG

27505

Fully adjustable standard leg holder, turnable 360° (27508)

Seat: 50x60 cm

Size: 181x60xh 83 cm
Delivered in kit form.

- 27502 3-SECTION MULTIFUNCTIONAL BED - blue
 - 27505 3-SECTION GYNAECOLOGICAL BED - blue
- Strong and stylish structure in oval tube 50x25 mm, painted with epossidic powder, metallic grey colour. The three sections top has high density padding, covered with washable, fire proof, leatherette material Class 1 IM. Back-rest and leg-rest section are fully adjustable by self mechanical system. Gynaecological bed is supplied with 2 foam padded leg holders and stainless steel bowl Ø 32 cm. Maximum load: 150 kg - Weight: 36 kg. Made in Italy.



27502

Size: 185x60xh 85 cm

Delivered in kit form

Seat: 62x60 cm

- 27508 STANDARD LEG HOLDER - couple - spare
 - 27509 QUALITY LEG HOLDER - couple
- Kit leg holder, includes 2 leg-holders and arms.
- 27511 COUCH ROLL HOLDER for 27502-5
 - 27919 DESK with 2 drawers - 130x71xh 80 cm
- Strong structure in oval tube 40x20 painted with epossidic powder, metal grey colour. White work top with rubber edge and round corner.
- 27979 FOOT STOOL - 2 steps



27919



27979



27538

3-SECTION DELIVERY BED WITH TRENDELENBURG

- 27538 3-SECTION DELIVERY BED - with Trendelenburg
- structure made of epoxy painted oval steel tube
 - three sections with independent control and Trendelenburg position
 - padding made of high density polyurethane foam, fireproof Class 1 IM
 - covering made of washable, plastic material (leatherette) fireproof Class 1 IM
 - adjustable rubber feet
- Size: 181x60xh 80 cm
Carton size: 75x20xh 196 cm.
Maximum load: 150 kg.
Net weight: 43 kg.
- Supplied with a pair of height-adjustable, padded, anatomic leg-holders, a couple of shoulder rests, handgrips, a paper roll holder and a stainless steel basin Ø 32 cm. Delivered in kit form. Made in Italy.
- 27509 QUALITY LEG HOLDER - couple

DONOR ARMCHAIR

- 27557 DONOR ARMCHAIR - blue - mechanical
- 27563 DONOR ARMCHAIR - blue - electrical
- 27567 DONOR ARMCHAIR WITH WHEELS - white

Strong and stylish armchair with structure made with oval, round and square metal section tubing (legs oval tubing 50x25x1.5; central frame square tubing 30x30x1.5, cushions round tubing 20x1.5 diam.). Structure fully coated with white epoxy powder. High density polyurethane foam platform with wooden base covered by leatherette upholstery.

Both materials are flame resistant Class 1 IM. Synchronized adjustment of the two cushions by a gas spring, cylinder/piston, (27557, 27567) or by a linear actuator (27563) with a push-button panel, allow a quick moving into TR/RTR position. The backrest inclination ranges from +60° to -5° in Trendelenburg position, leg rest from -80° to +5°.

The arm-rests can be height adjusted and are reclinable. When removed, they can be rotated up to 180°.

Four adjustable feet ensure maximum stability (27557 and 27563) or 4 castors, 2 with directional brake (27567) ensure mobility. Load: 150 kg. Size: 175x55xh 51 cm. Made in Italy.

- 27553 IV STAND
- 27556 COUCH ROLL HOLDER



27557



27557

White ral colour
9003 structure,
minimum thickness
70/80 micron.
Glossy finish.



WITH WHEELS



27567



27563

ELECTRICAL



DONOR WHEELCHAIR

- 27561 DONOR WHEELCHAIR

Donor wheelchair with structure made of epoxy painted oval and round steel tube.

Backrest adjustable by gas pump. Padded leg rest manually adjustable.

Metal footrest extractable. Armrest with articulations, manually adjustable in height.

Padding made of high-density polyurethane foam, fireproof Class 1 IM. Covering made of washable, plastic material (leatherette), fireproof Class 1 IM.

Back push handle.

Mattress overall size: 166x55 cm. Carton size: 185x67xh 58 cm

Four wheels Ø 100 mm, 2 directional and 2 with brake.

Net weight: 53 kg. Gross weight: 55 kg. Maximum load: 150 kg.

Supplied with blanket tray with belts to fix oxygen bottle, IV stand and chart holder support. Made in Italy.



Chart holder support



27561

Blanket tray with belts to fix oxygen bottle (bottle not included)

HEIGHT ADJUSTABLE GYNAECOLOGICAL BED

- 27506 HEIGHT ADJUSTABLE GYN BED - green
- 27507 HEIGHT ADJUSTABLE GYN BED - blue
- 27496 HEIGHT ADJUSTABLE GYN BED - any colour*

*Available in 20 days, see below available colours

Strong and solid structure in oval tube 50x25x2 mm painted with epoxy powder, white colour.

The three sections top has high density padding, covered with washable, fire proof, leatherette material class 1 IM.

Full adjustable

Height, up to 95 cm, is adjustable by electric engine (6000 N power) with foot control, head section is adjusted by a gas cylinder (400 N power), central section by a gas cylinder (600 N power) up to 65°. This gyn bed is supplied with 2 quality foam leg holders, stainless steel tray and couch roll holder.

Maximum load: 150 kg. Weight: 70 kg. Made in Italy.

- 27509 QUALITY LEG HOLDER - couple - spare

Kit leg holder includes 2 leg holder and arms.

Suitable for 27496, 27505, 27506, 27507.

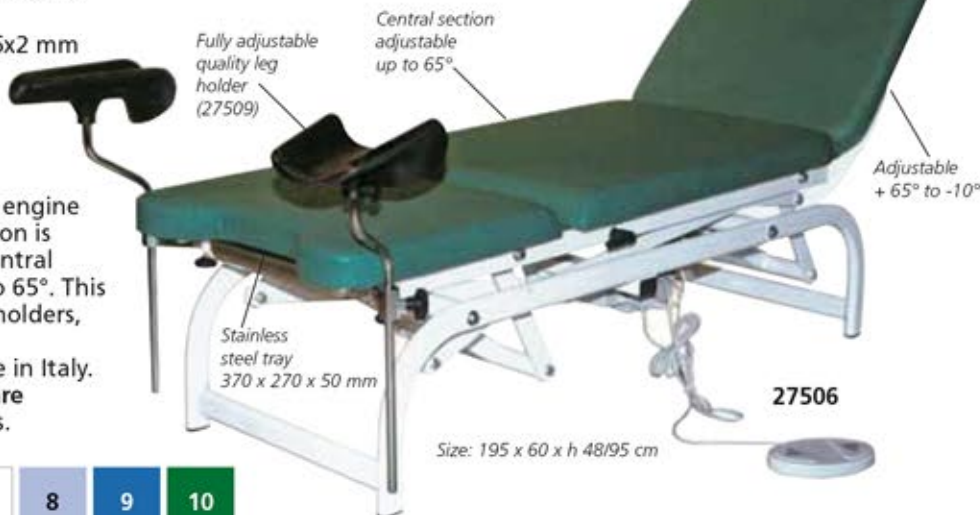

27506

Size: 195 x 60 x h 48/95 cm

Fully adjustable quality leg holder (27509)

Central section adjustable up to 65°

Adjustable + 65° to -10°

Stainless steel tray 370 x 270 x 50 mm



ENT CHAIRS

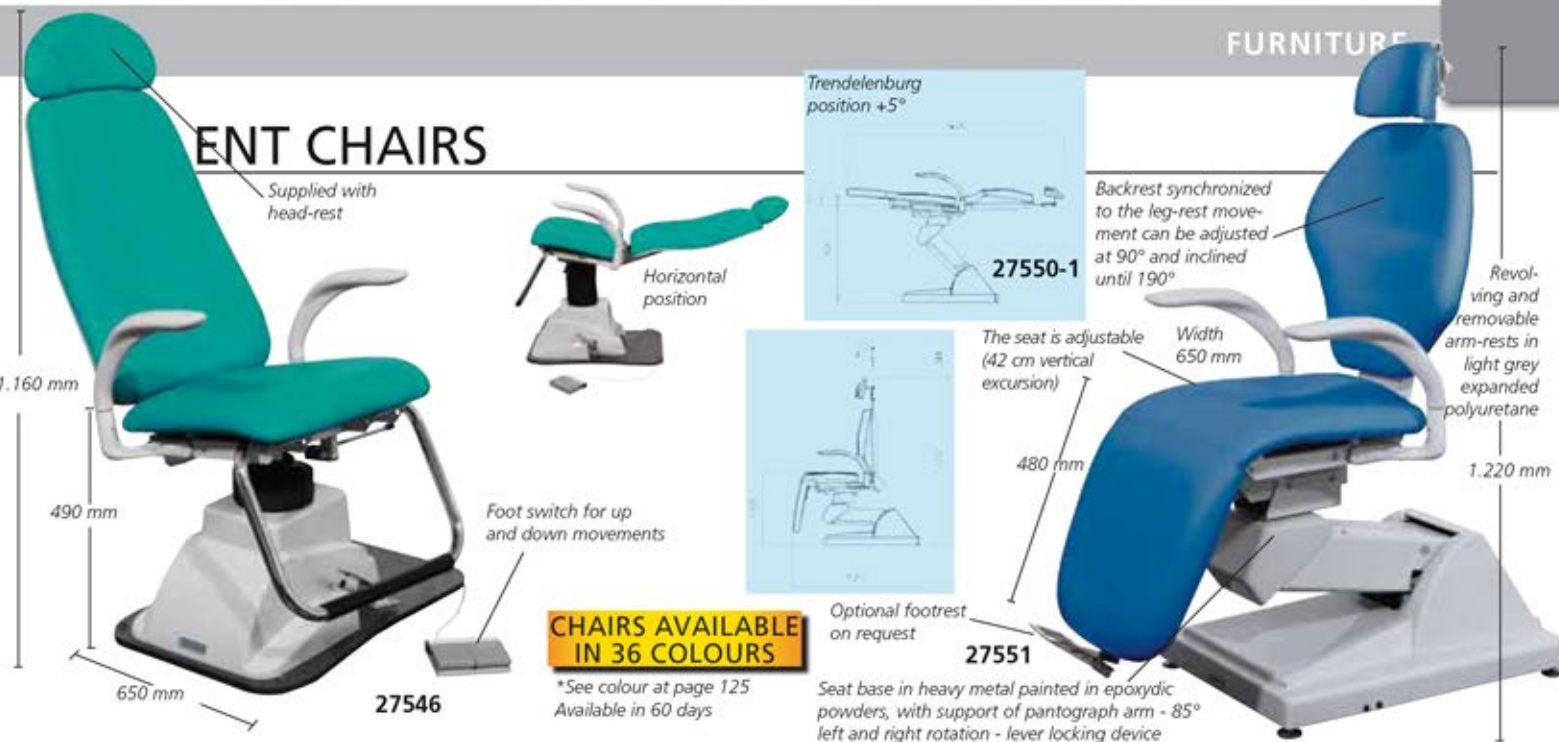

• 27545 OTO/PV ENT CHAIR with head support - colour on request*
 • 27546 OTO/PV ENT CHAIR with head support - green Melbourne
 • 27547 OTO/PV ENT CHAIR with head support - sky blue Parigi
 Patient chair with Peltex-lined seat and backrest. Electric up and down movements by silent engine controlled through foot switch. Back-rest can be adjusted up to 180° by a gas spring. Chair rotates 360° and is provided with a rotation locking device placed at the bottom. Power: 230 V - 50 Hz (Available 110 V - 60 Hz). Made in Italy.

• 27550 OTOPEX ENT CHAIR with head support - colour on request*
 • 27551 OTOPEX ENT CHAIR with head support - blue Chicago
 • 27552 OTOPEX ENT CHAIR with head support - green Toronto
 ENT chair designed also for ambulatory operations. Moved by very silent electrical engines operated by joystick foot-control. Also provided with button to re-set to previously selected working position. Upholstery made of simulated leather, high density undeformable foam padding (50 kg/cm³). Seat and leg-rest are joined in a single piece. Power: 230 V - 50 Hz (Available 110 V - 60 Hz). Made in Italy.

ENT CABINETS

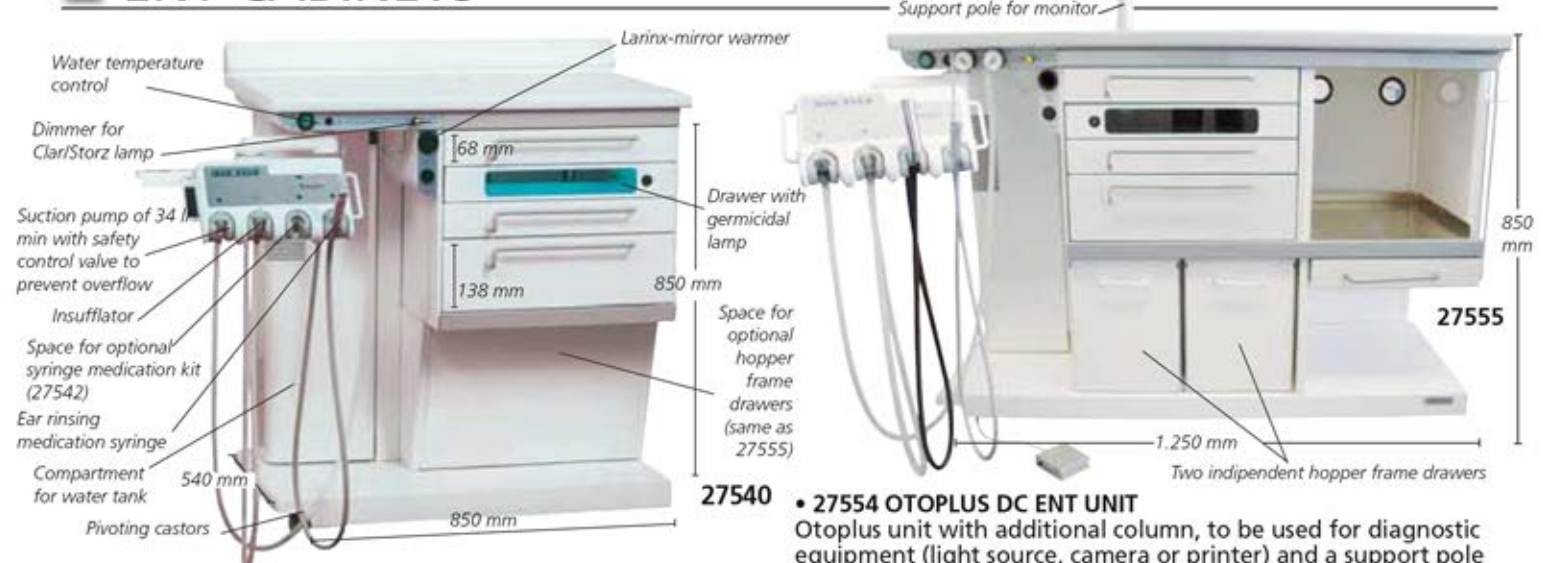

• 27540 OTOPLUS - ENT UNIT
 The E.N.T. unit has rubber pivoting castors, a working surface made of scratch-proof rolled sections, 2 small and one large drawers provided of removable internal partitions, one drawer with inside germicidal lamps to keep instrument sterilization. Otoplus is provided with a silent suction pump of 34 l/min, with power supply complete with dim adjustment device for Clar/Storz lamp, larynx-mirror warmer, twin-cylinder dry compressor for tubal insufflation, 2-litres distilled water tank with acoustic signal for reserve level. The articulated arm with instrument holding tray is complete with terminal suction cannula and terminal insufflation cannula, ear rinsing syringe with automatic water temperature control, (a microprocessor keeps temperature at a constant level of 37 °C). Power 230 V - 50 Hz (Available 110 V - 60 Hz). Made in Italy.
 • 27539 OTOPLUS COMPLETE
 Same as code 27540 with included vasister drawers (code 27541) and endoscope support (code 27543).

• 27554 OTOPLUS DC ENT UNIT
 Otoplus unit with additional column, to be used for diagnostic equipment (light source, camera or printer) and a support pole for monitor.
 • 27555 OTOPLUS DC ENT UNIT - complete
 Same as code 27554 with included hopper frame drawers (code 27541) and endoscope support (code 27543)
 • 27541 HOPPER FRAME DRAWERS - 2 independent drawers
 • 27543 ENDOSCOPE SUPPORT - 2 transparent plastic tubes 1 tube 50 cm long and 1 tube 25 cm long both closed at the bottom.
 • 27542 SYRINGE MEDICATION KIT composed of 1 syringe, 2 atomizers (1 for liquid and 1 for powder) and 3 ampoules in dark glass. To be ordered with ENT unit.
 • 27544 LED LIGHT SOURCE
 Makes cold white light (5500 °K, 200 lumen) for endoscopy use. It can be connected to endoscopes without need of F.O. cable. Handle connect directly to rigid endoscopes (Storz connection).
 LCD display: 12.8x6.4 cm
 Size: 30x25x12 cm



HYDRA PODOLOGY CHAIR - MADE IN ITALY

- 28033 HYDRA PODOLOGY CHAIR - green David
- 28035 HYDRA PODOLOGY CHAIR - any colour*

Functional and compact podiatry chair. The up/down movement, activated by a foot switch is synchronized to the seat inclination in order to easily lift the patient foot to the optimal working position, allowing the operator to keep the correct posture during the whole therapy. One silent electric actuator activates the up/down movement allowing a vertical lift range of 40 cm (min height

55 cm/max height 95 cm). Combined to the seat inclination movements, it permits the heel rest to reach the height of 120 cm from the floor. The backrest is manually adjustable to 180° through a powerful gas spring. The upholstered ergonomic parts grant high comfort to the patient. The double legrests swivel horizontally and the extendable heel rest holds the foot in various working positions. Comfortable padded arm rests. Lifting capacity: 180 kg. Chair's weight: 80 kg. Power supply: 230 V - 50/60 Hz.



28033

COLOUR ON REQUEST: CLASSIC COLOURS*							
White Helsinki	Beige Roma	Beige Tunisi	Brown Perugia	Yellow Parma	Orange Praga	Red Mosca	Pink Malaga
Bordeaux Bangkok	Green New Delhi	Green Melbourne	Green Irlanda	Green Honolulu	Green Caracas	Orange Rotterdam	Violet Nizza
Violet Ankara	Light blue Palm beach	Blue Berna	Blue Baltico	Blue Anversa	Grey Oslo	Grey Amburgo	Grey Londra
Black Odessa	Light blue Parigi	Green Toronto	Blue Chicago				

COLOUR ON REQUEST: METALLIC COLOURS*							
Metal Ice	Metal Silver	Metal Bronze	Metal Gold	Metal Lemon	Metal Red	Metal Sky Blue	Metal Blue
Metal Dust Grey	Metal Apricot	Metal Sea blue					

*Available in 60 days, specify colour with order

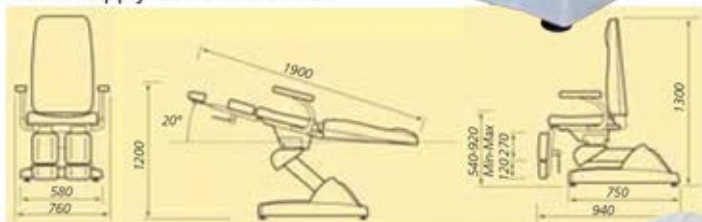

PODOLOGY CHAIRS



45232

- 28025 ELECTRIC PODOLOGY CHAIR - 3 motors - blue
- Electrically controlled chair to independently adjust height, backrest and seat inclination, by foot switch or push button panel. Head rest can be inclined, arm rests are movable. Operating power: 220-240 V - 50/60 Hz. Size: 186x56x58/89 cm. Maximum load: 170 kg. Net/Gross Weight: 83/96 kg
- 45232 STOOL - blue
- 45242 STOOL WITH BACKREST - blue



28020

- 28020 PODOLOGY CHAIR - mechanical - white
- This chair can move up and down and rotate. Backrest and footrests are adjustable. Heavy round base provides maximum stability. Size: 180x80xh 51/65 cm. Maximum load: 170 kg. Weight: 41 kg
- 45231 STOOL - white
- 45241 STOOL WITH BACKREST - white

GAMMA/PODOLOGICAL CABINETS - MADE IN ITALY

- 28030 GAMMA1 CABINET - 61x45xh 77 cm - small
 - 28031 GAMMA3 CABINET - 108x45xh 77 cm - large
- Practical service cabinet, equipped with tabletop in scratch-resistant wood, drawers and doors, specifically designed to keep tools and accessories sterile. Base with castors to facilitate movement. Supplied with connections to the mains: germicide compartment, lampholder and other electric sockets. Power supply: 220 V - 50/60 Hz.

	SIZES				Germicide compartment	Large compartment
	Cabinet		Table top			
Length:	28030 61 cm	28031 108 cm	28030 61 cm	28031 108 cm	28 cm	28 cm
Width:	45 cm	45 cm	42 cm	42 cm	38 cm	28 cm
Height:	77 cm	77 cm			4 cm	15 cm



28030

28031

ELECTRIC CHAIRS WITH FOOT CONTROL - 3 MOTORS



45244

28040

- 28040 CLEOPATRA ELECTRIC CHAIR - 3 motors - beige
Electrically controlled 3 motors chair to adjust separately height, backrest and seat inclination by foot switch or push button panel. Footrest adjustable by gas lift pump. Reversible arms and adjustable headrest. Operating power: 220-240 V - 50/60 Hz.
- 45234 STOOL - beige
- 45244 STOOL with backrest - beige



45233

28045

- 28045 NEFERTITI ELECTRIC CHAIR - 3 motors - green
Electrical chair with very stable structure and high comfort. Specially designed to optimize the workspace due to 240° rotation. 3 motors control height, backrest and seat inclination by foot switch or push button panel. Footrest adjustable by gas lift pump, reversible arms and adjustable headrest. Operating power: 220-240 V - 50/60 Hz.
- 45233 STOOL - green
- 45243 STOOL with backrest - green

PROFESSIONAL MECHANICAL AND ELECTRIC CHAIR

Size: 185x85xh 56-75 cm
Net weight: 72 kg
Max load: 170 kg



45241

- 28005 LUXOR CHAIR - mechanical - white
- 28006 LUXOR CHAIR - mechanical - blue
Chair can move up and down and rotate 360°. Backrest and footrest are adjustable.

28005/28006

STOOLS

- 45231 STOOL - white
- 45232 STOOL - blue

STOOLS with backrest

- 45241 STOOL - white
- 45242 STOOL - blue
See page 141.

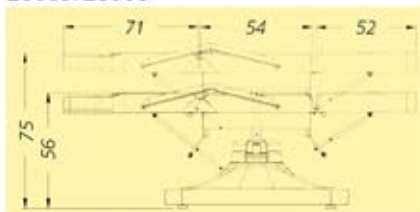

Size: 186x88xh 71-96 cm
Net weight: 75 kg
Max load: 170 kg



45232

28011

- 28010 LUXOR ELECTRONIC CHAIR - 3 motors - white
- 28011 LUXOR ELECTRONIC CHAIR - 3 motors - blue
Electrically controlled chair to adjust separately height, backrest or footrest. Hand and foot control. Armrest and headrest are flexible. Operating power: 220-240 V - 50/60 Hz. Available on request 100-120 V.

28010



GIMA ADJUSTABLE HEIGHT ELECTRIC TABLE

- 27632 GIMA TREATMENT TABLE - any colour**
- 27633 GIMA TREATMENT TABLE - blue
- 27634 GIMA TREATMENT TABLE - cream
- 27628 GIMA TREATMENT TABLE - green
- 27635 GIMA TREATMENT TABLE - black

AVAILABLE IN 6 COLOURS

Sturdy and highly stable examination and treatment table.

Adjustable height by electric foot switch. Fixed leg-section and manually adjustable head-section with mouth-nose hole. Fire proof padding. Lifting capacity: 140 kg. Length: 193 cm. Made in Italy.

STOOLS: matching stool at page 141.

- 27629 COUCH ROLL HOLDER
- 27630 MOUTH-NOSE HOLE PLUG - any colour**
- 27631 MOUTH-NOSE HOLE PLUG - blue
- 27620 MOUTH-NOSE HOLE PLUG - cream
- 27625 MOUTH-NOSE HOLE PLUG - green
- 27621 MOUTH-NOSE HOLE PLUG - black

** Available in 15 days

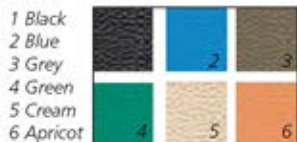

ELECTRIC OR HYDRAULIC HEIGHT-ADJUSTABLE TABLES



27587

Accessibility. The laterally open frame permits the access with patient lifting system or trolleys for electrotherapy equipment.

AVAILABLE IN 24 COLOURS

WIDTH 80 cm



27595

BRUXELLES TABLES - electric or hydraulic

Examination and treatment table with high stability. Electric height adjustment by a foot-switch (low tension 24 V) or manual by hydraulic piston. Features: one mobile section, gas-spring supported adjustment of the head-section (with mouth-nose hole) and fixed leg-section.

The large head-section can be adjusted positively and negatively and serves as back-rest. Safe working load 200 kg. Power 230 V - 50/60 Hz. Made in Italy.

TRENDELENBURG



27602

- 27602 THER TRENDELENBURG TABLE - electric - any colour**
- 27603 THER TRENDELENBURG TABLE - electric - blue (3)
- 27604 THER TRENDELENBURG TABLE - hydraulic - any colour**

Examination and treatment tables with electric height adjustment by a foot switch (low tension 24 V) or hydraulic height adjustment by a piston. Features: three mobile sections adjustable by gas spring. The table can easily assume the "flexion", "relax" and "trendelenburg" position even if the patient is lying on the table. The large head-section (with mouth-nose hole) can be adjusted positively and negatively. Chair position. Safe working load 200 kg. Power 230 V - 50/60 Hz. Supplied with mouth-nose hole plug. Made in Italy.

BRUXELLES TABLES	Standard 68 cm	Large 80 cm
Electric - any colour**	27587	27595
Electric - blue	27588	-
Hydraulic - any colour**	27589	27596

** Available in 30 days

code	ACCESSORIES FOR ALL TABLES
27590	Couch roll holder for rolls 50 to 63 cm
27591	Wheels set
27594	Mouth-nose hole plug - any colour** for 27587-9, 27595-6, 27582-4

** Available in 30 days



Wheels set - optional

Upholstery colour code



KING HEIGHT ADJUSTABLE EXAMINATION COUCH

- 27613 KING HEIGHT ADJUSTABLE EXAMINATION COUCH - blue - 9
- 27612 KING HEIGHT ADJUSTABLE EXAMINATION COUCH - any colour*

*available in 20 days, see below available colours

Height adjustable (48-95 cm) examination couch by electric actuator (Linak engine 6.000 N) controlled by foot switch with head section easily adjustable (to +60° and -10°) by a gas pump. Strong and stylish leg structure in oval tubing 50x25x2 mm, central frame in rectangular tubing 50x20x1.5 mm painted with RAL 9003 white epoxy powder. Minimum thickness 70/80 micron, glossy finish. High density polyurethane foam platform with wooden base covered by leatherette upholstery. Both materials are flame resistant Class 1 IM. Leatherette washable with the most common detergents. Couch roll holder included. Maximum load: 150 kg. Made in Italy.



Size: 190x60xh 48/95 cm
Weight: 70 kg



27613



VARIABLE HEIGHT EXAMINATION COUCH WITH TR/RTR

- 44510 LORD VARIABLE HEIGHT EXAMINATION COUCH - water green - 5
- 44516 LORD VARIABLE HEIGHT EXAMINATION COUCH - any colour*

*available in 20 days, see below available colours

Stable and sturdy examination couch made in high quality tubular for furniture. Very practical and user friendly. Height adjustable thanks to the two electrical columns that can move simultaneously or separately (allowing the Trendelenburg/Reverse Trendelenburg position) by a push-button panel.

Under the top frame, an ergonomic lever actions a gas spring that reclines the cushions. High density, rubber padded, fire retardant and Class 1 IM top, covered in coated fabric (vinyl, synthetic leather, flame retardant Class 1 IM).

It can be cleaned with common detergents.

Complies with: EU 93/42 CEE. Maximum load: 200 kg.

Supplied with mouth/nose hole plug, paper roll holder and 4 adjustable feet.

- 44505 RETRACTABLE/REMOVABLE WHEELS



Overall size:
194x68xh 52/94 cm
Padded top length: 190 cm
Weight: 80 kg

44510



SUN 2-SECTIONS VARIABLE HEIGHT TREATMENT COUCH

- 44530 SUN 2-SECTIONS VARIABLE HEIGHT TREATMENT COUCH - orange - 3
- 44536 SUN 2-SECTIONS VARIABLE HEIGHT TREATMENT COUCH - any colour*

*available in 20 days, see below available colours

Couch made in high quality tubular that makes it very sturdy. The cushions can be reclined by a gas spring activated by an ergonomic lever under the top frame.

Head section movable to +45° and to -30°.

Height adjustable thanks to the two electrical columns by a push-button panel.

High density, rubber padded, fire retardant and Class 1 IM top, covered in flame retardant Class 1 IM coated fabric (synthetic leather).

Washable and disinfected with common detergents.

Overall size: 195x68xh 48/89 cm. Weight: 80 kg.

Complies with: EU 93/42 CEE. Maximum load: 200 kg.

Supplied with mouth/nose hole plug, paper roll holder, 2 adjustable armrests and 4 adjustable feet.

- 44505 RETRACTABLE/REMOVABLE WHEELS

- 44540 WEDGE CUSHION 50x50xh 15 cm - orange

- 44545 WEDGE CUSHION 50x50xh 15 cm - any colour*

- 44550 SEMI-CYLINDRICAL CUSHION 20x50xh 10 cm - orange

- 44555 SEMI-CYLINDRICAL CUSHION 20x50xh 10 cm - any colour*

*available in 20 days, see below available colours

Arm rest
35x13 cm

Head section
65x36 cm



44530

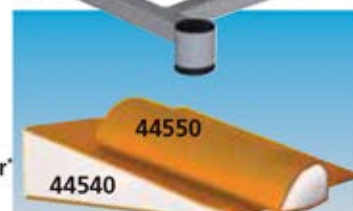

44540

44550



44530
+ 44505



KING EXAMINATION COUCH

KING EXAMINATION COUCH

Strong and stilish structure in oval tube 50x25 mm painted with metallic grey epoxy powder. Top in washable, fire proof, leatherette material class 1 IM with high density padding. Head section adjustable by mechanical system.

Maximum load: 150 kg.

Size: 190x60xh 80 cm.

Delivered in kit form.

Made in Italy.

GIMA Code	KING EXAMINATION COUCH
27614	King examination couch - water green - 5
27615	King examination couch - white - 7
27616	King examination couch - blue - 9
27617	King examination couch - black - 6
44486	King examination couch - any colour*
KING EXAMINATION COUCH WITH HOLE	
27618	King examination couch - green
27619	King examination couch - white

*available in 20 days, see below available colours



27978

27979

ACCESSORIES

27511	Couch roll holder
27978	Foot stool - 1 step
27979	Foot stool - 2 steps



27616

27619



KING PLUS EXAMINATION COUCH

- 44490 KING PLUS EXAMINATION COUCH - blue - 9
- 44491 KING PLUS EXAMINATION COUCH - beige - 2
- 44496 KING PLUS EXAMINATION COUCH - any colour*

*available in 20 days, see below available colours

Same as King examination couch, but with extra thick 7 cm mattress with lateral white band



Yellow Beige Orange Red Water green



Black White Lilac Blue Green



44490



44491

ELITE EXAMINATION COUCH

- 44500 ELITE EXAMINATION COUCH - blue - 9
- 44503 ELITE EXAMINATION COUCH - any colour*

*available in 20 days, see below available colours

Stylish, comfortable and innovative examination couch available in 10 colours with lateral white band. Realized with high quality furniture tubing that guarantees stability and robustness.

The couch is made with rectangular and rounded tubing, Uni 7947/81 and 8913, DIN 2394.

Fireproof rubber padding covered with class 1 IM fireproof woven imitation leather.

Adjustable head section through 2 cogwheels.

The roll holder, included, can be placed in the feet or in the head side. 4 adjustable feet.

Size 193x68xh 78 cm. Padding size 190x68xh 7 cm.

Max. load 200 kg. Weight 70 kg.

Disassembled, very simple to assemble.

Made in Italy.

- 44505 RETRACTABLE/REMOVABLE WHEELS



LOAD 200 KG



44503

COUCH PAPER ROLLS

COUCH PAPER ROLLS

A complete range of hygienic and resistant couch paper manufactured in Italy in pure cellucotton or cellucotton/polythene. Each roll is individually packed in plastic bag for best protection. Atoxic. Available with standard 38 or 40 cm perforation or 190 cm perforation (full person size).

• 27418 COUCH ROLL HOLDER

Adjustable roll holder suitable for round (Ø 27-30 mm) or square (27-30 mm x 27-30 mm) metal couch leg.

OTHER SIZES OF COUCH ROLL PAPER AVAILABLE ON REQUEST



COUCH PAPER ROLLS

MATERIAL	Cellucotton embossed		Microembossed glued mikrogeprägt verleimt - gaufré collé						Pure wadding of cellulose ply coated with a polythene protection			
	code	27410	27411	27412	27424	27427	27428	27432	27419	27414	27413	27415
Colour	white	white	white	white	white	white	white	white	white	light blue	white	white
Ply	1 ply	2 ply	2 ply	2 ply	2 ply	2 ply	2 ply	2 ply	2 ply	14 g/m ² polyth.	14 g/m ² polyth.	8 g/m ² polyth.
Weight	30 g/m ²	2x20 g/m ²	2x17 g/m ²	2x17 g/m ²	2x17 g/m ²	2x17 g/m ²	2x17 g/m ²	2x17 g/m ²	2x17 g/m ²	26/28 g/m ²	26/28 g/m ²	26/28 g/m ²
Length	95 m	47.5 m	46 m	50 m	100 m	50 m	80 m	80 m	80 m	50 m	50 m	50 m
Height	50 cm	59 cm	50 cm	50 cm	50 cm	59 cm	59 cm	59 cm	59 cm	50 cm	50 cm	60 cm
Number of sheet	250	125	135	132	263	132	210	42	132	132	132	125
Perforation	38 cm	38 cm	34 cm	38 cm	38 cm	38 cm	38 cm	190 cm	38 cm	38 cm	38 cm	40 cm
Rolls per box	6	6	9	9	6	9	6	6	6	6	6	6

EXAMINATION COUCHES

- 27401 EXAMINATION COUCH - chromed - black
- 27402 EXAMINATION COUCH - white painted - grey
- 27444 EXAMINATION COUCH - white painted - green

STOOLS: see matching stools page 141

Suitable for medical office or small surgeries.

Easy to assemble, following enclosed instructions.

Comes complete with mattress.

Upholstery in two sections:

one 130x61xh 5.5 cm fixed

and a 50x61xh 5.5 cm backrest

adjustable through different positions.

Delivered in kit form.

Universal couch roll holder
(code 27418, not included)

Made in Italy.

• 27418 COUCH ROLL HOLDER

Adjustable roll holder suitable for round (Ø27-30 mm) or square (27-30 mm x 27-30 mm) metal couch leg.

• 27404 CLASSIC EXAMINATION COUCH - chromed - beige

• 27405 CLASSIC EXAMINATION COUCH - chromed - blue

- backrest with hole

• 27445 CLASSIC EXAMINATION COUCH - chromed - apricot

Chromed mainframe and legs constructed in chrome-plated steel.

Legs fitted with plastic feet.

The two-section top has resilient foam padding covered with washable and fire-proof plastic material.

Backrest fully adjustable.

Available in beige, blue, apricot colour.

Other colours on request, minimum 10 pieces.

Size: 180x57xh 73 cm.

Maximum load 100 kg.

Delivered in kit form.

Made in Italy.

• 27408 MOUTH-NOSE HOLE PLUG for code 27405 - blue

STOOLS: see matching stools page 141

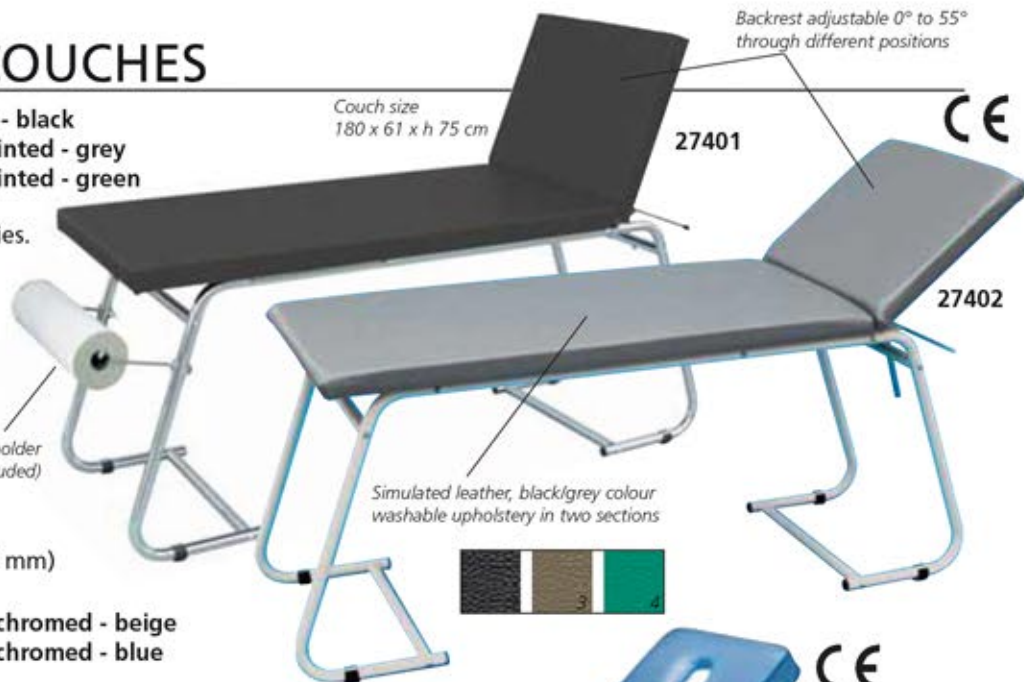

EXAMINATION AND TREATMENT TABLE - HIGH LOAD

- 27622 STANDARD TREATMENT TABLE - any colour**
- 27623 STANDARD TREATMENT TABLE - blue*
- 27624 STANDARD TREATMENT TABLE - cream*
- 27626 LARGE TREATMENT TABLE - any colour**
- 27627 LARGE TREATMENT TABLE - blue*

AVAILABLE IN 6 COLORS



- 1 Black
- 2 Blue
- 3 Grey
- 4 Green
- 5 Cream
- 6 Apricot

High-density foam padding. Superior cover finish made of high-quality fireproof simulated leather. Vinyl is resistant to disinfectants, urine, and blood.



WIDTH 80 cm

MAX LOAD - 200 kg

Professional examination and treatment table with one movable section and manual adjustment.

Sturdy detachable metal structure painted with scratch-proof, non corrosive epoxy powder.

The section trim facilitates reaching the patient.

The head section has an extended mouth-nose hole.

Load 180 kg (standard), 200 kg (large).

Made in Italy

- 27629 COUCH ROLL HOLDER
- 27630 MOUTH-NOSE PLUG - any colour**
- 27631 MOUTH-NOSE PLUG - blue
- 27620 MOUTH-NOSE PLUG - cream

* usually in stock

** available in 30 days



27622

WOODEN COUCHES

WOODEN COUCHES

Comfortable couches, ideal for physical therapy, cardiology and wellness centres. Superior quality wood. Back rest adjustable in 13 positions. Resilient foam padding covered with washable weave. Padding in beige colour.

Size: 190x70xh 70 cm.



27416



27417+27409

Mouth nose hole plug included

Maximum load: 150 kg

- 27416 WOODEN COUCH - beech
- 27417 WOODEN COUCH - with face hole - beech
- 27443 DANTE WOODEN TROLLEY - beech
- 27409 COUCH ROLL HOLDER for 27416 and 27417

Couch roll holder included with 27450 and 27451. Delivered in kit form. Easy assembly, tool provided. Made in Italy.



27451

27452

Size 50x40xh 77 cm



27450

Maximum load: 200 kg

- 27450 FIRENZE WOODEN COUCH - wenge
- 27451 FIRENZE WOODEN COUCH - with face hole - cherry wood
- 27452 DANTE WOODEN TROLLEY - cherry wood

SUITCASE COUCH

27407 SUITCASE COUCH

Chromed steel and folding legs. Upholstered covering in washable material. Resin padded. Available in black colour. Weight: 19 kg - Max load: 95 kg. Supplied with a velvet bag for easy transport. Made in Italy.



27407

Couch size: 185x64xh 70 cm (open)
95x65x16 cm (folded)

ALUMINIUM SUITCASE COUCH

27406 ALUMINIUM SUITCASE COUCH with hole (22x12)

Light, foldable, two sections, suitcase couch with aluminium frame. Central double legs for improved safety and block system on the hinges. Head rest with mouth/nose hole. Upholstered and covered with simulated leather. Maximum load: 110 kg. Weight: 13 kg. Made in Italy.



27406

Size: 62x182xh 75 cm

FOLDABLE MASSAGE TABLE - WOOD OR ALUMINIUM



WOODEN 2-SECTIONS



WOODEN 3-SECTIONS



ALUMINIUM 2-SECTIONS

- 44000 2-SECTION WOODEN MASSAGE TABLE - black
- 44001 2-SECTION WOODEN MASSAGE TABLE - blue
- 44002 2-SECTION WOODEN MASSAGE TABLE - turquoise
- 44003 2-SECTION WOODEN MASSAGE TABLE - cream

Two-section foldable height adjustable massage table with German beech wood frame and PVC vinyl cover with 5 cm foam thickness.

Tables are supplied with headrest, hanged armrest, mouth-nose plug and carrying bag.

Product open size: 185x70xh 62/87 cm

Packing size: 95x20xh 75 cm

Net/Gross weight: 14/17 kg

Maximum working load: 227 kg (500 lbs)

Manual: GB, FR, IT, ES, PT, DE

Carrying bag for all tables



- 44011 3-SECTION WOODEN MASSAGE TABLE - blue
 - 44013 3-SECTION WOODEN MASSAGE TABLE - cream
- Three-section foldable height adjustable massage table with German beech wood frame and PVC vinyl cover with 5 cm foam thickness. Tables are supplied with headrest, armrests, hanged armrest, mouth-nose plug and carrying bag.

Product open size: 185x70xh 62/87 cm

Packing size: 95x20xh 75 cm

Net/Gross weight: 16/19 kg

Maximum working load: 227 kg (500 lbs)

Manual: GB, FR, IT, ES, PT, DE



- 44020 2-SECTION ALUMINIUM MASSAGE TABLE - black
 - 44021 2-SECTION ALUMINIUM MASSAGE TABLE - blue
 - 44024 2-SECTION ALUMINIUM MASSAGE TABLE - white
- Two-section foldable, height adjustable massage table with aluminium frame and PVC vinyl cover with 5 cm thickness. Tables are supplied with headrest, side armrests, hanged armrest, mouth-nose plug and carrying bag.

Product open size: 186x70xh 59/80 cm

Packing size: 95x20xh 75 cm

Net/Gross weight: 13/16 kg

Maximum working load: 200 kg (440 lbs)

Manual: GB, FR, IT, ES, PT, DE



MASSAGE BED WITH HOLE



- 27421 MASSAGE BED

Comfortable massage bed, with face hole and removable pillow.

Ideal for physical therapy and wellness centres.

Adjustable back rest 0 to 45 degree

Supplied with couch roll holder.

Product size: 183x61x75 cm

Packing size: 188x17x66 cm

Net/Gross weight: 28/31 kg

Maximum load: 175 kg

FOLDABLE MASSAGE CHAIR

- 44050 FOLDABLE MASSAGE CHAIR
- Comfortable foldable massage chair ideal for physical therapy and wellness centres. Made in PVC vinyl with 5-6 cm foam thickness Metal frame
- Packing size: 106x27xh 50 cm
- Net/Gross weight: 7/13 kg
- Maximum working load: 160 kg



Folded massage chair



WING SCREEN WITH TREVIRA CURTAINS



SCREEN WITH TREVIRA CURTAINS
Build up the screen you need choosing among 4 frames and 6 colours of Trevira curtains.

Wing screen

Aluminium alloy tubular frame mounted on feet or castors (Ø 50 mm).

Size: 150xh 170 cm (3 wings) or 200xh 170 cm (4 wings)

Trevira curtains are flame-proof (Class I), antiallergic, avoid bacterial growth, waterproof and highly resistant to abrasion.

Thick weft to avoid dust infiltration and improve privacy, washable up to 60°C.

Available in 6 colours to match any need.

Custom-made curtains available on request.

Made in Italy.



code	WING SCREEN FRAME without curtain
45560	3 wing screen
45561	3 wing screen with castors
45562	4 wing screen
45563	4 wing screen with castors

code	CURTAINS* IN TREVIRA 45xh 132 cm
45570	Curtains - light blue
45571	Curtains - blue
45572	Curtains - white
45573	Curtains - beige
45574	Curtains - green
45575	Curtains - peach



*you have to buy 3 or 4 curtains depending on frame you choose



3 OR 4 WINGS SCREEN WITH PLASTIC CURTAINS



Made in Italy

27970



27974

- 27970 3 WINGS SCREEN
 - 27971 3 WINGS SCREEN with castors
 - 27972 4 WINGS SCREEN
 - 27974 4 WINGS SCREEN with castors
- Aluminium alloy tubular frame.
Weight 5 kg (3 wings), 8 kg (4 wings).
Fire-retardant, foldable washable white plastic curtains mounted on feet or castors (Ø 50 mm).
Size: 150xh 170 cm - 3 wings (50 cm each)
200xh 170 cm - 4 wings (50 cm each)
Made in Italy.

SEPARATION SYSTEMS AND CURTAINS see page 106

2 OR 3 WINGS WARD SCREENS WITH TREVIRA OR COTTON CURTAINS

Width: 60+60+60 cm

Height: 180 cm

Width: 60+60 cm



45580



45579

- 45578 2 WINGS SCREEN - white cotton cloth
 - 45579 2 WINGS SCREEN - light blue Trevira
 - 45580 3 WINGS SCREEN - white cotton cloth
 - 45581 3 WINGS SCREEN - light blue Trevira
- Exclusive 2 or 3 wings ward screens with sturdy structure in oval tube (30x15 mm), painted with epoxidic powder metal grey.
Light blue Trevira curtains or white washable cotton cloth.
Equipped with 4 adjustable feet that ensure increased stability.
Class I Medical Device complying with European Directive 93/42
Made in Italy.

CABINETS FOR MEDICINES AND INSTRUMENTS - MADE IN ITALY

CABINETS ARE SUPPLIED DISASSEMBLED



27898

Size: 52x35x138 cm
Pack size: 65x26x134 cm
Weight: 31 kg



27899

Size: 75x37x164 cm
Pack size: 72x24x156 cm
Weight: 45 kg



27900

Size: 75x37x164 cm
Pack size: 72x24x156 cm
Weight: 50 kg



27902

Size: 79x36x186 cm
Pack size: 88x36x96 cm
Weight: 56 kg

- 27898 VALUE CABINET - 1 door
- 27899 VALUE CABINET - 2 doors

Cabinets made of enamelled steel sheet with tempered glass doors. Hinged glass door with lock and key. Three stainless steel shelves adjustable in height. Delivered in kit form.

- 27900 VALUE CABINET - 4 doors (hinged)
- 27902 VALUE CABINET - 4 doors (2 hinged, 2 sliding)

Cabinets made of enamelled steel sheet with 2 overlapped compartments. Upper compartment with 2 tempered glass door (hinged door 27900 or sliding door 27902), lock with key and 2 stainless steel, height adjustable shelves. Inferior compartment with 2 doors made of enamelled steel plate and 1 enamelled steel sheet shelf. Delivered in kit form.

CABINETS WITH 1, 2, 4 DOORS AND WALL CABINETS



27901

27905

27903

Lower section with 1 steel shelf



27912

Hanging cabinet with 2 lockable doors. Inside division in 2 compartments left side with 2 removable shelves, right side with 1 removable shelf.



27911

Hanging cabinet to keep medicine with 2 glass tempered doors and 2 tempered glass shelves adjustable on master rack to be hung by two holes on the back

GIMA CABINETS Choice of cabinets with epoxy coated steel structure and tempered glass. Rack-mounted adjustable glass shelves. Rubber feet.

TECHNICAL SPECIFICATIONS	27901	27905	27903	27911	27912
Door:	1	2	4	2	2
Adjustable glass shelves:	3	4	3	2	2
Weight kg:	30	47	45	16	18
Size cm:	53x36xh 144	75x38xh 169	75x38xh 169	60x30xh 60	80x33xh 45

- 27901 CABINET - 1 door
 - 27905 CABINET - 2 doors
 - 27903 CABINET - 4 doors
 - 27911 WALL CABINET - glass sliding door
 - 27912 WALL CABINET - painted door
- All cabinets are made in Italy.

DOCTOR CABINET



EN 60598-1
EN 60598-2-4

Metal tubular frame with fixed height 100 cm and flexible arm 38 cm.

• 27990 STUDIO LIGHT
Metal tubular frame with plastic base Ø 60 cm with 5 plastic wheels.

TECHNICAL SPECIFICATIONS
100 Watt lamp (not included)
Power supply: 230 V

code	Product	Description	Size	Weight
27920	DESK - with 2 drawers	Desk with 2 side drawers with locking top drawer and enamelled tubular steel frame	120x70x78	31
27403	EXAMINATION COUCH	Single-hinged examination table with aluminium tubular frame. Comes complete with simulated leather mattress (grey), backrest adjustable through different positions. Delivered in kit form.	176x60x78	22
27989	COAT HANGER	Free-standing coat hanger with chromed steel frame with 8 knobs and umbrella holder		5
27990	LIGHT	Not medical. 100 W. Aluminium tubular frame with 5 spoke base on 50 mm castors. Adjustable height thanks to flexible arm. Lamp not included.		3

STACKABLE CHAIRS



- 45001 STACKABLE CHAIR - blue
- 45002 STACKABLE CHAIR - grey
- 45003 STACKABLE CHAIR - peach
- 45006 STACKABLE CHAIR with arms - blue

Chromed steel frame, self-extinguishing plastic seat. Stackable up to 20 chairs. Weight 5 kg (45001-3), or 6.8 kg (45006). Self-extinguishing Class 1. Made in Italy.

CHAIRS



- 27932 CHAIR padded seat
Stainless steel white painted frame chair with grey padded seat and back. Stackable. Load 120 kg.
- 27933 CHAIR padded seat with armchairs
Same as 27932 but with padded arm-rests. Made in Italy.

S/S WASTE BINS WITH PEDAL

- 27984 WASTE BIN 9.5 l - with pedal - Ø 25xh 35 cm
Made of enamelled steel with plastic inner bucket - weight: 2 kg
- 27985 S/S WASTE BIN 9.5 l - with pedal - Ø 25xh 35 cm
Made of AISI 304 stainless steel with plastic inner bucket - weight: 2 kg
- 27986 S/S WASTE BIN 12 l with pedal - Ø 32xh 36 cm
Made of stainless steel AISI 430. Metal handle for easy emptying. Removable inner plastic bucket. Made in Italy.
- 27983 S/S WASTE BIN 70 l with pedal - Ø 42xh 72 cm
Made of stainless steel. Non-slip rubber pedal. Two lateral handles avoid fingers pinching. Galvanized inner bucket with handle. Made in Italy.



DOCTOR CABINET



code	Product	Description	code	Product
27919	DESK -with 2 drawers	Desk with 2 lockable side drawers with strong structure in oval tube painted with epoxy powder, metal grey. White work top with rubber edge and round corner. Size 130x71xh80 cm	27616	KING EXAM. COUCH See page 133
45581	WING SCREEN Trevira curtain	3 wings screen with sturdy structure in oval tube, painted with epoxy powder metal grey. Light blue Trevira curtains. Curtains specifications see page 137	30760	SIMPLEX LIGHT See page 204
45580	WING SCREEN	Same as above but with white washable cloth.	27984	WASTE BIN See page 139
27921	TROLLEY	Structure in oval tube, painted with epoxy powder metal grey. White shelves with PVC edge, guard-rail on 3 sides. Size 50x60xh80 cm	45211	STOOL See page 141
27987	COAT HANGER	Free standing coat hanger with 5 knobs, epoxy powder grey painted steel structure and umbrella holder.	45082	CREMONA CHAIR See page 142
			27979	FOOT-STOOL - two steps See below

DESK

• **27919 DESK with 2 drawers**
Desk with 2 lockable side drawers with strong structure in oval tube painted with epossidic powder, metal grey. White work top with rubber edge and round corner.
Size 130x71xh 80 cm
Made in Italy.



TROLLEY

• **27921 TROLLEY**
Structure in oval tube, painted with epossidic powder metal grey. White shelves with PVC edge, side-rail on 3 sides.
Size 50x60xh 80 cm
Maximum load: 30 kg
Made in Italy



FOOT STOOLS - 1 OR 2 STEPS

• **27980 FOOT-STOOL - one step - aluminium**
• **27982 FOOT-STOOL - two steps - painted**
Mounting steps with painted tubular frame and plastic foot board.
Load 90 kg.
Non slipping grey platform 40x20.
Size: 40x51xh 25 (27980), 40x53xh 44 (27982).
Made in Italy.

• **27978 FOOT-STOOL - one step**
• **27979 FOOT-STOOL - two steps**
Structure in oval tube 30x15 painted with epossidic powder. Non slipping black platform.
Size: 45x26xh 20 cm
44x40xh 22/45 cm
Maximum load: 100 kg
Made in Italy.

• **27976 FOOT-STOOL - one step - disassembled**
• **27977 FOOT-STOOL - two steps - disassembled**
Structure made of chrome plated steel tube with rubber feet. Non slipping black plastic platform.
Size: 40xh 24 cm (27976)
40xh 42 cm (27977)
Delivered in kit form.
45x27xh 9 cm (27976)
51x42xh 12 cm (27977)
Made in Italy.



DELIVERED DISASSEMBLED

HEIGHT ADJUSTABLE STOOLS - MADE IN ITALY



AVAILABLE IN 6 COLORS

- 45200 STOOL 1 - black
 - 45201 STOOL 2 - blue
 - 45202 STOOL 3 - grey
 - 45203 STOOL 4 - green
 - 45204 STOOL 5 - beige
 - 45205 STOOL 6 - apricot
- Padded simulated leather seat
 Ø 30 cm.
 Height adjustable 50 to 60 cm.
 Fire proof.
 Metal base with 5 castors.



- 45210 STOOL - black
 - 45211 STOOL - blue
 - 45212 STOOL - white
- Padded simulated leather seat
 Ø 36 cm.
 Height adjustable 50-60 cm
 Plastic base with 5 castors.

- 45220 STOOL - black
 - 45221 STOOL - white
 - 45222 STOOL - red
- Padded fire proof simulated leather seat and back. Height adjustable. Plastic base with 5 castors and chromed ring.



- 27950 STOOL - feet
 - 27951 STOOL - castors
- Stainless steel seat AISI 304 Ø 32 cm.
 Height adjustable 47-59 cm (27950).
 Plastic base. Made in Italy.

- 27948 STOOL - feet
- Stainless steel seat AISI 304 Ø 32 cm. Height adjustable 47-59 cm. Aluminium base with feet. Made in Italy.

- 27952 STOOL - grey
- Washable padded simulated leather seat Ø 31 cm. Height adjustable 50-62 cm. Plastic base with foot. Made in Italy.

- 27953 STOOL - grey
- Washable padded simulated leather seat Ø 31 cm. Height adjustable 54-66 cm. Plastic base with 5 castors. Made in Italy.

HEIGHT ADJUSTABLE STOOLS

ERGONOMIC HEIGHT ADJUST. STOOLS



- 45230 STOOL - black
 - 45231 STOOL - white
 - 45232 STOOL - blue
 - 45233 STOOL - green
 - 45234 STOOL - beige
- Padded simulated leather seat
 Ø 33 cm.
 Height adjustable 53 to 68 cm
- 45228 CASTORS - spare
- 45240 STOOL - black
 - 45241 STOOL - white
 - 45242 STOOL - blue
 - 45243 STOOL - green
 - 45244 STOOL - beige
- Padded simulated leather seat
 Ø 33 cm with backrest.
 Height adjustable 53 to 68 cm
- 45228 CASTORS - spare



- 45250 ERGO STOOL - black
 - 45251 ERGO STOOL - white
 - 45252 ERGO STOOL - blue
- Ergonomically designed comfortable stool with saddle-shaped seat and height adjustment with a gas piston.
 Height adjustable 52 to 67 cm
- 45228 CASTORS - spare
- 45260 ERGO B STOOL - black
 - 45261 ERGO B STOOL - white
 - 45262 ERGO B STOOL - blue
- Ergonomically designed comfortable stool with saddle-shaped seat. Three levers allow adjustment of height, backrest angle and seat.
 Height adjustable 62 to 78 cm
- 45228 CASTORS - spare

OFFICE CHAIRS WITH OR WITHOUT ARMREST - MADE IN ITALY



- 45071
- 45070
- 45065
- 45075
- 45060
- 45076

45075

Functional office upholstered chair, with armrests and polypropylene swivel base, movable backrest with permanent contact.

CUNEO CHAIR without armrest

	Red	Grey	Black	Blue	Any colour*
Fabric	-	-	-	45060	45063
Leatherette	-	-	45065	-	45069

CUNEO CHAIR with armrest

Fabric	45070	45071	-	-	45073
Leatherette	-	-	45075	45076	45079

Available in 30 days. Minimum order 12 pieces.

Select colour on www.gimaltaly.com and indicate with order

Weight	Backrest height	Seat height	Width	Depth
12 kg	98/111 cm	42/52 cm	56 cm	49 cm



- 45081
- 45082
- 45083

45082

Superior quality chair with neat lines, upholstered seat and backrest for greater comfort, swivel base, armrests, permanent contact movement of the backrest.

High density foam.

UNI EN 1335/1/2/3. Maximum load: 110 kg.

CREMONA CHAIR with armrest

	Red	Grey	Blue
Fabric	45083	45081	45082

Weight	Backrest height	Seat height	Width	Depth
12 kg	90/107 cm	45/52 cm	58 cm	44 cm



- 45091
- 45095
- 45092
- 45096

45091

Quality chair with upholstered seat and backrest, permanent contact movement of backrest and swivel base. Maximum load: 110 kg. UNI EN 1335/1/2/3.

VARESE CHAIR without armrest

	Red	Blue
Fabric	45091	45092

	Red	Blue
Fabric	45095	45096

Weight	Backrest height	Seat height	Width	Depth
11.6 kg	94/112 cm	46/59 cm	60 cm	47 cm

VISITOR CHAIRS



- 45030
- 45032
- 45036
- 45035

45030

- 45030 ISO - fabric - red
- 45032 ISO - fabric - blue
- 45035 ISO - leatherette - black
- 45036 ISO - leatherette - blue

Comfortable upholstered chair with 4 legged frame. Can be used for patient and waiting rooms, with Cuneo, Cremona and Varese chairs. Comfortable seat made of expanded polyurethane hit injected heliocell foams. Maximum load: 110 kg.

Weight	Backrest height	Seat height	Width	Depth
7 kg	82 cm	45 cm	53 cm	43 cm

EXECUTIVE CHAIRS



- 45122
- 45120
- 45122

45120

- 45120 SALISBURGO executive swivel chair - leather - black
- 45122 SALISBURGO visitor cantilever chair - leather - black

High and low back stylish executive chairs. Refined lines and maximum comfort. 2 positions tilting movement, swivel base, polypropylene armrests, height adjustable by gas pump. Maximum load: 110 kg.

GIMA code	Weight	Backrest height	Seat height	Width	Depth
45120	17 kg	118/128 cm	43/53 cm	62 cm	55 cm
45122	14 kg	95 cm	45 cm	62 cm	55 cm



45128

Maximum load: 110 kg

ELITE EXECUTIVE CHAIR
Executive low-backed or high-backed armchair. Fabric or leatherette. Steel and chrome plated base and arms. Height adjustable by gas pump.

ELITE low-backed chair - 83-93 cm

	Red	Black	Beige	Any colour*
Fabric	45124	-	-	45126
Leatherette	-	45127	45128	45132

ELITE PLUS high-backed chair - 101-111 cm

Leatherette	-	45136	-	45140
-------------	---	-------	---	-------

*Available in 30 days. Minimum order 4 pieces.

Select colour on www.gimaltaly.com and indicate with order

Weight	Backrest height	Seat height	Width	Depth
14.5 kg	83/93 cm	39/49 cm	51 cm	45 cm

*Low-backed chair

X-RAY ILLUMINATORS - LIGHT BOXES



X-RAY ILLUMINATORS

GIMA light boxes are designed according to clinical standards for an extra white light for an accurate and precise reading of any detail. They incorporate a 3 mm acrylic screen compliant with safety norms (fuses, Schuko plug, green light On/Off, ...). Can be used on the table placed horizontally or vertically, depending on model or wall mounted.

Body made of oven-fired epoxy powder coated aluminium and injected ABS (colour RAL 7035).

TECHNICAL SPECIFICATIONS

Colour temperature: Cool white 6,500 °K
 Power supply: 230 V - 50 Hz (60 Hz available with surcharge)
 Protection fuse: 2x1A
 Bipolar light switch
 Schuko plug with 2 m cable
 All components UL, DVE, IMQ approved
 Made in Italy



code	X-RAY ILLUMINATORS - LIGHT BOXES	External dimensions (cm)				Types
		Length	Height	Depth	Weight	
27364	Light box 38x38 cm	43	43	12	6	1 panel
27365	Light box 38x62 cm	67	43	12	8	1,5 panel
27366	Light box 38x92 cm	97	43	12	11	2 panels
27367	Light box 38x122 cm	127	43	12	14	3 panels
27368	Light box 38x153 cm	158	43	12	18	4 panels
27369	Light box 76x122 cm	127	2x43	12	28	2x3 panels
27370	Light box 76x153 cm	158	2x43	12	36	2x4 panels
27372	Light box 92x38 cm	43	97	12	11	2 panels vertical
27373	Light box 122x38 cm	43	127	12	14	3 panels vertical
27378	Neon tube for 27364					
27379	Neon tube for 27366, 27372					

VALUE FOR MONEY LIGHT BOXES



GIMA X-ray illuminators have been designed according to clinical recommendations for an extra white light to give an accurate and precise reading of any detail. Manufactured with metacrylate screen, and according to safety norms (fuses, Schuko plug, green light on/off, ...). The unique film gripping system gives full use of viewing area. White colour. Made in Italy.

AVAILABLE ALSO WITH ADJUSTABLE LIGHT

code	X-RAY ILLUMINATORS - LIGHT BOXES	External dimensions (cm)				Types
		Length	Height	Depth	Weight	
27356	36.5x40 cm	38,5	43,5	11	5,4	1 panel
27357	36.5x40 cm - adjustable	38,5	43,5	11	5,4	1 panel
27358	75x40 cm	77	43,5	11	11	2 panels
27359	Round fluorescent light - spare					

ILLUMINATED AND NOT ILLUMINATED OPTOMETRIC CHARTS



MONOYER 3m • 27381

MIXED DECIMAL 3m • 27382

ARMAGNAC 5m • 27380

CHILDREN 3m • 27383

ANIMALS 5.5m • 27384

GIMA luminous optotypes have been designed according to clinical recommendations for an extra white light to give an accurate and precise reading of any detail. Manufactured with acrylic screen, and according to safety norms (fuses, Schuko plug, green light On/Off,...)

OPTOMETRIC CHARTS	Illuminated GIMA code	Not illuminated GIMA code
Armagnac - 5 m	27380	27390
Monoyer - 3 m	27381	27391
Mixed decimal - 3m	27382	27392
Children - 3 m	27383	27393
Animals - 5 m	27384	-
Spare Tube 700	27388	-

TECHNICAL SPECIFICATIONS

Viewing Area: 24 x 62 cm 24 x 61 cm
 External dimensions: 29.5x67.5x12 cm 29 x 66 x 2.5 cm
 Weight: 6 kg 2 kg
 Power supply: 230 V - 50 Hz (60 Hz on request) only 27380-4
 Made in Italy
 Other specifications like x-ray illuminators 27364-72



See economic optometric charts at page 227.

LED ULTRA SLIM X-RAY ILLUMINATORS - DESKTOP AND WALL

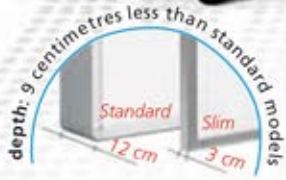
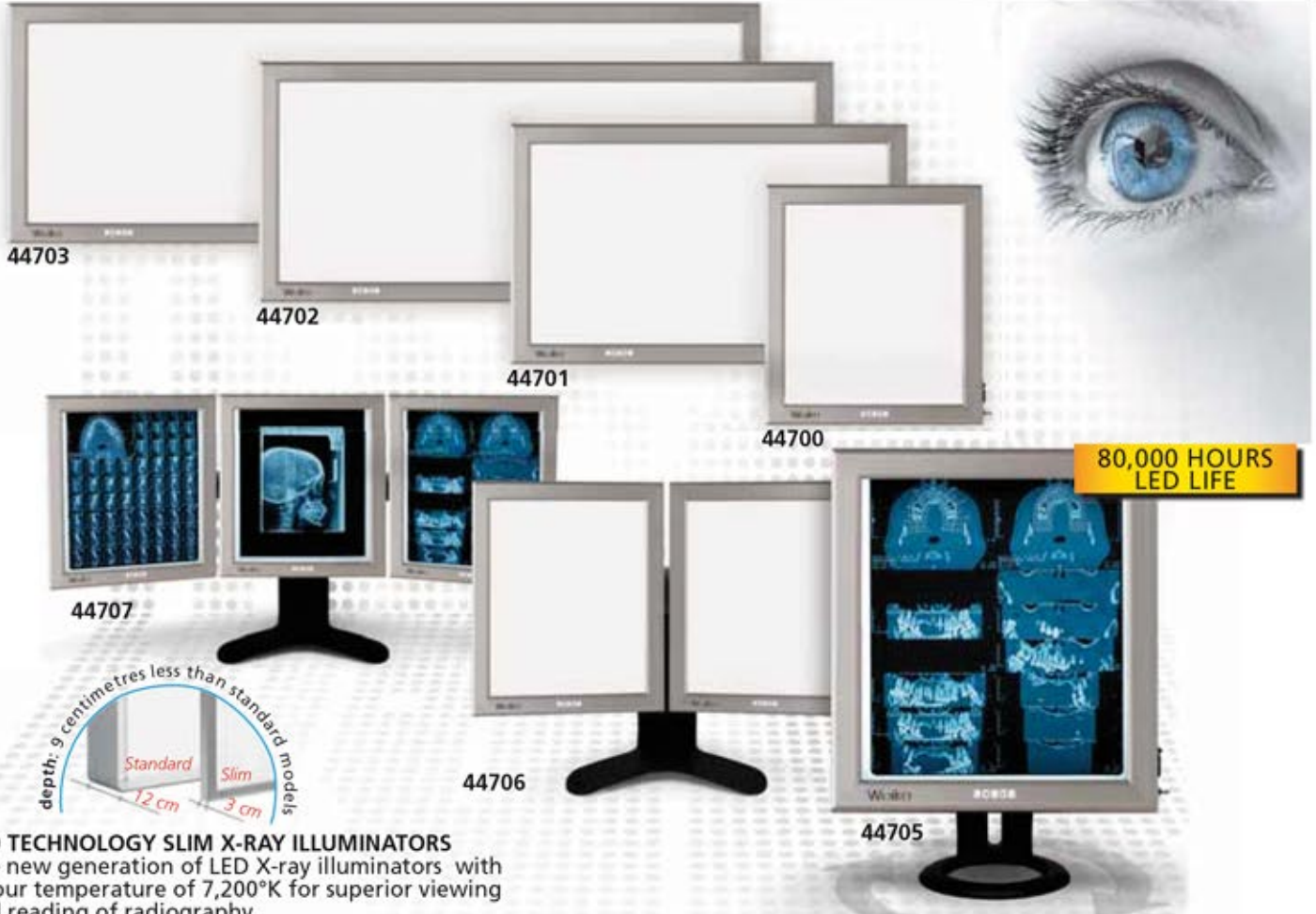

LED TECHNOLOGY SLIM X-RAY ILLUMINATORS

The new generation of LED X-ray illuminators with colour temperature of 7,200°K for superior viewing and reading of radiography. Complete elimination of light flickering and 3,500 cd/mq luminance for more uniform light diffusion. Frame in antiscratch anodized aluminium. Film gripping system incorporated. Dimmer for luminance adjustment from 30% to 100%. - FAS: automatic switching on/off at the positioning/removal of the film.

Economic advantages:
 - LED life 80,000 hours, with low maintenance costs
 - low energy consumption compliant with European law
 Double support for horizontal or vertical wall mounting or desktop.

Fully adjustable desktop model:

- Position of panel can be totally adjusted:
- height adjustment 13 cm
 - inclination 35° (+25°/-5°)
 - vertical or horizontal positioning (44705 only)
 - horizontal rotation 10° (270° for 44705 only)

code	WALL LED SLIM VIEWERS viewing area	External size - cm			Weight kg	Switches	Types
		Length	Height	Depth			
44700	Light box 42x36 cm	46	50.5	3	4	1	1 panel
44701	Light box 42x72 cm	82	50.5	3	8	1	2 panels
44702	Light box 42x108 cm	118	50.5	3	12	1	3 panels
44703	Light box 42x144 cm	154	50.5	3	16	1	4 panels

code	DESKTOP LED SLIM VIEWERS viewing area	External size - cm			Weight kg	Switches	Types
		Length	Height	Depth			
44705	Light box 42x36 cm x1	46x1	50.5	3	6	1	1 panel
44706	Light box 42x36 cm x2	46x2	50.5	3	20	2	2 panels
44707	Light box 42x36 cm x3	46x3	50.5	3	26	3	3 panels

TECHNICAL SPECIFICATIONS

Colour temperature: Cool white 7,200°K
 Power supply: 110-230 V - 50/60 Hz
 Conformity to Low Voltage Directive 2006/95/CE
 Conformity to Electro Magnetic compatibility 2004/108/CE
 Conformity to EEC directive 2007/47 medical Device Class I
 All components UL, DVE, IMQ approved

Brightness: 3,500 cd/m²
 LED life: 80,000 hours

Made in Italy

PANELS ADJUSTMENT

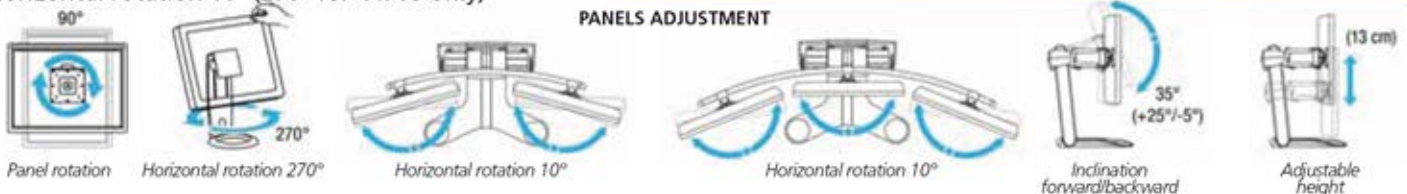

LED ULTRA SLIM OPTOMETRIC CHARTS

LED ULTRA SLIM OPTOMETRIC CHARTS

New generation of optometric charts with same specifications as above X-ray illuminators. Made in Italy.

code	LED ULTRA SLIM OPTOMETRIC CHARTS - WALL		
	Viewing area	External size	
44710	Armagnac - 5 m	25.5x63 cm	34x72x4 cm
44711	Monoyer - 3 m	25.5x63 cm	34x72x4 cm
44712	Mixed decimal - 3m	25.5x63 cm	34x72x4 cm
44713	Children - 3 m	25.5x63 cm	34x72x4 cm

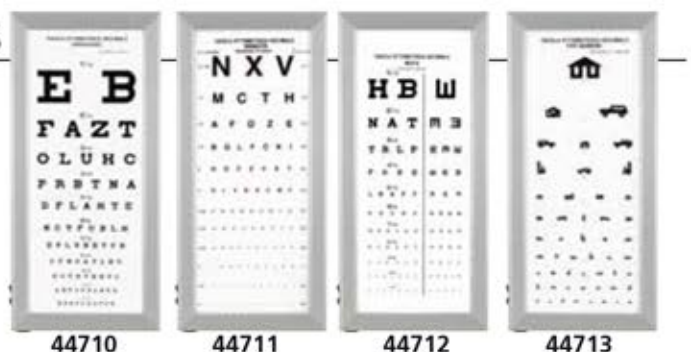

AIR COMPRESSION THERAPY SOLUTIONS

All human body is supplied by peripheral circulation of blood and lymph.

Our systems help patients to recover from their disease by improving blood and lymph circulation and metabolism.

Our systems consist of air chambers and an air pump offering air compression massage to legs, arms or waist.



• **28430 MAYLEA GIMA DIGITAL COMPRESSION MASSAGE with 2 legs (98x38 cm) - 4 chambers, 1 single and 1 double hose and 2 plastic feet guides**

Skip function to choose directly the parts to be massaged. Fully digital management. Autocalibration functions. Manual: GB, FR, IT, ES. This system can operate with 3 compression modes (A, B, C).

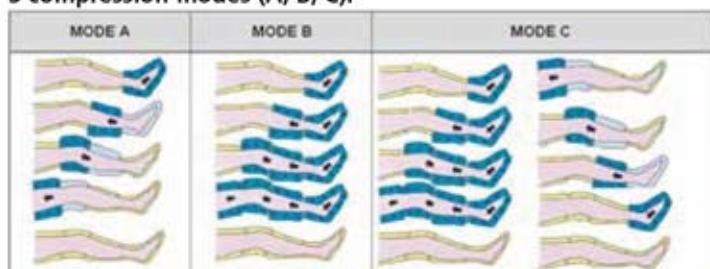

TECHNICAL SPECIFICATIONS
 - pressure sensor
 - digital timer (10, 20, 30, 40 min)
 - digital pressure gauge (10-180 mmHg)
 - one touch connection hose plug
 - body size: 190x250x210 mm
 - body weight: 3 kg

- 28435 LEG 93x32 cm
- 28434 LEG EXTENSION ZIPPER - 10 cm extra extension
- 28440 DOUBLE HOSE - to use two leg cuffs at the same time - spare
- 28436 ARM CUFF unique size - 86x29 cm
- 28437 WAIST CUFF 130x38 cm

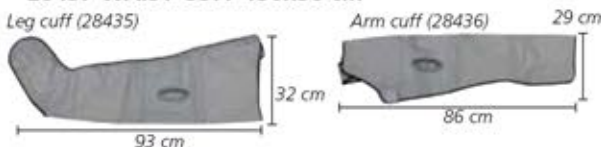

• **28441 MK400L PROFESSIONAL COMPRESSION SYSTEM with 2 legs (XL), and 2 single hoses**

MK400L is a professional air compression therapy system with essential functions for different kinds of patients. This system provides 3 compression modes (wave, squeezing, double squeezing), reverse compression settings, skip functions to select directly part to be pressurized and compression speed controller. Touch key pad display. Manual: GB, IT, ES.

TECHNICAL SPECIFICATIONS
 - Pressure range: 10-200 mmHg
 - Automatic pressure detection
 - Operating voltage: 220-240 V, 50/60 Hz, 50 VA
 - Use time: 1-90 minutes
 - Body size: 415x310x160 mm
 - Body weight: 6.5 kg



- Medical indications**
- DVT (Deep Vein Thrombosis)
 - Lymph edema
 - Post-paralytic
 - Limb convulsion
 - Venosclerosis
 - Chronic venous insufficiency (CVI)
 - Post-mastectomy
 - Post-trauma
 - Spinal cord injury
 - Varicose veins
 - Sciatica
 - Sprains
 - Diabetes
 - Arterial insufficiency

- Home care indications**
- Lymph edema
 - Diseases caused by interrupted blood circulation
 - Cellulitis fat dissolution
 - Pregnant woman's limb treatment
 - Numb feet or hands
 - Cold feet or hands
 - Settlement of stress
 - Exercise effects
 - Insomnia
 - Healthier body and elastic skin
 - Old age, weakness and fatigue



Possibility to use 2 leg cuffs at the same time with double hose (code 28440)



PROFESSIONAL AIR COMPRESSION SYSTEM



- 28442 LEG CUFF L - 6 CHAMBERS - spare
- 28443 LEG CUFF XL - 6 CHAMBERS - spare
- 28444 LEG EXTENSION ZIPPER XL - 10 cm extra extension for 28443
- 28445 SINGLE HOSE - spare
- 28446 ARM CUFF - 6 CHAMBERS - universal
- 28447 WAIST CUFF - 6 CHAMBERS - min-max girth 94-125 cm

A mode (Wave)
 The selected air chamber inflates and deflates by one chamber sequentially from foot up to thigh.

B mode (Squeezing)
 After all the selected air chambers inflate sequentially from foot up to thigh the inflated chambers deflate at once.

C mode (B mode two times + Reverse A mode 1 time)
 The selected air chambers inflate and deflate by two chambers sequentially from foot up to thigh.
Reverse setting: it allows to change automatically the selected mode to reverse mode.

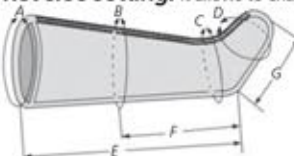

Cuff Size	Leg dimension (cm)						
	A	B	C	D	E	F	G
L	64,0	49,5	40,5	34,5	75,0	38,0	28,0
XL	73,5	55,0	42,0	35,5	85,0	43,0	31,0

CR200 - PROFESSIONAL TECAR THERAPY

• 28364 CR200 TECAR THERAPY

Diathermy, also known as TECAR Therapy (meaning Capacitive and Resistive Energy Transfer), is a therapy stimulating the physiological healing process by accelerating the recovery time of motor function. Diathermy stimulates tissues endogenous heat production through the interaction of electromagnetic field and tissue. The heat is increased in a uniform controlled way. The electromagnetic interaction results in an ionic flow and consequently increases blood flow in the treated area. This process stimulates endogenous substances release (in particular cortisol and endorphins) that are necessary to reduce inflammations, pain and edemas. The new CR200 resistive/capacitive diathermy is a modern and highly performing device easy to use by professionals. Preset programmes help use the device from the start. Moreover the device can set parameters (power, time therapy, capacitive/resistive modes) according to therapeutic needs. It allows the memorization of customized programmes. In this way patient protocols are easily consulted by therapists at any time. Equipped with a wide graphic display showing therapy parameters and different working modes. Selectable software language (GB, FR, IT, ES).

• 33251 TECARTHERAPY CONDUCTIVE CREAM 1 I

Moisturizing conductive cream ideal for Tecar therapy.

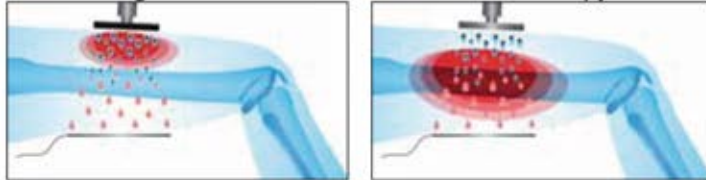

Capacitive mode

Electrode coated with ceramic material (mobile) and return plate (fixed). Indicated especially for soft tissues (muscle mass and lymphatic/vascular system). Benefits: specific intervention; easy control of the treated area.

Resistive mode

Non isolated electrode (mobile) and return plate (fixed). Indicated especially for tissues with greater resistance (bones, joints, tendons, ligaments, cartilages). Benefits: high level of diathermy; chronic diseases with fibrosis and degeneration

STANDARD ACCESSORIES

- 1 multi-function probe for capacitive and resistive mode
- 2 electrodes Ø 35 mm (1 resistive + 1 capacitive) with 9.61 cm² effective working area
- 2 electrodes Ø 60 mm (1 resistive + 1 capacitive) with 28.26 cm² effective working area
- 1 integrated support for probe
- 1 steel plate
- Bottle of conductive cream 1 kg
- Power supply cable
- User Manual: GB, IT, ES, FR



MAIN TREATMENTS	
Skeletal-muscle pathologies Chondropathy Coxarthrosis	Lumbalgy, pubalgy and acute/chronic pain Osteoarticular pathologies
24 REHAB PROGRAMMES knee arthrosis, arthrosynovitis, bursitis, cervicgia, patellar chondropathy, bruises, coxarthrosis, sprain, articular pain, oedema, epicondylitis, epitrochleitis, spinal disk hernia, plantar fasciitis, gonarthrosis, ACL, lymphedema, back pain, meniscopathy, neuropathy, peri-arthritis, muscle sprain, acute tendinitis, chronic tendinitis	10 SPORT PROGRAMMES Muscle contractures, bruise, muscle stretching, sprain, haematomas, tendon injury, superficial massage, deep massage, muscle recovery, muscle sprain

TECHNICAL SPECIFICATIONS

- Power supply: 100-240 V, 50/60 Hz
- Max power consumption: 300 W (50 ohm load)
- Carrier frequency: 485 kHz
- Adjustable power: 0-100%
- Touch screen graphic display 7"
- Preset programmes, free memories

I-TECH LA 500 LASER THERAPY

• 28410 I-TECH LA 500 LASER THERAPY

Laser therapy device equipped with a new probe with an emitting diode that allows beam laser application directly to the treatment area.

I-TECH LA 500 is able to stimulate deep tissues by promoting a rapid cellular regeneration thanks to 500 mW power output and 810 nm wavelength. Professional user can adjust power output, therapy time and operation mode (continuous or pulse).

I-TECH LA 500 guarantees a fast intervention for the treatment of inflammatory and degenerative pathologies in orthopedic, neurologic and dermatologic area.

Thanks to its high performance healing time is significantly reduced. Supplied with probe, belts for probe fastening and safety glasses.

Manual in: GB, IT, FR, ES.



LASER THERAPY

The laser therapy uses the effects of energy produced by the light source penetration into the tissues. Biochemical reactions are activated across the cellular membrane. It has been observed that right doses of Laser light can stimulate cellular functions, in particular into the cells damaged by functional deficits. The main effects of Laser therapy are:

- improved blood flow: capillary and artery vasodilatation that results in local heat increase
- biostimulation: accelerated tissues repair, stimulation of protein synthesis, ADP production, electrolyte changes in the intra- and extra-cellular fluids and mitosis of fibroblasts, increase of collagen and elastin
- anti-inflammatory effect
- anti-oedema effect: lymphatic drainage stimulation
- analgesic effect

- TECHNICAL SPECIFICATIONS**
- Power supply: 230 V, 50-60 Hz, ±10%
 - Maximum laser output: 500 mW ± 20%
 - Adjustable laser power output: 0%-100%
 - Laser diode wavelength: 810 nm
 - Beam divergence angle: 260 mrad
 - Continuous output emission
 - Fixed emission frequency
 - Fixed width duration
 - Continuous or pulse mode of operation
 - Pointing red light
 - Diode probe (with reserved connection)
 - Adjustable therapy time: 0-30 minutes
 - Diameter of laser beam: <10 mm
 - Dimensions: 300x150x120 mm

- MAIN TREATMENTS**
- Polyarthrits - Epicondylitis/Epitrochleitis - Knee pain - Myositis
 - Oedema - Sciatalgy/Lumbago - Articular sprains - Chronic Tenosynovitis - Muscle strains - Overcharge pathologies - Ecchymosis - Bursitis - Degenerative arthritis - Adhesive capsulitis - Arthrosis pains - Post-traumatic disorders
 - Scars - Rheumatic diseases

T-ONE COACH AND T-ONE MEDI SPORT - 4 CHANNELS ELECTROTHERAPY

• 28401 T-ONE COACH ELECTROTHERAPY - 4 channels
A high performant muscle stimulator designed to improve your physical activity. Thanks to easy to use programs, it represents the ideal device for not professional athletes and for sports lovers in general. It is not only a muscle stimulator equipment. It is supplied by TENS protocols for pain relief and injuries recovery.

• 28402 T-ONE MEDISPORT ELECTROTHERAPY - 4 channels
Professional equipment specifically designed for sport specialist users. Thanks to its muscle stimulation specialized programs it improves the sport performance. It is not only intended to increase your strength, it helps the recovery of sport injuries with specific treatment protocols.

Main features

- constant current generator (can guarantee a constant current even when skin condition changes, the device automatically stops in the event of accidental electrodes disconnection)
- four independent channels unit (up to 8 connectable electrodes)
- compensated biphasic square wave: current quantity from positive pole to negative one is constant to avoid polarization effect;
- monophasic wave generator (only for iontophoresis programs)
- 2+2 users programs
- backlight graphic colour display
- user feedback: the device recognizes patient connection
- soft-touch easy to use keyboard
- on-line 5 languages guide (GB, FR, IT, ES, DE) on display for fast instructions
- 4,8 V rechargeable battery pack

Size: 150x90x35 mm



- personalized programs for man and woman
- maximum intensity 240 mApp, with 1 mA step regulation
- 28351 PRE GELLED ELECTRODES 40x40 cm with cable - box of 4
- 28373 PRE GELLED ELECTRODES 45x80 cm with cable - box of 4
- 28381 IONOPHORESIS KIT - spare
- (1 elastic band, 2 silicone conductive electrodes, 2 sponges)

STANDARD ACCESSORIES

4 connection cables (8 connectable electrodes)
Kit of pre-gelled self-adhesive electrodes (square, rectangular, round)
iontophoresis kit: elastic belt, 2 silicone electrodes, 2 sponges, carrying bag (28402 only)
Internal Ni-Mh rechargeable battery pack and battery charger
Electrode position manual and user manual (GB, FR, IT, ES). On request DE

BEAUTY	REHA	TENS	NEMS	MEM	2+2
18 programmes 28401 and 28402	10 programmes only 28402	16 programmes 28401 and 28402	14 programmes 28401 and 28402	Only 28402	28401 and 28402
Firming up Toning up Definition Modelling Microlifting Lipolysis abdomen Lipolysis thighs Lipolysis glutei and hips Lipolysis arms Tissue elasticity Capillarization Heaviness in legs Face Microlifting Handy Trode Breast Microlifting Handy Trode Décolleté Microlifting Handy Trode Face Wrinkles Handy Trode Forehead Wrinkles Handy Trode Collagen	Ionophoresis L Ionophoresis M Ionophoresis H MENS microcurrent Haematomas Oedema Tens sequential Tens Burst Atrophy prevention Atrophy	Tens rapid Tens endorphinic Tens max values Inflammatory Neck pain Backache/Sciatic pain Sprains/Bruises Vascularization Muscle relaxant Hand and wrist pain Plantar stimulation Epicondylitis Epitroclea Periarthritis Tens Burst Microcurrent	Warming up Resistance Resistance strength Basic strength Fast strength Explosive strength Deep capillarization Muscle recovery Agonist/Antagonist Sequential tonic contractions Sequential phasic contractions Muscle relaxant Deep massage EMS Only 28402 30' Resistance 30' Resistance strength 20' Basic strength 20' Fast strength 20' Explosive strength 20' Hypertrophy	Tens mem 1 Tens mem 2 Tens mem 3 Tens mem 4 Tens mem 5 NEMS mem 1 NEMS mem 2 NEMS mem 3 NEMS mem 4 NEMS mem 5 NEMS alternated NEMS alternated Battery test	Tens rapid Tens endorphinic Firming up Toning up Definition Modelling Microlifting Muscle relaxant Massage Capillarization Only 28402 Inflammatory Resistance, Resistance strength Basic strength, Fast strength Explosive strength, Hypertrophy Face Microlifting Handy Trode Breast Microlifting Handy Trode Décolleté Microlifting Handy Trode Face Wrinkles Handy Trode Forehead Wrinkles Handy Trode

MIO-SONIC ULTRASOUND THERAPY DEVICE - 9 PROGRAMS

• 28309 MIO-SONIC ULTRASOUND THERAPY
Innovative and high performance device both for home use and professional use. It combines compactness and high performances in a small, light and easy to use applicator. The lightness and handiness allows a continuous use without any difficulty.

Mio Sonic can be used for the following applications:

- pain therapy;
- sport injuries;
- aesthetic treatments.

Supplied with gel bottle, carrying and storage bag, medical power supply and multilanguage manual: GB, FR, IT, ES. On request DE.



TECHNICAL SPECIFICATIONS

9 programs;
1 MHz ultrasound, maximum output power 6.4 W, maximum intensity 1.6 W/cm²;
Collimated ultrasound beam for an optimal penetration beam;
3 ultrasound beam intensity levels 0,08 W/cm² (low) - 0,8 W/cm² (medium) - 1,6 W/cm² (high);
Medical power supply;
Direct contact device (not suitable for water immersion)
Size-weight: 200x47x69 mm - 190 g



TREATMENTS		
Osteoporosis	Periarthritis	Adhesions
Arthritis	Tendinitis	Muscular contractures
Neuralgias	Pubalgy	Cramps
Cervicalgias	Tallonitis	Massage
Sciatalgy	Contusions	Drainage
Sprains	Chondropathy	Modelling
Cruralgy	Microlifting	Carpal Tunnel
Wrinkles	Epitrochleitis	Oedema
		Venous stagnation
		Arms cavitation
		Abdomen cavitation
		Limb cavitation
		Gluteus cavitation
		Lumbalgy
		Hematoma
		Acne
		Phonophoresis

ORTHOMAG LOW FREQUENCY MAGNETOTHERAPY - 2 PROGRAMMES

- Osteogenesis
- Biostimulation
- Pain management



28298



• **28298 ORTHOMAG low frequency magnetotherapy kit**
A professional low frequency magnetotherapy (PEMF) device that can be used everywhere. Lightweight, comfortable and flexible, fitting your body shape. Battery powered for dynamic use or power socket for use at home or in the office. Orthomag includes 2 programmes (75 Hz and 50 Hz) indicated for bone tissue pathologies, joint diseases and pain management. Up to 25 Gauss per programme. Supplied with rechargeable lithium battery 3.7 V 900 mAh, wall mount charger (cable 1.5 m), universal flexible applicator (cable 1.5 m), test emission magnet, 2 elastic bands (S and L), carrying bag, manual (GB, FR, IT, ES). On request DE.

In motion magnetotherapy

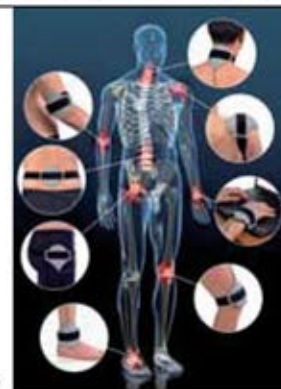

MAG 700 LOW FREQUENCY, HIGH INTENSITY MAGNETOTHERAPY



28296

• 28296 MAG 700 MAGNETOTHERAPY - 1 channel

New portable magnetotherapy ideal for home therapy. MAG 700 offers a high level of professional performances and it's indicated for several pathologies.

It allows comfortable home therapy through its basic accessories.

MAG 700 has 7 pre-set programmes for the treatment of several pathologies, 3 programmes identified by the working frequency (from

5 to 20 Hertz) and an Autoscan programme with continuous frequency variation for the treatment of both hard and soft tissues at the same time.

Possibility to adjust the magnetic field intensity for all programmes up to 70 Gauss.

Working frequencies are between 5 and 100 Hertz.

Supplied with elastic therapeutic belt with 2 solenoids, power supply, carrying bag and manual (GB, FR, IT, ES).



28296

11 PROGRAMMES		
7 pre-set programmes	3 working freq.+autoscan	
Osteoarthritis	5 Hz	Autoscan
Osteoporosis	10 Hz	
Arthritis	20 Hz	
Fractures		
Articular pain		
Muscle pain		
Anti-inflammatory		

MAG 2000 LOW FREQUENCY, HIGH INTENSITY MAGNETOTHERAPY



28300

Size:

180x110x50 mm

• 28300 MAG 2000 MAGNETOTHERAPY - 2 channels - 300 Gauss 28311

• **28311 MAG 2000 PLUS MAGNETOTHERAPY - 2 channels - 400 Gauss**
Ideal devices for domiciliary and professional magnetotherapy.

35 programmes: 20 pre-set programmes for the treatment of several pathologies, 14 programmes identified by the working frequency (from 1 to 100 Hertz) and an Autoscan programme with continuous frequency variation for the treatment of both hard and soft tissues at the same time.

MAG2000 PLUS has also the possibility to store 10 user memories, choosing the frequency up to 120 Hz, intensity and therapy time: a great possibility for the professional user who need to use a specific treatment for each patient. Possibility to set the intensity of magnetic field for all the programmes up to 300 Gauss (150 Gauss each channel) for MAG 2000 or up to 400 Gauss (200 Gauss each channel) for MAG 2000 Plus to easily treat different body parts through elastic therapeutic belt with 3 solenoids.

Operating power 110-240 V.
Supplied with elastic therapeutic belt with 3 solenoids, couple of professional solenoids (28311 only), power supply, carrying bag and manual (GB, FR, IT, ES). On request DE.

• **28299 ELASTIC THERAPEUTIC BELT - spare**
Belt with cable with 3 solenoids for low frequency treatments.

• **28316 COUPLE OF PROFESSIONAL SOLENOIDS**
Couple of professional solenoids Ø 11 cm for high intensity therapy.



Couple of professional solenoids

35 PROGRAMMES (28300) - 45 PROGRAMMES (28311)			
20 pre-set programmes		14 working freq.+autoscan	
Osteoporosis	Intercostal Contusion	1 Hz	50 Hz
Arthrosis	Lumbalgy	3 Hz	60 Hz
Arthritis	Lumbar pain	5 Hz	70 Hz
Cervical arthrosis	Shoulder arthrosis	10 Hz	80 Hz
Articular pain	Knee arthrosis	15 Hz	90 Hz
Cervical pain	Periarthritis	20 Hz	100 Hz
Sprains	Coxarthrosis	30 Hz	Autoscan
Fractures	Muscular Atrophy	40 Hz	
Epicondylitis	Muscular contracture		
Epitrocleitis	Osteonecrosis		
		10 memories (28311 only)	

OSTEOMAT 2000: MATTRESS FOR LOW FREQUENCY MAGNETOTHERAPY TREATMENTS

• **28307 OSTEOMAT 2000 MATTRESS FOR MAGNETOTHERAPY**
Osteomat has 4 sectors (2 active and 2 passive) linked with velcro straps to create a real mattress.

The two active sectors allow the biostimulation of a wide body part through 6 professional solenoids. The two passive sectors create a planar surface where patient can lay down.

Each active sector can be personalized according to therapeutic needs by choosing solenoids positions.

The basic configuration of Osteomat 2000 stimulates the body zones (shoulders, column, pelvis) that are more affected by bone mass reduction. This is typical of osteoporosis disease. Suitable for MAG 2000 and MAG 2000 PLUS programmes.

Suggested for night therapy during sleep, day therapy in paralyzed patients, active patients that don't tolerate long treatments with therapeutic belt and prefer night therapy.

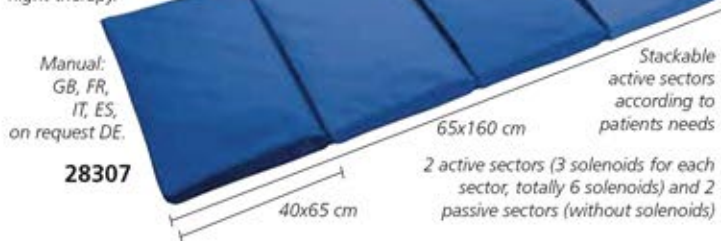

Manual: GB, FR, IT, ES, on request DE.

28307

MT BASE: MAGNETOTHERAPY

• 28321 GIMA MT BASE PLUS - magnetotherapy

Magneto Base Plus + is an ELF low frequency magnetotherapeutic unit designed for domiciliary applications. The most important effects of the magnetic fields are: Antiedemigen / Analgesic / Antiphlogistic / Regenerative and have applications in: traumatology, rheumatology, angiology, neurology, dermatology, endocrinology. The magnetic field produced is impulsive. The internal generator produces square waveform electrical current with frequency varying from 10 to 99 Hz and impulse time varying so to obtain a field's intensity determined from 10 to 80 Gauss. Internal sound sensor of magnetic field and safety system in case of short-circuit. Two transducers can be connected at the same time (the field produced by each transducer is half of the total).

- 28322 PLATE TRANSDUCER 70x120 mm - spare
- 28323 VELCRO ELASTIC BAND 100x8 cm - spare

STANDARD ACCESSORIES

Power cable	1 velcro elastic band 100x8 cm
2 plate transducers 80 gauss - 120x70 mm	ABS carrying case
1 velcro elastic band 60x8 cm	Manual (GB, IT)

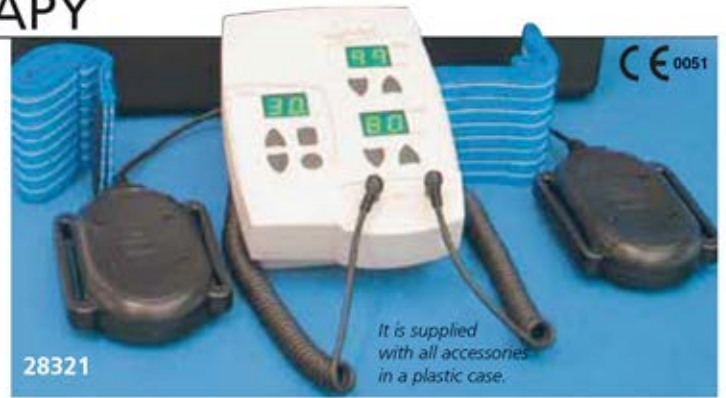

TECHNICAL SPECIFICATIONS

Waveform: square	Intensity of magnetic field: 80 Gauss (8mT)
Max. ratio emission/pause: 50%	Operating voltage: 230V/50-60 Hz
Selectable magnetic field from 10 to 80 Gauss	Size: 193x138x68 mm Weight: 1 kg
Selectable frequency: from 10 to 99 Hz	Safety class: II BF - Norms: EN60601-1 (CEI)

IONO BASE PLUS - GALVANIC IONOPHORESIS

• 28306 IONO BASE - PLUS - 2 channels

Local administration of medicines by ionophoretics, electric osmosis and treatment of hyper hydrosis (sweating disease) and cellulitis. Current generator for hydro galvanization, aesthetic shaping and against cellulitis slight blemish. Microprocessor controlled, with selection of parameters and internal programs. Simple and safe to use, although it maintains characteristics of a professional equipment. Made in Italy.

- 28335 RUBBER ELECTRODES 50x50 mm - box of 10
- 28336 SPONGE BAGS for electrodes 50x50 mm - box of 10

TECHNICAL SPECIFICATIONS

Operating Voltage: 230 V - 50/60 Hz	Size: 138x68x193 mm
Absorbed Max Power: 10 VA	Max Output Current: 20 mA
Safety class: II BF - CE 93/42/EEC. Made in Italy.	

Supplied with ABS case, velcro elastic bands, rubber conductive electrodes 80x120 mm and 50x50 mm and envelopes sponges for electrodes.



INFRARED THERAPY LAMP - 250 W

- 28652 INFRARED THERAPY LAMP - 250 W - desk with table clamp
- 28653 INFRARED THERAPY LAMP - 250 W - trolley

The infrared light relieves the suffering caused by sore muscles and joints ankylosis. The comfortable warmth created by infrared light penetrates deep into the skin, stimulates blood circulation and warms the muscles. While the muscles are relieved, they automatically stretch and relax. At the same time, the blood circulation helps your body get rid of impurities and quickly sends oxygen-rich blood to stressed or aching muscles, causing an effective pain relief. Class II Electric.

- 28654 SPARE BULB - 250 W

Head Ø 21 cm

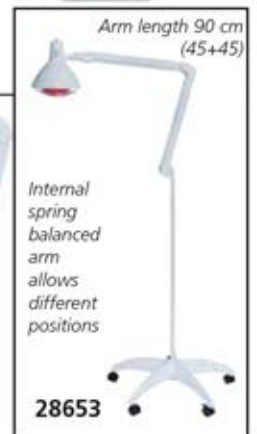

INFRALEX: THERAPEUTIC HEATING DEVICE

- 28650 INFRALEX 230 V - 50/60 Hz
- 28651 SPARE BULB 7.5 W

FDA CE 0434

Infrarex is a modern scientifically electronic therapeutic heating device which provides deep, infrared heat that can penetrate far below the surface of the skin to produce a soothing, comforting effect upon the nerves. It relieves muscular tension, reduce inflammation and provides pain relief without medication for many conditions such as: arthritis, bursitis, sinusitis, tennis elbow, back ache, neuralgia, muscular pains, aches, sprains, and other musculoskeletal aches. Infrarex provides pain relief without medication, you will experience pain relief within 10-15 minutes. No concern for side effects, simple to be used.



MOMERT INFRARED LAMP 100 W

• 28648 MOMERT INFRARED LAMP 100 W

The lamp's deep penetrating infrared heat relaxes the muscles and stimulates the blood circulation. The pleasant heat expands the capillary veins, resulting in a better oxygen and nutrition supply to the tissues. Can be used for rheumatic diseases, allergies, cold diseases, alternative medicine (detoxification), beauty care.

Operating voltage: 230 V - 50 Hz.

- 28649 SPARE BULB - 100 W Philips

Multilanguage manual and box (GB, FR, IT, ES, PT, DE, HU, SK, LV, CZ, EE, PL, RU, BG).



Box size 185x140x225 mm

28648



SMART TENS - EMS

• 28355 SMART TENS

TENS is a therapeutic technique mainly used for analgesic purposes in physiotherapy. Suitable for a wide variety of pain therapies: acute or chronic pain, muscular pain, post-operative pain and also pains caused by pregnancy. It's usually divided according to its action mechanism in tens conventional, tens endorphinic, tens sequential, tens maximum value, tens Burst.

EMS is a stimulating technique activating muscular contractions through electrical impulses.

As in TENS stimulation, impulses are applied to patient through electrodes placed next to the muscles to be treated.

In physiotherapy EMS is used for post-trauma and post-operative muscular rehabilitation and also as a complementary aid in sports activity and aesthetic treatments.

Basic programmes used in TENS treatments together with EMS classic protocols are combined in this product. SMART TENS offers a wide possibility to treat acute and chronic pains (TENS) and muscular strengthening and stimulation (EMS).

Supplied with 2 connection cables for electrodes, 4 pre-gelled electrodes with cable, belt clip, 4xAAA size batteries, user manual (GB, FR, IT, DE, ES) in a carrying bag.

Digital keyboard



CE 0476



28355

On line quick guide on display

TECHNICAL SPECIFICATIONS

- combined electrotherapy unit with 2 independent channels
- compensated biphasic square wave: current quantity from positive pole to negative one is constant to avoid hazardous thermal effect of polarization
- 6 TENS stored programmes
- 5 EMS stored programmes
- 2/120 Hz waveform frequency
- 60 mA maximum intensity
- size: 68x110x31 mm
- 1 TENS free programme
- 1 EMS free programme
- 50/400 µs width impulse
- power supply 4 batteries AAA Size
- weight: 85 g (without batteries)

GIMA TENS - ELECTRICAL MUSCLE STIMULATORS

Size: 128x56x16 mm
LCD size: 48x25.4 mm
Weight: 67 g

Manual: GB, FR, IT, ES, DE, PT, GR, PL

Size: 162x10.7x120 mm
LCD size: 31x37 mm
Weight: 200 g

4 CHANNELS
30 PROGRAMMES

28342



• 28342 GIMA 9 TENS - 2 channels

Pocket TENS with 9 programmes and 2 channels. 9 adjustable intensities.

Relieves muscle pain and stimulates blood circulation.

Frequency: 2-80 Hz.

Supplied in a nylon bag with 2AAA batteries and 4 electrodes.

- 28351 GELLED ELECTRODES 40x40 mm - pack of 4 - spare
- 28343 CABLES - pack of 2 pcs - spare

28365



Manual: GB, FR, IT, ES, PT.

• 28365 GIMA 30 TENS - 4 channels

Portable electrical muscle stimulator with 4 channels and 30 programmes. Backlit LCD display.

Frequency: 2 to 2000 Hz

Supplied in a nylon bag with 4AA batteries and 8 electrodes

- 28366 ELECTRODES - pack of 8 - spare
- 28367 CABLES - pack of 4 pcs - spare
- 28368 AC ADAPTOR - 230V - 50Hz

DISPOSABLE GELLED ELECTRODES FOR ELECTROTHERAPY

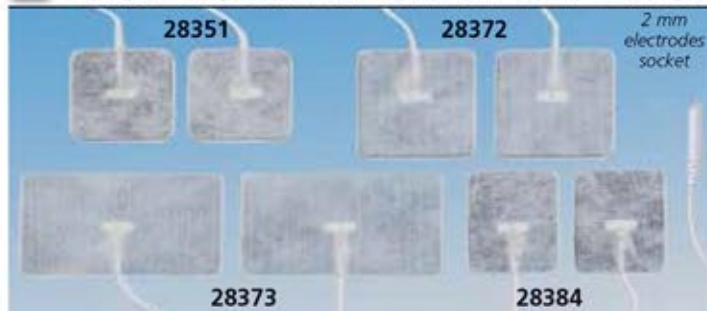

DISPOSABLE GELLED ELECTRODES WITH CABLE - latex free
High material flexibility allows easy application of electrodes on treated areas. Solid gel maintains the electrode adhesion and conductivity unchanged during procedure. The electrodes are equipped with 10 cm long cable, with 2 mm socket.

- 28384 GELLED ELECTRODES with cable 45x35 mm - bag of 4
- 28351 GELLED ELECTRODES with cable 40x40 mm - bag of 4
- 28372 GELLED ELECTRODES with cable 46x47 mm - bag of 4
- 28373 GELLED ELECTRODES with cable 45x80 mm - bag of 4



DISPOSABLE GELLED ELECTRODES AND ADAPTORS - latex free
High material flexibility allows easy application of electrodes on treated areas. Solid gel maintains the electrode adhesion and conductivity unchanged during procedure.

- 28387 GELLED ELECTRODES 45x35 mm - bag of 4
- 28388 GELLED ELECTRODES 46x47 mm - bag of 4
- 28317 GELLED ELECTRODES 45x80 mm - bag of 4
- 28390 2 mm CLIP ADAPTORS - black - box of 10
- 28391 2 mm CLIP ADAPTORS - red - box of 10
- 28392 4 mm CLIP ADAPTORS - black - box of 10
- 28393 4 mm CLIP ADAPTORS - red - box of 10

ADAPTORS



MIO-CARE - 2 CHANNEL TENS

- 28370 MIO-CARE TENS - 20 medical programmes
 - 28376 MIO-CARE FITNESS - 55 programmes (20 medical + 15 beauty + 20 fitness programmes)
 - 28377 MIO-CARE PRO - 63 programmes (14 medical + 15 beauty + 21 fitness + 13 free memories)
 - 2 independent channels stimulator
 - compensated biphasic square wave: avoids hazardous thermic effect of polarization
 - easy to use, digital keyboard
 - remaining therapy time and programmes instruction shown on graphic display
 - internal rechargeable battery pack
 - maximum intensity 200 mA
 - compliance with 93/42/EEC MDD
- Supplied in a carrying bag with 2 connection cables with splitters, user manual (GB, FR, IT, DE, ES), 8 adhesive pads, internal rechargeable battery with battery charger.
- 28372 GELLED ELECTRODES with cable 46x47 mm - bag of 4
 - 28373 GELLED ELECTRODES with cable 45x80 mm - bag of 4

Dimensions:
60x135x19 mm



20 PROGRAMMES
300 APPLICATIONS

55 PROGRAMMES
500 APPLICATIONS

50 PROGRAMMES
13 FREE MEMORIES

14 MEDICAL PROGRAMMES (all)	15 BEAUTY PROGRAMMES (28376, 28377)	20 FITNESS PROGRAMMES (28376, 28377)
Tens conventional (rapid) Tens endorphinic (delayed) Tens maximum values Inflammatory Neck pain/cervicogenic headache Backache/sciatic pain Sprains/bruises +6 MEDICAL PROGRAMMES (28370, 28376) Haematomas Atrophy prevention Atrophy (trophism rehabilitation)	Vascularization Muscle relaxant Hand and wrist pain Plantar stimulation Epicondylitis Epitrochlea Periarthritis Microcurrent Stress incontinence Urgency incontinence	Firming up - upper limbs and trunk Firming up - lower limbs Toning up - upper limbs and trunk Toning up - lower limbs Definition - upper limbs and trunk Definition - lower limbs Modelling Microlifting Lipolysis - abdomen Lipolysis - thighs Lipolysis - glutei and hips Lipolysis - arms Tissue elasticity Capillarization Heaviness in legs Warming up Resistance-upper limbs and trunk Resistance-lower limbs Resistant strength - upper limbs and trunk Resistant strength - lower limbs Basic strength - upper limbs and trunk Basic strength - lower limbs Fast strength - upper limbs and trunk Fast strength - lower limbs Explosive strength - upper limbs and trunk Explosive strength - lower limbs EMS Deep capillarization Muscle recovery Agonist - antagonist Sequent. tonic contract. - upper limbs and trunk Sequential tonic contractions - lower limbs Sequential phasic contract. - upper limbs and trunk Sequential phasic contractions - lower limbs Muscle relaxant Deep massage +1 FITNESS PROGRAMME (28377 only)

I-TECH PHYSIO PROFESSIONAL 2 CHANNELS STIMULATOR

- 28382 I-TECH PHYSIO PROFESSIONAL STIMULATOR
- Professional stimulator with 2 independent channels
- compensated biphasic square wave: current quantity from positive pole to negative one is constant to avoid hazardous thermal effect of polarization
- monophasic square wave
- incontinence and ionophoresis programmes
- denervated treatment
- programmable TENS - EMS memories
- adjustable frequency, width impulse, time, ramp
- remaining therapy time and programmes instructions shown on the LCD
- maximum intensity 200 mApp;
- Can use same gelled electrodes with cable as Mio-Care
- 28381 IONOPHORESIS KIT - spare
- (1 elastic band, 2 silicone conductive electrodes, 2 sponges)

- Supplied in a carrying bag with:
- rechargeable battery and battery charger
 - 1 set of 4 pregelled electrodes 48x48 mm
 - 1 set of 4 pregelled electrodes 50x90 mm
 - 2 silicon conductive electrodes 60x90 mm
 - 2 sponges 70x100 mm
 - 1 elastic belt for electrodes fastening
 - 2 cables, 2 mm connection male plug
 - 4 cable splitter 2 mm male and female plug
- User manual (GB, FR, IT, ES)

Backlit display



Digital easy to use keyboard

PROGRAMMES:
21 NEMS 14 TENS
15 BEAUTY 9 UROLOGY
27 REHABILITATION 13 FREE MEMORIES

MIO IONOTENS, 2 CHANNELS

- 28380 MIO-IONOTENS 37 programmes
- 2 channel stimulator for the customers who need an easy to use device with high output power and a complete list of TENS programmes, rehabilitation programmes and free memories. Portable and easy to use device with backlit display and digital keyboard. It is equipped with internal rechargeable battery (long-lasting) and belt clip. MIO-IONOTENS has 14 TENS programmes, 10 rehabilitation programmes including 3 ionophoresis treatments and 13 free memories (adjustable frequency, width impulse and time). Supplied in a carrying bag, with 2 cables, ionophoresis kit, 1 set of 4 pre-gelled electrodes (41x41 mm), 1 set of 4 pre-gelled electrodes (40x80 mm), belt clip, internal rechargeable battery, battery charger, user manual (GB, FR, IT, ES).
- 28381 IONOPHORESIS KIT - spare
- (1 elastic band, 2 silicone conductive electrodes, 2 sponges)



28380

LATEX-FREE RESISTIVE EXERCISE BANDS

Latex-free bands available in 7 colour-coded levels of resistance and 3 lengths (1.5, 5.5 and 45 m).

These reliable and effective bands are ideal to improve strength, range of motion.

Use of these bands for resistive exercise provides force on the muscles.

Excellent for upper and lower body therapy.

Latex-Free Exercise Bands provide the same benefits as regular bands.

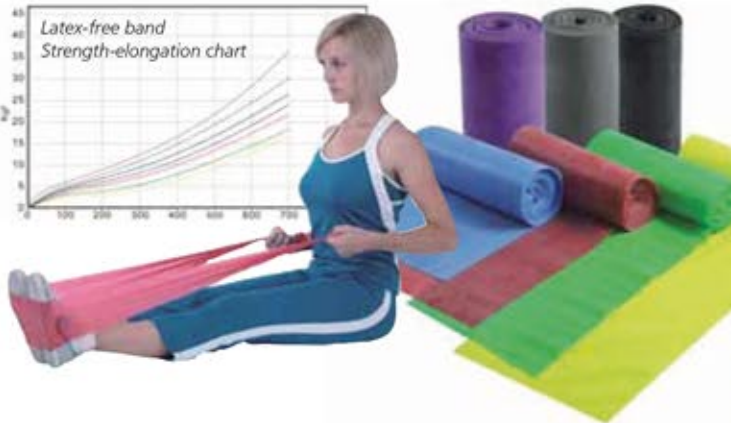
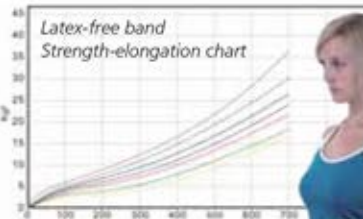

GIMA Code	LATEX FREE EXERCISE BANDS - 1.5 m	
47000	Latex-free band 1.5 m x 14 cm x 0.20 mm	●
47001	Latex-free band 1.5 m x 14 cm x 0.25 mm	●
47002	Latex-free band 1.5 m x 14 cm x 0.30 mm	●
47003	Latex-free band 1.5 m x 14 cm x 0.35 mm	●
47004	Latex-free band 1.5 m x 14 cm x 0.40 mm	●
47007	Set of 5 latex-free bands (1x5 levels) 1.5 m x 14 cm mix	
LATEX FREE BANDS - 5.5 m		
47010	Latex-free band 5.5 m x 14 cm x 0.20 mm	●
47011	Latex-free band 5.5 m x 14 cm x 0.25 mm	●
47012	Latex-free band 5.5 m x 14 cm x 0.30 mm	●
47013	Latex-free band 5.5 m x 14 cm x 0.35 mm	●
47014	Latex-free band 5.5 m x 14 cm x 0.40 mm	●
47015	Latex-free band 5.5 m x 14 cm x 0.50 mm	●
47016	Latex-free band 5.5 m x 14 cm x 0.60 mm	●
LATEX FREE BANDS - 45 m		
47020	Latex-free band 45 m x 14 cm x 0.20 mm	●
47021	Latex-free band 45 m x 14 cm x 0.25 mm	●
47022	Latex-free band 45 m x 14 cm x 0.30 mm	●
47023	Latex-free band 45 m x 14 cm x 0.35 mm	●
47024	Latex-free band 45 m x 14 cm x 0.40 mm	●

0.20 mm
X-Light

0.25 mm
Light

0.30 mm
Medium

0.35 mm
Heavy

0.40 mm
X-Heavy

0.50 mm
XX-Heavy

0.60 mm
XXX-Heavy

LATEX TONE LOOPS

• 47040 SET OF 4 TONE LOOPS

The closed-loop flat band fits comfortable around the upper and lower legs.

It helps to exercise the muscles of hips and legs.

Set includes 4 below loops: each in a different colour-coded level.

Tone loop 18 mm x 58 cm x 1.4 mm

Tone loop 24 mm x 58 cm x 1.4 mm

Tone loop 24 mm x 58 cm x 1.6 mm

Tone loop 30 mm x 58 cm x 1.6 mm

X-Light 1.8 x 58 cm x 1.4 mm
Medium 2.4 x 58 cm x 1.4 mm
Heavy 2.4 x 58 cm x 1.6 mm
X-Heavy 3 x 58 cm x 1.6 mm



EXERCISE MATS

• 47070 EXERCISE MAT 180x60xh 1.6 cm - light blue

• 47080 EXERCISE MAT WITH HANG RING - 180x60xh 1.6 cm - green

Thick mats with sponge-like foam structure offer comfortable feeling. The closed-cell foam structure resists moisture. Easy roll for storage.



This model has 2 rings to allow hang on the wall or on the rack

RESISTIVE EXERCISE TUBING

Tubing is an affordable and convenient training tool which provides effective upper and lower-body workout.

Elastic properties for resistive and strengthening exercise.

Latex exercise tubing



Available also with two pre-attached durable foam covered handles for comfort and grip.

5 colour-coded resistance levels available.



code	LATEX EXERCISE TUBING	Thickness	Strength	Length
47060	Latex tube	1.5 mm	●	25 m
47061	Latex tube	2 mm	●	25 m
47062	Latex tube	2.5 mm	●	25 m
47063	Latex tube	3 mm	●	25 m
47064	Latex tube	3.5 mm	●	25 m

code	LATEX TUBE WITH TPR HANDLES	Strength	Length
47050	Latex tube with TPR handles	●	125 cm
47051	Latex tube with TPR handles	●	125 cm
47052	Latex tube with TPR handles	●	125 cm
47053	Latex tube with TPR handles	●	125 cm
47054	Latex tube with TPR handles	●	125 cm

HAND/FINGER/WRIST EXERCISERS



Ø 36 cm

- 47130 GRIP TRAINER - X-light
 - 47131 GRIP TRAINER - light
 - 47132 GRIP TRAINER - medium
 - 47133 GRIP TRAINER - heavy
 - 47134 GRIP TRAINER - X-heavy
- Releases typing and mousing tension. Improves hand and finger flexibility. Excellent for finger and wrist strengthening and rehabilitation.



- 47170 TPR FLEX BAR - light
 - 47171 TPR FLEX BAR - medium
 - 47172 TPR FLEX BAR - heavy
- Flex bar is a flexible, durable resistance device with ridge surface for enhanced grip during use. It is used to improve grip strength by bending, twisting or vibrating.



- 47160 SET OF 3 FINGER EXERCISERS
- Unique design for rehabilitation, excellent stress-reliever for users. Simply insert fingers into circles and stretch. Multiple resistance level available, set of light, medium and heavy resistance.



- 47180 POWER GRIP - light
 - 47181 POWER GRIP - medium
 - 47182 POWER GRIP - heavy
- Develop finger flexibility, strength and coordination. Increase hand, wrist and forearm strength. Improve the injured finger recovery.



- 47140 SQUEEZE EGG - X-soft
 - 47141 SQUEEZE EGG - soft
 - 47142 SQUEEZE EGG - medium
 - 47143 SQUEEZE EGG - firm
 - 47144 SQUEEZE EGG - X-firm
- These gel-filled eggs offer variable resistance training for hands and fingers. Help grip strengthening and reduce stress.



- 28790 HAND GRIP METER - plastic
- Indicator remains at maximum until reset and is calibrated 0-75 kg. Size 20x15 cm. Sold in a blister. Manual in: GB, FR, IT, ES.

BALANCE AND WEDGE CUSHION



47090



47095

- 47090 BALANCE CUSHION
 - 47095 WEDGE CUSHION
- Non allergic, non toxic air filled cushions made of soft, pliable material free of latex, PVC, phthalates and chloride. Both have two surfaces: smooth and bubbled which provide two kinds of user experience. Great for improving intramuscular coordination as well as balance training ergonomic sitting and rehabilitation.

RESISTANT BALLS

- 47102 BURST RESISTANT BALL - Ø 55 cm
 - 47103 BURST RESISTANT BALL - Ø 65 cm
 - 47104 BURST RESISTANT BALL - Ø 75 cm
- Designed for dynamic workouts that incorporate moderate level of resistance. Deflate slowly if punctured. 300 lb burst resistance level.

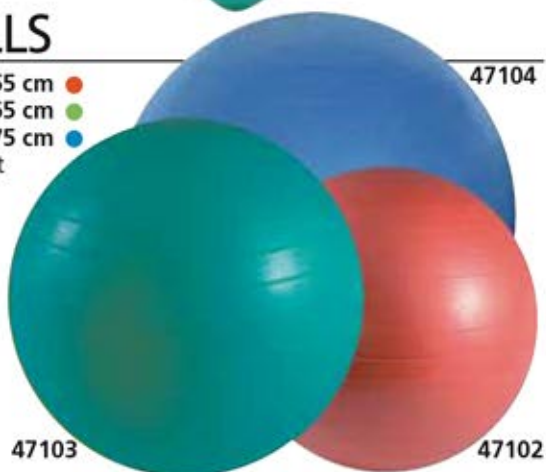

47104

136 kg burst resistance level

47103

47102

MASSAGE BALLS

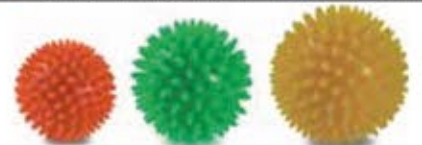

- 47120 MASSAGE BALLS
- Set of 3 massage balls Ø 6, 7, 8 cm



NASAL WASH



28083

28084

- 28083 SINUS C SALINE NASAL SPRAY 20 ml - for children - box of 48
 - 28084 SINUS A NASAL WASH - for adult - bottle 120 ml + 12 saline sachets
- Nasal wash helps to remove the sinus symptoms such as runny nose, nasal dryness and nasal congestion. By performing a nasal wash, you can remove particles such as pollen and dust in order to reduce the mucous membranes inflammation and make it more resistant to allergies.

HUMI-RAINBOW



28070

- 28070 HUMI-RAINBOW HUMIDIFIER A cold-mist ultrasonic humidifier with an attractive design and chromatic 7-led colours change
- 28071 BALSAMIC ESSENCE - pine
- 28072 BALSAMIC ESSENCE - citrus



TECHNICAL SPECIFICATIONS

Power feeding: AC 110-240V / 50-60 Hz
 Max mist output: 280 ml/h
 Water Tank capacity: 2.8 l
 Suitable for room size: min 10, max 25 m²
 Max operating hours (non-stop): 10 hours
 Size (individual box): Ø 19xh 30 cm - Weight: 1.4 kg

VAPINAL INHALER



- 28110 VAPINAL THERMAL WATER INHALER Warm jet mineral water inhaler ideal for home spring water inhalation treatment. It delivers hot humid steam through a nozzle working with the Venturi system and mixing the steam with the principles of thermal water. Equipped with stainless steel boiler working with resistance at 230V-50 Hz. Supplied with polycarbonate ampulla. Made in Italy.
- 28112 VAPINAL AMPULLA - spare part

TECHNICAL SPECIFICATIONS

Capacity: 800 ml
 Steam boiler in stainless steel
 Security valve and thermostat
 Operating voltage: 230 V - 50 Hz - 600 Watt
 Heating time: 5-8 min
 Inhalation time (for 1 l): 12-15 min

ACCESSORIES FOR ANY BRAND OF NEBULIZER

ACCESSORIES FOR NEBULIZER

Gima offers different nebulizer bulbs with their line of accessories, suitable for any brand of nebulizer.

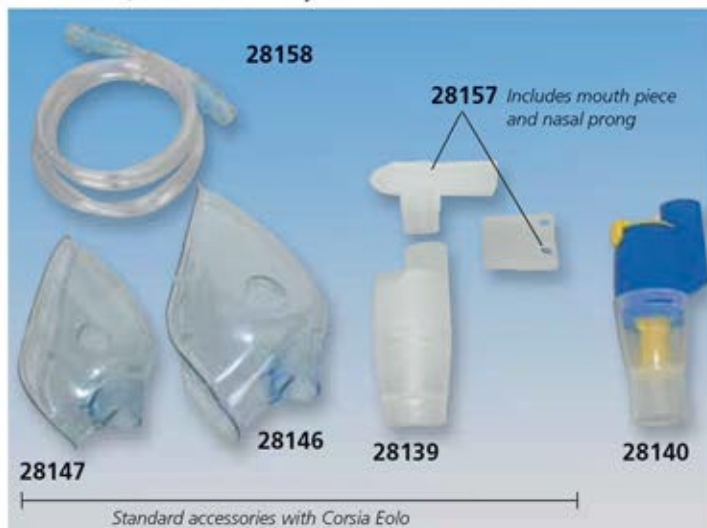

28158

28157 Includes mouth piece and nasal prong

28147

28146

28139

28140

Standard accessories with Corsia, Eolo

code	NEBULIZER ACCESSORIES	To be used with
Standard accessories with Famiglia, Corsia, Eolo		
28158	PVC connection tube - 1m	all nebulizers
28139	Nebulizer bulb	all nebulizers
28146	Facemask - adult* - replaces 28143	bulb 28139/28140
28147	Facemask - paediatry* - replaces 28144	bulb 28139/28140
28157	Mouthpiece - nasal prong	bulb 28139/28140
28138	Nebulizer kit adult and pediatric facemask, pvc-tube, bulb, nasal prong, mouthpiece	all nebulizers
28140	Nebulizer bulb	all nebulizers

*With elastic

FASTERJET BULB

with Valve System

A new designed Jet Nebulizer capable of delivering any medication in a very short time with a high amount of respirable particles. The Valve System makes therapy extremely efficient by reducing the amount of wasted medication while optimizing the output to the patient.

TECHNICAL SPECIFICATIONS FASTERJET

Capacity: 16 ml Neb rate: 0.60 ml/min
 Respirable volume: <5 µm 80%
 Residual volume: 0.8 ml
 MMAD (Mass Median Aerodynamic Diameter): 2.7 µm

Fasterjet bulb:
 For delivering any medication in a very short time

28163 + 28165



28164

28166

28168

28169

28145

code	NEBULIZER ACCESSORIES	To be used with
28163	Fasterjet bulb* with Valve System	all nebulizers
28164	Nebjet bulb** with Double Venturi Effect	all nebulizers
28165	Mouthpiece bi-valve	bulb 28163
28166	Mouthpiece	bulb 28164, 28163
28167	Nasal Prong	bulb 28164, 28163
28168	Facemask-adult***	bulb 28164, 28163
28169	Facemask-pediatry***	bulb 28164, 28163
28145	Filter - spare	28130/1/2/3/4/5

* Standard with Happyneb II, Hospyneb

** Standard with Happyneb I, III, Betaneb

***Without elastic

FAMILY AND PINGOO ULTRASONIC NEBULIZERS



code	ULTRASONIC NEBULIZERS
28106	Family ultrasonic nebulizer
28117	Pingoo ultrasonic nebulizer
28113	Re-chargeable battery Ni MH 12 VDC - Family - optional
28115	Re-chargeable battery Ni MH 12 VDC - Pingoo - optional
28114	Spare Kit: includes adult and paediatric facemask, nasal prong, mouthpiece and tube
28121	Medication cups Family (box of 15 pcs.)
28122	Medication cups Pingoo (box of 15 pcs.)



ULTRASONIC NEBULIZERS

Thanks to the innovative electronic technologies these easy-to-use ultrasonic nebulizers provide a quiet, fast and portable operation with optimal particle size.

Portable: small and lightweight, it allows patients to perform treatments anytime and anywhere.

Optimal particle size: particle size determines the extent to which the medication can be inhaled by the patient into the deep lung tissue.

Approx 90% of particles generated by Family or Pingoo have the optimal 1-5µ (microns) size.

Fast treatment: with its high-efficiency design, it allows a quick treatment time, most within 6 minutes, with limited power consumption.

Low noise level: treatments are not only fast but are virtually silent due to its advanced ultrasonic technology.

Rechargeable battery - optional
8 languages user manual: GB, FR, IT, DE, ES, PT, GR, SA.



TECHNICAL SPECIFICATIONS

Operating voltage: 220-240 V 50/60 Hz Power: 10 W
 Ultrasonic frequency: 2.5 MHz
 Nebulization time: 0.2-0.7 ml/min depending on medication density
 Medication cups capacity: max 8 ml Family, max 4.5 ml Pingoo
 Automatic switch-off
 Particle size: 5 µ (microns) average
 Three programmable flow levels
 Noise level: <40 dB

STANDARD ACCESSORIES

Adult facemask (only Family)
 Paediatric facemask
 Nasal prong, Mouthpiece
 Connection tube
 Medication cups
 Transformer (220-240V-12V DC)
 Carrying bag
 User manual



MESH NEBULIZER

- 28075 MESH NEBULIZER
 - 28078 MESH 2 NEBULIZER since 2018
- Small, handy, lightweight nebulizer for the treatment of respiratory diseases such as asthma, allergies, ...
 Can operate with 2xAA standard batteries or optional AC adaptor 100x240 V.
 - maximizes the benefits of medicine
 - portable, handheld design (only 120 mm height)
 - ultra-low noise and ultra-light design
 - one-button operation for easy use
 - for adult and child: noiseless use and compact design allow to make inhalation even while children are sleeping
 - multilanguage box: GB, IT, FR, ES
 Supplied with cover*, connector*, adult and child mask, mouthpiece, 2xAA batteries, carrying bag, manual (GB, IT, FR, ES)
- 28076 RESPIRATORY ACCESSORY KIT (adult and child mask, mouthpiece and connector) - spare for 28075
 - 28077 AC-DC ADAPTER 100-240 V - optional
 - 28079 RESPIRATORY ACCESSORY KIT (adult and child mask, mouthpiece) - spare for 28078



TECHNICAL SPECIFICATIONS

Power supply: 2xAA batteries or adapter (AC-DC 3V 1A) - 2 W
 Ultrasonic frequency: approximately 140kHz
 Nebulizer rate: ≥0.2ml / min
 Max. / min. liquid volume: 8ml / 0.5ml
 MMAD: approximately 5µm
 Nebulizing head life: 180 hours
 Battery life: 90 minutes with two AA alkaline battery
 Automatic shutdown: automatic shutdown without liquid
 Safety level: Type B, Class II



MYNEB NEBULIZER

- 28073 MYNEB NEBULIZER - piston
- Compact, fast and silent nebulizer. Suitable for the treatment of the respiratory tract diseases, bronchial and asthmatic diseases, allergies. Ideal for nebulizing any medicine, ever oily ones such as cortisones essentials oils, and active ingredients with solid elements (suspensions).
 Supplied with carrying bag, fasterjet bulb, adult and pediatric mask, air tube, mouthpiece and nosepiece. Multilanguage box and manual: GB, FR, IT, ES, DE. Class IIa. Made in Italy.
- 28093 FILTER - spare - box of 3



COMPACT
SILENT

TECHNICAL SPECIFICATIONS

AC adapter: input 100-240 V - 50/60 Hz - 0,6 A
 output 12 V - DC 2A
 Operating cycle: 30/30 min. ON/OFF
 Noise level: 51 dB
 Nebulization rate: 0.45 ml/min with NaCl 0.9%
 Air Flow: 12 l/min
 Max pressure: 165 kPa/1.65 bar
 Particle size: 75% < 5 µm (NaCl 0.9%)
 Size and weight: 132x140x60 mm - 450 g

*Only 28078

HAPPYNEB NEBULIZERS FOR DOMESTIC USE - PISTON

- 28132 HAPPYNEB II NEBULIZER - piston 230V- Faster-Jet
 - 28135 HAPPYNEB III NEBULIZER - piston 230V
- Happyneb stylish and portable piston nebulizer for a quick and efficacious aerosol therapy. Made in Italy. **Reliable, practical and safe.** Noiseless and lubrication free. Unit includes an air filter to be replaced every 70 applications, and handle for easy carrying. It is built in accordance with European Standard EN 60601-1. **5 languages box and manuals: GB, FR, IT, ES, DE**



CE 0434

NEBULIZER TECHNICAL DATA		
	Happyneb III with Nebjet	Happyneb II with Fasterjet
Capacity:	12 ml	16 ml
Respirable volume < 5 µm	75%	80%
MMAD (Mass Media Aerodynamic Diameter)	2.32 µm	2.7 µm
Neb rate	0.45 ml/min	0.60 ml/min
Residual volume	0.7 ml	0.7 ml

STANDARD ACCESSORIES		
Adult and pediatric face mask	Mouthpiece	
Nasal prong	Fasterjet bulb (28132 only)	
Connection tubing	Nebjet bulb (28135 only)	

	TECHNICAL SPECIFICATIONS	
	28132 - HAPPYNEB II	28135 - HAPPYNEB III
Voltage:	230V/50 Hz	
Maximum pressure:	280 kPa	250 kPa
Operating pressure:	110 kPa	90 kPa
Air flow:	15 l/min	14 l/min
Dimensions:	31x22x13 cm	
Weight:	2.3 kg	2 kg
Noise level	58 db	58 db
Temporary use:	Continuous use	30/30 min ON/OFF
Class of risk - norms	IIa - Class II, Type B	

ATOMIZER 2 SPEEDS, PISTON NEBULIZER FOR FAMILY USE

- 28094 ATOMIZER NEBULIZER - 2 speeds
- Piston-type compressor with 2 speeds for family use. With accessory compartment separated from cord compartment for improved hygiene. Made in Italy.
- 28093 FILTER - spare - box of 3

TECHNICAL SPECIFICATIONS	
Operating voltage:	230 V - 50 Hz
Operating cycle:	continuous
Operating pressure:	speed 1: 45 kPa - speed 2: 60 kPa
Air Flow:	speed 1: 8 l/min - speed 2: 11 l/min
Nebulization rate:	speed 1: 0.2 ml/min - speed 2: 0.35 ml/min
Particle size:	80% < 5 µm
Max pressure:	1.85 bar / 185 kPa
Weight:	1.4 kg
Noise level:	56 db
Class of risk: IIa	



STANDARD ACCESSORIES
Nebjet bulb with connector
Adult and child mask
Mouth piece and nose piece
Air tube and 3 air filter



EOLO NEBULIZER - PISTON

- 28097 EOLO NEBULIZER - piston
 - 28091 EOLO NEBULIZER - piston - UK plug
- Innovative, portable, easy to use nebulizer for home use, recommended to nebulize antibiotics and bronchodilator drugs. Plastic body with high thermal insulation. Supplied with adult and pediatric face mask, bulb, mouthpiece, air tubing, air filter. Multilanguage user manual (GB, FR, IT, DE, ES, PT, RU). Made in Italy.
- 28095 FILTER - box of 20 pcs.



157

	28097 EOLO	28102 MISTRAL
Operating voltage:	230V - 50/60Hz - 170VA	230V/50 Hz - 170VA
	110V or 60Hz on request	
Operating pressure:	1.1 bar	1.1 bar
Air flow:	14 l/min	14 l/min
Nebulization rate	0.4 ml/min	0.35 ml/min
Particle size	< 5 µm	< 5 µm
Max Pressure:	2.5 bar	2.5 bar
Dimensions:	22x14.5x12 cm - 1.7 kg	13x8.9x14.6 cm - 1.5 kg
Noise level (EN 13544-1)	55 db	60 db
Class of risk	IIa	IIa
Norms:	insulation class, Type B	insulation class, Type BF
Origin:	Italy	Italy

MISTRAL NEBULIZER - PISTON

- 28102 MISTRAL NEBULIZER - piston
- Compact portable nebulizer for home use. Duty cycle: 20 min on / 40 min off. Supplied with Hi Flo bulb, adult and pediatric mask with string, mouthpiece, nosepiece, air tubing and air filter.
- 28088 FILTER - box of 20



28102

NEBULIZERS FOR PROFESSIONAL AND HOSPITAL USE



28089
Nasaljet is a quick effective nasal irrigation device for rinsing the nasal and rhino-pharyngeal cavities



28090

CONTINUOUS USE COMPRESSOR



28134

CE 0434

Metal box

PROFESSIONAL NEBULIZERS

Piston compressor nebulizers for professional and home care use. They embody all the dictates of modern aerosol therapy techniques. Reliable and simple to use, also by inexperienced users. Manual: GB, FR, IT, DE, ES. Made in Italy.

code	PROFESSIONAL NEBULIZER	Voltage
28134	HOSPYNEB PROFESSIONAL	230 V - 50/60 Hz
28137	HOSPYNEB PROFESSIONAL	110 V - 60 Hz
28090	COMP-A NEB PROFESSIONAL	230 V - 50 Hz
28089	NASALJET	-
28176	COMPRESSOR - spare for 28134	230 V - 50/60 Hz
28145	FILTER - spare	

	TECHNICAL SPECIFICATIONS	
	HOSPYNEB	COMP-A NEB
Operating voltage:	230 V - 50 Hz	110 V - 60 Hz on request 230 V - 60 Hz on request
Size:	28x19x17 cm	19.6x35.7x18.5 cm
Max pressure:	350 kPa (3.5 bar)	250 kPa
Noise level:	60 dBA	55 dBA
Operating pressure:	0-130 kPa (0-1.3 bar)	0-110 kPa
Weight:	4.1 kg	2.5 kg
Air Flow:	15 l/min	
MDD class:	IIa	

STANDARD ACCESSORIES

Fasterjet nebulizer with valve system
Nosepiece irrigation (polypropylene)
Mouthpiece (polypropylene) with valve (silicone)
Adult and child mask (PVC DEHP free)
Air tube (PVC DEHP free) and spare filter.
Nasaljet (only with 28090).



• 28105 CORSIA PROFESSIONAL NEBULIZER - piston

• 28092 CORSIA PROFESSIONAL NEBULIZER - piston

- without manometer
Piston-type compressor nebulizers designed for continuous use. High performance with any type of drug, ideal for intensive hospital and clinic use. Recommended for atomizing antibiotics and bronchodilator drugs. Manufactured with high thermal

CONTINUOUS USE COMPRESSOR



28105

CE 0476

and electric insulation plastic chassis in accordance with the latest European Safety regulations. The oil-free piston compressor has long durability and is equipped with the highly efficient HI-FLO jet nebulizer to guarantee quick and accurate drug delivery. Easy to handle and transport.

• 28104 FILTER - spare - box of 2

TECHNICAL SPECIFICATIONS	
Operating Voltage:	220-230 V - 50/60 Hz
Power consumption:	184 VA
Max pressure:	250 kPa (2.5 bar)
Air flow:	16 l/min
Operating pressure:	130 kPa (1.30 bar)
Operating air flow:	5.2 l/min at 130 kPa
Nebulization rate:	0.50 ml/min with 4 ml solution
MMAD:	3.25 µm GSD: 3.45
Size:	255x190x105 mm Weight: 2.2 kg
Noise level:	approx 57 db Made in Italy

STANDARD ACCESSORIES

HI-FLO Jet bulb Mouthpiece
Adult and child mask Air tube and air filter
Multilanguage user manual: GB, FR, IT, ES, DE, PT



28092

NEBULIZER FOR INTENSIVE HOSPITAL USE

• 28060 CLINIC-AIR NEBULIZER - piston

High performing piston nebulizer for administration of any kind of drug, ideal for intensive hospital and clinical use. Its structure is made of a high thermal and electrical insulated plastic in accordance to safety European standards. Long life dry piston compressor and bulb with a valve system that allows to adjust the nebulization speed.

Class IIa - Insulation class (EN60601-1): Class II Type B.

TECHNICAL SPECIFICATIONS

Operating Voltage: 230 V - 50/60 Hz
Max pressure: 250 kPa (2.5 bar)
Operating pressure: 130 kPa (1.30 bar)
Nebulization rate:
Power consumption: 110 VA
Air flow: 16 l/min
Operating air flow: 5.2 l/min at 130 kPa
Made in Italy

- 28062 BULB - spare
- 28063 FACE MASK - adult - spare
- 28064 FACE MASK - pediatric - spare
- 28104 FILTER - spare - box of 2

STANDARD ACCESSORIES

Bulb with valve
Mouthpiece
Adult and child mask
Air tube and air filter
Multilanguage user manual: GB, FR, IT, ES, DE



28060

MEDICAL GRADE SILICONE TUBES FOR EXTERNAL USE



SILICONE TUBES for external medical use - silicone 100% Suitable for autoclaving (135°C - 2.2-2.5 bar) and Gamma Sterilization. Resistant to hot air up to 200°C. Infra-red vulcanization. Hours treatment at 200°C temperature in special oven. Anti-adherent, avoid incrustation and coagulation. Medical Grade - Transparent - Odourless

TECHNICAL SPECIFICATIONS

Raw material: HTV-R-401/60 S - WACKER (D)
 Colour: translucent
 Hardness: 60° ±5% Shore - DIN 53505
 Density: 1.17 g/ccm - DIN 53479A
 Tensility: 10.8 N/mm² - DIN 53504 S1
 Stretch: 490/530% - DIN 53504S1
 Tear resistance: 34-35 N/mm - ASTM D 624 B
 Reverse pull elasticity: 51% - DIN 53512
 Compression set: (22h/175°C): 30-15% - DIN 53517

Made in European Union according to: US PHARMACOPEIA XXI
 EUROPEAN PHARMACOPEIA DIN 58367 - DIN 58362 - DIN 13098- FDA 177.2600 - BGA XV part A and B - BGA IX part B

code	Internal diameter x external diameter	Thickness mm	Minimum order
25450	1x3 mm	1 mm	roll of 100 m
25451	2x4 mm	1 mm	roll of 100 m
25452	3x5 mm	1 mm	roll of 100 m
25453	4x6 mm	1 mm	roll of 100 m
25455	6x8 mm	1 mm	roll of 30 m
25458	3x6 mm	1.5 mm	roll of 30 m
25459	4x7 mm	1.5 mm	roll of 30 m
25460	5x8 mm	1.5 mm	roll of 30 m
25461	6x9 mm	1.5 mm	roll of 30 m
25462	7x10 mm	1.5 mm	roll of 30 m
25466	4x8 mm	2 mm	roll of 30 m
25467	5x9 mm	2 mm	roll of 30 m
25468	6x10 mm	2 mm	roll of 30 m
25469	8x12 mm	2 mm	roll of 30 m
25470	10x14 mm	2 mm	roll of 30 m
25474	5x10 mm	2.5 mm	roll of 30 m
25475	7x12 mm	2.5 mm	roll of 30 m
25476	8x13 mm	2.5 mm	roll of 30 m
25477	10x15 mm	2.5 mm	roll of 30 m
25480	6x12 mm	3 mm	roll of 30 m
25481	7x13 mm	3 mm	roll of 30 m
25482	8x14 mm	3 mm	roll of 30 m
25483	9x15 mm	3 mm	roll of 30 m
25484	10x16 mm	3 mm	roll of 30 m
25485	12x18 mm	3 mm	roll of 30 m
25488	8x15 mm	3.5 mm	roll of 30 m
25491	10x20 mm	5 mm	roll of 30 m
25495		made to order	500 m

MADE TO ORDER SILICONE TUBES
 We can manufacture any size
 (minimum order 500 m - delivery 30 days)

ACCESSORIES FOR ANY SUCTION ASPIRATOR



code	STAINLESS STEEL ASPIRATION TUBES
28262	S/S Bierer Aspiration tube Ø 8 mm
28264	S/S Bierer Aspiration tube Ø 12 mm
28260	Set of 7 uterine aspiration cannulas for abortion: 4 cannulas with side suction end (Ø 5, 6, 8, 9 mm), 3 cannulas with front suction end (Ø 7, 10, 11 mm) and one handle

- SILICONE VACUUM SUCTION
See page 172
- SUCTION CATHETER
See page 43
- S/S FRAIZER SUCTION CANNULA
See page 34
- S/S ROSEN SUCTION CANNULA
See page 34
- S/S NOVAK SUCTION CANNULA
See page 33

BREAST PUMP - MAMILAT GIMA

- **28148 MAMILAT - BREAST PUMP - 230 V - 50 Hz**
Easily transportable from one maternity ward to another, or for use at home. To be used for mother's milk suction. Made of highly heat-resistant, electrically insulated plastic material in conformity with the latest European safety standards. Supplied with 2 polycarbonate milk bottles (150 cc and 250 cc) antibacterial and hydrofobic filter, set of tubes 6x10 mm, breast shield, PVC air tube. Suction adjustment knob. Working time: 20 minutes ON, 40 OFF.
- **28229 HYDROPHOBIC ANTIBACTERIAL FILTER - spare**
- **28149 SPARE KIT**
Includes two plastic bottles (125 cc and 250 cc) nipple shield, filter and tubes.

TECHNICAL SPECIFICATIONS

Regulator for suction intensity - max suction -0.33 bar
 Operating voltage: 220-230 V - 50/60 Hz - available on request 110 V - 60 Hz
 Max flow (air litres/min): 14 l/min
 Power consumption: 184 VA
 Size: 235x190x165 mm Weight: 2.2 kg
 Norms: CEI 62-5 (IEC601-1). Made in Italy

Supplied with anti-bacterial filter

5 languages manual:
 IT, GB, ES, FR, DE.



RES-Q-VAC FILTERED HAND SUCTION



• 28124 RES-Q-VAC (FILTERED) SUCTION

This lightweight and hand held suction unit requires no batteries or electricity and yet provides powerful suction whenever and wherever you need it.

It offers ultimate safety and ease of use for the professional and fits easily into any emergency bag or ambulance.

Key Features:

- portable Hand Powered Suction - one hand operation
- hospital suction level performance >600mmHg
- always ready to go, no set up required, no batteries to recharge
- patented 0.22 equivalent micron filter for ultimate infection control
- full stop protection filter prevent fluid overflow
- easy snap on replacement canister sets with Adult and Child catheters
- each unit 100% tested for reliability



Kit includes: Res-q-Vac pump, canister 300 ml with filter, soft cannula Ø 12.7 mm x 20.3 cm length

• **28128 SPARE ADULT KIT - with filter**
Includes canister 300 ml and wide soft adult style yankauer. Disposable.

• **28129 SPARE PEDIATRIC KIT - with filter**
Includes canister 300 ml and 2 pediatric catheters with different length: 356 mm for paediatric and 88.9 mm for neonatal applications. Disposable.



28124

Jar 300 ml

TECHNICAL SPECIFICATIONS

Weight: 143 g
Size: 114x180x55 mm
Max vacuum: > 600 mmHg
Min. vacuum after 2 activations: > 400 mmHg
Volume per stroke: 30 ml
Capacity before full: 290 ml
Inner Ø of adult catheter: 9.53 mm
Length of adult catheter: 272 mm
Pump is suitable for cold or ETO sterilization

MEET OSHA regulations



HAND/FOOT/KNEE SUCTION PUMP

• 28220 TOBI MANUALE - manual suction aspirator

Independent of any power source, Tobi Manuale is simple to operate pressing pedal by foot, hand or knee.

It is used to clear patient's airways safely and efficiently, anytime, anywhere. Precision and solidly built to assure long service life. Polycarbonate suction bottle with capacity 400 cc, autoclavable at 120°C and spill-over protection.

Bacterial filter included.

Multilanguage user manual: GB, FR, IT, DE, ES.

• 28219 BOTTLE 0.4 l - spare

• 28229 HYDROPHOBIC ANTIBACTERIAL FILTER - spare



28220

Jar 400 ml

TECHNICAL SPECIFICATIONS

Weight: 1.2 kg Max suction -0.40 bar Bottle capacity: 400 cc
Size: 225x165x85 mm Suction power: 22 l/min Made in Italy

HAND SUCTION PUMP

• 28180 HAND SUCTION UNIT

Designed to provide quick and effective pharyngeal and tracheal suction for emergency use.

The adjustable stroke knob provides different suction pressure.

Supplied with 250 ml bottle and 2 sterile adult cannulas 26 and 40 cm

• **28181 SPARE ADULT KIT**
Includes 250 ml bottle and 2 sterile adult cannulas 26 and 40 cm.



Jar 250 ml

Supplied with multilanguage box and manual: GB, FR, IT, ES, DE, PT, PL, GR, Arab.

TECHNICAL SPECIFICATIONS

Max vacuum: -450 mmHg Weight: 260 g
Peak free airflow: >20 l/min Size: 185x70x168 mm
External diameter of catheter connection: 13.35 and 8.67 mm

SPENCER JET COMPACT 300D PORTABLE SUCTION UNIT

• 28177 JET COMPACT PORTABLE SUCTION UNIT

Extremely compact suction device to be used to remove fluids from the airway or respiratory support system. The device creates a negative pressure that draws fluids through disposable tubing that is connected to the collection container.

Easy view of the setted vacuum thanks to the LED indicators.

Classification ISO: high vacuum / high flow. Supplied with 12 V power cable, battery, disposable container with filter, disposable patient tube.

• 28178 DISPOSABLE CONTAINER 300 ml with filter

• 28179 POWER ADAPTER



Class IIa Medical Device according to Dir. 93/42/CEE

28177

TECHNICAL SPECIFICATIONS

Dimensions:	245x70x185 mm	IP grade	IP 12
Weight:	1.60 kg	Battery:	12 V DC NI-MH
Vacuum range:	from 50 to 550 mmHg	Battery operative time:	
Flow (free flow):	32 l/min		30 min ON, 30 min OFF
Noise level:	70 dB	Battery recharging time:	5 h
Electrical connector requirement:	100-240 VAC 47-63 Hz	Container capacity:	300 ml
	0.75 A max: 12 VDC	Patient tube length:	1 m

MINIASPEED BATTERY EVO PROFESSIONAL SUCTION ASPIRATORS

- 28282 MINIASPEED EVO BATTERY SUCTION - 1 l
 - 28283 MINIASPEED EVO BATTERY SUCTION - 1 l for ambulance
 - 28284 MINIASPEED EVO BATTERY SUCTION - 2 l
- Professional portable high flow - high vacuum aspirators with integrated rechargeable batteries. It works at 12 V power supply with rechargeable batteries or directly by mains supply, continuously at 110-230 V while recharging batteries. Up to 45 minutes of autonomy with fully charged battery. Made in Italy.
- 25480 SILICONE TUBE 6x12 mm - roll of 30 m
 - 28254 ADAPTER FOR CATHETER
 - 28255 HYDROPHOBIC 99% BACTERIAL FILTER
 - 28258 AUTOCLAVABLE JAR 1000 ml (with cover)
 - 28259 DISPOSABLE SUCTION LINER
 - 28294 AUTOCLAVABLE JAR 2,000 ml (with cover)



TECHNICAL SPECIFICATIONS	
Operating voltage:	with battery DC 12 V with power supply 100÷240 V - 50/60 Hz - 14 VDC 4,28A
Power consumption:	max 50 W
Size:	134x378xh 263 mm Weight: 4.7 kg (5 kg version for ambulance)
Bottle capacity:	1,000 or 2,000 ml
Flow:	30 air litres/min
Sound level:	65 dBA at 1 m
Operating cycles:	continuous (45 minutes battery autonomy)
MAX vacuum:	0 ± 85 kPa
Internal battery:	12 VDC 4A h lead hermetic
Battery autonomy:	about 45 minutes, recharging time approx 6 hours
Norms:	MDD 93/42/EEC (Class IIa - annex IX) EN60601-1(IEC 60601-1) / EN60601-1-2 (IEC 60601-1-2) UNI EN ISO 10079-1/ UNI CEI EN ISO 14971 Degree of protection against ingress of liquids: IP34d (IEC 529) Class II - Type B

STANDARD ACCESSORIES	
Autoclavable 1 or 2 l jar with safety valve	Power supply cord - 2 m
Sterile disposable cannula CH14	Shoulder carrying bag
Sterile disposable manual regulator	Multivoltage battery charger
Disposable silicone liner 1 l (28282-3 only)	Silicone tubing set Ø 6x12 mm
2 bacterial hydrophobic filters	Support bracket for ambulance (only 28283)
Cigarette lighter power cord (28282, 28284 only)	User manual: GB, IT, FR, DE, ES

SUPERVEGA EVO BATTERY AMBULANCE ASPIRATOR

- 28182 SUPERVEGA EVO AMBULANCE BATTERY ASPIRATOR
 - 28183 SUPERVEGA EVO BATTERY ASPIRATOR
- Supervega Evo is an electric medical device for the nasal, oral and tracheal aspiration of body fluids in children or adults. Two or three options of operation: by 100-240V power feeding (28183 only), 12 V car adapter or internal rechargeable battery. Large LCD for clear reading of vacuum values along with soft keys for vacuum adjustment increase the accuracy of aspiration. Smart operation thanks to the combination of the lightweight lithium-ion battery with the innovating FEEDBACK system that controls and manages the power of aspiration, providing a long autonomy of the battery and quiet noise level during operation. The PROXIMITY function to switch ON or OFF the device without touch prevents and avoids cross-contamination in-between patients. Equipped with a long-life brushless motor eliminating any type of smell and coal residuals. Various options of jar: standard autoclavable polycarbonate (121°C), optional FLOVAC® disposable liners or APEC® that can resist up to 143°C, see at page 163. Complies with EN 60601- 1-11 only 28183 "for use in the home healthcare environment" and carries IP21 degree of protection. Made in Italy.



TECHNICAL SPECIFICATIONS	
Motor:	Oil-less and maintenance-free piston pump
Power:	Internal rechargeable Lithium battery (14.8 V - 5.2 A) - Autonomy 70 min Car-ambulance adapter (12 V - 4 A) - only 28183 AC/DC adapter 110-230 V, 50-60 Hz - only 28183 Recharge from support bracket - only 28182
Max vacuum (adjustable):	-0.75 Bar; -75 kPa; -563 mmHg
Max free air flow rate:	26 l/m Size: 35x19x15 cm Weight: 2.7 kg
Duty cycle:	non stop operation (by mains or 12 V only)

STANDARD ACCESSORIES	
Polycarbonate jar 1,000 ml with overflow valve system	Antibacterial filter
Silicone tube set with conical connector	Suction catheter
Universal power adaptor (100-240V - 50/60 Hz) (only 28183)	12V car adapter (only 28183)
Support bracket for ambulance 20x16x16 cm (only 28182)	Carrying bag (only 28182)
User Manual GB, FR, IT, DE, ES.	

SUPER VEGA BATTERY SUCTION ASPIRATOR ON TROLLEY

- 28193 SUPER VEGA BATTERY on trolley - suction 2x2 l
- Portable suction unit for the aspiration of body liquids, oral, nasal and tracheal aspiration in adults or children. For professional use and with a powerful aspiration of max 36 l/min. It comes with double collection jars and on a stand with five castors for easy transport. Two different working options: AC/DC adapter, rechargeable battery make it a versatile suction unit approved for NON-STOP operation without overheating. Provided with visual and acoustic alarm indicating low battery level, vacuum-meter (bar & kPa) and vacuum regulator.



TECHNICAL SPECIFICATIONS					
Size - Weight:	32x30xh 99 cm - 7.9 kg	Battery autonomy:	60 min	Recharging:	240 min
Operating voltage:	100-240 V - 50/60 Hz	Flow:	36 air litres/minute	Temporary use:	120 on - 60 off
Internal rechargeable Pb battery:	12V - 4A	User manual:	GB, FR, DE, IT, ES	Made in Italy	

BATTERY SUCTION ASPIRATORS

- 28243 SUPER VEGA BATTERY - plastic case - 16 l/min.
- 28190 SUPER VEGA BATTERY - plastic case - 36 l/min.
- 28213 TROLLEY FOR SUPER VEGA
- 28242 BATTERY FOR SUPER VEGA/TOBI (28243'/28240) - spare
- 28251 BATTERY FOR SUPER VEGA (28190/28243'') - spare

*Up to S.N. 2141 (3 LEDs)

**Since S.N. 3000 (1 LED)

With incorporated rechargeable batteries. It can operate at 12 V power supply at rechargeable batteries and, thanks to an electronic system, at 230 V while recharging batteries.

Autonomy: approx 45-50 min (28243), 60 min (28190)

Recharging time: 120-150 minutes.

Max suction: -0.75 bar (28243) -0.80 bar (28190)

Suction power: 16 or 36 air litres/min

It has unbreakable 1,000 ml standard bottle (2,000 ml optional) autoclavable at 120°C with safety float control valve to prevent overflow.



TECHNICAL SPECIFICATIONS SUPER VEGA

Operating Voltage: 220-230 V - 50/60 Hz AC - 12 V DC (28243)
100-240 V - 50/60 Hz (28190)

Size: 350x210x180 mm Weight: 4.9 kg

Max suction -0.75 bar (563 mm/Hg) (28243), -0.80 bar (28190)

Suction power: 16 air litres/min (28243), 36 air litres/min (28190)

Norms: IEC 601-1 - Class II Type B. Made in Italy

STANDARD ACCESSORIES

- | | |
|------------------------------------|--------------------------------------|
| Bottle 1 l - autoclavable at 120°C | AC/DC universal adapter |
| Silicone tubing set | Anti-bacterial filter |
| Suction catheter | Cable to recharge batteries from car |
| User manual (GB, IT, FR, DE, ES) | |

- 28206 MINI ASPEED BATTERY PRO - metal case - 30 l/min
- High vacuum portable medical device for professional surgical aspiration.

- it can operate at 12 V (car) power supply, rechargeable batteries or directly by mains supply

- its two cylinders electro-compressor ensures high performances and long life

- up to 45 min. of autonomy with fully charged battery

- with 99% antibacterial hydrophobic filter

- equipped with autoclavable jar with safety valve, disposable suction liner and carrying case.

- 25480 SILICONE TUBE 6x12 mm - roll of 30 m

- 28254 ADAPTOR FOR CATHETER

- 28255 HYDROPHOBIC 99% BACTERIAL FILTER

- 28258 AUTOCLAVABLE JAR 1000 ml (with cover)

- 28259 DISPOSABLE SUCTION LINER

Disposable suction liner inside autoclavable jar

TECHNICAL SPECIFICATIONS MINI ASPEED

Operating Voltage: 100-240 V 50/60 Hz AC - 14 V DC 4.28 A

Size: 370x100x240 mm Weight: 5.8 kg (include kit)

Max suction: - 0.85 bar

Suction power: 30 air litres/min.

Sound level: 65 db

Norms: MDD 93/42/ECC (class IIa - annex IX)

IEC 60601-1, UNI ENISO 10079-1 Made in Italy

STANDARD ACCESSORIES

- | | |
|--|-----------------------------------|
| Autoclavable jar 1000 cc with safety valve | Anti-bacterial hydrophobic filter |
| Silicone tubing set Ø 6x12 mm | Multivoltage battery charger |
| Disposable suction liner | Cigarette lighter power cord. |
| Sterile cannula | Shoulder carrying bag |
| | User manual (GB and IT) |

28258 + 28259



SUPERVEGA SUCTION ASPIRATOR ON TROLLEY

CE 0476

Vacuum indicator
Max suction:
600 mm Hg - 0.80 bar

Silicone tubing
8x14 mm

Adjustable suction knob

Fixed height
75 cm

28191

Multilanguage user manual:
GB, FR, IT, DE, ES

- 28191 SUPER VEGA on trolley - suction 2x2 l jar
 - 28192 SUPER VEGA on trolley - suction 2x2 l jar with footswitch
- Continuously adjustable vacuum, with indicator. Silicone connection tube. 2 jars 2 litres, made of sterilizable polycarbonate (autoclavable at 120°C). Working time: 120 min ON, 60 min. OFF. Suction power: 40 air litres/min. Steel painted frame, fitted with 5 star base. Norms CEI 62-5 (IEC 601-1) - Class II - Type B
- 28239 HYDROPHOBIC 99% BACTERIAL FILTER
 - 25482 SILICONE TUBE - 8x14 mm - roll of 30 m

TECHNICAL SPECIFICATIONS

Size: 32x30xh 90 cm Weight 6.2 kg
Operating voltage: 220-230 V - 50/60 Hz; other on request
Power consumption: 110 VA
Maximum suction: -0.80 bar (600 mm Hg)
Flow: 40 air litres/minute
Operating cycle: continuous
Norms CEI 62-5 (IEC 601-1) - CE 93/42 EEC
User manual (GB, FR, DE, IT, ES)
Made in Italy



VEGA SUCTION UNITS, HIGH VACUUM, LOW AND HIGH FLOW



**HIGH VACUUM
HIGH FLOW**

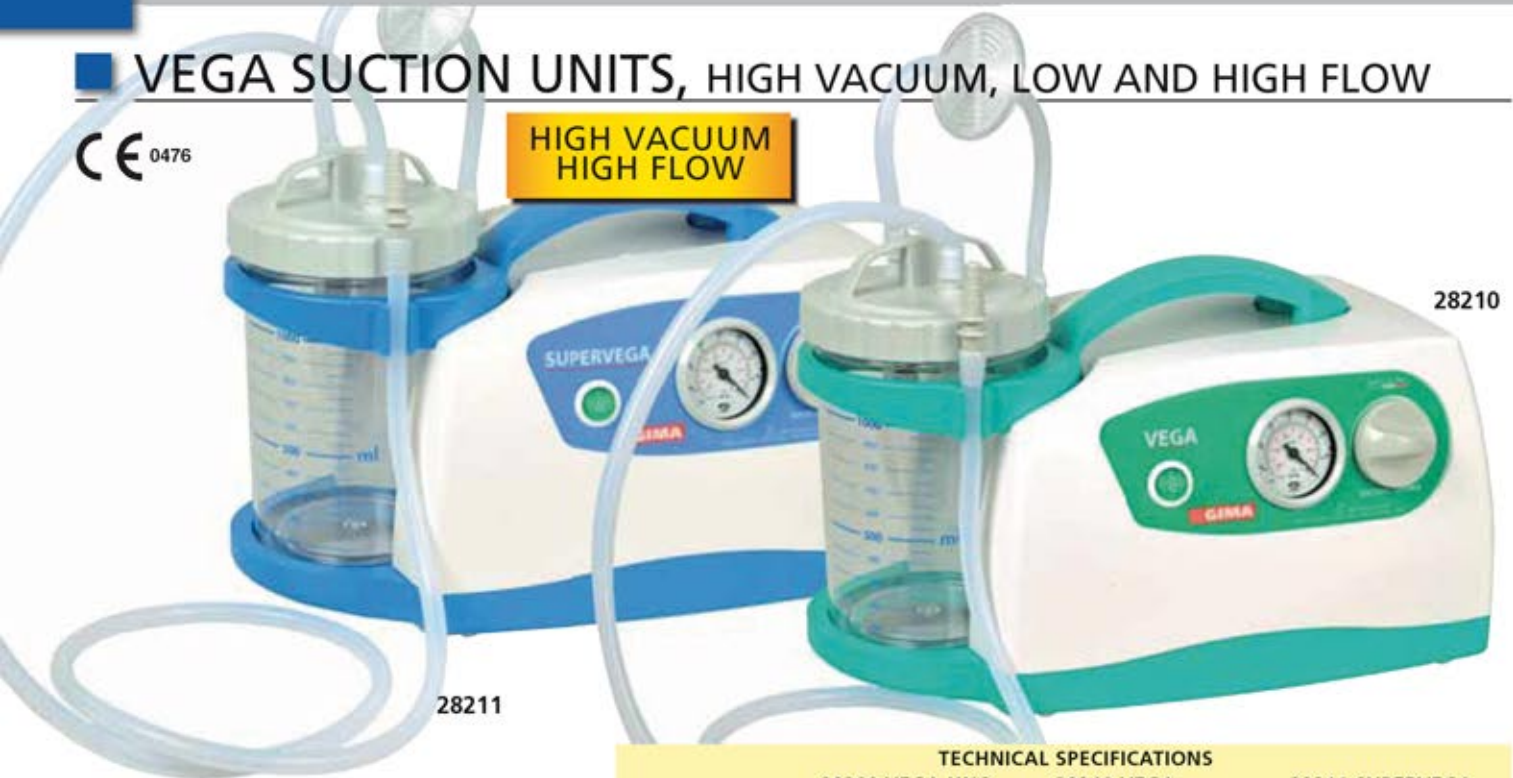

VEGA SUCTION UNITS

A line of stylish, compact and reliable aspirators for small surgery. Silent, high flow and maintenance - free pumps allow long product life and durability. Recommended for nasal aspiration, oral aspiration, tracheal aspiration of body liquids (mucus, catarrh or blood) in adults or children. Equipped with vacuum regulator continuously adjustable, vacuum indicator, unbreakable 1,000 ml or 2,000 ml bottle, autoclavable at 121°C, with safety float control valve to prevent overflow. Optional bottle autoclavable at 134°C. Manufactured in electric and thermal insulated plastic body.

Autoclavable and disposable collection system: In addition to standard autoclavable jar is available a disposable collection system composed by a rigid reusable container and a polyethylene disposable liner with cover, hermetically sealed, and hydrophobic, antireflux, bacterial filter operating as an overflow valve. Made in Italy.

TECHNICAL SPECIFICATIONS			
	28209 VEGA UNO	28210 VEGA	28211 SUPERVEGA
Operating Voltage:	220-230 V - 50/60 Hz 110 V - 60 Hz (on request)	220-230 V - 50/60 Hz 110 V - 60 Hz (on request)	220-230 V - 50/60 Hz or 110 V - 60 Hz
Power consumption:	184 W	184 W	106 W
Bottle capacity:	1,000 ml	1,000 ml	1,000 ml or 2,000 ml
Flow (air litres/min):	15 l/min	16 l/min	40 l/min
Max suction:	-0.75 bar (563 mm/Hg)	-0.75 bar (563mm/Hg)	-0.80 bar (600mm/Hg)
Operating cycle:	continuous	continuous	continuous
Size:	25x19x16.5 cm	35x21x18 cm	35x21x18 cm
Weight:	2.2 kg	2.5 kg	3.6 kg
Norms:	93/42/ECC	93/42/ECC	93/42/ECC

code	VEGA SUCTION ASPIRATOR	Operating power	Flow
28209	Vega Uno	220-230 V - 50/60 Hz	15 l/m
28210	Vega	220-230 V - 50/60 Hz	16 l/m
28211	Super Vega 1l	220-230 V - 50/60 Hz	40 l/m
28212	Super Vega 2l	220-230 V - 50/60 Hz	40 l/m
28189	Super Vega 1l	110 V - 60 Hz	40 l/m



1 l polycarbonate autoclavable jar with overflow safety valve

28252 Adaptor to connect catheter to silicone tube

STANDARD ACCESSORIES

- Autoclavable jar (1 or 2 l) with overflow valve system
- Antibacterial and hydrophobic filter
- Set of silicone tubes 6x10 mm
- Conical connector for probes
- 6 languages user manual (GB, FR, IT, DE, ES, PT) **28229**



code	SPARE ACCESSORIES FOR VEGA AND TOBI LINE
28229	Hydrophobic, 99% antibacterial filter
28226	121°C autoclavable jar 1 l with cover and overflow system
28236	121°C autoclavable jar 2 l with cover and overflow system
28227	Cover and overflow valve system for 28226 and 28236
28185	134°C autoclavable jar 1 l with cover and overflow system
28186	134°C autoclavable jar 2 l with cover and overflow system
28184	Cover and overflow valve system for 28185 and 28186
28271	Disposable liner 1 l (cover + bag)
28270	Container for disposable liner 1 l
28268	Disposable liner 1 l (cover + bag) - box of 50
28273	Disposable liner 2 l (cover + bag)
28269	Disposable liner 2 l (cover + bag) - box of 50
28272	Container for disposable liner 2 l Ø 13 cm top, 9.5 cm bottom
25468	Silicone tube 6x10 mm - roll of 30 m
28252	Adaptor to connect catheter to silicone tube
	Suction catheter - see at page 43
28213	Trolley for Vega and Super Vega (not for Vega Uno)
28276	Vacuum indicator for Vega and Super Vega (not for Vega Uno)

PROFESSIONAL ASPIRATORS - HIGH VACUUM



28280-1

CE 0434
EN ISO 10079-1
Class I
Type B



28244-6

1 l Autoclavable Jar

ASPEED PROFESSIONAL SURGICAL ASPIRATORS
Piston-type continuous cycle electric aspirators give high performance and great durability. Equipped with a protective thermal cut-out relay. They require no maintenance or lubrication. A motor-protector cap totally prevents aspirated

liquids or secretions from reaching and damaging the vacuum pump. Ideal for clinical use. Made in Italy.

code	ASPEED ASPIRATORS	Power	Pump	Case
28244	Aspeed 15 l	230 V	single	metal
28245	Aspeed 22 l	230 V	double	metal
28246	Aspeed 22 l	110 V	double	metal
28280	Aspeed 2 15 l	230 V	single	plastic
28281	Aspeed 2 22 l	230 V	double	plastic

code	ACCESSORIES AND SPARES FOR ASPEED
28255	Hydrophobic 99% bacterial filter
28258	Autoclavable jar 1l with cover
28259	Disposable suction liner
25480	Silicone tube 6x12 mm - roll of 30 m
28254	Adaptor to connect catheter to silicone tube
28261	Adaptor kit to use jar 1l (28258) with ASPEED manufactured before 2007

STANDARD ACCESSORIES
Autoclavable polycarbonate jar 1,000 cc with safety valve (overflow protection)
Disposable suction liner 1 l
99% Antibacterial hydrophobic filter
Sterile disposable cannula
Sterile manual flow regulator
Set of atoxic sterilizable silicone tubes
Power Cable
User Manual GB, FR, IT, DE, ES

	TECHNICAL SPECIFICATIONS			
	ASPEED 28244		ASPEED 2 28281	
Operating voltage:	230 V-50 Hz		230 V - 50/60 Hz	
	110-60 Hz		other voltage on request	
Bottle capacity:	1 l	1 l	1 l	1 l
High vacuum:	low flow	low flow	low flow	high flow
Air flow:	15 l/min	22 l/min	15 l/min	22 l/min
Adjustable vacuum level:	0 ÷ -0.85 bar (0 ÷ -85 kPa)			
Weight:	3.5 kg	4.5 kg	2.5 kg	3.2 kg
Case material:	metal		plastic	
Noise level:	55 dBA	65 dBA	55 dBA	55 dBA



28258 Autoclavable Jar, h 19.2 cm Ø 10 cm top, 9.7 cm base

28259 Disposable suction liner

SUCTION ASPIRATORS HIGH VACUUM, LOW AND HIGH FLOW

- 28222 TOBI - suction aspirator 220-230 V - 50/60 Hz
- 28224 SUPER TOBI - suction aspirator 220-230 V - 50/60 Hz

Portable suction aspirators, ideal for tracheotomy and small surgery. Vacuum continuously adjustable with vacuum indicator. Have unbreakable 1,000 ml standard bottle (2,000 ml optional) autoclavable at 120°C with safety float control valve to prevent overflow. Silicone connection tube. ABS plastic case. Made in Italy



28222

28224

Silicone tube 6x10 mm (see page 159)

Adaptor for catheter (code 28252)

STANDARD ACCESSORIES		
	Tobi	Super Tobi
Bottle 1,000 ml with cover	1	1
Antibacterial Filter	1	1
Suction catheter	1	1
Silicon Tube set	1	1
User manual GB, FR, IT, DE, ES	1	1

TECHNICAL SPECIFICATIONS		
	28222 Tobi	28224 Super Tobi
Operating voltage:	220-230 V - 50/60 Hz	220-230 V - 50/60 Hz
Power consumption:	184 W	106 W
Bottle capacity:	1,000 ml	1,000 ml
Flow (air litres/min):	18 l/min	40 l/min
Max suction:	-0.75 bar (563mm/Hg)	-0.80 bar (600mm/Hg)
Working time: minutes	20 ON / 40 OFF	120 ON / 60 OFF
Size (cm):	37x22xh 21 cm	37x22xh 21 cm
Weight:	3.5 kg	5.25 kg
Norms:	IEC 601-1	IEC 601-1

HIGH VACUUM, HIGH FLOW HOSPITAL SUCTION ASPIRATOR



Standard Clinic Plus and Hospi Plus



Clinic Plus and Hospi Plus with foot switch and electronic flow direction regulator

New innovative range of high vacuum, high flow aspirator ideal for hospitals. Pump piston type, lubrication and maintenance free. Supplied with hydrophobic 99% bacterial filter, vacuum gauge for control of vacuum and 2 autoclavable jars (2 or 4 litres) made in makrolon with 200/400 ml graduation and double security valve. Available on request 2 or 3 litre disposable liners. Range includes version with foot

TECHNICAL SPECIFICATIONS

	Hospi plus	Clinic plus
Operating voltage:	110 V or 230 V - 50/60 Hz	230 V - 50/60 Hz - 110 V on request
Maximum suction:	- 0.90 bar (675 mmHg)	- 0.90 bar (675 mmHg)
Operating cycle:	continuous	continuous
Flow:	90 l/min	60 l/min
Power:	300 VA	230 VA
Norms:	CEI 62-5 (IEC 601-1)	CEI 62-5 (IEC 601-1)
	93/42 EEC. Made in Italy	93/42 EEC. Made in Italy



Size: 460x850x420 mm
Weight: 20 kg

switch and flow direction regulator, 110 and 230 V. Four antistatic castors, two of which with brake, allow a perfect mobility. User manual in GB, FR, IT, ES, DE. See spare accessories at page 159, 166. Made in Italy.

code	CLINIC PLUS / HOSPI PLUS	Jar	Power	Foot switch	Flow direction diverter*
28194	CLINIC PLUS aspirator	2x2 l	220-230 V	-	-
28196	CLINIC PLUS aspirator	2x4 l	220-230 V	-	-
28198	CLINIC PLUS aspirator	2x4 l	220-230 V	yes	yes
28200	HOSPI PLUS aspirator	2x2 l	220-230 V	-	-
28199	HOSPI PLUS aspirator	2x2 l	110 V	-	-
28201	HOSPI PLUS aspirator	2x4 l	220-230 V	-	-
28203	HOSPI PLUS aspirator	2x2 l	220-230 V	yes	yes
28204	HOSPI PLUS aspirator	2x4 l	220-230 V	yes	yes

*Allow to direct suctioned liquids to any of the 2 jars

MAXI ASPEED HIGH FLOW ASPIRATOR FOR HOSPITAL USE



TECHNICAL SPECIFICATIONS

Operating voltage:	230 V - 50/60 Hz. Available on request 110 V - 60 Hz
Air flow:	60 or 90 l/min
Operating cycle:	continuous
Adjustable vacuum level:	0-0.90 bar (0-90 kPa)
Size:	470x580x560 mm
Weight:	15 kg (60 l), 17 kg (90 l)
MDD class:	Ila

MAXI ASPEED SURGICAL ASPIRATORS

Surgical aspirators for aspiration of body liquids in operating theatres and hospitals.

Easy to carry



Equipped with 4 antistatic wheels (2 with brake) and carrying telescopic handle.

Developed to run continuously

Made in highly heat resistant, electrically insulated plastic material in conformity with latest European safety standards. Vacuum regulator with BAR/PSI vacuumeter and automatic flow direction regulator to easily switch from a jar to the other. Supplied with 2 autoclavable polycarbonate jars with safety valve (overflow protection), set of atoxic sterilizable silicone tubes, 99% antibacterial hydrophobic filters (2) and multilanguage manual (GB, FR, IT, DE, ES). Made in Italy.

code	MAXI ASPEED	Jar	Power	Foot switch	Flow direction regulator
28285	Maxi Aspeed 60 l	2x2 l	230 V	-	yes
28286	Maxi Aspeed 60 l	2x2 l	230 V	yes	yes
28288	Maxi Aspeed 60 l	2x4 l	230 V	yes	yes
28289	Maxi Aspeed 90 l	2x2 l	230 V	-	yes
28291	Maxi Aspeed 90 l	2x4 l	230 V	-	yes
28292	Maxi Aspeed 90 l	2x4 l	230 V	yes	yes

ACCESSORIES

28294	Autoclavable jar 2 l with safety valve	
28295	Autoclavable jar 4 l with safety valve	
28297	Hydrophobic 99% antibacterial filter	
25482	Silicone tube - 8x14 mm - roll of 30m	

HIGH VACUUM, HIGH FLOW HOSPITAL SUCTION ASPIRATOR



28232



28231

Ideal for hospital, these suction aspirators are manufactured in ABS. Four antistatic castors, two of which with brakes, to allow perfect mobility. Vacuum gauge for the control of vacuum (1 bar). 2 or 4 litre jar made of autoclavable makrolon, with 200/400 ml graduation. Each jar with double security valve. Pump piston type, lubrication and maintenance free. With anti bacterial filter. Available model with footswitch and other operating voltage (110 V). User manual in GB, FR, IT, ES, DE. Made in Italy.

code	TOBI CLINIC / HOSPITAL	Jar	Power	Foot switch
28231	TOBI CLINIC - suction aspirator	2x2l	220-230 V	-
28214	TOBI CLINIC - suction aspirator	2x2l	220-230 V	yes
28215	TOBI CLINIC - suction aspirator	2x4l	220-230 V	-
28216	TOBI CLINIC - suction aspirator	2x4l	220-230 V	yes
28232	TOBI HOSPITAL - suction aspirator	2x2l	220-230 V	-
28202	TOBI HOSPITAL - suction aspirator	2x2l	220-230 V	yes
28233	TOBI HOSPITAL - suction aspirator	2x4l	220-230 V	-
28234	TOBI HOSPITAL - suction aspirator	2x4l	220-230 V	yes
28235	TOBI HOSPITAL - suction aspirator	2x2l	110 V	-

TECHNICAL SPECIFICATIONS

	Hospital (28202-28232/3/4/5)	Clinic (28214/5/6, 28231)
Size:	55x45xh 65 cm	46x42xh 60 cm
Weight:	20 kg	13 kg
Operating voltage:	110 V or 230 V - 50/60 Hz	110 V or 230 V - 50/60 Hz
Maximum suction:	- 0.90 bar (675 mm/Hg)	- 0.90 bar (675 mm/Hg)
Operating cycle:	continuous	continuous
Flow:	90 l/min	60 l/min
Norms:	CEI 62-5 (IEC 601-1) 93/42 EEC.	CEI 62-5 (IEC 601-1) 93/42 EEC.



28234

code	ACCESSORIES	
	FOR CLINIC/HOSPITAL, CLINIC PLUS, HOSPI PLUS	To be used with
28237	Hydrophobic, 99% bacterial filter	Hospital/ Hospi plus
28239	Hydrophobic, 99% bacterial filter	Clinic/Supervega Trolley
28236	121°C autoclavable jar 2l with overflow system	All 2 l aspirators
28227	Cover 2l with overflow valve system	28236
28228	121°C autoclavable jar 4l with overflow system	All 4 l aspirators
28223	Cover 4l with overflow valve system	28228
28186	134°C autoclavable jar 2l with overflow system	All 2 l aspirators
28184	Cover 2l with overflow valve system	28186
28187	134°C autoclavable jar 5l with overflow system	All 4 l aspirators
28272	Container for disposable liner 2l	All 2 l aspirators
28273	Disposable liner 2l cover+bag	28272
28274	Container for disposable liner 3l	Clinic/Hospital/ Hospital plus 2 l
28275	Disposable liner 3 l cover+bag	28274
25482	Silicone tube 8x14 - roll of 30 m	Clinic/Hospital
28253	Adapter to connect catheter to silicone tube	25482
	Suction catheter see at page 43	28253
28276	Vacuum indicator Ø 50 mm	Clinic
28277	Vacuum indicator Ø 60 mm	Clinic plus/Hospi Plus Hospital
28265	Bottom base	Clinic plus/Hospi Plus
28266	Bottom base	Clinic
28267	Bottom base	Hospital



GIMA LED COLPOSCOPE

• **29600 COLPY - GIMA LED COLPOSCOPE**
Easy to use LED colposcope mounted on a 5 wheels base (Ø 41 cm).

COLPOSCOPE TECHNICAL SPECIFICATIONS

Magnifying: 8.2X with standard 10X eyepieces
Field: 35 mm
Optic system: stereo with inter-pupil adjustment and optic head at 45°
Illumination: LED bulb
Working distance: 28 cm
Interpupillary distance: 48-77 mm
Green filter
Operating voltage: 100-240V, 50-60 Hz
Norms: CLASS I Type B - IEC 601-1 CE 93/42/EEC.
Made in Italy

• **29601 CAMERA CONNECTOR for 29602**

To connect a camera with standard "C mount" to GIMA colposcope.

• **29602 MC1 PAL CAMERA - for Colpy**
Fit the camera to one eyepiece and connect the video cable to a high definition monitor. Needs 29601.

• **29603 DL1 DIGITAL - USB 2.0 CAMERA with grabbing software for Colpy**
Fitted on one eyepiece, allows to show image on PC through USB connection, becoming a high definition videocolposcope.

TECHNICAL SPECIFICATIONS - 29602

Camera sensor: 1/3 CCD
Resolution: 480 lines
Power: 230 V - 50/60 Hz
RCA video composite output 3 m cable
Head size: 38x40x70 mm

TECHNICAL SPECIFICATIONS - 29603

CMOS 1/3" sensor
Max resolution pictures 1280x1024 pixels
Max resolution movie 440x480 pixels



Adjustable height observation 73-104 cm

29600

ALLTION LED COLPOSCOPE

• **29612 ALLTION LED COLPOSCOPE - 9X**

• **29613 ALLTION LED COLPOSCOPE**

3,75X, 7X, 15X - > 28,000 LUX

High quality and complete colposcopes, with excellent optics and cold, longlife white light.

Compact, lightweight and easy to use offers superior quality at a competitive price. A special universal Teflon® ball joint gives user 360° easy motion for gross focus. Comes assembled, ready for use.

TECHNICAL SPECIFICATIONS

Magnification 9X (29612) or 3,75X, 7X, 15X (29613)
Focus length: 316 (29612) or 300 mm (29613)
Field of view: diameter 22 mm or 30.93/15.50/7.64
Depth of field: > 4 mm (29612) or 18/4/2 mm (29613)
Light intensity: > 28,000 lux
Interchangeable adjustable eyepiece 12.5X
Illumination: longlife 5.9V / 5W LED
Superior optics with individually adjustable eyepiece
Built-in rheostat for brightness adjustment
Easily changeable, LED bulb
User-selectable built-in green filter
Two (gross/fine) focus adjustment handles
Two (gross/fine) height adjustment handles (838-1194 mm)
Smooth action control
Main Power: 110V/220V



Two circles for measuring size of tissues

Fine focus adjustment handle

CE

Gross height adjustment knob

360° motion

29613

Roller base for easy movement

DIGITAL LED VIDEO COLPOSCOPES

• **29620 COLPRO LED VIDEO COLPOSCOPE**

• **29622 COLPRO LED VIDEO COLPOSCOPE - FULL HD**

The digital video colposcopes COLPRO are the perfect combination of an advanced video technology and the feedback received from gynaecologists, users and stakeholders. They are known for their ruggedness and versatility and they provide high resolution images of cervix and genital area for effective colposcopy diagnosis and treatment.

Main features:

5 levels of light intensity to observe finest changes in tissue structure.
Electronic Green Filter: 4 different grades (5 for HD) ensure an optimal observation without any light loss.

5 image colours settings that guarantee best colour differentiation in epithelium.
Mirror and E-flip image: facility to change the direction of the image from left to right horizontally (mirror) or from upward to downward vertically (E-flip).

Gamma processor: assures high quality image processing for better visualization of vessels and tissue structure.

Magnification up to 55 times and Auto-focus: the colposcope focuses even if the patient moves. 1-55X (29620), 1-45X (29622).

Remote control allows to control the functions even from a distance.

Freedom of connectivity: can be connected to a TV or a monitor and to PC via USB. 2 video outputs can be taken on 2 different screens simultaneously.

User friendly design: ergonomic and user friendly design, easy to move. Height adjustable to have best positioning for colposcopy procedure.

Maintenance free, shadowless LED light source

• **72708 SONY LMD LCD MEDICAL MONITOR - 15" - support included**



29620

EMI/EMC tested

TECHNICAL SPECIFICATIONS

Image processor: Sony Japan colour CCD
Pixels: 1,200,000 (29620)
2,000,000 (29622)
Resolution: 825 TV Lines (29620)
1,000 TV Lines (29622)
E-flip: yes
Mirror image: yes
Electronic Shutter: automatic
S/N ratio: >48 db (29620), >50 db (29622)
Illumination: high MCD super bright white shadowless LED light
Colour temperature: 7,000° K
Test timer: yes
Multigrade green filter: yes (4 grades, 5 for HD)
Blue filter: yes
Focus: automatic and manual
Focus distance: 20-30 cm
Zoom: 1-55X (29620), 1-45X (29622)
Viewing area: Ø 170 mm - 10 mm
Depth of view: Ø 200 mm - 5 mm
Magnification display: Yes
Average LED lamp life: 50,000 hours
Video output: BNC and SVHS (both)
YPBPR and DVI (29622 only)
Safety standard: complies to IEC 60601 including EMC
Power supply: 100-240 VAC, 50/60 Hz
Made in Australia

COLPOSCOPY IMAGE, VIDEO & PATIENT DATA MANAGEMENT SOFTWARE

• **29621 COLPOSCOPY SOFTWARE FOR COLPRO COLPOSCOPE AND COLPY WITH DIGITAL CAMERA**

A powerful IT tool in the hands of our busy gynaecologists to manage not only videos, images, clinical data and details of the patients, but also to provide them an opportunity to store, edit, burn on CD or DVD, print the detailed reports and use graphical data for presentation. Multilanguage software (GB, ES, IT, DE, FR, PT). Footswitch for capturing and saving images. Compatible with Windows 7 (64-bit) / XP / Vista, Windows 8 and 10 Operating Systems. Easy to install and maintain. Password protected log-in to ensure data privacy. Enormous level of live recording facilities and image capturing at very high pixels simultaneously with just a click.

Various kinds of colposcopy video clippings, movies, images for reference and education purpose have been incorporated in the software. Print out of reports with relevant details can be prepared for future follow-up of the patient.

Comparison mode with linked images

Forensic examination & sexual abuse
Leep/Leitz approach to treat high grade dysplasia

Cryo surgery report

Statistical data representation with graph

Multiformat 1-2-3-4 images diagnosis report

HAMMOND graph (biopsy graph)

Marking and highlighting



SONOST 3000 - ULTRASOUND BONE DENSITOMETER

• **33996 SONOST 3000 with integrated software Waterless Ultrasound Bone Densitometer (BMD).** Sonost 3000 is a portable, economic solution for evaluating the risk of osteoporotic fracture. Its high accuracy assists in the first diagnosis of osteoporosis monitoring bone changes. It provides fast, convenient and easy-to-use informations on bone quality and fracture risk. It can be connected to a keyboard to a monitor for data reading and to an external printer for A4 printing

- Main features:
- superior precision
 - full dry and stand alone system
 - fast measurement (only 15 seconds)
 - auto positioning probe
 - permanent coupling pad
 - over 10,000 memories
- Manual: GB, IT (ES on request).

• **33250 THERMAL PAPER 57 mm x 25 m (pack of 5 rolls)**



Software is integrated in Sonost 3000 that can be connected to a monitor or typewriter

TECHNICAL SPECIFICATIONS

Measurement site:	Calcaneus (Heel bone)		
Scan Time:	15 seconds		
Measurement:	Estimated heel BMD and Bone Quality Index (BQI) Obtained from measured Broad band Ultrasound Attenuation (BUA) and Speed of Sound (SOS)		
Estimated Index:	SOS (C.V.%)	BUA (C.V.%)	BQI (C.V.%)
In Vivo:	0.2	1.5	1.5
Transducer:	25 mm - 100 mm		
Separation range:	Automatic adjustment		
Storage capacity:	10,000 patient information		
Coupling method:	coupling gel (water not used)		
Display:	6.4 inch TFT LCD (65536 colour)		
User Interface:	Touch screen USB for connection to mouse or keyboard		
Printer:	Thermal Printer		
Operating voltage:	AC 100V-240V - 50/60Hz - 130W		
Dimension:	30x62x39 cm		
Weight:	12 kg		

AC-2311 LED VIDEO COLPOSCOPE WITH CAMERA

• **29624 AC-2311 LED VIDEO COLPOSCOPE WITH CAMERA**

- **Superb optical features:**

The excellent optical design allows:

- 1 - high resolution
- 2 - real 3-dimensional precise image reproduction
- 3 - large depth of field
- 4 - wide field of view
- 5 - good contrast

Apochromatic optics design can correct the chromatic aberration of three types of coloured light effectively. It ensures the reduction and saturation of image colour and improves resolution, contrast and view depth of image.

- **3-step magnification:**

3-step magnification (3.75X - 7.5X - 15X) provides larger magnifying range and more selection from lowest magnification for an overview to high magnification for precise and close inspection and treatment.

- **Two optical circles for quick measuring size or tissue**

- **Integrated green filter**

It can help to recognize blood vessels

- **LED illumination**

LED coaxial illuminator provides pure white colour light similar to sunlight to show real colour. Bulb life over 10,000 hours/10 years for long lasting performance. It saves your cost for the spare bulbs & electric charge.

- **Integrated camera**

The images from integrated video camera can be transferred directly into a monitor or a TV, into a computer with USB adapter or stored into a hard disk recorder.

- **Ergonomic design for comfortably long time precision operation**

It is supplied completely assembled and ready for use

• **29621 COLPOSCOPY SOFTWARE** - see page 167



TECHNICAL SPECIFICATIONS

Total magnification	3.75X, 7.5X, 15X	adjustment
300mm focal length		User-selectable built-in green filter for enhanced contrast
Field of View: Ø 79 mm, 39 mm, 19 mm		LED bulb is easily changeable
Depth of Field: 4.5 mm, 1.13 mm, 0.76 mm		Working height: 975 mm to 1,135 mm
Light intensity >25,000 LUX		Fine focus adjustment handles
Individually adjustable eyepiece 16.7X		Two (Gross/Fine) height adjustment handles
Right eyepiece with built-in two circles to measure the size of the problem you see		Main power supply: 100 V to 240 V
Built-in rheostat for brightness		Weight: 11 kg

PC-8000 PRO HOSPITAL FOETAL MONITOR

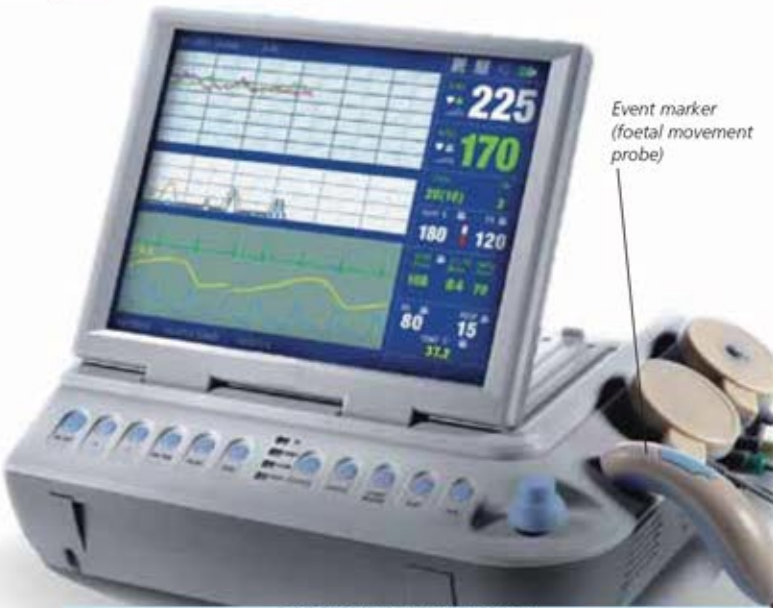

- 29550 PC-8000 PRO SINGLE FOETAL MONITOR
 - 29551 PC-8000 PRO TWINS FOETAL MONITOR
- Maternal foetal monitor suitable for hospital use.

- Main features:
- 12.1" High-brightness TFT display (800x600 pixel)
 - parameters: ECG, SpO₂, NIBP, TEMP, RESP, PR, FHR, TOCO & FM
 - rotatable screen viewed from different directions and 5 different styles of operation display
 - equipped with reliable, high sensitivity, 12-element pulse doppler transducer
 - FHR and TOCO trend review
 - store and view of 48-hours monitoring data
 - built-in Linux operation system
 - built-in high-speed thermal printer
 - internal rechargeable Li-ion battery
 - visual and audible alarms
 - selectable internal software: GB, FR, IT, ES, PT, PL, RU, TR.

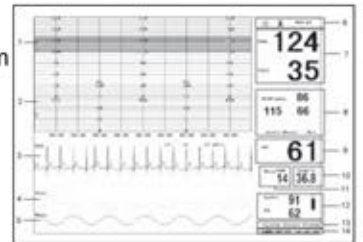

STANDARD ACCESSORIES			
US probe (ultrasonic probe)	1 (29550 only)	Blood pressure cuff	1
US probe (ultrasonic probe)	2 (29551 only)	Blood oxygen probe	1
UC/TOCO probe (uterine contraction probe)	1	Body temperature probe	1
Event marker (foetal movement probe)	1	Power cable	1
Abdominal belt	2	Grounding wire	1
Ultrasonic coupling gel	1	Disposable electrode	10
ECG cable	1	User Manual (GB, IT)	1

code	PC 8000 PRO ACCESSORIES		
29552	US probe (ultrasonic probe) - spare		
29553	UC/TOCO probe - spare		
29554	Event marker (foetal movement probe) - spare		
29555	Abdominal belt - spare		
29556	Z-fold paper 112x100 mm for 29550 - 20 boxes of 150 sheets		
29557	Z-fold paper 150x100 mm for 29551 - 25 boxes of 150 sheets		
33297	3M RED DOT™ electrodes Ø 6 cm - box of 1,000		

TECHNICAL SPECIFICATIONS

Foetal monitoring:

Ultrasonic probe

Ultrasonic working frequency: 1 MHz tolerance: ±5%
ISATA: ≤10 mW/cm²

Foetal heart rate measuring range: 50 - 240 bpm ±2 bpm

FHR alarm: when the FHR value exceeds the preset value, the monitor will send an alarm for 30 s that will stop by pressing alarm key

TOCO probe

Zero setting mode: manual

TOCO measuring range: 0 - 100% tolerance: ±10%

Marker mode

Mode: Manual and AUTO

ECG/RESP Monitoring:

ECG amplification bandwidth:

Monitoring mode: 1 - 40 Hz (+0.4 db -3 db)

Diagnostic mode: 1 - 75 Hz (+0.4 db -3 db)

HR range: 30 - 300 bpm (±1% or ±1 bpm, whichever is greater)

CMRR (Common-Mode Rejection Ratio): ≥80 dB

Time constant: Monitoring mode: ≥0.3 s, Diagnostic mode: ≥3.2 s

ECG gain: X1/2 5 mm/mV ±5%, X1 10 mm/mV ±5%, X2 20 mm/mV ±5%

RESP monitoring range: 0-100 rpm (±5% or ±2 rpm, whichever is greater)

NIBP Monitoring:

Measuring technology: Automatic measurement by smart oscillating method

Initial cuff inflation pressure: adult mode 180 mmHg

Max. inflation pressure allowed: adult: 300 mmHg

Accuracy: ±10% or ±10 mmHg, whichever is greater

Factory-set measuring mode: manual

Measuring intervals: 1-240 minutes adjustable, interval tolerance: <10s

Monitoring range: Systolic pressure: 50 - 240 mmHg

Mean arterial pressure: 25 - 200 mmHg

Diastolic pressure: 15 - 180 mmHg

Measurement accuracy ±8 mmHg

SpO₂/Temperature Monitoring:

Pulse oxygen saturation range: 0 - 99% (75 - 99% ±2%, 50 - 74% ±3%)

Pulse rate: 30 - 240 bpm (±2% or ±2 bpm, whichever is greater)

Temperature response time: ≤150 s

Other Technical Information and Parameters:

Mains power supply: 100 - 250 VAC, 50/60 Hz <100 VA

Internal power supply: Li-ion, rechargeable battery

6 hours to full recharge during monitoring

4 hours to full recharge when monitor is off

Display mode: TFT display

Alarm: audible & visible alarm

Networking interface: Net port

Printing paper Z-Fold, 112x90 mm

Protection against electric shock: Class I

Size: 36x30x12 cm

Weight: 4 kg

Built-in thermal printer

1/2/3 cm/min real time printing speed, fast print speed (stored traces)

Record message ID, name, age, date, time, print speed etc.

GIMA FOETAL MONITOR PAPER FOR DIFFERENT BRANDS

code	FOETAL MONITOR manufacturer and model	Standard FHR rate/BPM**	Type	Width mm	Length mm or m'	Sheet	Grid***	Min. order
BIONET								
29528	Fetalcare FC/1400	Int 60/200	roll	152	25	-	green	10
29522	Fetalcare FC/700	US 60/240	roll	215	23	-	green	5
29544	Fetatrack 310	US 60/240	pack	114	100	150	blue	20
COMEN								
29556	Star 5000/C	Int 60/210	pack	112	100	150	or/red	20
29558	Star 5000/D	Int 60/210	pack	151	100	150	or/red	25
29557	Star 5000/D	US 30/240	pack	151	100	150	or/red	25
COROMETRICS								
29561	4305-BAO mod. 116-145-150-151-118	Int 60/200	pack	152	90	150	or/red	25
29562	4305-BAO mod. 116-145-150-151-118	US 30/240	pack	152	90	150	or/red	25

*mm (pack) or m (roll)

**International or US standard FHR rate/BPM

code	FOETAL MONITOR manufacturer and model	Standard FHR rate/BPM**	Type	Width mm	Length mm or m'	Sheet	Grid***	Min. order
EDAN								
29569	Cadence II	US 30/240	roll	112	90	150	or/red	20
29570	F/6-F/9	Int 60/200	pack	152	90	150	or/red	25
29571	Cadence II	Int 60/200	roll	112	90	150	or/red	20
HEWLETT PACKARD								
29575	9270-0630 - 8040/A, 8030/A, 8020/A	Int 60/200	pack	151	100	150	green	25
29576	M1911A	Int 60/200	pack	151	100	150	green	25
SHENZHEN CREATIVE								
29556	PC-8000 PRO single	Int 60/210	pack	112	100	150	or/red	20
29558	PC-8000 PRO twins	Int 60/210	pack	151	100	150	or/red	25
29557	PC-8000 PRO twins	US 30/240	pack	151	100	150	or/red	25
SONICAID								
29580	Meridian/800 - Team	White paper	pack	143	150	300	white	10

***or/red: grid could be orange or red colour

TWIN FOETAL MONITOR - 7" TOUCH SCREEN COLOUR TFT LCD

- 29516 NEW FC1400 SINGLE FOETAL MONITOR
- 29517 NEW FC1400 TWIN FOETAL MONITOR

Antepartum foetal monitor to measure Foetal Heart Rate (FHR), degree of material uterine contraction (UA: Uterine Activity), foetal movements (FM)

Superior data display

- 7" full touch screen colour TFT LCD (800x480)
- 2 display modes: graphic and text modes
- 72 hours of memory capacity

Extreme data accuracy and access

- high-accuracy and wide detection area
- easy on-screen scrolling function
- durable watertight probes,



Event marker
1 MHz probe
Toco probe
USB function memory storage Wi-Fi convert
Yellow/green LED alarm for easier recognition of device and patient status



2 display modes

10 smart keys for 16 functions



Compact probes and robust connector

1 MHz to minimize broken FHR waveforms even if the fetus moves

Trolley suitable for 29520 and 29516-7

Printout

- CTG interpretation report
- both standard and A4 size paper usable
- normal fax paper usable

Other advantages

- Wi-Fi central monitoring up to 16 beds (Option)
- PC compatible
- internal battery lasting 2-hours (Option)
- power adapter 100-240 V, 50-60 Hz
- multilanguage internal software: GB, FR, IT, ES, PT, DE, PL, RO, RU, CZ, HU, BG, TR, KR, CN.
- Recommended after week 30



Adjustable height

Revolving castors

29519

TECHNICAL SPECIFICATIONS

Dimensions	296x97.5xh 305.5 mm - Approx. 2.9kg
Display	7" TFT Wide LCD screen (800x480)
Thermal array printer:	print speed: 1, 2, 3 cm/min (real time) paper feeding function
Power	input: 100-240 V, 1.5-0.7 A, 50-60 Hz output: +18 V = 2.8 A
Li-ion battery (option)	4 hours (charging) - 2 hours (discharging)
External link	LAN, Wi-Fi, USB memory
Foetal heart rate	input signal: ultrasound pulsed doppler ultrasound frequency: 1.0 Mhz, 975 KHz ultrasound power: <10 mW/cm ² FHR detection method: autocorrelation FHR range: 50-210 bpm ±1 bpm (120-160)
Foetal movement measurement	detection source: ultrasound pulsed doppler, event marker
Uterine contraction	input source: external transducer with load cell reference control: one touch switch, auto zeroing measurement range: 0-99
Auto CTG analysis	average baseline FHR number of UC number of acceleration number of deceleration late deceleration early deceleration
	variable deceleration high episode low episode short term variability signal loss

COST-EFFECTIVE SINGLE FOETAL MONITOR

- 29520 FOETAL MONITOR GIMA FC 700
- Cost-effective single foetal monitor

Extreme ultrasound doppler sensitivity

- high-accuracy with 1 Mhz frequency
- automatic/manual Foetal Movement detection
- auto NST (Non-stress test) function from 10 min. to 1 hour.

Data printout

- CTG analysis printing
- A4 size chart paper with perforation line
- plain thermal fax paper usable
- print speed 1, 2, 3 cm/min

Easy-to-use

- one-touch operation and easy setup
- alarm function (FHR high-low)
- s/w upgrade via internet

TECHNICAL SPECIFICATIONS

Dimensions	296x92.5xh 305.5 - approx. 2.9 kg
Display	7 segment LED - 2 channels (FHR, UC)
Thermal printer	print speed: 1, 2, 3 cm/min paper feeding function
Power adaptor	input: 100-240 VAC, 50-60 Hz, 1.2 A output: 18 VDC, 2.5 A
External link	RS-232C
Foetal heart rate	input signal: ultrasound pulsed doppler ultrasound frequency: 1.0 Mhz ultrasound power: <10 mW/cm ² FHR detection method: auto correlation FHR range: 50-240 bpm ±1 bpm (120-160)
Uterine contraction	reference (zero) control: one touch switch measurement range: 0-99 units
Foetal movement measurement	detection source: ultrasound pulsed doppler
Auto CTG analysis	average baseline FHR number of UC number of acceleration number of deceleration (late, early, variable) Tachycardia (moderate, severe) Bradycardia (moderate, severe)

ACCESSORIES FOR FC700 AND FC1400 FOETAL MONITORS

For 29520	For 29530-31	For 29516-17	ACCESSORIES FOR FOETAL MONITORS
29522	-	-	Paper roll - 215 mm x 23 m
-	29528	29528	Paper roll - 152 mm x 25 m
29523	29532	29538	US doppler probe - spare
29524	-	-	UC/Toco probe up to S/N FF07XXX
29529	-	-	UC/Toco probe since S/N FF08XXX
-	29533	29539	Toco transducer - spare
29519	29519	29519	Trolley with 2 baskets (adjustable height)
-	29534	-	Battery NI-MH, 12 V, 2,600 mA
-	-	29536	Li-Ion battery
33747	33747	33747	AC adaptor
29525	29525	29525	Belt 5.3x148 cm

• 29527 WIRELESS CENTRAL STATION FOR FOETAL MONITORS

Central station (PC, monitor, software, wireless, connection kit) to manage up to 16 monitors.



Wireless bluetooth 16 beds central system (distance 10-100 m)

STANDARD ACCESSORIES (29516, 29517, 29520, 29530, 29531)		
1 US doppler probe (2 for 29517 and 29531)	1 ultrasonic gel	1 power cord
2 (29520) or 3 fixing belt (29516-7)	1 stand	1 user manual
1 TOCO probe	2 paper rolls	
1 marker for lying-in women	1 adaptor	

GIMA FOETAL POCKET DOPPLERS - MADE IN U.K.



• **29503 GIMA FOETAL DOPPLER D2003 with display**
Pocket foetal doppler with same specification as code 29502 but with built-in foetal heart rate processing. Foetal heart rate (FHR) is displayed on a large LCD display whilst internal signal process minimises noise artefacts.

• **29505 GIMA FOETAL DOPPLER D2005 with display and waterproof probe**

Same as code 29503 but waterproof probe and sealed electronics. All units are supplied in a nice bag with a tube of coupling gel and user manual in English, Spanish, French, German, Italian, Greek, Portuguese.



• **29512 ON/OFF MEMBRANE SWITCH** for codes 29503, 29505

29503

• **29502 GIMA FOETAL DOPPLER G2002**

Small, lightweight, high sensitivity pocket Doppler, with 2 MHz foetal probe, ideal for General Practitioner's or Midwife's use for routine antenatal foetal detection.

Pocket Doppler can be used to detect the beating foetal heart from about 10th week of gestation. It may be used to locate the position of the placenta, thus aiding in the early diagnosis of placenta praevia, to survey blood flow of the umbilical cord and to diagnose multiple pregnancies. Foetal signals are easily located using the lightweight narrow beam transducer while internal signal processing minimizes noise artefacts. Audio foetal heart signals are available to the user via the built-in loudspeaker or option headset, with output level controlled by rotary volume control.

• **29511 ON/OFF MEMBRANE SWITCH** for code 29502

TECHNICAL SPECIFICATION (CODES 29502 - 29503 - 29505)

Ultrasound	Frequency: 2 MHz continuous wave Transducer: 2 crystal narrow beam Output power: <10mW/mm ² SATA Audio Response 300Hz - 1 KHz autocorrelator (only code 29503 and 29505)
FHR (Fetal heart rate):	50-210 bpm (29503, 29505) 60-210 bpm (29502) resolution ± 1 bpm, accuracy ± 2 bpm
Unit Controls	Keys: 1 Key (for unit on/off) Controls: rotary volume
Indicators:	3 digit FHR LCD display (codes 29503, 29505) FHR pulse icon (codes 29503, 29505), Battery low icon
Power supply	Battery 9 V Alkaline Manganese Expected battery life: 8 hours
Output	Headset: Audio output to optional headset Serial: RS232 interface (codes 29503, 29505)-jack 35 mm

Material: ABS / Noryl
Size: 150 mm by 75 mm Weight: 295 g (with transducer)
Classification: Class I Type B - IEC 60601-1 CE 0120
Warranty: 2 years (probe and cable included) Made in UK

SONOTRAX DOPPLERS



SUPPORT
2MHz, 3MHz, 4MHz, 8 MHz
WATERPROOF PROBES

29493

TECHNICAL SPECIFICATIONS

Size: 32x85x138 mm
Weight: 290 g (including battery)
Heart rate range: 50-210 bpm
Resolution: 1 bpm
Accuracy: ± 3 bpm
LCD display: 45x25 mm (only code 29491-93)
Auto average and manual mode
Recording length: 480 s / 240 s
Auto power-off to save power
Manual: GB, IT - on request: DE, ES, FR, PT.

BABY SOUND GIMA DOPPLER



• **29506 BABY SOUND GIMA FOETAL DOPPLER with display and interchangeable 1MHz probe**
- portable and lightweight
- built-in speaker to hear fetal heartbeats
- numeric and trend curve display for FHR
- automatic power-off function
- backlight LCD display
- date, time, battery status display
- audible & visual FHR alarm
- 8-hour data storage
- audio-out interface
- fetal monitor DSP technology
- high-sensitivity probe
- 1 MHz or 2/2.5 working frequency
- store and recall FHR, up to 16 hours of FHR date storage
- recording function

It allows hearing regularly the heartbeat of a foetus since 20 weeks, and warns in case of serious problems of the fetus (can monitor FHR during 10-12 weeks not regularly). For home and hospital use. Supplied with gel bottle, 3 AA batteries and user manual.

• **29507 2.0/2.5 MHz DOPPLER PROBE**

• **29508 1 MHz FOETAL MONITOR PROBE**

The Fetal Doppler can be used as a portable Fetal Monitor if it works with 1MHz Fetal Monitor probe. It is suitable for long-term monitoring and will be more accurate than with the Doppler probe.

TECHNICAL SPECIFICATION

Ultrasound working frequency:	1MHz ± 5%
Fetal heart rate:	range: 50-210 bpm resolution: 1 bpm accuracy: ± 2 bpm
Alarm:	high limit: 160 bpm low limit: 120 bpm
Ultrasound intensity:	< 5 mm/cm ²
Dimension:	145x74x29 mm
Power supply:	3 AA Batteries
Weight:	350 g



code	DOPPLERS AND INTERCHANGEABLE PROBES - LATEX FREE
29490	SONOTRAX LITE DOPPLER - without probe - with bag
29491	SONOTRAX BASIC DOPPLER - with display - without probe - with carrying bag
29493	SONOTRAX PRO II DOPPLER with backlighted display built-in audio recorder and rechargeable batteries with battery charger - without probe - with carrying bag
29496	2MHz waterproof probe - gynaecology
29497	3MHz waterproof probe - gynaecology
29498	4MHz waterproof probe - vascular
29499	8MHz waterproof probe - vascular



SONOLINE "C" COLOUR SCREEN DOPPLER - FOETAL OR VASCULAR

COLOUR SCREEN POCKET DOPPLER

- portable and lightweight
 - built-in speaker
 - TFT-LCD, real-time display of FHR
 - three working modes: real-time FHR, average FHR and manual calculation
 - display of FHR, bar graph and heartbeat waveform, red alarm for abnormal FHR
 - low power consumption, continuously work for more than 8 hours with two "AA" batteries
 - indication for probe-off and low battery
 - range of probes for foetal or vascular use: 2, 3, 4, 8 MHz probe
- Suitable for use after the 12th week of pregnancy



TECHNICAL SPECIFICATIONS	
Ultrasound working frequency:	2 MHz ± 10%
Fetal heart rate:	range: 50-240 bpm resolution: 1 bpm accuracy: ± 2 bpm
Alarm:	high limit: 160 bpm low limit: 120 bpm
Ultrasound intensity:	< 5 mm/cm ²
Auto power off after 1 minute no signal	
Dimension:	135x92x29 mm
Weight:	245 g
Power supply:	2 AA Batteries LR6 - 1.5 V DC

code	SONOLINE "C" COLOUR SCREEN DOPPLER
29480	SONOLINE "C" Colour screen doppler - without probe
29481	2 MHz waterproof probe - gynaecology
29482	3 MHz waterproof probe - gynaecology
29483	4 MHz waterproof probe - vascular
29484	8 MHz waterproof probe - vascular

LATEX PROBE COVERS



- 29510 LATEX PROBE COVERS - transparent - bag of 100 pcs - bulk
 - 29513 LATEX PROBE COVERS - transparent - box of 50
 - 29514 LATEX PROBE COVERS - transparent - box of 500
- Probes for ecography and doppler. Length 17 cm, Ø 3.3 cm
Individually packed in single plastic bag, except 29510.

AMNIOCENTESIS NEEDLES

For transabdominal sampling of amniotic fluid (usually between 15th and 18th pregnancy week) for prenatal diagnosis of genetic disorders of the foetus. It is also used for cytogenetic and biochemical studies. Accurate sharpening of the needle allows an easy and atraumatic insertion. Its mandrel is provided with an ultrasound detectable tip allowing an echo-guided insertion, and it is colour coded for an easy identification of the needle size. The needle is provided with an adjustable stopper to determine insertion depth, and with a female luer lock connector to collect the amniotic fluid through a syringe. Made in Italy.

code	AMNIOCENTESIS NEEDLES - STERILE - box of 25
29636	Needle 20 G x 100 mm
29637	Needle 20 G x 120 mm
29638	Needle 20 G x 150 mm
29639	Needle 20 G x 180 mm
29640	Needle 21 G x 120 mm
29641	Needle 21 G x 150 mm

OBSTETRIC STETHOSCOPIES

- 32501 SHORT OBSTETRIC STETHOSCOPE - beech-wood
 - 32502 LONG OBSTETRIC STETHOSCOPE - beech-wood
- These stethoscopes are hand-craft manufactured, made in beech-wood accurately selected and seasoned for at least 3 years. They have a perfect finish with a special transparent varnish. Packed in single box. Made in Germany.
- 32505 PINARD STETHOSCOPE - aluminium



SUCTION CUPS

- 29980 SILICONE SUCTION CUP - Ø 60x210 mm
- 29981 SILICONE SUCTION CUP - Ø 70x210 mm

Made in medical grade silicone.
Compatible with Gima aspirators, preferably over 20 l/min.
Pressure to be adjusted by professional.

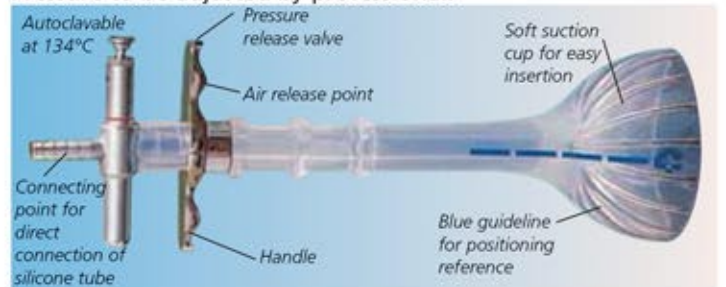

Instrument can also be read in the dark thanks to the luminescent substance used on the scale

SCHULTZE SALPINGOGRAPH

- 29780 SALPINGOGRAPH
- Instrument for hystero-salpingography and tubal insufflation, Prof. Gunter K. F. Schultze from Berlin type. Made in Germany.

- 29782 WATCH FOR SALPINGOGRAPH
- 29785 HYSTERO SYRINGE - 20 cc - LUER LOCK - spare

HYSTEOSALPINGOGRAPH: STANDARD ACCESSORIES

- Watch for hystero
- Hystero syringe 20 cc Luer Lock
- Rack-bar
- 3 interchangeable cones (small-medium-large)



DELIVERY SETS



- **38953 DELIVERY PACK - sterile - 7 pcs**
 Umbilical scissors - 10.5 cm - US model 2x Spencer Wells artery forceps - straight - 13 cm
 Mayo gynaecological scissors - straight - 17 cm 2x Umbilical cord clamps. Super crepe sheet



- **26966 MINOR DELIVERY SET - 25 pcs**
 Kidney Dish 20 cm (8") - medium Dissecting forceps toothed 1x2 - 14 cm
 Kidney Dish 25 cm (10") - large 2 operating scissors sharp/blunt - straight - 15 cm
 Gallipot 150 ml - 6 oz - medium 2 operating scissors sharp/blunt - curved - 15 cm
 Brown Sadler episiotomy scissors - 14 cm 2 rampley sponge holding forceps - str. - 24 cm
 Kocher artery forceps straight - 16 cm Museux Vulsellum forceps 8 mm - str. 24 cm
 Kocher artery forceps straight - 18 cm 3 Cusco vaginal specula - small, medium, large
 Kocher artery forceps curved - 16 cm 3 Sims vaginal specula - small, medium, large
 English TOE dissecting forceps plain - 14 cm Umbilical scissors USA Patent - 10.5 cm
 English TOE dissecting forceps plain - 18 cm Instrument tray with lid 45x30x6.2 cm

GYNAECOLOGY SET - STERILE



- Non woven bi-layer fabric gynaecology set
- **23641 GYNAECOLOGY SET - sterile - box of 8**
 1 table cover 150x200 cm with central absorbent band collection with filter and drain valve
 1 Mayo stand cover 80x145 cm 1 drape 75x90 cm
 1 gynaecology drape for lithotomy position 290x240 cm with adhesive hole, built-in leggings, bag for liquid 1 incision film 35x50 cm
 3 adhesive strips 10x50 cm
 4 towels 35x40 cm
 - **23644 SET FOR CESAREAN SECTION - sterile - box of 8**
 1 table cover 150x200 cm with central absorbent band 260x200x310 cm with incision film and bag for liquid collection
 1 Mayo stand cover 80x145 cm 1 drape "baby blanket" 75x90 cm
 1 drape for caesarean section See picture at page 28

CUPS FOR HYSTEROGRAPHY AND SIFT SCREW SYRINGE



- **29920 CUPS FOR HYSTEROGRAPHY - 25 mm - sterile**
- **29921 CUPS FOR HYSTEROGRAPHY - 30 mm - sterile**
- **29922 CUPS FOR HYSTEROGRAPHY - 35 mm - sterile**
- **29923 CUPS CONNECTOR - sterile**

S/S UMBILICAL SCISSORS



- **38835 UMBILICAL SCISSORS** • **26827 S/S UMBILICAL SCISSORS**
 Straight - 10.5 cm - US model - box of 25 Straight - 10.5 cm - US model

UMBILICAL CLAMP



- **29942 X-SAFE UMBILICAL CORD CLAMP - sterile - box of 500**
 Disposable umbilical cord clamp to allow a proper clamping of all umbilical cords and prevent their outcoming from the closing comb. Individually packed in coupled cellophane (nylon/polyethylene) and medical paper to ensure safe hygienic conditions to user. Sterilized by ethylene oxide. Made in Europe.

MEMBRANE PERFORATOR



- **29945 AMNIOTIC MEMBRANE PERFORATOR - sterile - box of 600**
 Disposable amniotic perforator. This system is thought to be completely safe to avoid lesions to the foetus. Supplied in single sterile envelope.

I.D. BRACELET



GIMA code	I.D. BRACELET	Colour	Minimum order
29936	Newborn	light blue	box of 100 pcs.
29937	Newborn	pink	box of 100 pcs.
29938	Mother	light blue	box of 100 pcs.
29939	Mother	pink	box of 100 pcs.

DISPOSABLE ANO/PROCTO/SIGMOIDOSCOPES

- **25953 F.O. ILLUMINATION HEAD**
Perfectly fits and illuminates GIMA, HEINE, WELCH ALLYN, GPS disposable anoscopes, rectoscopes, proctoscopes. It can be connected to a light source by a F.O. cable or to a LED illumination system. See at page 195.
- **25947 DISPOSABLE ANOSCOPE - sterile - box of 60**
Length 10 cm, with stylet diameter 15 mm, suitable for treatment of haemorrhoids. Atoxic, phthalate and latex free.
- **25949 DISPOSABLE RECTOSCOPE - sterile - box of 50**
Length 25 cm, with stylet diameter 15 mm, graduated external scale in cm. Internal black tube allows accurate lighting. Atoxic, phthalate and latex free.
- Disposable proctoscope see at page 152.
- HEINE UNISPEC DISPOSABLE TUBES**
- **25944 HEINE UNISPEC DISPOSABLE ANOSCOPE 85x20 mm**
E-003.19.911 - box of 25
- **25945 HEINE UNISPEC DISPOSABLE PROCTOSCOPE 130x20 mm**
E-003.19.811 - box of 25
- **25946 HEINE UNISPEC DISPOSABLE SIGMOIDOSCOPE 250x20 mm**
E-003.18.811 box of 25



ILLUMINATION OF F.O. ANO/PROCTO/SIGMOIDOSCOPES



- **30799 ILLUMINATED HANDLE 6.0 VOLT**
Placed between the instrument and F.O. cable. Independent light source for F.O. instruments. Direct connection to all F.O. instruments.
- **30800 HALOGEN BULB - spare for 30799**
- **30801 GIMA LIGHT SOURCE - see page 195**
To connect anoscopes/rectoscopes/sigmoidoscope to Gima light source (30801) you need: F.O. cable (30818-30826), adaptor (30830) to connect cable to light source, 2 adaptors (30840, 30844) to connect sigmoidoscope to F.O. cable.

F.O. ANOSCOPES, PROCTOSCOPES



code	F.O. ANOSCOPES - PROCTOSCOPES	ADAPTOR included
29400	F.O. Anoscope Ø15x70 mm - with obturator	Wolf/Acmi/Storz
29401	F.O. Anoscope Ø20x70 mm - with obturator	Wolf/Acmi/Storz
29402	F.O. Anoscope Ø25x70 mm - with obturator	Wolf/Acmi/Storz
29403	Set of 3 F.O. anoscopes in a case	Wolf/Acmi/Storz
29405	F.O. Proctoscope Ø 20x130 mm - with obturator with 2.0X	Wolf/Acmi/Storz
30840	ENDO STORZ ADAPTOR - to connect with Gima F.O. cable	



F.O. SIGMOIDOSCOPES



code	F.O. SIGMOIDOSCOPES WITH 1.5X MAGNIFICATION SWIVEL LENS	ADAPTOR included
29410	F.O. Sigmoidoscope - 12x200 mm	Wolf/Acmi/Storz
29411	F.O. Sigmoidoscope - 16x250 mm	Wolf/Acmi/Storz
29412	F.O. Sigmoidoscope - 21x200 mm	Wolf/Acmi/Storz
29413	F.O. Sigmoidoscope - 21x250 mm	Wolf/Acmi/Storz
29414	F.O. Sigmoidoscope - 21x300 mm	Wolf/Acmi/Storz
30840	ENDO STORZ ADAPTOR - to connect with Gima F.O. cable	

code	S/S ACCESSORIES FOR F.O. ANOSCOPES, PROCTOSCOPES, SIGMOIDOSCOPES
29420	Handle for Biopsy forceps
29421	Biopsy forceps 3.5x8 mm Cup Jaws - 420 mm
29422	Biopsy forceps 4 mm - Cutting Jaws - 420 mm
29425	Sponge Holding forceps - 400 mm
29426	Suction Tube - 400 mm
29427	Twin Bellow Insufflator

AMNIOSCOPE: TUBES AND SET

- **29970 AMNIOSCOPE SET** includes 29971/2/3/5 and 30840
Set of three amnioscope tubes with shutter 200 mm length, 12, 16 and 20 mm diameter, and a clamp for fibre optic light. All tubes are graduated in centimetres, have a rounded end and are sterilizable by any method. Supplied in a cordura bag (27129). To light amnioscope set you can use GIMA 150 light source (code 30801), adaptor (code 30830), F.O. cable (code 30818).
- **29971 AMNIOSCOPE TUBE 12x24x200 mm**
- **29972 AMNIOSCOPE TUBE 16x24x200 mm**
- **29973 AMNIOSCOPE TUBE 20x24x200 mm**
- **29975 ANGLED CLAMP FOR LIGHT CONNECTION**



DISPOSABLE STERILE VAGINAL SPECULUM



SIDE SCREW SPECULUM - with gradual adjustment - sterile
 Disposable sterile speculum with gradual screw-action adjustment. Available in 3 sizes.
 Made in China.

code	SIDE SCREW VAGINAL SPECULUM - STERILE	Minimum order
29983	SIDE SCREW speculum - small Ø 20 mm	box of 100
29984	SIDE SCREW speculum - medium Ø 28 mm	box of 100
29985	SIDE SCREW speculum - large Ø 33 mm	box of 100
29986	SIDE SCREW speculum - mixed* sizes	box of 100

*mixed box includes 20 small, 70 medium, 10 large vaginal speculum



CENTRAL PIN, MIDDLE SCREW, TACHE SPECULUM

Three different models of disposable sterile speculum.
 Sold in mixed box containing 3 sizes: small, medium, large.
 Made in China.

code	CENTRAL PIN / MIDDLE SCREW / TACHE STERILE	Minimum order
29991	CENTRAL PIN Speculum - mixed* sizes	box of 100
29995	MIDDLE SCREW Speculum - mixed* sizes	box of 100
29987	TACHE Speculum - mixed* sizes	box of 100

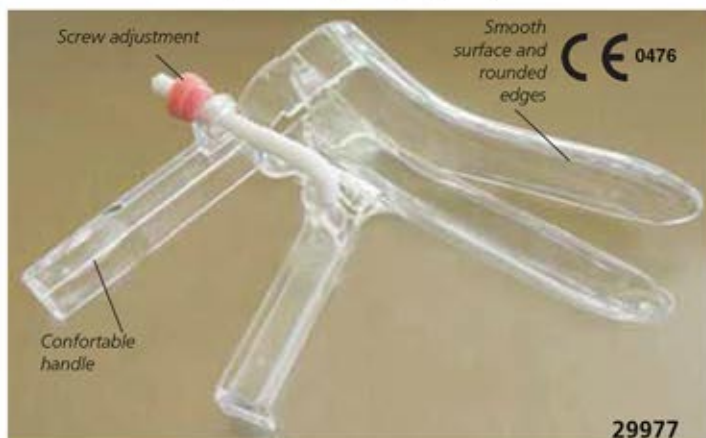

CUSCO SPECULUM - with gradual adjustment - sterile
 Disposable speculum with gradual screw-action adjustment. It is manufactured with the best non-toxic transparent material, comes in a single transparent vacuum pack and is sterilized with ethylene oxide. Sterilization is guaranteed by the special quality control label on each pack. Available 3 sizes distinguishable through screw colour. Made in Europe.

code	CUSCO VAGINAL SPECULUM - STERILE	Minimum order
29976	CUSCO Speculum - small 85 x 20 mm	box of 120
29977	CUSCO Speculum - medium 90 x 28 mm	box of 120
29978	CUSCO Speculum - large 100 x 36 mm	box of 108

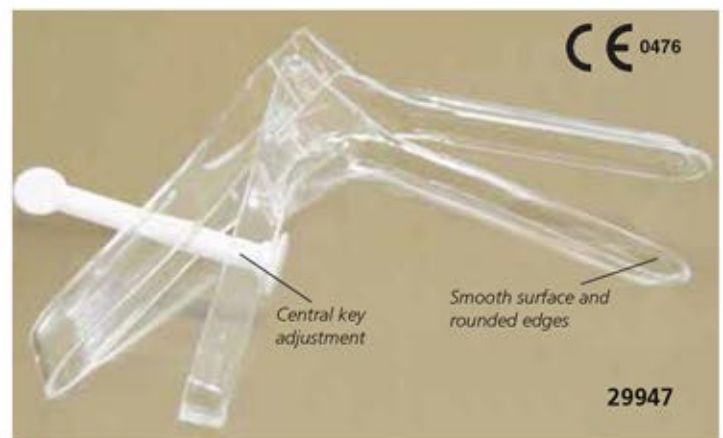

PERNO SPECULUM - with central key adjustment

For dilation of the vaginal canal to expose the uterus neck. It allows the adjustment of the vaginal opening by positioning the blades and locking the central key. The smooth surface and rounded edges aid a comfortable introduction. The central key can be bent down for an easier introduction of cumbersome instruments. Available 3 sizes distinguishable through key colour. Made in Europe.

code	PERNO VAGINAL SPECULUM - STERILE	Minimum order
29946	PERNO Speculum - small Ø 20 mm	box of 120
29947	PERNO Speculum - medium Ø 26 mm	box of 120
29948	PERNO Speculum - large Ø 30 mm	box of 120

STAINLESS STEEL VAGINAL SPECULUM - CUSCO AND COLLIN



code	STAINLESS STEEL SPECULUM
29770	Cusco stainless steel speculum - small 75x32 mm
29771	Cusco stainless steel speculum - medium 85x35 mm
29772	Cusco stainless steel speculum - large 100x37 mm
29773	Cusco stainless steel speculum - virgin 75x17 mm
29763	HF Cusco stainless steel speculum - medium with insulation for HF applications and suction connector
29768	Collin stainless steel speculum - medium 100x35 mm

STERILE PAP TEST KITS

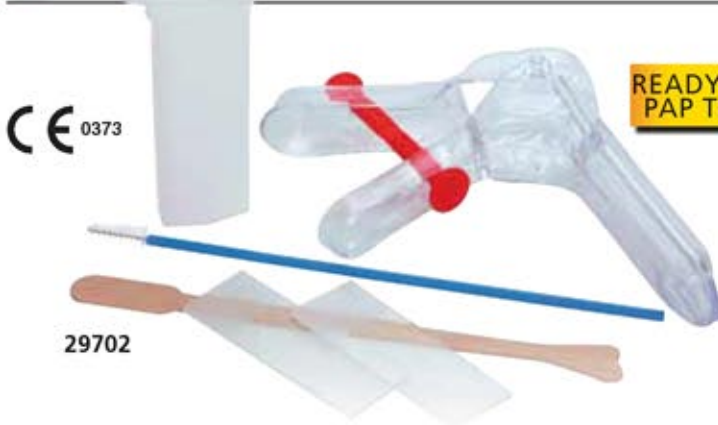

CE 0373

29702

READY TO USE
PAP TEST KIT

• **29702 PAP TEST KIT - sterile - box of 100 pcs.**
Pap-Test is a painless examination to detect the presence of any anomalous cells on the cervix. It allows an early diagnosis of uterus neck cancer. The functional configuration of the kit allows a ready to go operation. The kit includes: two latex gloves, one perno speculum (medium size), one brush, one Ayre spatula (wooden), two slides and one box for them. Individually packed in sterile pouch.



CE 0476

29704

• **29704 PAP TEST KIT - sterile - box of 50 pcs**
The kit includes: one pair latex glove, one side-screw speculum (medium size), one GIMA brush ball, one Ayre spatula A size (wooden), two slides. Individually packed in sterile pouch.

• **29703 PAP TEST KIT - sterile - box of 100 pcs**
Same as 29702 but without speculum.

29703

LUBRIGIMA: LUBRICANT GEL

• **29960 LUBRIGIMA - 250 ml**
Facilitates instruments insertion during gyn. examinations. Its special composition and high transparency do not alter the visual image when optical instruments are used. It does not contain spermicides and does not grease or stain. It has acid Ph and good electrical conductivity. Water soluble. Well absorbed by the skin, does not irritate the mucosa. LATEX FREE.



29960

KLY LUBRICATING GEL

• **29957 KLY LUBRICATING GEL**
sachet 5 g - box of 100
• **29959 KLY LUBRICATING GEL**
tube 82 g - 1 tube
• **29958 KLY LUBRICATING GEL**
tube 42 g - sterile and paraben-free - 1 tube
Hypoallergenic lubricating gel, does not irritate skin, dissolves in water and is easily cleaned. It does not contain oil or oily substances. It has no toxic effects or odour. It is used in endoscopy, gastroscopy, colonoscopy and rectoscopy.



Each 100 g contains 14 g of glycerine and preservatives



29959

Multilanguage box and manual (29958-9 only): GB, FR, IT, DE, PT, GR, TR, Arabic

TRAVEL ENEMA



28720

Vaginal cannula

Anal cannula

Tap

• **28720 TRAVEL ENEMA - 2 l capacity**
Supplied in cardboard box with 2 cannulas (vaginal, anal), tap with opening lever, tube and carrying bag. Multilanguage box: GB, FR, IT, ES.



PROCTOSCOPE

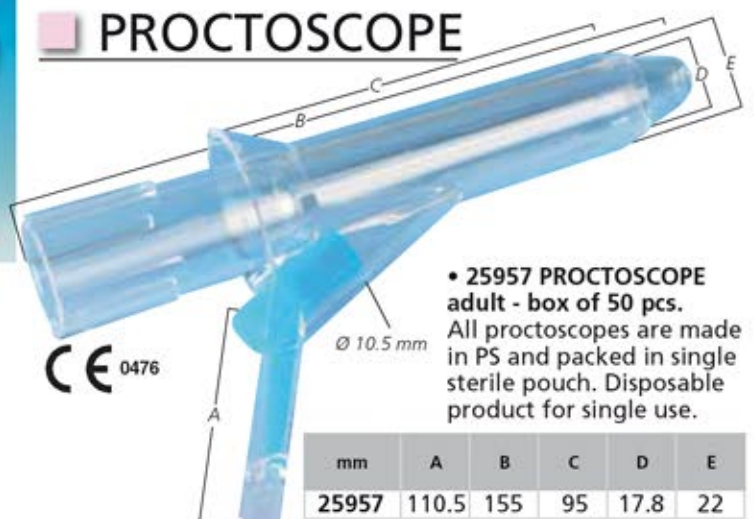

CE 0476

• **25957 PROCTOSCOPE adult - box of 50 pcs.**
All proctoscopes are made in PS and packed in single sterile pouch. Disposable product for single use.

mm	A	B	C	D	E
25957	110.5	155	95	17.8	22

AYRE SPATULA - BIRCH WOOD



Image showing Ayre spatula A (code 29743) and its sterile packaging (code 29745). The packaging is labeled "Spatula di ayre sterile in legno" and "CE 0123".

code	AYRE SPATULA - WOOD	Length	Minimum order
29743	Ayre Spatula A 5 box of 100 pcs = of 500 pcs	18 cm	500 pcs.
29745	Sterile Ayre Spatula A Individually packed in sterile pouch, in box of 100	18 cm	100 pcs.

AYRE SPATULA - PLASTIC



Image showing Ayre spatula B (code 29748) and Ayre spatula A (code 29749). A note states: "Used for ecto-cervical and posterior fornix cells sampler in uterus neck cancer screening procedures." (code 29746).

code	AYRE SPATULA - PLASTIC	Material	Length	Minimum order
29746	Ayre Spatula Packed in plastic bags of 25 pcs., in carton of 400 pcs.	PP	22 cm	400 pcs.
29748	Sterile Ayre Spatula A Individually packed in sterile pouch, in box of 100	PP	18.8 cm	100 pcs.
29749	Sterile Ayre Spatula B Individually packed in sterile pouch, in box of 100	PP	18.8 cm	100 pcs.

GIMA BRUSH - MADE IN ITALY



Image showing Gima brush (code 29742) in its sterile pack. The brush has a diameter of 6 mm and a length of 20 cm. CE mark 0123 is visible.

- 29739 GIMA BRUSH - conical - bag of 25 pcs.
- 29740 GIMA BRUSH - conical - box of 400 pcs.

These single-use endocervical brushes are an efficient method of collecting vulval, endocervical and nasal surface samples for cytological/microbiological examinations. Non sterile. Packed in plastic bags of 25 units, in carton of 400 units.

- 29742 GIMA BRUSH - conical - STERILE - box of 500 pcs

As code 29740, individually packed in sterile plastic bag. Both codes are made in Italy.

GIMA BRUSH - STERILE

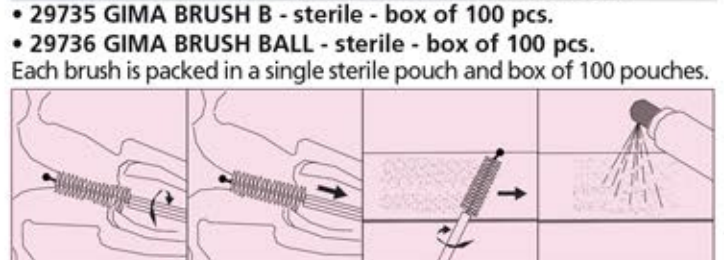

Image showing Gima brush B (code 29735) and Gima brush ball (code 29736). A note states: "Special 'ball' to avoid cervix puncture and patient pain during the procedure". Each brush is packed in a single sterile pouch and box of 100 pouches.

- 29735 GIMA BRUSH B - sterile - box of 100 pcs.
- 29736 GIMA BRUSH BALL - sterile - box of 100 pcs.

Each brush is packed in a single sterile pouch and box of 100 pouches.

These single-use endocervical brushes are an efficient method of collecting vulval, endocervical and nasal surface samples for cytological/microbiological examinations. Non sterile. Packed in plastic bags of 25 units, in carton of 400 units.



COTTON SWABS



Image showing various cotton swabs: 29753 (sterile swab stick), 29754 (cotton swab), 29756 (cotton swab), and 29750 (cotton swab). A label on the swab stick says "Label to write patient data".

code	COTTON SWABS	Shaft Material	Cotton Ø	Shaft length	Minimum order
29750	Cotton Swab	Plastic	1 cm	20 cm	400 pcs.
	Packed in plastic bags of 25 pcs., in carton of 400 pcs.				
29753	Sterile Cotton Swab	Plastic	0.5 cm	15 cm	100 pcs.
	Packed in box of 100 pcs.				
29754	Cotton Swab	Wood	0.5 cm	15 cm	1,000 pcs.
	Packed in plastic bags of 100 pcs., in carton of 1000 pcs.				
29756	Cotton Swab	Wood	1 cm	15 cm	500 pcs.
	Packed in plastic bags of 50 pcs., in carton of 500pcs.				

WALLACH PAPETTE, GIMA COLLECTOR

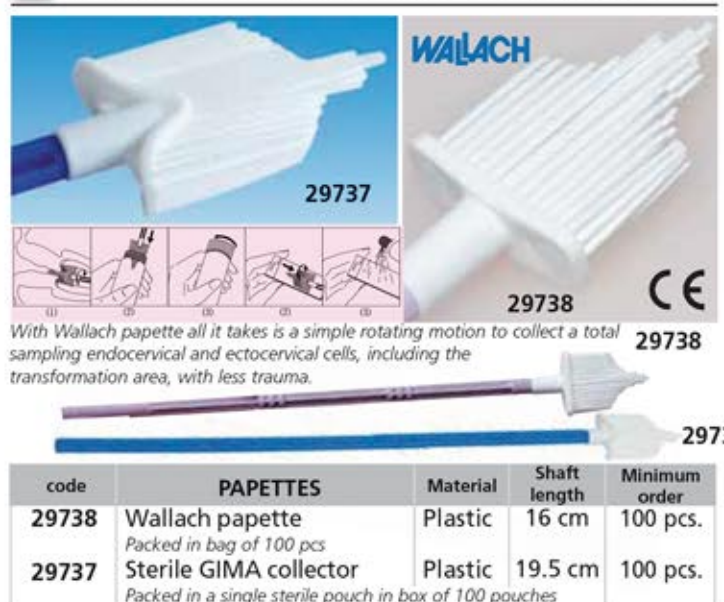

Image showing Wallach papette (code 29737) and Gima collector (code 29738). A note states: "With Wallach papette all it takes is a simple rotating motion to collect a total sampling endocervical and ectocervical cells, including the transformation area, with less trauma." (code 29738).

code	PAPETTES	Material	Shaft length	Minimum order
29738	Wallach papette	Plastic	16 cm	100 pcs.
	Packed in bag of 100 pcs			
29737	Sterile GIMA collector	Plastic	19.5 cm	100 pcs.
	Packed in a single sterile pouch in box of 100 pouches			

"KARMAN" AND "BERKELEY" INTRAUTERINE SUCTION CURETTES



Length 24 cm with connector, 20.5 cm without



Length 20 cm with connector, 17 cm without

code	"KARMAN" STYLE CURETTES FLEXIBLE - SINGLE USE - STERILE	Minimum order
29858	Karman Curette N° 4 - 4 mm x 24 cm	box of 20
29859	Karman Curette N° 5 - 5 mm x 24 cm	box of 20
29860	Karman Curette N° 6 - 6 mm x 24 cm	box of 20
29861	Karman Curette N° 7 - 7 mm x 24 cm	box of 20
29862	Karman Curette N° 8 - 8 mm x 24 cm	box of 20
29863	Karman Curette N° 9 - 9 mm x 24 cm	box of 20
29864	Karman Curette N° 10 - 10 mm x 24 cm	box of 20
29865	Karman Curette N° 11 - 11 mm x 24 cm	box of 20
29866	Karman Curette N° 12 - 12 mm x 24 cm	box of 20

code	"BERKELEY" STYLE CURETTES CURVED - RIGID - SINGLE USE - STERILE	Minimum order
29870	Berkeley Curette N° 7 - Ø 7 mm x 20 cm	box of 20
29871	Berkeley Curette N° 8 - Ø 8 mm x 20 cm	box of 20
29872	Berkeley Curette N° 9 - Ø 9 mm x 20 cm	box of 20
29873	Berkeley Curette N° 10 - Ø 10 mm x 20 cm	box of 20
29874	Berkeley Curette N° 11 - Ø 11 mm x 20 cm	box of 20
29875	Berkeley Curette N° 12 - Ø 12 mm x 20 cm	box of 20

- 29918 SUCTION SYRINGE - 60 ml - one-way self-blocking valve
Syringe with adaptor for use with Karman and Berkeley curettes.



CANNULAS FOR ENDOMETRIAL SAMPLING

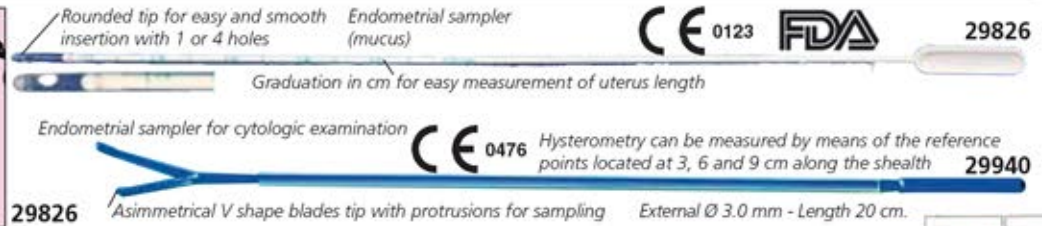
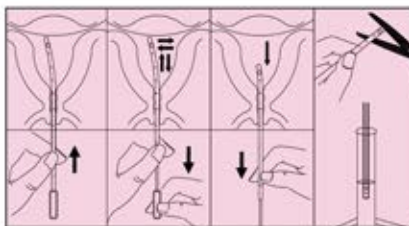

- 29826 PIPELLA 1 hole - disposable, sterile - box of 100
 - 29827 PIPELLA 4 holes - disposable, sterile - box of 100
- For endometrial cytologic sampling. It allows a painless and easy routine screening of the endometrium avoiding dilation and traction of the uterus neck.
Hole: Ø 2.0-2.5 mm
External diameter: 3.1 mm
Length of cannula: 23.5 cm
Length of handle: 26.5 cm

- 29940 ENDOGYN - disposable, sterile - box of 25
- For cytologic endometrial sampling. It allows a painless and easy routine screening of the endometrium avoiding dilation and traction of the uterus neck. An outer sheath covers a mandrel with asymmetrical "V" shaped blades on the top. Each arm features fine toothings and thin cutting edges which are able to remove and keep more endometrial tissue. The head of one of the two arms features a hemispherical head which, when it goes back inside the sheath, allows for previously removed tissue to be aspirated.

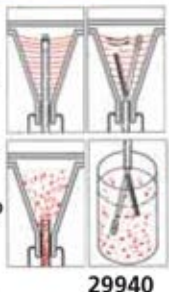

FLEXIBLE HYSTEROMETERS - SINGLE USE - STERILE

With slider	Without slider	HYSTEROMETER SINGLE USE - STERILE - LATEX FREE	Minimum order
29930	29933	Hysterometer CH 10 - 29 cm	25 pcs.
29931	29934	Hysterometer CH 12 - 29 cm	25 pcs.
29932	29935	Hysterometer CH 14 - 29 cm	25 pcs.

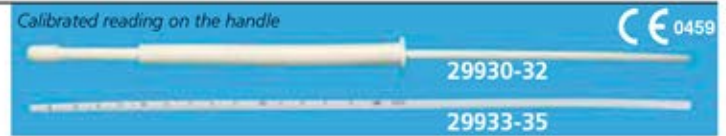

SPRAY FOR CITOTOLOGY FIXATION AND SLIDES



29775

29777

29775

29774

code	MICROSCOPE SLIDES Size 76x26 mm, 1.0-1.2 mm thick 45° corners minimum order: pack of 200 pcs. (4 boxes of 50 pcs.)
29774	Plain side, ground edges
29775	Single end frosted, sandblasted band, ground edges
29777	Twin frosted in both ends, ground edges, sandblasted band



29776

- 29776 BOX FOR SLIDES
Plastic, transparent box for storage of up to three slides.

- 29778 GIMAFIX SPRAY FOR CITOTOLOGY FIXATION
Fixer for cytology. Composition: isopropanole, poly-ethylenglycole. It does not contain propellants deleterious for the ozone. 250 cc bottle.

minimum order: 12 bottles



PREGNANCY TESTS: MIDSTREAM AND STRIP TYPE



SELF TEST

CE 0197

Extra early detection 3 days before you miss your period

Shelf life 36 months

29104 Large wipe reduce risk for false results

29103

29108

29100

GIMA offers a complete line of pregnancy tests, both for OTC market (self test) and for professional use in hospital or doctor's cabinets.

All products are packed in cardboard boxes with multilingual user manual (GB, IT, ES, FR, GR, PT).

Main features of pregnancy tests:

- each test is individually packed in sealed pouch
- very quick, in 3 minutes. Some positive can be detected in 1 min
- early detection: it can be used since the first day you miss your period (three days before for 29103)
- reliability: 99%
- sensitivity:

25 mIU/ml (29100, 29104, 29107, 29108) - 1 min

10 mIU/ml (29103) - 3 min

- Clinically tested



code	PREGNANCY TESTS	Type	Package
29103	SELF TEST	midstream (large wipe)	box of 1 pc
29104	SELF TEST	midstream	box of 1 pc
29107	SELF TEST	midstream	box of 2 pcs
29108	PROFESSIONAL TEST	midstream	box of 25 pcs
29100	PROFESSIONAL TEST	strip 4 mm	box of 50 pcs

PERSONALIZED BOX, MANUAL AND APPROVAL CE 0197 FOR SELF TEST minimum 3000 pcs.

OVULATION AND FERTILITY TESTS



SELF TEST

SELF TEST

29112

29114

29113

OVULATION - FERTILITY TEST:

Easy to use test for professional use or OTC self test market. Early detection test, 99,9% accurate and clinically tested. Sensitivity: 40 mIU/ml.

All products are packed in cardboard boxes with multilingual user manual (GB, IT, ES, FR, GR, PT).

code	OVULATION TESTS	Type	Package
29112	SELF TEST	midstream	box of 5 pcs
29114	SELF TEST	strip 4 mm	box of 6 pcs
29113	PROFESSIONAL TEST	strip 4 mm	box of 50 pcs

- 29131 DISPLAY - English - empty
 - 29130 DISPLAY - Italian - empty
- Display is suitable for all "gynaecology" self tests.



PREGNANCY DISC

YOUR LOGO HERE minimum 1,000 pcs.



- 29099 PREGNANCY DISC
- Forecasts the forthcoming date of birth. Used by obstetrician and practitioners. Useful for assessment of drug administration. 2 rotating discs riveted in the center: 108 mm diameter (base), 76 mm diameter (top). Can be personalized with your logo for minimum 1,000 pcs.

SEE BASAL THERMOMETER FOR FERTILITY CONTROL - PAGE 78

CHLAMYDIA RAPID TEST

• **29117 CHLAMYDIA TEST** - box of 20 tests
Provide accurate results in 10 minutes, giving doctors immediate diagnosis. High sensitivity and specificity. Each box includes 20 tests, reagents, female cervical swabs, tubes, droppers, pipette and user manual. For professional use.



CE 0123

- Male/Female swab specimen**
- Add reagent A and B to specimen
 - Add 3 drops of extracted specimen
 - Read results after 10 minutes
- Male urine specimen**
- Add reagent B and A to specimen
 - Add 3 drops of extracted specimen
 - Read results after 10 minutes

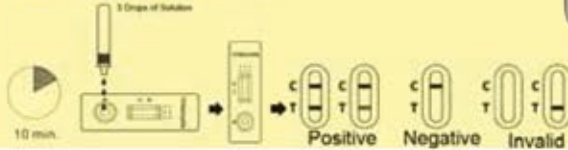

CANDIDA ALBICANS TEST

• **29105 CANDIDA TEST** - box of 20 tests
Rapid, immunochromatographic test on vaginal smear. Easy to perform, able to identify by specific antibodies the presence of Candida in only 10 to 20 minutes. Validated by external studies, found to have a sensitivity of over 98% and specificity of over 94% when compared with reference methods for microbes identification (such as BD Affirm, USA). The reproducibility is at the highest level of rapid tests. As Candida affects 50% of women at least once in their life and symptoms can be mistaken for those of Bacterial Vaginosis or other Vaginitis, the use of this test together with the vaginal pH test (see code 29110) allows discriminate between the two. For professional use.



CE

VAGINITIS TEST KIT

The test includes:
1 test + vaginal swab + fluid specimen (buffer solution) in single box + English/Italian manual

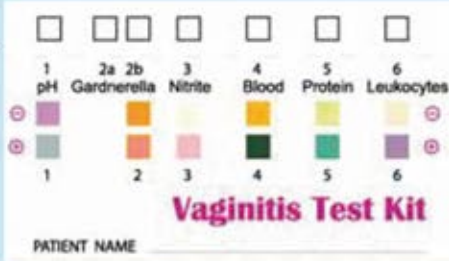

Vaginitis Test Kit

PATIENT NAME _____

CE

• **29111 VAGINITIS TEST KIT**
A unique, easy-to-use and revolutionary test for gynecologists and operators. Finds the causes of the inflammation/vaginal infection in just 10 minutes. It replaces traditional bacterial tests that take days and costs only a tenth. When necessary dilute vaginal fluid specimen in a buffer solution and then transfer to reagent pad. The instruction manual contains a result guide and can be used to recognize: Trichomoniasis, negative gram bacteria, Gardnerella, Chlamydia, serious bacterial vaginitis. For professional use.

VAGINAL PH TEST

The kit contains:
10 cotton swabs + 10 reagent strips in an individual box with user manual (English + Italian)



CE

• **29110 VAGINAL PH TEST** - box of 10 pcs.
Quick test to determine vaginal PH. An easy routine test to check vaginal PH in just 1 minute to make sure it is within the physiological limits (< 4.7). An increase in the Ph level may indicate a change in the vaginal environment. This could mean there is a possible vaginitis. The test is ideal for pregnant women and for women with particular diseases such as diabetes. For professional use.

RUBBER AND SILICONE PESSARY FOR UTERINE PROLAPSE - LATEX FREE



RUBBER PESSARY



SILICONE PESSARY

BLUE SILICONE PESSARY

Individually packed in cardboard box with English user manual



29965

29895

29905

code	RUBBER PESSARY - autoclavable*
29882	Rubber Pessary Ø 55 mm
29963	Rubber Pessary Ø 60 mm
29964	Rubber Pessary Ø 65 mm
29965	Rubber Pessary Ø 70 mm
29966	Rubber Pessary Ø 75 mm
29967	Rubber Pessary Ø 80 mm
29968	Rubber Pessary Ø 85 mm
29969	Rubber Pessary Ø 90 mm
29884	Rubber Pessary Ø 95 mm
SILICONE PESSARY - autoclavable*	
29892	Silicone Pessary Ø 55 mm
29893	Silicone Pessary Ø 60 mm
29894	Silicone Pessary Ø 65 mm
29895	Silicone Pessary Ø 70 mm
29896	Silicone Pessary Ø 75 mm
29897	Silicone Pessary Ø 80 mm
29898	Silicone Pessary Ø 85 mm
29899	Silicone Pessary Ø 90 mm
29900	Silicone Pessary Ø 95 mm
BLUE SILICONE PESSARY - autoclavable*	
29905	Blue silicone Pessary Ø 70 mm
29906	Blue silicone Pessary Ø 75 mm
29907	Blue silicone Pessary Ø 80 mm

*Autoclavable at 121°C/15 min or 134°C/10 min for up to 3 times

DIATERMO MB 122 AND MB 160 MONO-BIPOLAR - 120 W - 160 W



- 30538 DIATERMO MB 122 VALUE* - mono-bipolar - 120 W
- 30540 DIATERMO MB 122 - mono-bipolar - 120 W
- 30541 DIATERMO MB 160 - mono-bipolar - 160 W

MB 122 and 160 are HF electrocautery units suitable to perform middle monopolar or bipolar electrocautery.

By selection of the modes of operation they provide pure cut, coagulated cut, forced coagulation, soft coagulation and, with forceps, bipolar coagulation. The use of either split or normal neutral plate is allowed. MB 160 is recommended in case of damp operational fields, for instance mucous, with consequent need to have reserve of usable power. For these reasons, MB 160 is suggested for Gynecological and orthopedic surgery.

Leading-Edge Technology. This advanced concept device enables highly professional surgery intervention thanks to ergonomic and safety features derived from high power theatre apparatus.

Complete safety. Open Circuit (OC) Alarm warns the user that connection into the neutral plate has not been made or that the cable is disconnected or the neutral plate is not in contact with the patient. The alarm is signaled by an intermittent beep together with a flashing red light on the front panel. In this case HF emission for cut and coagulation operation is switched off.

OVT Alarm. The unit includes an internal circuit protection warning when the current delivery is exceeding.

STANDARD ACCESSORIES

- MB single-use two button handle
- MB operative foot-switch 30577 (usable as alternative to handle) (30540-1 only)
- MB flat neutral plate with cable 30564 (30540-1 only) Power cable 2 m
- Kit of 6 (MB 122) or 10 (MB 160) short autoclavable electrodes, diam. 2.4 mm
- User manual: available in GB, ES, IT, FR, PL

*Does not include foot switch and MB flat neutral plate with cable

TECHNICAL SPECIFICATIONS

	MB122	MB160	Crest Factor
Minimum preselectable power	0	0	
Level step	1	1	
Maximum output power CUT (W)	120 250Ω	160 250Ω	1.5
Maximum output power BLEND (W)	90 200Ω	120 200Ω	2.1
Maximum output power COAG FORCED (W)	80 150Ω	100 150Ω	2.0
Maximum output power COAG SOFT (W)	60 100Ω	80 100Ω	1.7
Maximum output power BIPOLAR (W)	40 100Ω	60 100Ω	1.5
Working frequency	600 kHz	600 kHz	
Weight kg	7	7	
Size LxHxD mm	260x110x265	260x110x265	
Operating voltage (switchable)	115 -230	115 -230	
Mains frequency (Hz)	50-60	50-60	
Fuses 230Vac (5x20) TIMED	2x 3.15A	2x 3.15A	
Fuses 115Vac (5x20) TIMED	2x 6.3A	2x 6.3A	
Electrical input power (VA)	300	350	
Electrical input current (230 Vac) (A)	1.3	1.5	
Electrical input current (115 Vac) (A)	2.6	3	
Five steps adjustable sound level (from 55- to 75dBA)	•	•	
Self-check	•	•	
Power accuracy output warning	•	•	
Split or not split patient plate allowed	•	•	
Last working condition storing	•	•	
Electrical Class (EN60601 - 1)	I CF	I CF	
MDD 93/42/EEC Class	II b	II b	
Patient circuit	F	F	

MONOPOLAR ELECTROSURGERY UNIT - 50 W



- 30516 DIATERMO 106 - 50W - monopolar

This HF electrocautery unit is particularly suitable for small operations and is recommended for dentistry, first aid and dermatology work. It offers precision of cut and immediate coagulation and give excellent results in a wide range of applications: from uterine coagulation to microcoagulation in dermatology. The modes of operation, CUT, COAG or

TECHNICAL SPECIFICATIONS

Output power: CUT	50 W/400 ohm
COAG	40 W/400 ohm
BLEND	45 W/400 ohm
Working frequency:	600 kHz ±10%
Size: 180x180x100 mm	Weight: 2.8 kg
Operating Voltage: 115/230 V - 50/60 Hz switchable	
Electric input power: 90 VA	Fuse: 2x1 AT
Alarm for overheating	Footswitch operating
Norms: EN60601-1 Class I CF, EN60601-2-2 93/42/EEC (Class IIb)	
Made in Italy	Warranty: 12 months

STANDARD ACCESSORIES

- KIRKY single-use handle without buttons
- Standard foot-switch (30577)
- Flat neutral plate with cable (30564)
- Kit of 6 short autoclavable electrodes, Ø 2.4 mm, length 5 cm
- Power cable 2 m - Schuko plug
- User manual: available in GB, IT, ES, FR

CE 0051

BLEND, can be easily selected by a switch on the front panel. The complete isolation between patient and the unit and strict respect of international norms guarantee total safety.

MONO-BIPOLAR ELECTROSURGICAL UNITS 80W, 120W, 160W



CASUALTY SURGERY
PEDIATRIC SURGERY*
PLASTIC SURGERY*
VASCULAR SURGERY
DERMATOLOGY
FIRST AID
OTORHINOLARYNGOLOGY
UROLOGY*
GYNAECOLOGY
VETERINARY
DENTISTRY**

*Diatermo MB160 only
**Diatermo MB120 only



- 30627 DIATERMO MB 80D - mono-bipolar - 80 W
 - 30628 DIATERMO MB 120D - mono-bipolar - 120 W
 - 30629 DIATERMO MB 160D - mono-bipolar - 160 W
- Diatermo MB are high frequency electrosurgical units suitable for minor and medium surgery.

MB allow pure CUT, cut-coagulation BLEND, superficial coagulation FORCED COAG, deep coagulation in absence of necrosis SOFT COAG and, with forceps, BIPOLAR coagulation. The digital reading of delivered power and the monitoring of operative function by microcontroller guarantees absolute reliability of working conditions.

MB allow a highly professional surgery through ergonomic and safety features. The connection of neutral electrode is constantly monitored. Safety control of patient/plate contact using split neutral electrode.

Possibility to control the output functions and the delivery of output power by the handle, allows the surgical operation without diverting attention from the surgical field.

Features:

- minimum invasive surgery
- possibility to use bipolar forceps
- possibility to use split neutral electrodes
- memorization of the last used settings
- power activation by pedal and/or handle
- digital adjustment and indication of the output power
- adjustment of the acoustic indicator intensity.



TECHNICAL SPECIFICATIONS

	MB 80D	MB 120D	MB 160D
Max output power CUT	80 W-250 Ω	120 W-250 Ω	160 W-250 Ω
Max output power BLEND	60 W-250 Ω	90 W-200 Ω	120 W-200 Ω
Max output power FORCED COAG	50 W-150 Ω	80 W-150 Ω	100 W-150 Ω
Max output power SOFT COAG	40 W-100 Ω	60 W-100 Ω	80 W-100 Ω
Max output power BIPOLAR	30 W-100 Ω	40 W-100 Ω	60 W-100 Ω
Working frequency	600 kHz	600 kHz	600 kHz
Patient circuit	F	F	F
Selectable input voltage	115 - 230 Vac	115 - 230 Vac	115 - 230 Vac
Mains frequency	50 - 60 Hz	50 - 60 Hz	50 - 60 Hz
Electrical input power	230 VA	300 VA	350 VA
Size WxHxD mm	254x104x288	254x104x288	254x104x288
Weight	5 kgs	5 kgs	5 kgs
Controls:	Patient/Plate circuit monitoring, Output power monitoring, Self check control		
Safety:	EN60601-1, EN60601-1-2, EN60601-2-2, Electrical Class: I CF, MDD 93/42/EC Class: II b		

STANDARD ACCESSORIES

MB single use two button handle
Waterproof foot-switch 30577 (usable as alternative to handle)
MB flat neutral plate with cable (30564)
Kit of 10 short autoclavable electrodes, diam. 2.4 mm. Power cable: 2 m
User manual: GB, IT, available on request FR, ES, PL

MONOPOLAR ELECTROSURGERY UNITS 50W AND 80W



DENTISTRY
DERMATOLOGY
OUT PATIENT SURGERY
FIRST AID
VETERINARY*
VASCULAR SURGERY*

*Diatermo 80 only

TECHNICAL SPECIFICATIONS

	50	80
Max output power CUT	50 W-400 Ω	80 W-400 Ω
Max output power CUT/COAG1	45 W-400 Ω	-
Max output power CUT/COAG2	40 W-400 Ω	-
Max output power BLEND	-	60 W-400 Ω
Max output power COAG	40 W-400 Ω	50 W-400 Ω
Max output power MICRO	-	20 W-600 Ω
Working frequency	600 kHz	700 kHz
Patient circuit	F	F
Selectable input voltage	115 - 230 Vac	115 - 230 Vac
Mains frequency	50 - 60 Hz	50 - 60 Hz
Electrical input power	200 VA	230 VA
Size WxHxD mm	190x85x239	190x85x239
Weight	2.5 kg	2.5 kg
Controls:	Patient/Plate circuit monitoring, Output power monitoring, Self check control	
Safety:	EN60601-1, EN60601-1-2, EN60601-2-2, Electrical Class: I CF, MDD 93/42/EC Class: II b	

- 30625 DIATERMO 50 - monopolar
 - 30626 DIATERMO 80 - monopolar
- DIATERMO 50 and 80 are radiofrequency electrosurgical units suitable for minor monopolar surgery. Diatermo 50 through the function selection makes pure cut, cut coagulation (CUT 1 - CUT 2) and pure coagulation possible. Diatermo 80 has a multifunction selector which makes cutting (CUT), cut coagulation (BLEND), coagulation (COAG) and micro-coagulation (MICRO) possible. The one-board microcontroller and digital display guarantee high safety and reliability under any conditions. They offer outstanding professional surgical results due to their ergonomic and superior safety features.



STANDARD ACCESSORIES

Single use handle
Waterproof foot-switch (30577)
MB flat neutral plate with cable (30564)
Kit of 6 short autoclavable electrodes, Ø 2.4 mm, length 5 cm (30501/2/4/7/9/10) see page 187
Power cable 2 m - Schuko plug
User manual: GB, IT, available on request FR, ES

MONO-BIPOLAR ELECTROSURGICAL UNIT 200W



OUTPATIENT SURGERY
ENDOSCOPY
FIRST AID
GASTROENTEROLOGY
GENERAL SURGERY
GYNAECOLOGY
NEUROSURGERY
ORTHOPEDICS
OTORHINOLARYNGOLOGY
PEDIATRIC SURGERY
PLASTIC SURGERY
PNEUMOLOGY
UROLOGY
VASCULAR SURGERY
VETERINARY

• 30630 DIATERMO MB 200D - 200 W

MB 200D is a high frequency electrocautery equipment suitable for light and medium surgery, allows minimally invasive surgical procedure of resection, evaporation and coagulation. MB 200D allows pure CUT, Cut-Coagulation BLEND, incision with reduced production of eschar ENHANCED, superficial coagulation FORCED COAG, deep coagulation in absence of necrosis SOFT COAG and BIPOLAR coagulation. Digital reading of delivered power and surveillance through microcontroller of the operational functions, assure absolute reliability of working conditions.

MB 200D allows a highly professional surgery through ergonomic and safety features. The connection of neutral electrode is constantly monitored. Safety control of patient/plate contact using split neutral electrode. Possibility to control the output functions and the delivery of output power by the handle, allows the surgical operation without diverting attention from the surgical field.

- patient-to-plate contact control
- split return electrode use

STANDARD ACCESSORIES

MB two-button autoclavable handle (30536)
Waterproof MB foot-switch (30577)
MB flat neutral metal plate with cable (30564)
Kit 10 short standard electrodes, diam. 2.4 mm
3 needle + 3 blade + 3 ball electrodes 7 cm
Power cable 5 m
Manual: available in GB, IT

- minimally invasive surgical treatment allowed
- monopolar and Bipolar independent output
- auto Start/Stop in Bipolar Coag
- working condition planning
- power delivery by pedal and/or handle
- digital regulation and indication of the output power
- sound level control
- adjustable power increment



CE 0051

TECHNICAL SPECIFICATIONS

Maximum output power CUT	200W - 250Ω
Maximum output power ENHANCED	120W - 250Ω
Maximum output power BLEND	120W - 200Ω
Maximum output power FORCED COAG	150W - 150Ω
Maximum output power SOFT COAG	90W - 100Ω
Maximum output power BIPOLAR COAG	80W - 50Ω
Working frequency	600 kHz
Patient circuit	F
Mains voltage	115-230 Vac
Mains frequency	50-60 Hz
Electrical input power	350 VA
Size WxHxD mm	370x144x319
Weight	6 kgs
Controls:	Patient/Plate circuit monitoring, Output power monitoring, Self check control
Safety:	EN60601-1, EN60601-1-2, EN60601-2-2, Electrical Class: I CF, MDD 93/42/EC Class: II b

DIATERMO MB 200 - MONO-BIPOLAR - 200W



30542

DIATERMO MB 200 - STANDARD ACCESSORIES

MB two-button autoclavable handle (30536)
MB waterproof foot-switch 30577 (usable in alternative to handle)
MB flat neutral metal plate with cable (30564)
Kit 10 short standard electrodes, diam. 2.4 mm
Power cable 2 m
Manual: available in GB, IT

CE 0051

TECHNICAL SPECIFICATIONS

Maximum output power CUT (W)	200	250Ω	Crest factor	1.5	Weight kg	8
Maximum output power CUT 90% (W)	200	250Ω		1.6	Size LxHxD mm	360x150x265
Maximum output power CUT 80% (W)	200	250Ω		1.7	Selectable mains power(Vac)	115 - 230
Maximum output power CUT 70% (W)	200	250Ω		1.8	Mains frequency (Hz)	50-60
Maximum output power BLEND (W)	120	200Ω		2.1	Fuses 115Vac - 230Vac (5x20) TIMED	2x 6.3A - 2x 3.15A
Maximum output power COAG FORCED (W)	150	150Ω		2.0	Power accuracy output warning system	•
Maximum output power COAG SOFT (W)	90	100Ω		1.7	Split or not split patient plate allowed	•
Maximum output power BIPOLAR COAG (W)	100	100Ω		1.5	Electrical Class (EN60601 - 1)	I CF
Maximum output power BIPOLAR CUT (W)	120	250Ω		1.5	MDD 93/42/EEC Class	II b
Working frequency	600 kHz				Patient circuit	F
					Duty cycle (action/pause) in seconds	10/30

MONOPOLAR AND BIPOLAR ELECTROSURGICAL UNITS 120W AND 200W



- 30631 DIATERMO MB 120 FLASH
- 30633 DIATERMO MB 200 FLASH

MB FLASH are a High Frequency ElectroSurgical equipment suitable for precision monopolar and bipolar surgery and micro-surgery without tissue alterations.

MB FLASH allow surgical treatments with programmable timer operations up to milliseconds or with traditional mode.

MB FLASH allow pure CUT, cut-coagulation BLEND, incision with reduced production of eschar ENHANCED, superficial coagulation FORCED COAG, deep coagulation in absence of necrosis SOFT COAG and BIPOLAR coagulation. Digital reading of delivered power and the surveillance through microcontroller of the operational functions, assure absolute reliability of the working conditions.

MB FLASH allow a highly professional surgery through ergonomic and safety features.

TECHNICAL SPECIFICATIONS

	MB 120F	MB 200F
Max output power CUT	120 W-250 Ω	200 W-250 Ω
Max output power BLEND	90 W-200 Ω	120 W-200 Ω
Max output power ENHANCED	90 W-250 Ω	120 W-250 Ω
Max output power FORCED COAG	80 W-150 Ω	150 W-150 Ω
Max output power SOFT COAG	60 W-100 Ω	90 W-100 Ω
Max output power BIPOLAR COAG	60 W-50 Ω	80 W-50 Ω
Working frequency	600 kHz	600 kHz
RF power pulse emission time	10ms - 30sec	10ms - 30sec
RF power pulse interval	1 - 9	1 - 9
Patient circuit	F	F
Selectable input voltage	115 - 230 Vac	115 - 230 Vac
Mains frequency	50 - 60 Hz	50 - 60 Hz
Electrical input power	300 VA	350 VA
Size WxHxD mm	370x144x319	370x144x319
Weight	6 kg	6 kg
Controls: Patient/Plate circuit monitoring, Output power monitoring, Self check control		
Safety: EN60601-1, EN60601-1-2, EN60601-2-2, Electrical Class: I CF, MDD 93/42/EC Class: II b		

Connection of neutral electrode is constantly monitored.

Safety control of patient/plate contact using split neutral electrode. Possibility to control the output functions and the delivery of output power by handle, allows surgical operation without diverting attention from the surgical field.

Features:

- patient to plate contact control
- split return electrode use allowed
- minimally invasive surgical treatment allowed
- Monopolar and Bipolar independent output
- auto Start/Stop in Bipolar Coag
- working condition planning
- power delivery by pedal and/or handle
- digital regulation and indication of the output power
- sound level control
- adjustable power increment
- RF power pulse emission time setting
- RF power pulse interval setting



STANDARD ACCESSORIES

- MB two-button autoclave handle (30536)
- Waterproof MB footswitch (30577)
- MB flat neutral plate with cable (30564)
- 2 disposable ground pads (30562)
- Kit 10 short standard electrodes Ø 2.4 mm
- 3 needle + 3 blade + 3 ball electrodes 7 cm
- Power cable 5m
- Microsurgery handle (30552)
- Microsurgery needles 10 pieces
- Manual: GB, IT

CE 0051



ELECTRODEPILATOR

- 28340 ELECTRO-DEPILATOR 400

This device ensures a definitive depilation with thermolytic method. It delivers a current of radiofrequency to cause the heating and consequent coagulation of the papilla, reached through the introduction of a needle into the follicle of the hair. Provided with highly reliable electronic integrated components, with RF intensity adjustable with continuity and luminous working signal. It comes complete with footswitch, handpiece for depilation, depilation needle and power cable (2 m).

TECHNICAL SPECIFICATIONS

RF output frequency: 1.9 ±10% MHz	
Modulation: sinusoidal	
Maximum output power: 7 ±2Watt	
Size: 260x265xh 110 mm	Weight: 4 kg
Operating voltage: 115/230 V - 50/60 Hz switchable	
Norms: CEI 62-39 Class: I-BF	

- 30552 HANDPIECE FOR DEPILATION

- 30577 FOOTSWITCH

Depilation or microsurgery needles see page 187



HOSPITAL HF ELECTROSURGICAL UNITS 240 AND 380 WATT



30690

CONTEMPORARY DUAL MODE MB 240 and 380 can be used in the same time in monopolar mode (by handle) and bipolar mode (by footswitch)

A special electronic circuit (Skin Plate Electronic Control) continuously warns the plate to patient contact safety and unwanted short circuit in the connecting cable

- 30690 DIATERMO MB 240
- 30692 DIATERMO MB 380



These HF electrosurgical units can be used to execute monopolar and bipolar surgery when high precision and reliability are essential, as in the endoscopic surgery.

EASY TO USE

Graphic icons allow an easy selection of the operation mode. All operating conditions and selected output controls are represented by bright digital indications.

CUT

The monopolar cut can be performed by pure sine current to obtain an incision with a minimum damage for the adjacent tissues and sure recovery for first intention.

Two different modes of modulation allow to reduce bleeding during monopolar cut. In the bipolar mode the cut can be effected by pure sine current.

HEMOSTASIS

When the surgical action requires the obliteration of a blood vessel the availability of currents with different coagulative powers enables this type of work both with monopolar and bipolar surgery.

FULGURATION

When it is necessary to cause a superficial necrosis of wide areas, protecting the deeper tissues, a special coagulant current that dehydrates the superficial layer of the tissue and reduces the possibility to damage those beneath is available for the operation.

OUTPUT CONTROL

Output power levels are adjustable through incremental

encoders that allow the exact pre-sets and repetition of the values. The output function is linearized and controlled by ultra-modern electronic micro-controllers which will interrupt power if any alarm condition happens.

SAFETY OF USE

Circuits dedicated to the safety of operator and patient are the priority. This ensure the leakage current is kept well under the international requirements values, whatever the output condition. Monopolar and bipolar output circuits are completely floating and the use of the defibrillator is allowed while the reference plate patient is connected.

RELIABILITY

DIATERMO MB uses all solid state electronic circuits and is made with interchangeable units for a fast and effective maintenance. Automatic control circuits protect the units from damage also in case of repeated improper use.



30692

TECHNICAL SPECIFICATIONS DIATERMO MB 240/DIATERMO MB 380

Activation devices

Bipolar: footswitch
Dual: bipolar - footswitch
monopolar - manual
Monopolar: footswitch
manual
Mains: 115/230 Vac 50-60 Hz
Absorption: 800 VA
Class I CF
Weight: 15 kg
Size: 370x470x150 mm
Warranty: 12 months
(accessories not included)
Norms: IEC 601-2-2 - IEC 601-1
CE, 93/42/EEC

Monopolar output
Cut output
Cut/coag 1 output
Cut/coag 2 output
Coag 1 output
Coag 2 output
Coag 3 output (spray)
Bipolar output
Cut output
Coag output

Working frequency
475 kHz

Max power
240/MB 380
250W/375W
225W/340W
200W/300W
150W/225W
100W/150W
80W
90W
80W

Peak to peak voltage
1.4 kV
1.4 kV
1.4 kV
1.4 kV
1.4 kV
4.2 kV
0.5 kV
0.5 kV

Load resistance
300 Ohm
300 Ohm
300 Ohm
300 Ohm
300 Ohm
2000 Ohm
100 Ohm
100 Ohm

STANDARD ACCESSORIES

- 1 - Power supply cord SIEM-CEE 5 m
- 1 - Two-button autoclavable handle (30536)
- 5 - Two-button single use handle
- 1 - Cable for disposable plate
- 5 - Disposable plate
- 1 - Water proof double foot switch
- 3 - Short, general surgery blade electrode
- 3 - Long, general surgery blade electrode
- 3 - Short, general surgery needle electrode
- 3 - Short, general surgery ball electrode
- 1 - User manual (IT, GB, ES)
- 1 - Service manual (IT, GB)

LAPAROSCOPIC ELECTRODES



Laparoscopic electrodes without suction for use with Diatermo MB 240/250/300/380/400 with connecting cable 4 mm (30609)

30605

LAPAROSCOPIC ELECTRODES

code	LAPAROSCOPIC ELECTRODES
30605	L-Hook electrode - 36 cm
30606	J-Hook electrode - 36 cm
30607	Spatula electrode - 36 cm
30609	Monopolar cable - 4 mm - M - F

To generator

HIGH POWER ELECTROSURGICAL UNITS 300 AND 400 WATT



- 30634 DIATERMO MB 300D
- 30635 DIATERMO MB 400D

DIATERMO MB300D and MB400D are high frequency electro-surgical equipments suitable to deliver current for monopolar cut and coagulated cut (with different levels of coagulation), bipolar cut and coagulation.

TWIN OPERATIVE ACTIVITY

- two output channels for monopolar cutting
- two independent setting and output channels for the most frequent monopolar coagulation

CONTROLLED CUTTING PROCEDURES

- enhanced cutting current for eschar free incision
- cutting current with selectable coagulating property for bleeding controlled dissection
- low capacitive coupling by slow BLEND current for endoscopic procedures

TWIN CONTROLLED COAGULATION PROCEDURES

- SPEEDY coagulation and DEEP coagulation available to two operators
- SPRAY coagulation by hand switch or foot switch controls

EXTENSIVE BIPOLAR FEATURES

- bipolar cutting current with selectable bleeding control
- slow BLEND cutting current



TECHNICAL SPECIFICATIONS MB300/MB400

	MB 300	MB 400
Maximum out power monopolar pure CUT	300 W - 300 Ω	400 W - 300 Ω
Maximum out power monopolar cut-coag CUT80%	250 W - 300 Ω	350 W - 300 Ω
Maximum out power monopolar cut-coag CUT60%	200 W - 300 Ω	250 W - 300 Ω
Maximum out power monopolar cut-coag CUT40%	150 W - 300 Ω	200 W - 300 Ω
Maximum out power monopolar cut ENHANCED	200 W - 500 Ω	250 W - 500 Ω
Maximum out power monopolar cut-coag BLEND	200 W - 300 Ω	250 W - 300 Ω
Maximum out power monopolar coag SPEEDY	100 W - 500 Ω	120 W - 500 Ω
Maximum out power monopolar coag DEEP	100 W - 200 Ω	120 W - 200 Ω
Maximum out power monopolar coag SPRAY	70 W - 2000 Ω	100 W - 2000 Ω
Maximum out power monopolar coag SPRAY ARGON	70 W - 2000 Ω	100 W - 2000 Ω
Maximum out power bipolar CUT	95 W - 150 Ω	95 W - 150 Ω
Maximum out power bipolar cut-coag CUT80%	95 W - 150 Ω	95 W - 150 Ω
Maximum out power bipolar cut-coag CUT60%	95 W - 150 Ω	95 W - 150 Ω
Maximum out power bipolar cut-coag CUT40%	60 W - 150 Ω	60 W - 150 Ω
Maximum out power bipolar cut-coag BLEND	90 W - 150 Ω	90 W - 150 Ω
Maximum out power bipolar cut-coag BLEND	70 W - 100 Ω	70 W - 100 Ω
Working frequency monopolar / bipolar	425 kHz / 525 kHz	425 kHz / 525 kHz
Patient circuit	F	F
Selectable input voltage	115-230 Vac	115-230 Vac
Mains frequency	50-60 Hz	50-60 Hz
Electrical input voltage	1000 VA	1000 VA
Size WxHxD mm	470x150x400	470x150x400
Weight	17.5 Kgs	17.5 Kgs
Controls: Patient/Plate circuit monitoring, Output power monitoring, Self check control		
Safety: EN60601-1, EN60601-1-2, EN60601-2-2, Electrical Class: I CF, MDD 93/42/EC Class: II b		

- automatic Start/Stop coagulation functions

SURGEON AND PATIENT TOTAL SAFETY

- acceptability of contact impedance between patient body and return electrode continuously monitored by Skin Plate Electronic Control (SPEC)

- H.F. Leakage currents continuously monitored

- mains fluctuation automatically compensated before delivery of HF power

PERSONALIZED PROCEDURES

- independent choice of coagulation currents and power levels by each of two operators

- up to 10 procedures can be configured and re-called

EXTENSION DRIVER AND INTERLOCK SIGNALS

- driven output connection to external Argon Plasma unit and Smoke Evacuator unit

AUTOMATIC SELF DIAGNOSIS

- automatic diagnostic control of the complete functionality of electronic unit and connected accessories with coded report of failures

SUITABLE IN:
 OUTPATIENT SURGERY
 GENERAL SURGERY
 PAEDIATRIC SURGERY
 PLASTIC SURGERY
 THORAX SURGERY
 VASCULAR SURGERY
 DERMATOLOGY
 ENDOSCOPY
 GASTROENTEROLOGY
 GYNAECOLOGY
 NEUROSURGERY
 ORTHOPEDICS
 OTORHINOLARINGOLOGY
 PNEUMOLOGY
 UROLOGY
 VETERINARY

STANDARD ACCESSORIES

- 1 - Power supply cord 5 m
- 1 - Two-button autoclavable handle (30536)
- 5 - Two-button cold sterilizable handle (30551)
- 1 - Cable for flat plate (30559)
- 5 - Rem disposable ground pads (30493)
- 2 - HP double Water proof foot switch
- 3 - Short, general surgery blade electrode 7 cm
- 3 - Long, general surgery blade electrode 16 cm
- 3 - Short, general surgery ball electrode Ø 4 mm, 6 cm
- 1 - Electrode brush
- 1 - User manual (IT, GB)
- 1 - Service manual (IT, GB)



LOOP ELECTRODES Ø 2.4 mm



code	Reference number	LOOP ELECTRODES - Ø 2.4 mm autoclavable at 121° C	Shaft length	Electrode width	Electrode depth
30686	50	Square loop electrode	13 cm	10 mm	8 mm
30687	51	Loop electrode	13 cm	15 mm	8 mm
30688	52	Loop electrode	13 cm	20 mm	10 mm

ELECTRODES AND HANDLE Ø 4 mm



- 30480 AUTOCLAVABLE MB HANDLE Ø 4 mm - 100 times
Autoclavable handle up to 100 times for Ø 4 mm shaft electrodes with 3 m silicone cable and blade electrode.
 - 30482 NEEDLE ELECTRODE Ø 4 mm
 - 30483 BLADE ELECTRODE Ø 4 mm
 - 30484 BALL ELECTRODE Ø 4 mm
- S/S electrodes autoclavable 100 times. Sold in box of 5. Length 5.5 cm.

AUTOCLAVABLE ELECTRODES Ø 2.4 mm

code	Reference number	AUTOCLAVABLE ELECTRODES Ø 2.4 mm	Reference number	code
length 5 cm		minimum order: 6 pcs.	length 10 cm	
30501	1	Electrode wire 0.2 - straight	21	30521
30502	2	Electrode wire 0.2 - angled 45°	22	30522
30503	3	Electrode bend - Ø 4 - straight	23	30523
30504	4	Electrode bend - Ø 8 - straight	24	30524
30505	5	Electrode hook - angled 45°	25	30525
30506	6	Electrode wire 1 mm.- angled 45°	26	30526
30507	7	Electrode straight slip-knot - straight	27	30527
30508	8	Electrode angled slip-knot - straight	28	30528
30509	9	Electrode ball point - Ø 3 mm - angled 45°	29	30529
30510	10	Electrode ball point - Ø 3 mm - straight	30	30530
30500	SET	Set of 10 electrodes	SET	30531
length 7 cm		minimum order: 10 pcs.	length 15 cm	
30511	15	Needle electrode	35	30532
30512	16	Blade electrode	36	30533
30513	17	Ball electrode	37	30534

SINGLE USE STERILE ELECTRODES Ø 2.4 mm

code	Reference number	SINGLE USE ELECTRODES Ø 2.4 mm	Reference number	code
length 7 cm		Sterile electrode - box of 24	length 15 cm	
30670	13	Needle electrode - sterile electrode	33	30674
30671	11	Blade electrode - sterile	31	30675
30672	12	Ball Ø 4 mm electrode - sterile	32	30676
		Sterile electrode - box of 10	length 13 cm	
-	-	Loop electrode - 15 mm x 8 mm	34	30678

NON-STICK SINGLE USE STERILE ELECTRODES Ø 2.4 mm

code	NON-STICK SINGLE USE ELECTRODE Ø 2.4 mm	Length
30420	Blade electrode - sterile	7 cm
30422	Blade electrode - sterile	10 cm
30425	Needle electrode - sterile	10 cm
30429	Ball electrode - sterile	13 cm

BALLET STERILE DISPOSABLE ELECTROLYSIS NEEDLES



Ballet needles
The Ballet needle is manufactured with both a precise point and a mirror-like surface polish. The rounded tapered point of the needle will assist the electrologist in locating the follicle opening and upon insertion the needle will slide smoothly and accurately to the base of the follicle.

Stainless steel needles
Ideal for patients with strong healthy skin who respond well to electrolysis treatment.

Insulates needles
Suggested for patients with high sensitivity to discomforts of electrolysis.

24 carat gold plated needles
For clients who suffer from allergies and sensitive skin.

Stainless steel	Gold plated	Insulated	ELECTROLYSIS NEEDLES - STERILE	Minimum order
30400	30405	30410	K2 needle - 0.055 mm (0.002")	box of 50
30401	30406	30411	K3 needle - 0.075 mm (0.003")	box of 50

3-PIN MONOPOLAR HANDLES FOR ELECTRODES Ø 2.4 mm

VALLEYLAB CONNECTOR HANDLES with 2 "click" push-buttons GIMA autoclavable electrosurgery pencils with CUT-COAG switch have been studied and tested to offer maximum reliability and functionality to the operator. MB handles are provided with a 3 Pin plug Valleylab type fitting all Gima mono-bipolar Diatermo MB (120, 122, 132, 160, 200, 202, 240, 250, 380, 400) and most of bipolar electrosurgical units: Aspen Lab, ES Generator, EMC Statome, Danieli, Braun, Berchtold, Ohmeda, Ritter, Conmed, Eschmann, Bovie, Martin, Kontron, Bard, Birtcher 771, Cobi, Valleylab, Led, Erbe...

AUTOCLAVABLE HANDLES

- **30554 MB AUTOCLAVABLE HANDLE - 100 times**
Autoclavable handle with 2 large "click" push-buttons, provided with a 3 meter long silicone cable and a blade electrode. It can be autoclaved up to 100 times (electrode 20 times).
- **30545 MB AUTOCLAVABLE HANDLE - 100 times**
Same as code 30554 but with a 5 m long silicone cable
- **30550 PRIMA MB AUTOCLAVABLE HANDLE - 60 times**
Autoclavable handle with 2 large "click" push-button, provided with a 3 meter long silicone cable and a blade electrode. It can be autoclaved up to 60 times.
- **30548 STAR AUTOCLAVABLE HANDLE - 30 times**
Same as code 30554 but autoclavable up to 30 times (electrode is autoclavable up to 20 times).
- **30539 ORION PLUS AUTOCLAVABLE HANDLE - 100 times**
Same as 30554, but with a screw clamp locking system ensuring a safe contact and adapting to slightly different electrode diameters. High insulation to prevent liquid damage.
- **30536 SURGEON AUTOCLAVABLE HANDLE - 100 times**
Autoclavable, waterproof handle with ergonomic grip. Coloured ring that indicates CUT and COAG push buttons. Provided with 3 m cable and blade electrode.

SINGLE USE HANDLE

- **30551 KIRKY SINGLE-USE HANDLE - STERILE**
Single-use handle with "click" push-buttons for cut and coag. Includes blade electrode.
- **30553 GIMA SINGLE-USE HANDLE - STERILE**
Same as 30551 with 3 m cable.



1-PIN MONOPOLAR HANDLES FOR ELECTRODES Ø 2.4 mm

1 pin plug HANDLES for diatermo 50, 80, 106, 108

These handles are provided with a 1 Pin socket (4 mm) fitting all Gima Diatermo and most of electrosurgical units in the market. These handles **do not have push-buttons**.

- **30515 SURGEON 1 PIN AUTOCLAVABLE HANDLE - 100 times**
Autoclavable, waterproof handle with ergonomic grip. Provided with 3 m cable and blade electrode
- **30519 AUTOCLAVABLE 50-80-106-108 HANDLE**
Autoclavable handle without buttons, provided with a 3 meter long cable and a blade electrode. It can be autoclaved up to 50 times.
- **30518 KIRKY SINGLE-USE 50-80-106-108 HANDLE - STERILE**
Single-use handle without button with blade electrode with 4 mm PIN connection.



HANDLES FOR ELECTROLYSIS NEEDLES

Needle handles for all GIMA Diatermo and electro-depilators

- **30552 HANDLE** for electrolysis needles
- **30415 PROFESSIONAL HANDLE** for electrolysis needles
see electrolysis needles at page 187



ELECTRODE BRUSHES

- **30537 ELECTRODE BRUSH - 50x50 mm**
Disposable sterile radiopaque abrasive tip cleaner pad. Box of 100

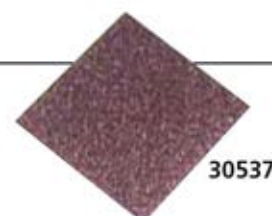



BIPOLAR CABLES FOR MAJOR BRANDS

Quality highly flexible silicone bipolar cables. Autoclavable at 134°C for minimum 20 times. 3 m long (10").

Recommended ETO sterilization for max extended life. Suitable for most generators, with connector for European or US forceps.

<p>Connector to forceps</p> <p>30642</p> <p>• 30642 BIPOLAR CABLE ADAPTOR</p>	<p>Connector to forceps</p> <p>30632</p>	<p>Connector to forceps</p> <p>30618</p>	<p>Connector to forceps</p> <p>30640</p>	<p>Connector to forceps</p> <p>30637</p>	<p>Connector to forceps</p> <p>30643</p>	<p>Connector to forceps</p> <p>30618+ 30642</p>	<p>Connector to forceps</p> <p>30617</p>	<p>Connector to forceps</p> <p>30644</p>	<p>Connector to forceps</p> <p>30639</p>	<p>Connector to forceps</p> <p>30638</p>
	<p>code</p> <p>30632</p>	<p>code</p> <p>30618</p>	<p>code</p> <p>30640</p>	<p>code</p> <p>30637</p>	<p>code</p> <p>30643</p>	<p>code</p> <p>30618+ 30642</p>	<p>code</p> <p>30617</p>	<p>code</p> <p>30644</p>	<p>code</p> <p>30639</p>	<p>code</p> <p>30638</p>
<p>Connector to forceps</p> <p>Compatibility brand/model</p>	<p>EU</p> <p>GIMA: MB 240, MB 380</p> <p>VALLEY LAB, CONMED, CODMAN, OLYMPUS</p>	<p>US</p> <p>GIMA: MB 120 F, MB 200 F, MB 200 D, MB 250, MB 300 D, MB 400 D</p> <p>LED: SURTRON 120, 200, 300, 400</p> <p>VALLEY LAB, EMC, DOLLEY</p>	<p>EU</p> <p>GIMA: MB 122, MB 160, MB 200, MB 202</p>	<p>EU</p> <p>GIMA: MB 122, MB 160, MB 200, MB 202</p>	<p>EU</p> <p>GIMA: MB 122, MB 160, MB 200, MB 202</p>	<p>EU</p> <p>GIMA: MB 80 D, MB 120 D, MB 160 D</p> <p>LED: SURTRON 80, 120, 160</p>	<p>EU</p> <p>MARTIN BERCHTOLD AEscULAP WOLF</p>	<p>EU</p> <p>ERBE SELECT DOWNS SIEMENS</p>	<p>EU</p> <p>ERBE SELECT DOWNS SIEMENS</p>	

SINGLE USE, METAL AND RUBBER PLATES

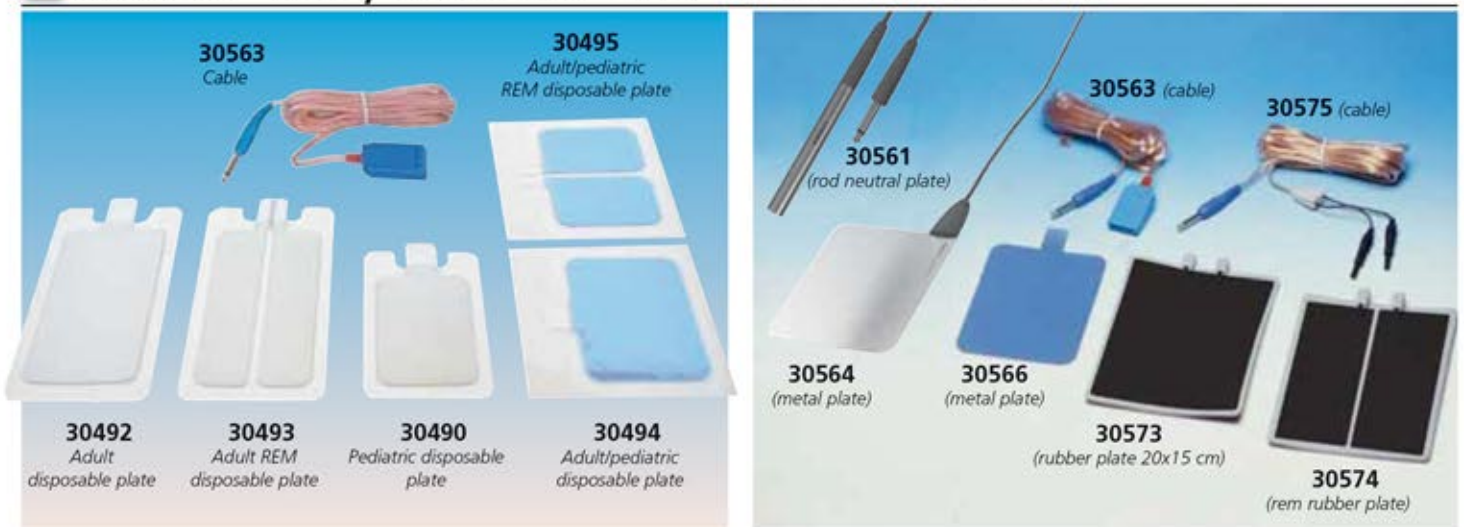

- 30492 DISPOSABLE GROUND PADS WITH SOLID GEL - adult
- 30490 DISPOSABLE GROUND PADS WITH SOLID GEL - pediatric
- 30493 REM DISPOSABLE GROUND PADS WITH SOLID GEL - adult
- 30494 DISPOSABLE NON WOVEN GROUND PADS - adult/ped
- 30495 REM DISPOSABLE NON WOVEN GROUND PADS - adult/ped
- 30563 CABLE FOR PLATES - 5 m
- 30559 CABLE FOR PLATES - 2.5 m

- 30573 RUBBER PLATE 20x15 cm - without cable
- 30574 REM RUBBER PLATE 20x15 cm - without cable
- 30575 CABLE FOR RUBBER PLATES
- 30566 METAL PLATE - without cable
- 30564 SURGEON NEUTRAL PLATE 16x12 cm - with cable
- 30561 ROD NEUTRAL PLATE with cable

3M ELECTROSURGICAL GROUNDING PADS WITH SAFETY RING

- 30496 3M 9160 SPLIT GROUNDING PAD - box of 100
 - 30497 3M 9160F SPLIT GROUNDING PAD - box of 200 (40 pouches of 5 pieces)
 - 30498 3M 9165 SPLIT GROUNDING PAD - pre-recorded - box of 40
- The 3M 9160, and 9165 Universal Grounding Pads all have a conductor area of 15 square inches and come with the patented 3M Green Safety Ring technology which allows them to perform the same as grounding pads that are up to 33% larger in conductor area. Green Ring allows adult and pediatric use.

In addition, they have fluid resistant, non-woven backing which allows heat to pass through up to 25% faster than foam, and they have no minimum age or weight limit.



30498
(3M 9165)

30496, 30497
(3M 9160)

UNIVERSAL HIGH QUALITY INSULATED BIPOLAR FORCEPS

EUROPEAN CONNECTOR BIPOLAR FORCEPS

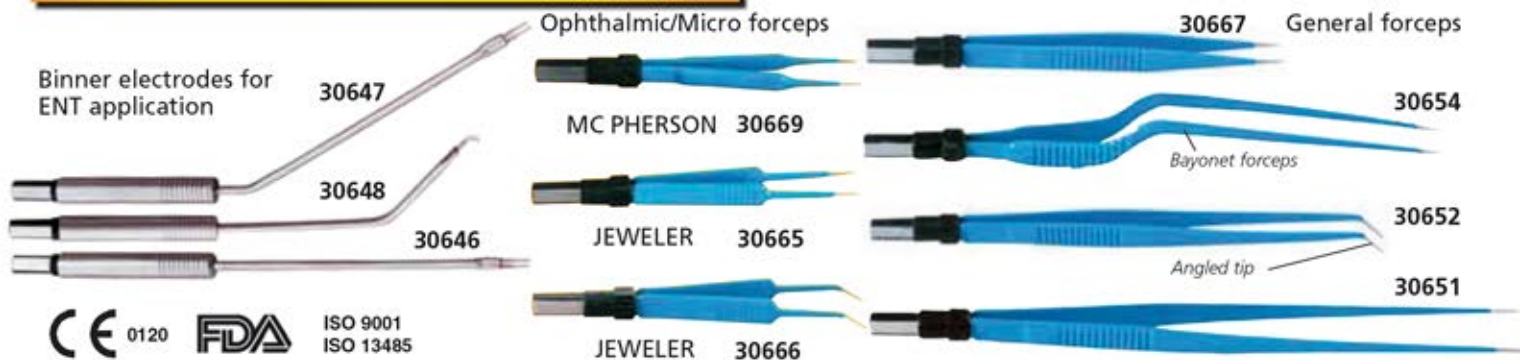

CE 0120 FDA ISO 9001 ISO 13485

code	Model	Connector	Length		Tip style	Application	Tip size
			cm	inches			
30645	BINNER	EU	22 cm	8½"	ANGLED	ENT	-
30646	BINNER	EU	18 cm	7"	STRAIGHT	ENT	-
30647	BINNER	EU	18 cm	7"	ANGLED	ENT	-
30648	BINNER	EU	19 cm	7¾"	ANGLED 45°	ENT	-
30650	STRAIGHT	EU	18 cm	7"	STRAIGHT	GENERAL	1 mm round points
30656	STRAIGHT with irrigation	EU	18 cm	7"	STRAIGHT	GENERAL	1 mm round points
30651	STRAIGHT	EU	20 cm	7¾"	STRAIGHT	GENERAL	1 mm round points
30658	STRAIGHT	EU	20 cm	7¾"	STRAIGHT	GENERAL	2 mm round points
30652	STRAIGHT	EU	18 cm	7"	ANGLED	GENERAL	1 mm round points
30653	STRAIGHT	EU	20 cm	7¾"	ANGLED	GENERAL	1 mm round points
30657	BAYONET	EU	16.5 cm	6½"	STRAIGHT	GENERAL	1 mm round points
30654	BAYONET	EU	18 cm	7"	STRAIGHT	GENERAL	1 mm round points
30655	BAYONET	EU	20 cm	7¾"	STRAIGHT	GENERAL	1 mm round points
30659	BAYONET	EU	22 cm	8¾"	STRAIGHT	GENERAL	1 mm round points
30663	BAYONET	EU	24 cm	9½"	STRAIGHT	GENERAL	1 mm round points
30660	STRAIGHT	EU	18 cm	7"	ANGLED	GENERAL	0.3 mm points
30661	STRAIGHT	EU	18 cm	7"	STRAIGHT	GENERAL	0.3 mm points
30662	STRAIGHT	EU	20 cm	7¾"	STRAIGHT	GENERAL	0.3 mm points
30664	ADSON	EU	12.1 cm	6"	STRAIGHT	GENERAL	1 mm round points
30665	JEWELER 5	EU	11.5 cm	4½"	STRAIGHT	OPHTHALMIC/MICRO	0.25 mm points
30666	JEWELER 5	EU	11.5 cm	4½"	ANGLED	OPHTHALMIC/MICRO	0.25 mm points
30667	STRAIGHT	EU	15 cm	6"	STRAIGHT	OPHTHALMIC/MICRO	0.5 mm points
30668	STRAIGHT	EU	15 cm	6"	ANGLED	OPHTHALMIC/MICRO	0.5 mm points
30669	Mc PHERSON	EU	10.2 cm	4"	STRAIGHT	OPHTHALMIC/MICRO	0.5 mm points

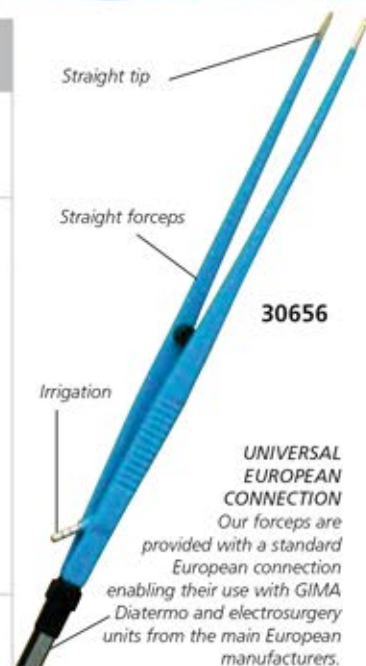

US CONNECTOR BIPOLAR FORCEPS

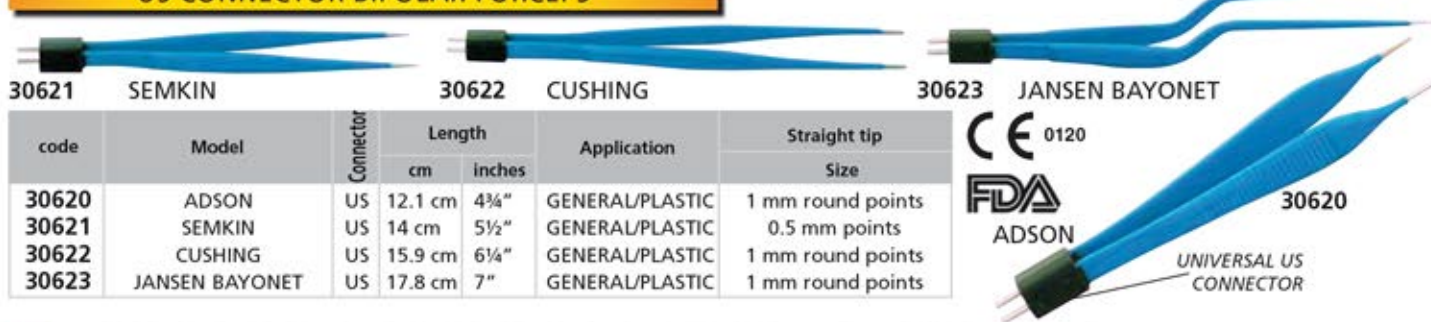

code	Model	Connector	Length		Application	Straight tip Size
			cm	inches		
30620	ADSON	US	12.1 cm	4¾"	GENERAL/PLASTIC	1 mm round points
30621	SEMKIN	US	14 cm	5½"	GENERAL/PLASTIC	0.5 mm points
30622	CUSHING	US	15.9 cm	6¼"	GENERAL/PLASTIC	1 mm round points
30623	JANSEN BAYONET	US	17.8 cm	7"	GENERAL/PLASTIC	1 mm round points

CE 0120 FDA ADSON

UNIVERSAL US CONNECTOR

EUROPEAN NON-STICK BIPOLAR FORCEPS

NON-STICK BIPOLAR FORCEPS

Thanks to new Ag-Tech non-stick technology, the forceps stay clean, virtually eliminating the need for cleaning during

coagulation. A tip material with excellent thermal properties prevents the sticking of tissues. The non-stick effect is permanent and will not reduce with the use of forceps.

code	Model	Connector	Length		Tip style	Tip size
			cm	inches		
30460	STRAIGHT	EU	15	6"	STRAIGHT	1 mm
30461	STRAIGHT	EU	18	7"	STRAIGHT	1 mm
30462	STRAIGHT	EU	20	7¾"	STRAIGHT	1 mm
30464	STRAIGHT	EU	18	7"	ANGLED	1 mm
30465	STRAIGHT	EU	20	7¾"	ANGLED	1 mm
30468	BAYONET	EU	18	7"	STRAIGHT	1 mm
30469	BAYONET	EU	20	7¾"	STRAIGHT	1 mm
30472	JEWELER	EU	11.5	4.5"	STRAIGHT	0.7 mm
30473	JEWELER	EU	11.5	4.5"	ANGLED	0.7 mm
30474	ADSON	EU	12.1	4¾"	STRAIGHT	1 mm

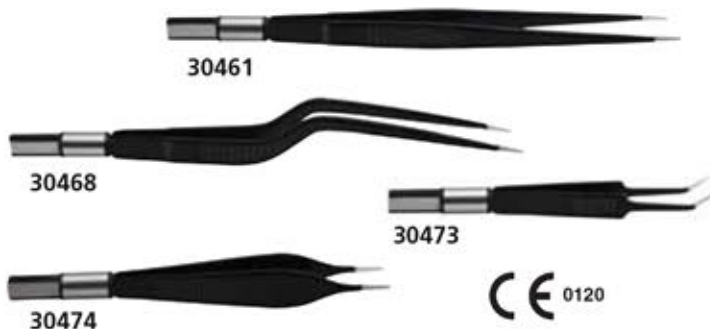

FOOTSWITCHES AND BOARDS

code	FOOTSWITCHES FOR 50, 80, 106, MB 120, 122, 132, 160, 200, 202
30577	Waterproof MB footswitch - 2m cable
30578	Waterproof MB footswitch - 3m cable
ANTIEXPLOSION FOOTSWITCH FOR MB 120, 122, 132, 160, 200, 202	
30602	Double antiexplosion, water proof MB footswitch
ANTIEXPLOSION FOOTSWITCHES FOR MB 240, 250, 300D, 380, 400, 400D	
30603	Double antiexplosion, water proof footswitch - MB240-380
30604	Double antiexplosion, water proof footswitch - MB250-400-300D-400D
MAIN BOARD	
30557	Main board - specify model and serial number of diatermo with order
30558	Output board for MB 240, 250, 380, 400 - specify as above



30602-3-4
It allows selection from pedal of CUT and COAG functions
Antiexplosion and waterproof.

MONOPOLAR FORCEPS, SCISSORS AND CABLES

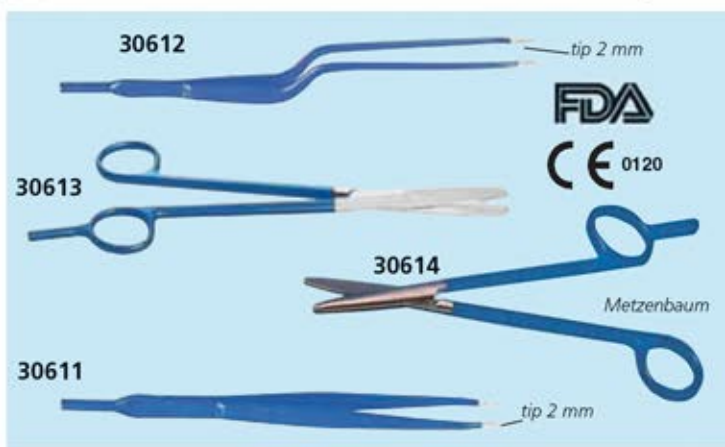

Monopolar forceps and scissors are provided with a 4 mm connection for standard monopolar cables. These can be used with all Gima, LED, Erbe and many other electrosurgical units in the market.

code	INSULATED MONOPOLAR INSTRUMENTS
30610	Monopolar cable - 4 mm pin
30611	Mc INDOE straight monopolar forceps 15 cm (6")
30612	Bayonet monopolar forceps - 20 cm (7 1/2")
30613	Monopolar scissors - straight - 18 cm (7")
30614	Metzenbaum monopolar scissors - straight - 18 cm (7")
30615	Metzenbaum monopolar scissors - curved - 18 cm (7")

ELECTROSURGERY SMOKE EVACUATOR

• 30450 SMOKE EVACUATOR

An aspiration and filtering system for the smokes produced during the surgical procedures. The smokes, generated during the surgical procedures, have a bad, strong and persistent smell. These smokes consist of water vapour, organic gas, visible or invisible solid particles and viral parts. So a good aspiration and filtration eliminates bad smells, reduce the bacteriological and/or viral risks, and improves vision of the zone of the operation area during the laparoscopic procedures.

Activation of the aspiration can be:

- **Automatic**, through the remote electronic system of automatic survey of the activation of the high frequency electrosurgical unit
- **Manual**
- **Through a foot switch (optional)**

The aspiration flow can be adjusted to suit the specific needs. For laparoscopic procedures there is a specific function L,

quickly selectable. Smoke evacuator has an electronic control of the aspiration with the indication of the wearing status of the filters. There are two different kinds of quickly replaceable ULPA type filters, with active carbons: the BLUE filter is the first filter and it is included with the unit for an initial time of use (5 hours), the RED filter is an optional spare part, developed for a long time use (20 hours).

They have connector of 7/8".

- 30452 ULPA FILTER (20 hours) RED - spare
- 30453 ASPIRATION KIT - box of 6
- 30454 HANDLE ASPIRATION KIT - sterile - box of 12
- 30577 WATERPROOF MB FOOTSWITCH - 2 m

TECHNICAL SPECIFICATIONS

Mains voltage	230 V (115 V on request)
Mains frequency	50/60 Hz
Electrical input power	800 VA
Max vacuum flow rate	1000 LPM (35 CFM)
Max static suction	250 mbar (83 in H ₂ O)
Filter type	ULPA with active carbons
Filter efficiency	99,999%
Particles diameter	0.12 micron
Size	370x144x319 mm
Weight	4 kg

STANDARD ACCESSORIES

- ULPA filter (5 hours) blue
- Aspiration kit (A) filter + (B) pipe Ø 22 mm, length 2.4 m
- 4 handle aspiration kit (C) adapter 10 mm / 22 mm (D), pipe Ø 10 mm, length 1.8 m, (E) clip to fix the pipe to the handle, (F) adapter to the handle)
- Power cable



CHANGE-A-TIP™ CAUTERIES WITH HIGH TEMPERATURES

BOVIE CAUTERIES

- interchangeable sterile tips
- replaceable batteries
- reusable handles
- no sterilization necessary



30590
(Fine tip, not sterile, included)

code	INTERCHANGEABLE TIP CAUTERIES MINIMUM ORDER: 10 TIPS	Recommended for:
30590	Cautery handle "AA" (tip included)	All tips
30593	High temp loop tip - sterile	DER/ENT
30594	High temp 2" flex loop tip - sterile	GYN/ENT
30595	High temp 5" loop tip - long size - sterile	GYNAECOLOGY
30596	High temp fine tip - sterile	DER/CARDIO
30597	High temp elongated tip - sterile	VASECTOMY

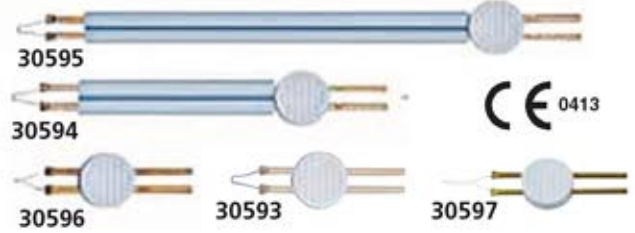

REUSABLE HIGH TEMPERATURE CAUTERY WITH REPLACEABLE TIP

CAUTERIES - 1,200°C (2,200°F) - made in Italy

- interchangeable tips with nickel-chrome wire
- replaceable batteries
- reusable handles

Wide application in gynaecology, orthopedy, ear/nose/throat, dermatology, plastic and reconstruction surgery.

code	INTERCHANGEABLE TIP CAUTERIES MINIMUM ORDER: 10 TIPS
30598	Cautery handle "AA" (tip not included)
30599	High temp long fine tip - sterile - box of 10
30600	High temp large tip - sterile - box of 10
30601	High temp fine tip - sterile - box of 10

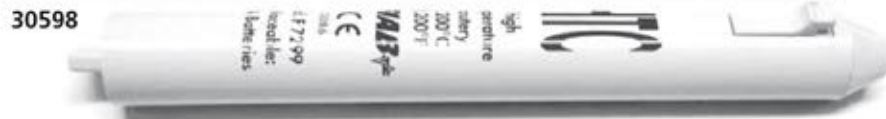

30601
CE 0086

HIGH TEMPERATURE ELECTROCAUTERIES

• 30580 ELECTROCAUTERY - 1,200 °C - fine tip - made in Italy

Electrocautery is a sterile bipolar battery operated disposable device for the cauterization of small vessels; the temperature of the tip is 1,200°C. With a fine tip required in most of the surgeries.

• 30582 GYNAECOLOGY CAUTERY - 1,200°C - fine tip

Same as 30580 but with the tip fixed on a 12 cm long shaft.

• 30581 ELECTROCAUTERY - 600 °C - fine tip

Same as 30580 but with lower temperature = 600°C. Especially designed for ophthalmology.

• 30583 EMERGENCY ELECTROCAUTERY - 800°C - Thick tip

Same as 30580 but with "thick tip" for the perforation of nails in case of haematoma.

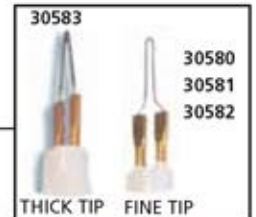

CARTS FOR ELECTROSURGICAL UNITS

Trolley designed to hold and carry electrosurgical units (including Argon units). Ergonomics has been particularly considered for the design, for example the height of 900mm with inclined top shelf allows easy reading of the unit's display.

The trolley is provided with a second shelf with antiskid raised edges, two drawers placed at the base and a rear space with securing straps to hold two Argon cylinders. The upright stands holding the shelves are designed to take possible optional accessories. All parts of the trolley are made of epoxy-painted, tempered steel and aluminum.

Available version with 4 socket group, fuses box, independent grounding plug, power cable 3m.

TECHNICAL SPECIFICATIONS	
Load capacity:	- Total load 200 kg - Inclined shelf 50 kg
Inclined shelf:	42x45 cm (27864/6) 50x50 cm (27865/7)
Drawers and shelf:	42x31 cm (27864/6) 50x36 cm (27865/7)

code	CARTS FOR ELECTROSURGICAL UNITS
27864	DIATERMO CART - medium
27865	DIATERMO CART - large
27866	DIATERMO CART with power - medium
27867	DIATERMO CART with power - large



HISTOFREEZER® CRYOSURGICAL SYSTEM

- **30591 HISTOFREEZER®** - kit with applicator 2 mm
Two 80 ml aerosol bottles and 60 applicators 2 mm.
- **30592 HISTOFREEZER®** - kit with applicator 5 mm
Two 80 ml aerosol bottles and 52 applicators 5 mm.
- **30589 HISTOFREEZER®** - large kit mixed applicators
Two 80 ml aerosol bottles, 24 applicators 2 mm, 36 applicators 5 mm.
- **30585 HISTOFREEZER®** - mini kit mixed applicators
One 80 ml aerosol bottle, 16 applicators 2 mm, 16 applicators 5 mm.

The Histofreezer® portable cryosurgical system is a low cost, highly effective cryosurgical agent that provides safe and effective treatment for warts and other common benign skin lesions.

This therapeutic treatment makes use of local freezing for the controlled destruction or removal of living tissue.

Suitable for adults and children

Effective use on 9 benign lesion types

	% of resolution*
- Verruca Vulgaris (Common Warts)	94%
- Verruca Plantaris (Plantar Warts)	86%
- Molluscum Contagiosum	100%
- Lentigo (Age Spots)	100% - facial 99% - non facial
- Condyloma (Genital Warts)	89%
- Seborrheic Keratosis	95%
- Acrochordon (Skin Tags)	100%
- Verruca Plana (Flat Warts)	93%
- Actinic keratosis (Facial and Non-Facial)	91% - facial 87% - non facial

*Summary of resolution rates by type of lesion from a number of clinical trials obtained with histofreezer + post-treatment of 27% salicylic acid / 17% lactic acid
Supplied with box and manual in: GB, FR, IT, DE, ES, NL, PL.
From web you can download: GR, PT, TH, Arab.

Saturated 2 mm applicators will stay cold for 90 seconds.



Saturated 5 mm applicators will stay cold for 120 seconds.



2 mm disposable applicator for small lesions
5 mm disposable applicator for large lesions



CHARGE
custom applicator press valve until droplets start to form.



INVERT
canister for 15 seconds for optimal freezing temperature.



APPLY
a frozen applicator to lesion for 15-40 seconds.

BIOLOGICAL MICROSCOPES - MAGNIFICATION 40X-1600X

- **31002 LED BIOLOGICAL MICROSCOPE - 40X to 1600X**
High level microscope with high resolution and transmission
Main features:
- infinite optical system
- wide field eyepiece WF 10X/20
- infinite semi-plan achromatic objectives 4X, 10X, 40X, 100X
- Abbe condenser
- backward quadruple nosepiece
- double layers mechanical stage (size: 150x139 mm, move range 75x52 mm)
- adjustable brightness
- power supply: switchable 110-220 V, 50 Hz

- **31000 BIOLOGICAL MICROSCOPE - 40X to 1000X**
- 30° compensation free binocular head
- eyepiece 10X (Field 18 mm)
- achromatic objectives 4X, 10X, 40X(S), 100X (S, oil)
- semi plan achromatic objective 40X, 100X, 400X, 1000X,
- interpupillary distance adjustment: from 55 to 75 mm
- mechanical stage, double layers (size: 125x135 mm, move range: 75x35 mm)
- Abbe condenser with iris diaphragm and filter
- halogen lamp 6 V, 20 W - brightness adjustment
- power supply: switchable 110-220 V, 50 Hz
• **31005 SPARE BULB for 31000**



UNIVERSAL CAMERA FOR MICROSCOPES
see code 32185 page 194

GERMAN FLEXIBLE NOSEPHARYNGOSCOPE

• 71602 FLEXIBLE NOSEPHARYNGOSCOPE with cable

The high precision multi-lens optics creates an optimal image. The thin insertion tubes are exceptionally maneuverable and have a special wide angle lens whereby a precise tip control and a remarkable depth of focus are reached.

Exacting workmanship and high quality materials create absolutely homogeneous illumination.

The handpiece is ergonomically formed and the insertion tube is especially comfortable for the patient.

This naso-pharyngoscope, with its proven design, is guaranteed to bring years of trouble-free service.

- wide angle, multi-lens objectives for excellent image quality
- excellent ergonomics allows one hand operation
- suitable for mechanical cleaning and disinfection



Supplied in lightweight aluminium rigid case with fibre optic cable, leakage tester and user manual (GB, IT)

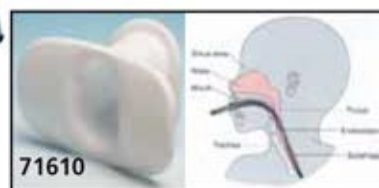

• 71610 ENDOSCOPY MOUTHPIECE - bag of 20 pcs Disposable bite blocks

TECHNICAL SPECIFICATIONS 71602

Resolution: 7,000 pixels	Working length: 300 mm
Working Ø: 3.2 mm	Tip deflection: up 140°, down 140°
Length of tip deflection: 20 mm	Depth of focus: 6 - 1,000 mm
Direction of view: 0°	Field of view: 70°
Weight: 260 g	Made in Germany

OTOSCOPES

ACMI / WOLF / STORZ / OLYMPUS fitting

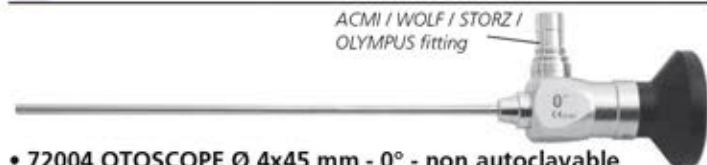

- 72004 OTOSCOPE Ø 4x45 mm - 0° - non autoclavable
- 72007 OTOSCOPE Ø 2.7x107.5 mm - 0° - non autoclavable
- 72008 OTOSCOPE Ø 2.7x107.5 mm - 30° - non autoclavable

SINUSCOPES

ACMI / WOLF / STORZ / OLYMPUS fitting



- 72010 SINUSCOPE Ø 4x175 mm - 0° - non autoclavable
- 72011 SINUSCOPE Ø 4x175 mm - 30° - non autoclavable
- 72012 SINUSCOPE Ø 4x175 mm - 70° - non autoclavable
- 72013 SINUSCOPE Ø 4x175 mm - 45° - non autoclavable

LARYNGOSCOPE

ACMI / WOLF / STORZ / OLYMPUS fitting



- 72021 LARYNGOSCOPE Ø 8x170 mm - 70° - non autoclavable

LIGHT SOURCE HANDLE

Connection to any endoscope with Storz fitting



- 30795 FLYER HALOGEN HANDLE 2.5 V - light source for endoscopes
 - 31478 BULB for 30795
 - 30794 FLYER LED HANDLE 2.5 V - light source
- Powerful handheld light source for endoscopes. 60,000 lux. Both flyer handles need 2xAAA batteries.

Wi-Fi/USB CAMERA FOR ENDOSCOPES AND MICROSCOPES

- 32185 MICFIEYE - Wi-Fi/USB CAMERA (C-mount)
- 32186 C-MOUNT F18 ADAPTER FOR ENDOSCOPES
- 32187 MICROSCOPE ADAPTER Ø 23 mm

MICFIEYE is a Wi-Fi camera with C-mount and allows to digitalize the image on tablets, smartphones and PC using dedicated Apps and Softwares. MICFIEYE needs an adapter



Each camera is supplied with USB cable (1.2 m), USB AC adapter, user manual (GB, IT, FR, ES, DE), software can be downloaded free of charge from web

to be compatible with all optical devices such as microscopes, endoscopes, boroscopes, fiberscopes, C-mount lenses etc.

TECHNICAL SPECIFICATIONS

Camera Type:	Colour CMOS camera
Sensor:	¼ Imax CMOS
Resolution:	1.3 MP
Image pixel:	320x240, 640x480, 1280x1024
Lens standard:	C-CS mount CCTV lens
Automatic optical features:	Gamma correction, exposure, white balance, black reference, flicker avoidance, defect identification, colour saturation
Button snapshot:	yes for Wi-Fi and USB mode
Dimension:	Ø 36x75 mm
Wi-Fi transmission distance:	≥ 5 m
Video resolution:	1.3 MP, 320x240, 640x480, 1280x1024
Frequency range:	2,400-24,835 GHz
Li-Ion battery:	Continuous working time - approx 2.5 hours
Power source:	5 V / 1A or USB (use only USB wall adaptors certified according to the CE and/or FCC regulations)
OS support:	iOS / Android / Windows / Mac
Software features:	USB and Wi-Fi MIC-fi: snapshot, video recording, calibration and measurement. Take time lapsed picture, (only USB Micfieye)

150 W HALOGEN LIGHT SOURCE



30801

• 30801 GIMA HALOGEN LIGHT SOURCE 150 Watt

Compact, lightweight, powerful light source for endoscopic use. A low noise fan positioned behind the halogen bulb provides the necessary cooling inside the metallic structure of the light source. A variable-intensity regulator enables selection 50 to 150 W. User manual in GB, ES, FR, IT, GR, PT.

code	CONNECTORS FOR GIMA LIGHT SOURCE TO DIFFERENT CABLES	TECHNICAL SPECIFICATIONS
30810	STORZ cable connector	Input for GIMA, SCHOLLY and LUT cables Dimension: 21x20x h 11 cm Max power absorption: 170 Watt Two protection fuses: 1.6 A.T. Power supply: 230V-50 Hz Norms: IEC 601-1 - 93/42/EEC (Class: I - Type: BF) Made in Italy: GIMA S.p.a.
30811	WOLF cable connector	
30812	OLYMPUS cable connector	
30815	PENTAX cable connector	
30816	FUJINON cable connector	
30808	Spare lamp 150W	

LED LIGHT SOURCE

• 27544 LED LIGHT SOURCE

Cold white light (5,500 °K, 200 lumen) for endoscopy use. It can be connected to endoscopes without need of F.O. cable. Handle connect directly to rigid endoscopes (Storz connection).

LCD display: 12.8x6.4 cm



27544

F. O. HEAD LIGHTS



30854

- 30850 WIDA FIBRE OPTIC HEAD LIGHT
 - 30854 WIDA PLUS FIBRE OPTIC HEAD LIGHT
- fibre optic cable complete with head light system**
 WIDA illumination systems are available in two versions: one with simple headband and standard illumination head, the other with professional headband, easily adjustable, and thin head. Both include F.O. cable with adaptor (30830) for connection to GIMA light source (30801).

Here below are available connectors to other light sources. Light beam can be focused through a focusing ring.

- 30852 FOCUS DEVICE for 30850 (since lot 14 - may 2012)
- It reduces light in a very luminous spot Ø 10 mm.

Diameter focus:

DISTANCE	30850	30854
20 cm	7-15 cm	6-10 cm
30 cm	10-22 cm	9-15 cm
50 cm	16-35 cm	14-20 cm

An exceptionally bright headlight with an illumination head for coaxial, shadow-free illumination of the viewing area.



30850

SURGICAL FIBRE OPTIC LIGHT CABLES AND ADAPTORS



1 LIGHT SOURCE ADAPTORS to connect GIMA F.O. cables to light sources

- 30830 GIMA light source adaptor
- 30831 STORZ - AESCULAP-MARTIN light source adaptor
- 30832 WOLF - HENKE SASS - DYONICS - MEDICON - COMEG light source adaptor
- 30833 OLYMPUS light source ad.
- 30834 ACMI light source adaptor
- 30835 HEINE light source adaptor
- 30836 FUJINON light source adaptor
- 30837 PENTAX light source adaptor

2 ENDOSCOPE ADAPTORS - on the cables to connect endoscopes to GIMA F.O. cables

- 30840 ENDO STORZ adaptor
- 30841 ENDO WOLF adaptor
- 30842 ENDO ACM, OLYMPUS-STRYKER adaptor

- 30817 FIBRE OPTIC CABLE 3.5 x 1,800 mm
- 30818 FIBRE OPTIC CABLE 4.8 x 1,800 mm
- 30822 FIBRE OPTIC CABLE 3.5 x 2,300 mm
- 30823 FIBRE OPTIC CABLE 4.8 x 2,300 mm
- 30826 FIBRE OPTIC CABLE 4.8 x 3,000 mm

High transmission surgical light cables, armoured but highly flexible with unique features:

- no burn outs
- strain relieved and protected by **silicone hose**
- **steam autoclavable** with warranty (12 months)
- light source end temperature resistant up to 300°C
- kink resistant
- no electrical interferences with endoscopic surgery units
- surgical stainless steel end fittings resist wear and corrosion
- stainless steel adaptors enables our cables to be used with other manufacturers halogen light sources/instruments

• 29975 FIBRE OPTIC CLAMP

- 29975 FIBRE OPTIC CLAMP
- 30840 ENDO STORZ adaptor
- 30841 ENDO WOLF adaptor
- 30842 ENDO ACM, OLYMPUS-STRYKER adaptor



GIMA ENT HEAD MIRRORS FOR BATTERY OR AC/DC TRANSFORMER USE

HEAD MIRRORS WITH TRANSFORMER

Simple adjustment of the band using rotating knob to fit any head size

Comfortable, padded head band easy to remove for cleaning

Supplied with plug-in transformer for direct power

Storz type head mirror

Silver coated mirror produces extremely bright light

Simple adjustment of the band using rotating knob

31110

31111

Head mirror Lux-100 with plug in transformer

HEAD MIRRORS WITH BATTERY

Comfortable, padded head band easy to remove for cleaning

On/off switch on battery

Supplied with head band mounted CR-123A battery box for 2x3 V batteries (not included)

Extension cable

Clar type head mirror

Silver coated mirror produces extremely bright light

31109

31108

LUX-100 AVAILABLE WITH LED LIGHT

Quality head mirrors Ø 55 or 100 mm to perfectly illuminate the examination area in every situation. Long life 6 V lamp provides bright and natural light, quality silver coated mirror allows optimum light reflection. Mirror and light beam can be easily and precisely adjusted.

STANDARD ACCESSORIES	LUX AC/DC TRANSFORMER 31110-31111	LUX BATTERY* 31107-31109 31112
Mirror with head band	•	•
Long life bulb	•	•
Head band mounted battery case** for 2 x 3V CR-123A	•	•
Plug in transformer* 100/240 V - 50/60 Hz with cable	•	•
Pocket battery case	•	•
Sturdy plastic case	•	•
Cordura bag	•	•
Extension cable 80 cm and on/off switch 30 cm cable	•	•

*Supplied with interchangeable UK, US, EU plugs **Battery not included

code	LUX ENT MIRRORS
31108	LUX-55 battery** head mirror - Ø 55 mm - 6 V
31112	LUX-55 battery*** head mirror - Ø 55 mm - 6 V
31109	LUX-100 battery** head mirror - Ø 100 mm - 6 V
31107	LUX-100 battery** LED head mirror - Ø 100 mm - 6 V
31110	LUX-55 AC/DC transformer head mirror - Ø 55 mm - 6 V
31111	LUX-100 AC/DC transformer head mirror - Ø 100 mm - 6 V
31114	Mirror for LUX-55 - spare
31115	Mirror for LUX-100 - spare
31116	Bulb for LUX mirrors - spare
31119	Carrying bag for LUX mirrors - black
31117	Battery case for LUX mirror 31112/3 - spare
31124	Connecting cable 30 cm for 31107-9 - spare
31118	Plug in transformer* 100-220 V - 50/60 Hz with cable - spare for 31100-1 - optional for 31107-9

*Supplied with interchangeable UK, US, EU plugs **Battery mounted on head mirror band
***Pocket battery case connected to head mirror

HEAD LOUPE AND MAGNIFYING GLASSES

CE

• 31170 HEAD LOUPE two magnifying systems (2.2X and 3.3X)

The system is mounted on an adjustable webbing head band and provided with two separate lenses. The first lens provides a 2.2X magnification, moving down the second lens, we reach a total 3.3X magnification. The superior quality of this lens permits high precision examinations. It can be used in combination with any kind of glasses. Working distance: 17 cm with 2.2X lens, 9 cm with 3.3 lens. Made in Japan.

Visual field 8.5x3 cm

31170



• 30861 DANAE MAGNIFYING GLASSES

Light, only 83 g

Adjustable 0-4.5 cm

Compatible with TETi protective shield (see page 16, 198)

- optical system with 3 magnifying glasses (2X, 2.5X, 3X)
- can fit over your glasses
- adjustable to any face shape

• 30848 SMART MAGNIFYING GLASSES

Spectacle frame with magnifying glasses useful to physician whenever it is necessary to have a magnified view of the visual field and be able to use both hands. Lightweight, it folds up, and can be worn over spectacles. 2.5X zoom lens which can be tilted to achieve optimum focus.

30848



ZIEGLER MIRROR

CE

• 31142 ZIEGLER MIRROR - Ø 90 mm

Concave back-silvered mirror, 90 mm diameter with 13 mm diameter hole, on adjustable band. Special mount permits replacement of glass mirror in event of breakage. Made in Germany.



1 W LED HEADLIGHTS

• 30858 LED HEADLIGHT

Run time: High mode: 3 hours - Low mode: 22 hours
Luminous intensity: 120 lumens (high) or 30 lumens (low)
30 feet drop test, super bright CREE cool white LED
MCU control push switch (High/Low/Off) 60° pivoting head.
Passed extreme temperature shock test, IPX4 water resistant
10,000 switch cycle life
Lighting leakage design when forget to turn off switch. 3AAA batteries included.

• 32200 "AAA" ALKALINE BATTERIES - blister of 4 pcs - spare

Compact and lightweight headlight only 65 g



HEINE LED HEAD LIGHT

POWERFUL LED ILLUMINATION

50,000 LUX at 250 mm

5 YEARS WARRANTY



30884

- **30884 HEINE ML4 LED^{HQ} HEAD LIGHT - J.008.31.413**
- LED in HQ: defining optimal light intensity (50,000 lux at 250 mm), brightness and homogeneity from edge to edge, and colour rendering (4,500 k, CRI >90, R9 > 75). This ensures true colour tissue for the most accurate diagnosis.
- Coaxial illumination: ensures a completely shadow-free image and allows for excellent illumination of difficult to see areas.
- Lithium Battery: for up to 8.5 hours of continuous working.
- LED Thermal Management: guarantees consistent quality and performance throughout the LED's lifetime (50,000 hours).
- Adjustable illumination spot size: 30 to 80 mm spot size range (at 420 mm working distance) to fit any examination situation.
- Comfortable and secure fit: multiple adjustment points and soft padding for comfort and stability even during long procedures.
- Illumination Intensity Control: for precise brightness setting
- Rechargeable battery pack and direct mains transformer included.
- **30883 HEINE ML4 LED^{HQ} HEAD LIGHT with DV1 DIGITAL VIDEOCAMERA and mPack[®] UNPLUGGED - J.008.31.470**
- Same as above with high resolution digital videocamera 1.3 megapixel
- **30886 HEINE BINOCULAR LOUPE 2.5X-340 mm - J.000.31.370**
- **30887 HEINE BINOCULAR LOUPE 2.5X-420 mm - J.000.31.371**
- **30888 P2 POLARIZATION FILTER FOR ML4 AND 2.5X LOUPES - J.000.31.326**

TECHNICAL SPECIFICATIONS

Power supply: mPack[®] Rechargeable Battery Pack with Li-ion battery and direct mains transformer
 Illumination: 50,000 lux at a working distance of 250 mm
 LED operating life: 50,000 hours
 Spot adjustment: 30 mm to 80 mm illuminated field diameter (at 420 mm)
 Colour temperature: 4,500°K Made in Germany

HEINE BINOCULAR LOUPES

Only 42 g

30930
30931

Eyepieces individually adjustable

2.5 X loupes



Set content: optics, S-frame with i-View loupe mount, detachable protective lenses, 2 sterilizable swivel levers, retaining cord, cleaning fluid, carrying case.

HEINE[®] S-FRAME[®] WITH BINOCULAR LOUPES

- Achromatic optics: crisp, bright image with colour-correction.
- Multi-coated, scratch-resistant silica glass lenses - produce crisp, clear images. High magnification with a large field of view and excellent depth of field.
- Water resistant
- Flexibility for precise adjustment: independently adjustable Pupillary Distance controls ensure precise alignment of the optics, for a stereoscopic view.
- i-View loupe mount; provides any angle of view and the possibility flips up and down the optics to exclude or re-include the magnification during any procedure.
- Different magnification and working distance.

code	BINOCULAR LOUPES	Magnification	Working distance	HEINE code
30930	Heine binocular loupes	2.5X	340 mm	C-000.32.355
30931	Heine binocular loupes	2.5X	420 mm	C-000.32.356
30932	Heine binocular loupes	4X	340 mm	C-000.32.431

- **30888 P2 POLARIZATION FILTER FOR ML4 AND 2.5X LOUPES - J.000.31.326**
- **30935 HEINE LED LOUPELIGHT with mPack[®] LL and plug-in transformer - C-008.32.264**

HEINE LED in HQ (50,000 lux at 250 mm, 4,500 k, CRI>90, R9 > 75) provides the best coaxial, intense, accurate and homogeneous LED illumination. 17 hours continuous ON time at full power with mPack LL. LED Thermal Management ensures consistent quality and performance of the illumination throughout the LED's lifetime rating of up to 50,000 hours.

30935
For use with S-frame binocular loupes

IUKO VISION MODULAR SYSTEM

GALILEAN TELESCOPES

- **30864 CALLIOPE - Galilean telescope 3X - dental (working distance 35 cm)**
- **30865 CALLIOPE - Galilean telescope 3X - surgical (working distance 45 cm)**
- **30866 CALLIOPE - Personalized Galilean telescope: magnification from 2X to 3X, working distance from 28 to 60 cm - specify with order**



CALLIOPE
30864/5/6

- magnifying optical system with Galilean telescopes
- waterproof telescope
- compatible with TETI

TELESCOPE + PROJECTOR

- **30870 NIKE - Galilean telescope 3X (35 cm) + projector**
- **30871 NIKE - Galilean telescope 3X (45 cm) + projector**
- **30876 BATTERY PACK - spare**



NIKE 30870/1

This system includes Galilean telescope (CALLIOPE) and LED light projector (IRIDE)
Compatible with TETI, see page 16

30870/1

ADJUSTABLE PROJECTOR

- **30867 IRIDE - LED light projector**
- **30876 BATTERY PACK - spare**

IrIde is supplied with a compact, light, rechargeable power bank (battery), a 15 cm cable for use on head band and one 1 m cable for use from pocket



IRIDE 30867

30867

- adjustable LED light projector
- adjustable brightness intensity (10,000 and 40,000 lux at 25 cm, autonomy 6 and 4 hours)
- 6,500°K temperature
- autonomy 4 hours at maximum power
- battery pack placeable on the head band
- compatible with TETI, see page 16

SHIELD + TELESCOPE and/or PROJECTOR

- **30860 TETI - protective shield (2 shields included)**
- **30875 SET OF 5 TRANSPARENT FACE SHIELDS - spare**



TETI
30860

30870/1+ 30860

You can create beside system adding protective shield (TETI) to telescope+projector (NIKE) to telescope (CALLIOPE) or to projector (IRIDE)

PENTALED 63N THEATRE LIGHTS

PENTALED 63N

PentaLED 63N is a high-tech product designed to guarantee excellent performance levels. PENTALED 63N has 72 elliptical reflectors split into 8 modules, each containing 9 LEDs. The modules are mechanically focused by rotating the sterilizable handle. The multiplicity of the luminous sources and the elliptical geometry of the parabolas studied to reflect in the depth the light beams generated by the LEDs, grant scalytic light for a three-dimensional illumination without shadows.

63N 160,000 LUX



Comfortable use

Thanks to the principle of indirect light, the lamp oriented towards different positions does not dazzle the surgeon and the assistants. The size of the lit field is adjusted mechanically through handle according to the light required by the surgeon.

Superior lighting features

Membrane keyboard activates the following functions:

- selection of the colour temperature 5,000°K and 4,500°K
 - adjustment of the light intensity up to 160 Klx
 - on/off
 - endoLED light with colour selection (comfortable light for endoscopy intervention)
- The colour temperature of 5,000°K stimulates the surgeons' concentration, does not strain their sight, reproduces the colour of the tissues faithfully and increases the definition of the edges.

Reliable and long lasting performances

The modular construction of the electronic board that feeds the LEDs guarantees continuous light, even in the unlikely event that a LED or board component should fail. The lighting body is protected by tempered glass screen, covered by a special film avoiding any fallen down splinters in case of break.

Easy manoeuvrability

The reduced dimensions and the light reflector provide extreme manoeuvrability and stability. Smooth 360° rotation. The extremely light structure, the aluminium treated bar attached to the upper front of the cupola, the ultra-thin dome (only 13 cm) allow simple movements.

Battery group, TVCC camera, monitor holding camera on request

Every lamp can be supplied with an emergency battery group with automatic charger (hours autonomy: 2.5 (49200), 2.5 (49201), 2 (49202)), TVCC camera or monitor holding arm.

Full certification

Complies with European Directives 93/42/EEC and 2007/47/EC 'Class I - Medical Device' CE marking. Made in Italy.

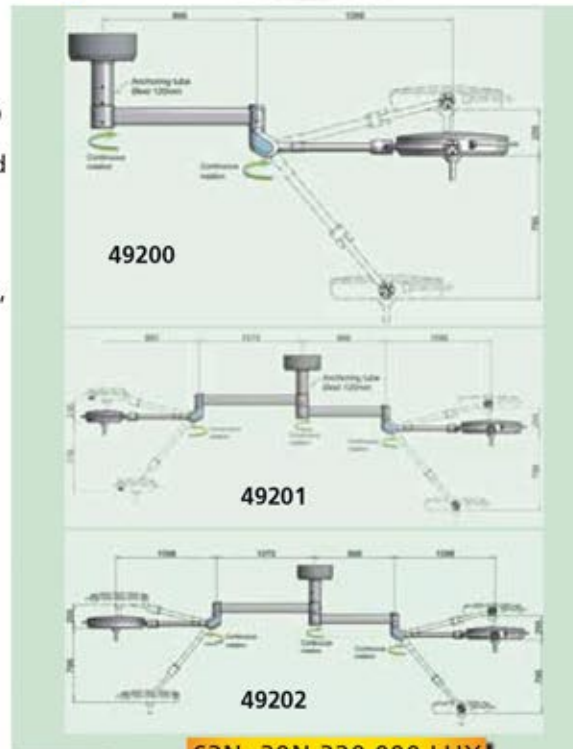

**63N+30N 320,000 LUX
(160,000+160,000 LUX)**

code	PENTALED 63N THEATRE LIGHTS - CEILING*	
49200	PENTALED 63N - 160,000 LUX	
49201	PENTALED 63N+30N double - 320,000 LUX - compact	
49202	PENTALED 63N+63N double - 320,000 LUX - plus	
*Ceiling >3.80 m needs 49220		
ACCESSORIES		
30738	Autoclavable handle - spare	
49205	Monitor holding arm - stand alone	
49206	IR remote control - single lamps	
49207	IR remote control - double lamp	
ACCESSORIES TO BE ORDERED WITH LIGHT		
49210	Battery group with automatic charger for 63N	
49211	Battery group with automatic charger for 63N+30N	
49212	Battery group with automatic charger for 63N+63N	
49213	STD TVCC camera for 63N - including lamp setup	
49214	HD TVCC camera for 63N - including lamp setup	
49215	Monitor holding arm - integrated with lamp	
49220	Special structure for high ceiling (>3.8 m)	



**63N+63N 320,000 LUX
(160,000+160,000 LUX)**

TECHNICAL SPECIFICATIONS				
			63N	30N
Performance	Light intensity at 1 m distance (Ec)	klx	160	160
	Colour temperature: double selection	°K	4,500/5,000	4,500/5,000
	Colour rendering index (CRI)	Ra	96	96
	Light field diameter adjustable from/to	cm	21-42	18-30
	Total radiated energy Ee where the illumination reaches max level	W/m ²	543	543
	Number of LED		72	30
	Diameter and focus adjustment		manual	manual
	Depth of illumination IEC 60601-0-41 L1+L2 at 60%	cm	46	55
	Depth of illumination IEC 60601-0-41 L1+L2 at 20%	cm	108	115
	Control of illuminance	%	25-100	25-100
Electrical data	Endo LED light intensity min-max	klx	5-20	9-25
	Operating power (VAC)	V	100-240	100-240
	Operating power Vdc	V	24	24
	Electrical absorbed power	VA	145	70
	Frequency	Hz	50/60	50/60
General data	Average LED life	h	50,000	50,000
	Colour	RAL	9003	9003
	Minimum height of the room	cm	260	260
	Outer reflector diameter	cm	63	40
	Useful lighting surface	cm ²	1710	712
	Weight	kg	45	35

GIMALED O.T. LED LIGHTS - 160,000 LUX

GimaLed light with **81 Led**: sophisticated design which combines excellent lighting features with exceptional mechanical characteristics for extra soft movement.

Deep light: 27 inner fixed Leds for central illumination and 54 Leds (six modules of nine Leds each) moved by servo-motor, allow surgeon to adjust light field diameter.

Shadowless light: 81 Leds arranged on a round surface grant the best light emitting surface and avoid any shadow effect caused by any interposition between light beams and lighted surface.

Bright light: two colour selections, 4,000K and 4,600K, made of white Leds only, no coloured shadow effect. Light intensity of 160,000 Lux.

Major features

- collimated light beams for a working distance from 70 to 160 cm
- high colour rendering index (CRI) 95, R9 >90
- optimisation of LED thermal management by heat dissipation convection to avoid illuminance reduction during surgery
- PMMA optical lenses and polycarbonate protective screen
- Zener to grant light in case of even one Led failure
- reduced consumption, high efficiency
- optional pre-wired system for Wi-Fi HD camera

code	GIMALED
49180	GimaLed-mobile
49181	GimaLed-mobile with battery group and automatic charger
49182	GimaLed - ceiling*
49183	GimaLed - ceiling* - double
49197	Autoclavable handle
49205	Monitor holding arm - stand alone
49220	Special structure for high ceiling (>3.8 m)
49185	GimaLed wall remote control
49186	Set up kit for HD Wi-Fi camera**
49187	HD Wi-Fi camera - need 49186
Battery group available on request for all models	

*Ceiling >3.80 m needs 49220

**Installation must be done by Gima at the order

Small overall dimensions of cupola, perfectly balanced, ensure stable adjustment.

Ergonomic grip in the cupola and in the protective screen to hold and move the lamp



Motorised light field diameter adjustment through **49183** handle or touch pad at the side of the cupola

Thin and easy-to-adjust reflector

160,000 LUX

49180

TECHNICAL SPECIFICATIONS

Light intensity at 1 m distance (Ec)	Klx 160
2 Colour temperature - switchable	*K 4,000 and 4,600
Colour rendering index (CRI)	Ra 95
Light field Ø (adjustable)	11-35 cm
Light field Ø where illuminance reaches 10% of Ec (d10)	260 mm
Light field Ø where illuminance reaches 50% of Ec	150 mm
Total radiated energy Ee where illumination reaches max level	556 W/m ²
Average LED life	hours 50,000
Power supply:	100-240 V - 50-60 Hz - 61-71 W
Regulations:	IEC 60601-2-41 - 93/42/EEC
Made in Italy	

PENTALED 30E SURGERY LAMP 160,000 LUX

LED LIGHT INNOVATIVE TECHNOLOGY

A compact size hi-tech product that guarantees great performance levels. It has 30 elliptical reflectors split into 6 modules each containing 5 LEDs, providing 160,000 LUX - selectable 4,500 °K - 5,000 °K. By simply pressing the digital key, the surgeon can choose two different white light temperatures

- **E-view**. Innovative lens allows the surgeon to expand/narrow the illuminated operating field electronically, without altering intensity of light.

- **E-comfort**. The indirect LED's creates 3D shadowless illumination of the operating field, no risk of dazzling

- **E-white**. Only white LED's to avoid risk of perception of colour temperature variations or coloured shadows

- **E-deep**. Centre of light is fitted with extra LEDs module specifically designed to reflect deep light. This means that surgeon can work with perfect 3D lighting.

Battery and high definition camera on request. Optional battery group with automatic charger (4 hours autonomy) and high definition integrated camera (for ceiling and wall models only).

code	PENTALED 30E
30780	PentaLed-mobile
30779	PentaLed-mobile with battery group and automatic charger
30781	PentaLed - wall
30782	PentaLed - ceiling*
30783	PentaLed - ceiling* - double
30785	Autoclavable handle - up to serial number 12071
30738	Autoclavable handle - since serial number 12072
49205	Monitor holding arm - stand alone
49220	Special structure for high ceiling (>3.8 m)
Battery group available on request for all models	

*Ceiling >3.80 m needs 49220

An aluminium ring runs around the dome for easier positioning



30783

Aluminium structure tested for over 40,000 movements



30780

RIMSA

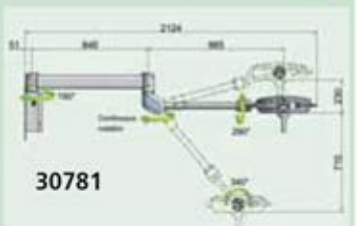

30781

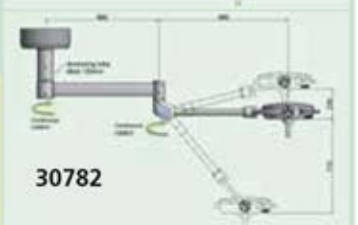

30782

TECHNICAL SPECIFICATIONS

Adjustable light intensity at 1 m distance (Ec)	Klx 160	Total radiated energy Ee where illumination reaches max level	W/m ² 540
Colour temperature - switchable	*K 4,500 to 5,000	Average LED life	hours 50,000
Colour rendering index (CRI)	Ra 96	Power supply:	100-240 V - 50-60 Hz - 70 VA
Light field (electronically adjustable)	16-30 cm	Regulations:	IEC 60601-2-41 - 2007/47/EC
Light field Ø where illuminance reaches 10% of Ec (d10)	mm 160	Made in Italy	
Light field Ø where illuminance reaches 50% of Ec	mm 80		

TRIS LED LIGHTS - 130,000 LUX

SHADOWLESS THEATRE LED LIGHT

Shadowless lamp with exceptional technical performance and flexibility of use. Suggested for small surgery, gynaecological and first aid surgeries. Cupola with four inner modules, each with 7 LEDs (total of 28 LEDs) displayed in a radial layout with lenses allowing shadowless and deep light. LEDs modules guarantee continuous light, even in the unlikely event that a LED should fail. Extremely easy to handle and stable in position. Focusing and adjusting the diameter of the illuminated area takes place by rotating the sterilizable handle at the centre of the reflector.

Battery group with charger: 4 hours autonomy, 6 hours recharging.

TECHNICAL SPECIFICATIONS

Light intensity: 130,000 lux at 1 m distance
 Diameter of the reflector: 40 cm
 Adjustable diameter of illuminated field: 26-38 cm
 Depth of illumination IEC 60601-2-41 (L1+L2) at 20%: 148 cm
 Depth of illumination IEC 60601-2-41 (L1+L2) at 60%: 82 cm
 28 LEDs - life 50,000 hours
 Colour temperature: 4,300° K ± 5%
 CRI 96 (Chromatic Rendering Index)
 Power supply: 100-240V - 50/60 Hz - 70 VA
 Total radiated energy Ec 460 W/m²
 Weight (ceiling, mobile, wall) kg: 35 - 32 - 27
 Minimum height of the room (ceiling version): 260 cm
 Norms: IEC 60601-1, IEC 60601-2-41 - MDD 93/42/EEC
 Made in Italy Warranty: 12 months
 mechanical components warranty: 10 years



49110

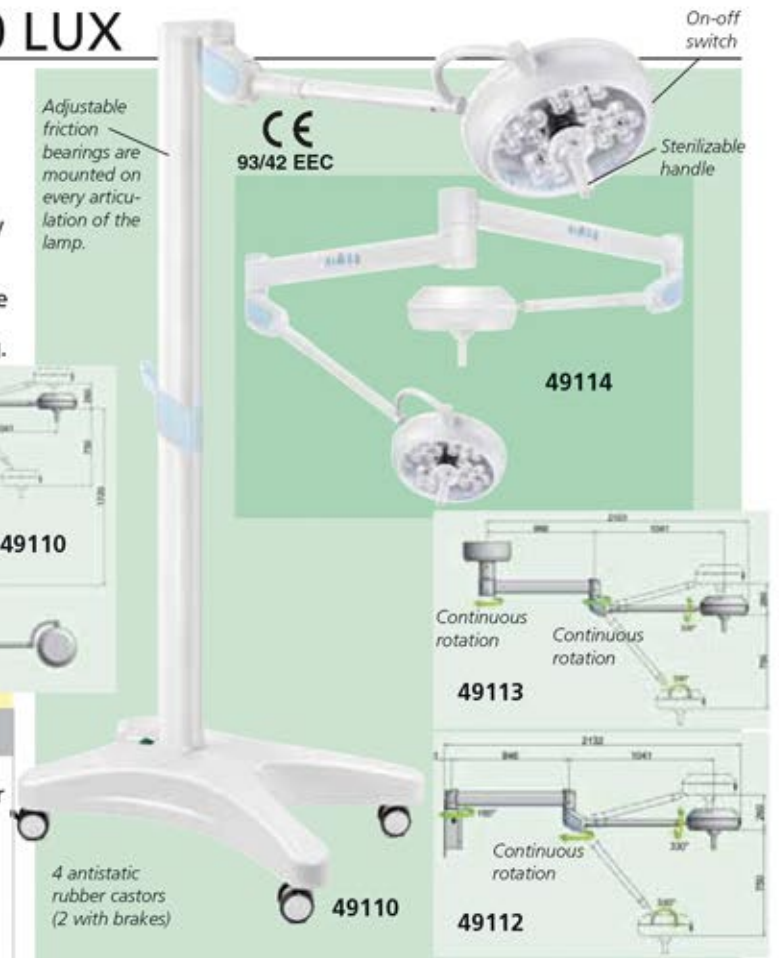

49114

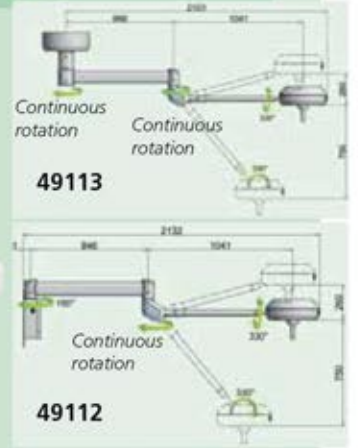

49113

49112

code	TRIS SCIALYTIC LED LIGHTS
49110	Scialytic light - mobile stand
49111	Scialytic light - mobile with battery group and automatic charger
49112	Scialytic light - wall
49113	Scialytic light - ceiling**
49114	Scialytic light double - ceiling**
49220	Special structure for ceiling >3.80 m
30738	Spare autoclavable handle - for scialytic 3 bulbs
Battery group available on request for all models*	
*to be ordered with light **Ceiling >3.80 m needs 49220	

SATURNO LED LIGHTS - 30,000 LUX



Autoclavable handle

RIMSA

SATURNO LED MINOR SURGERY LAMP

SATURNO is a shadow-less type lamp suitable for small surgery, gynaecology and examination. Available in three versions: mobile with castors, wall and ceiling.

- light beams are generated from 9 LEDs - 2.5 W each
- heat is dissipated through aluminium cover reflector
- selection of 2 different white light temperatures: 5,000 °K and 4,500 °K
- light intensity adjustable at 6 different levels through front digital panel
- luminous intensity 30,000 LUX at 1 m. Diameter of illuminated field 28 cm
- adjustable friction bearing are mounted on every articulation of the lamp
- thanks to optical concept, no need to be focus adjusted

Battery group with charger: 4 hours autonomy, 6 hours recharging.

TECHNICAL SPECIFICATIONS

Light intensity at 1 m distance	Lux	30,000
Colour temperature adjustable	K°	4,500/5,000 ± 5%
9 LEDs	W	2.5 each
Average LED life	hours	50,000
CRI (chromatic rendering Index)	Ra	96
Diameter of illuminated field	Ø cm	28
Depth of illumination IEC 60601-2-41 (L1+L2) at 20% of Ec	cm	228
Depth of illumination IEC 60601-2-41 (L1+L2) at 60% of Ec	cm	136
Total radiated energy Ec	W/m ²	105
Diameter of the reflector	cm	19.5
Useful lighting surface of the cupola	cm ²	65
Weight (ceiling, mobile, wall)	kg	12 - 14 - 13
Power requirements	V, Hz	100-240, 50-60
Minimum height of the room (ceiling version)	cm	244
Standards: IEC 60601-1 IEC 60601-2-41, MDD 93/42 CEE, medical device of Class I		
Warranty 12 months - mechanical components warranty 10 years		Made in Italy

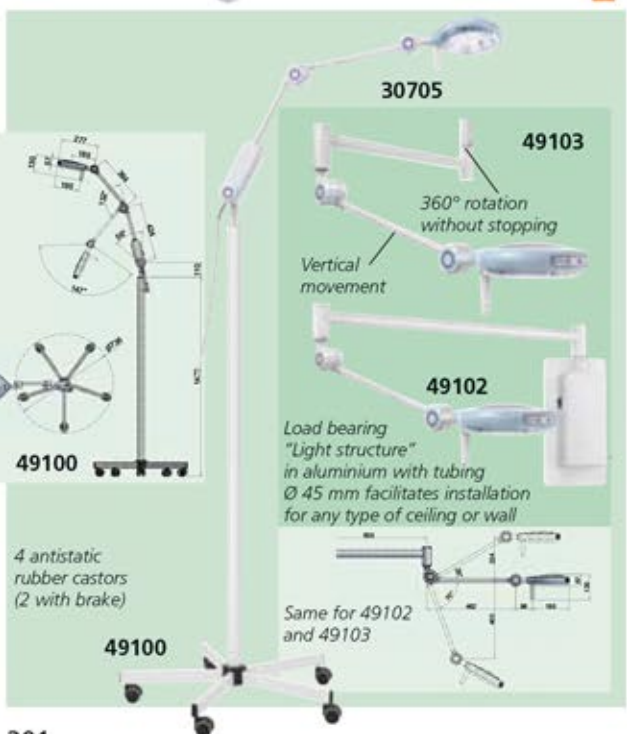

30705

49103

360° rotation without stopping

Vertical movement

49102

Load bearing "light structure" in aluminium with tubing Ø 45 mm facilitates installation for any type of ceiling or wall

49100

4 antistatic rubber castors (2 with brake)

49100

Same for 49102 and 49103

code	SATURNO LED LIGHTS
49100	Saturno LED light - mobile stand
49101	Saturno LED light - mobile stand with battery group
49102	Saturno LED light - wall
49103	Saturno LED light - ceiling*
49105	Special structure for high ceiling (>3.20 m)
30797	Spare autoclavable handle for Saturno
Battery group with automatic charger available on request for all models (to be installed at order)	

*Ceiling >3.20 m needs 49105

PENTALED 12 - 100,000* LUX, PENTALED 28 - 120,000 LUX

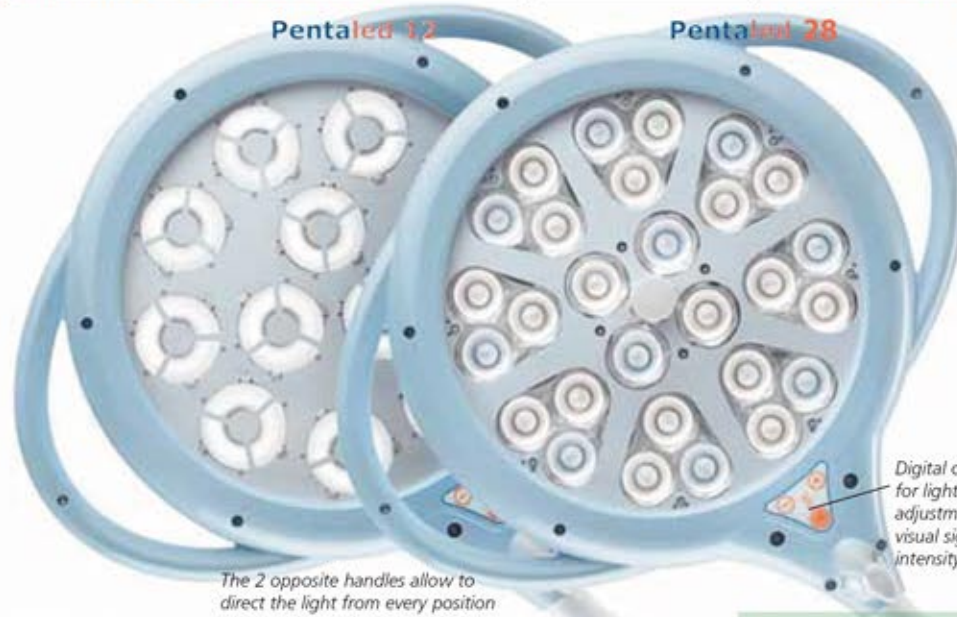

PentaLED 12

- 100,000* Lux at 1 m
- indirect light with 12 elliptic reflectors. They reflect the light rays emitted by the LEDs. Does not dazzle and does not strain eyes.

*Since January 2018. 70,000 Lux up to December 2017

PentaLED 28

- 120,000 Lux at 1 m
- direct light with 28 LED lens
- double colour selection: 4,500 or 5,000 K
- light field adjustment

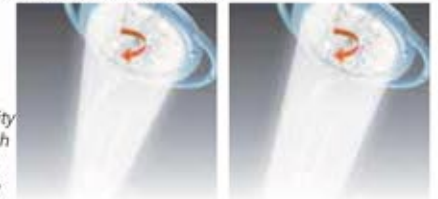

Digital control for light intensity adjustment with visual signal of intensity set up

Light field adjustment for PENTALED 28

The 2 opposite handles allow to direct the light from every position

PENTALED

PENTALED is a perfect combination of technological developments, innovation, ergonomy and compact design, ultra-light and handy structure. Five versions available (trolley, ceiling, ceiling double, trolley with battery group and wall) and technical performances make PENTALED suitable for precision operations, diagnostic use, surgical rooms and small surgeries. Battery group, with an autonomy of 3 hours, is available on request also for wall and ceiling models.

Cold LED light

Bright and cold light reproduces colours faithfully, assuring excellent definition of details.

Ergonomic

PENTALED can be easily positioned by rotation on 4 axes:

- the dome has a full-circle 360° rotation
- the arm moves vertically thanks to a spring balancing system
- the reflector can be rotated on the vertical and horizontal axis.

Movements are possible through the sterilizable handle.

50,000 hours life time

The low power supply current and the heat dispersion through aluminium dome allow the LED a 50,000 hours lifetime.

Light intensity adjustment

Light intensity adjustable through digital control



The ultra-flat lighting body is equipped with ultra-resistant polycarbonate screen which guarantees protection against accidental collisions.



The dome can be adjusted by the sterilizable handle

code	PENTALED 12 LEDS
30787	PentaLED 12 - trolley
30789	PentaLED 12 - ceiling* (for ceiling 2.57 to 3.33 m)
30790	PentaLED 12 - wall
30791	PentaLED 12 - trolley with battery group and automatic charger
30792	PentaLED 12+12 - ceiling* double
30788	Special structure for ceiling > 3.34 m
30793	Autoclavable handle - spare
code	PENTALED 28 LEDS
49115	PentaLED 28 - trolley
49116	PentaLED 28 - ceiling* (for ceiling from 2.57 to 3.33 m)
49117	PentaLED 28 - wall
49118	PentaLED 28 - trolley with battery group and automatic charger
49119	PentaLED 28+28 - ceiling* double
30788	Special structure for ceiling > 3.34 m
30793	Autoclavable handle - spare

*Ceiling >3.34 m needs 30788

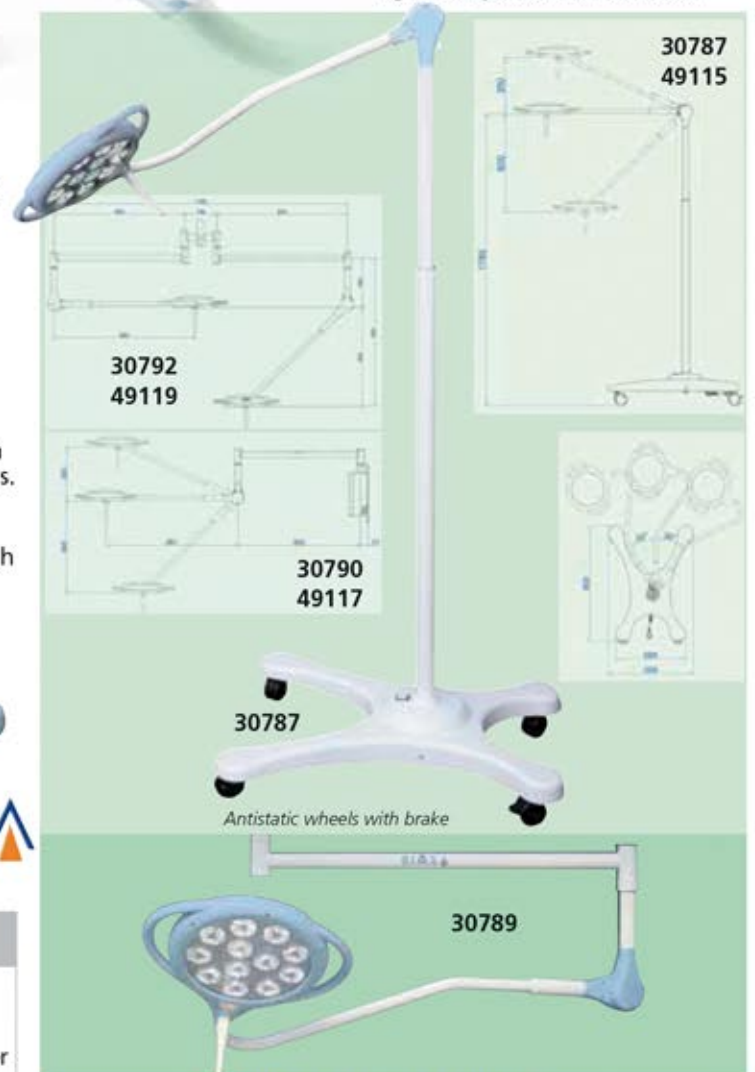

	TECHNICAL SPECIFICATIONS	
	PENTALED 12	PENTALED 28
Light intensity at 1 m distance	Lux 100,000	120,000
Colour temperature	K° 4,500	4,500/5,000
LED	No. 12	28
Average LED life	hours 50,000	50,000
CRI (Chromatic rendering Index)	Ra 96	92 (5,000K) 96 (4,500K)
Diameter of illuminated field	Ø mm 160	135-270
Depth of illumination (L1+L2) at 60%	cm 87	58
Total radiated energy Ec	W/m² 350	404
Weight (ceiling, mobile, wall, double)	kg	18-13-12-20
Power supply	V/Hz	100-230V, 50-60Hz
Standards: IEC 60601-2-41, 2007/47/EEC, medical device of Class I		

PRIMALED COLD LIGHT LAMP - 80,000 LUX AT 50 cm

PRIMALED COLD LIGHT LAMP WITH 9 LED LENSES

Appealing design and advanced technology.

Design: the round and ultra-flat shape of the light makes the product ergonomic and suitable for any type of installation, from the doctor's surgery to the intensive-care unit.

Ergo-Spring: the movement of the articulated tubular arm is servo-assisted by a torsion spring which ensures ease of movement and stability.

80,000 lux: unique performance with 80,000 lux at 50 cm.

Light intensity adjustment: six different adjustment levels by the keys on the frontal panel.

4,500-5,000 °K Colour temperature selection: the comparison between the two colours (K) increases the visibility of details. **Shadow suppression:** the radial layout of the lenses and the large-diameter lamp (195 mm) allow shadow suppression and three-dimensional lighting.

Adjustable courtesy-light: integrates ambient light with traditional concentrated light.

Sterilizable removable grip: allows best asepsis.

Cold light: the reduced emission of IR rays by the LEDs as well as the low power consumption allow minimum heat emission.

Disinfection: the smooth and rounded shape of the dome and structure make it easy to clean and disinfect.

50,000 hours LEDs life: the top aluminium dome allows heat exchange, thus reducing the work temperature and considerably increasing the life cycle of the single LEDs.

Fully certified: complies with IEC 60601-1 and 60601-1-2 general medical standards and to special standard IEC 60601-2-41 93/42 EEC and 2007/47 EC and is CE marked as a Class I medical device.

Mechanical testing and user safety: die-cast aluminium and tubular steel structure. The articulated arm has undergone mechanical testing for 40,000 continuous movements to ensure maximum safety for the user during use.

Light continuity: the modular design of the LED power circuit ensures light continuity even in case of a LED fault.

The following functions are controlled by the keys on the membrane keyboard:

- on/off
- selection of the 5,000°K and 4,500°K colour temperatures
- 6-level adjustment of the light intensity
- courtesy light

code	PRIMALED
30777	Primaled light - trolley
30753	Primaled flex light - trolley
30778	Primaled light - ceiling* (for ceiling 2.44 to 3.20 m)
49105	Special structure for high ceiling (>3.20 m)
30784	Primaled light - wall
30786	Primaled light - rail (25x10) and clamp
30797	Autoclavable handle
	Battery group available on request

*Ceiling >3.20 m needs 49105

TECHNICAL SPECIFICATIONS

LED life: 50,000 hours
 Light intensity: 80,000 lux at 50 cm, 20,000 lux at 1 m
 Colour temperature: 4,500-5,000 °K Colour rendering index: 95 Ra
 Illuminated field at 50 cm: Ø 140 mm
 External diameter of the reflector: 190 mm
 Temperature increase in the operating area at 1 m: 1°C
 Adjustable height with castors: 600 mm - max 1,600 mm
 Power supply: 80-240V - 50/60 Hz Electric absorption: 21VA
 Weight: 10 kg (trolley included) Made in Italy



RI-MAGIC® HP LED LIGHT

- 49050 RI-MAGIC® HP LED - desk
- 49051 RI-MAGIC® HP LED - trolley
- 49052 RI-MAGIC® HP LED - wall

High performance medical LED light for examination and procedures.

- high performance LED, 6,500 °K
- lifetime of the lamp up to 50,000 hours
- significantly reduced heating and energy loss
- focusing device at the front of the light head
- highly flexible, long special arm can be bent in all directions
- rheostat handle for infinitely variable regulation of light intensity.

Manual in: GB, FR, IT, ES, DE, RU.
 Made in Germany.

49051

Riester

Sturdy mobile base made of fiber glass and chrome plated pole.
 Low friction antistatic castors with brake
 Ø 53 cm mobile base

TECHNICAL SPECIFICATIONS

Distance:	1,000 mm	800 mm	600 mm	400 mm	200 mm
Lux max:	15,000	20,000	30,000	45,000	55,000
Circle of light max Ø:	340 mm	270 mm	215 mm	155 mm	90 mm
Circle of light min Ø:	40 mm	35 mm	30 mm	25 mm	20 mm
Operating voltage:	100-240 V,	50-60 Hz			

MONOLED LED LIGHT

- 30715 MONOLED LED LIGHT - on trolley

High performance LED light for minor surgery and examination.

Flexible arm and versatile use.

Arm length 70 cm (35 cm flexible, 35 cm rigid).

Supplied on sturdy 5 castors stand for easy movability. Schuko plug. Made in Italy.

CE
93/42

40,000 LUX

TECHNICAL SPECIFICATIONS

Consumption:	16 W
Life of the bulbs:	30,000 hours
Light intensity at 50 cm:	40,000 lux
Colour temperature ± 5% at 1 m:	7,000 °K
External Ø of the reflector:	120 mm
Colour:	cold white
Weight	11 kg
Operating voltage	175-250 V
Operating Hz	50/60 Hz
Norms	IEC 60601-1



HALOGEN AND LED LIGHTS FOR EXAMINATION AND MINOR SURGERY

WITH 2 BULBS

40,000 LUX

Electronic transformer integrated in the base with double safety fuse

Adjustable height 60-160 cm

30747

RIMSAL

35,000 LUX LED

The flexible arm (60 cm) ensures easier light positioning and is covered with a smooth white shrink-wrap sheath for easier cleaning and disinfection

30759

30,000 LUX HALOGEN

Adjustable height 60-160 cm

30760

Manual in: GB, FR, IT, DE, ES, PT

50,000 LUX - Halogen
15,000 LUX - LED

MIMSAL

30754

Height 50 cm (arm) + 95 cm (trolley)

30754

- **30747 SOLESUD 2 on trolley - halogen**
 - **30748 SOLESUD 2 wall - halogen**
- Suitable for gynaecology, examination and head-bed. Aluminium reflector equipped with 2 halogen dichroic bulbs, 20W 12V 10° IRC protected by a tempered glass, hermetically sealed against dirt and fluid spray and with ergonomic handle for movement. Bulbs switch on simultaneously and, in case one breaks, light is always assured. Arm movement servo-assisted by a torsion spring provides lightweight movement and stability of position. A light beam of 180 mm diameter at a distance of 50 cm allows precise and reliable examinations. Base with 5 rotary spokes, 900 mm high. 3 Pin British Plug available on request. Made in Italy.
- **30769 SPARE TROLLEY - base Ø 61 cm**
 - **30775 RAIL CONNECTION WITH CLAMP**
 - **30764 SPARE BULB SOLESUD 2 - 20 W**

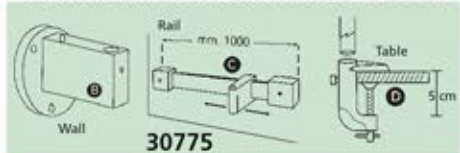

- **30760 SIMPLEX on trolley - halogen**
 - **30761 SIMPLEX wall** - halogen
 - **30762 SIMPLEX table with clamp**
 - **30763 SIMPLEX rail** - halogen
- Versatile lamp equipped with a halogen dichroic bulb 35W 12V placed inside the aluminium reflector and protected by a tempered glass. Electronic transformer integrated in the base with lead retainer with spiral protection and bipolar light switch with green indicator light. Ceramic fuse offers extra protection.
- **30759 SIMPLEX on trolley - LED**
 - **30749 SIMPLEX wall** - LED
 - **30752 SIMPLEX table with clamp** - LED
- Thanks to 3 independent light sources shadow can be reduced and provide a deep cylindrical light with highly reduced heat irradiation. Each LED integrates a resistance to ensure the continuous operation of the lamp even in the rare case of a LED fault. Other specifications as halogen model. Made in Italy.
- **30766 SPARE BULB SIMPLEX - IRC 35 W**
 - **30768 SPARE TROLLEY - base Ø 62 cm**
 - **30775 RAIL CONNECTION WITH CLAMP**

- **30754 LUXIFLEX on trolley - halogen**
 - **30756 LUXIFLEX on trolley - LED**
- Stylish and versatile light for examination and minor surgery procedures in health-centres, clinics and hospitals. Suitable also for veterinary examinations and procedures. Safe low voltage operation without infrared radiation. Electronic transformer lodged at the bottom of the lamp. Flexible arm and 5 castors trolley allow easy use and movability. Class II. Made in Europe.

- **30757 SPARE BULB LUXIFLEX - halogen**

30712

4 hours on, 30 min off 3 pin plug

37,000 LUX

30714

Continuous use Schuko plug

20,000 LUX

Arm length 70 cm (35 cm flexible 35 cm rigid)

30714

- **30712 MINIMED 2 ON TROLLEY - halogen**
 - **30714 MINIMED 2 ON TROLLEY - 12 LED**
- Low voltage and high definition, intense light. Flexible arm for versatile use. Supplied on a sturdy 5 castors stand for easy movability. Made in Italy.
- **30744 SPARE BULB - 50 W - halogen**

Model	SOLESUD 2		SIMPLEX		LUXIFLEX		MINIMED 2	
Type of lighting	halogen	halogen	halogen	LED	halogen	LED	halogen	LED
Consumption (Watt)	2x20	35	3x1.4	35	10	50	7	
Life of the bulbs (hours)	5,000	5,000	50,000	5,000	25,000	7,000	30,000	
Light intensity at 50 cm (lux)	40,000	30,000	35,000	50,000	15,000	37,000	20,000	
Light intensity at 1 m (lux)	8,000	8,000	13,000	-	-	-	-	
Colour temperature ± 5% at 1 m (K)	3,000	3,000	4,200	4,000	3,000	3,100	7,000	
Light field size at 50 cm (Ø mm)	180	100	140			60	60	
External Ø of the reflector (mm)	140	105	86					
Colour	white	white	white	white	white	cold white	cold white	
Norms	IEC 60601-1	IEC 598-2-25	IEC 60601-1	EN 60601-1-2	IEC 60601-1	IEC 60601-1	IEC 60601-1	
Marks	CE 93/42	CE 2006/95	CE 93/42	CE 93/42	CE 93/42	CE 93/42	CE 93/42	
Weight (kg)	6	5	5			9	9	
Operating voltage V	230	230	100-230	230	230	230	190-265	
Operating Hz		50/60		50	50	50/60		
Operating voltage on request V-Hz				110-60*				

*minimum 50 pcs.

MAGNIFYING FLUORESCENT COLD LIGHTS - 3 DIOPTRES

GIMANORD

Magnifying glass self-illuminating fluorescent cold light 3 dioptres (0.75X). Suggested for dermatology and whenever magnifying is required. It is equipped with a biconvex magnifying lens in optical glass Ø 120 mm. The cold fluorescent light allows prolonged use. Polycarbonate screen for protection of the light source. Available also with wall support. Medical device Class I.

TECHNICAL SPECIFICATIONS

Type of lighting	fluorescent
Consumption	22 W
Life of the bulbs	6,000 hours
Light intensity at 50 cm	550 lux
Colour temperature	4,550 °K
External diameter of the reflector	230 mm
Temperature increase at 1 m	0 °C
Norms	IEC-60601-2-41
Marks	CE 93/42
Weight	7 kg
Operating voltage V-Hz	220-240 V, 50 Hz
Adjustment height with castors base:	
min-max	60-180 cm



code	MAGNIFYING LIGHTS
30750	GIMANORD desk model - with clamp
30751	GIMANORD on trolley
SPARES AND FIXING SYSTEMS	
30767	Spare fluorescent lamp - 22 W
30771	Spare plexiglass shield
30769	Trolley - spare (A) - base Ø 61 cm
30774	Wall connection (B)
30775	Rail connection with clamp (C)
30776	Table connection (D)



LED MAGNIFYING LAMP - 5 DIOPTRES

- 30737 LUPA LED MAGNIFYING LIGHT - trolley
 - 30739 LUPA LED MAGNIFYING LIGHT - desk with clamp
- Smartly designed cold light LED lamp with 5-dioptres magnification. Generates a light without shadow. 5 wheels base and articulated arm allow easy movement. Manual in GB, FR, IT, ES, PT, DE. Medical device Class I. Made in Europe.

TECHNICAL SPECIFICATIONS

Type of light:	80 LED - HF 8 W
Dioptres:	5
Lens:	Ø 12.7 cm
Colour temperature:	6,500 °K
Operating voltage:	230 V - 50 Hz
Class I	
Electrical security:	UNI EN 60601-1 (1990)
Electromagnetic compatibility:	EN 60601-1-2 (1993)
Lamp life:	40,000 hours



LED MAGNIFYING LAMP - 3 DIOPTRES

- 30736 DERMALED MAGNIFYING LAMP
- Cold light LED lamp with 3 dioptres magnifying lens and brightness adjustment. It comes with a high stability 5 wheels base and an articulated arm for easy movement and fixing of the lamp. Made in China.

TECHNICAL SPECIFICATIONS

Type of light:	LED
Voltage:	8 W
Dioptres:	3 (large glass)
Colour temperature:	8,000-9,000 °K
Light intensity at 20 cm:	2,000 lux
Operating voltage:	100-240 V - 50/60 Hz
Net/Gross weight:	10-12 kg



VISTA WOOD BLUE LIGHTS: TROLLEY AND MANUAL

- 31196 VISTA WOOD LAMP - handle
 - 31197 VISTA WOOD LAMP - trolley
- A Wood lamp is a diagnostic tool to diagnose the condition of skin. Different skin conditions under ultraviolet rays of the Wood lamp appear in different colours. These models have polished glass magnifying lens 10x6 cm - 3 dioptries. 9W special compact fluorescent tube at approximately 360 nm wavelength. Operating voltage: 230 V - 50 Hz. Manual in GB, FR, IT, ES, PT, DE. Made in Spain.
- 31201 FLUORESCENT TUBE 9W - spare for 31196-31197



MACRO LENS 12X

- 31155 SMARTPHONE MACRO LENS 12X
- Macro lens 12X for allergists, dermatologists, phlebologists, aesthetic surgeries. Can be mounted on any smartphone to take magnified images. Supplied with clip compatible with any smartphone, 10x10 cm wipe and multilanguage manual (GB, FR, IT, ES, PT, DE, PL, GR).



MIMSAL

ECONOMIC WOOD LAMP



- 31200 WOOD LAMP
- Ultraviolet light for skin condition analysis. Size 30x21x7 cm. Made in China.
- 31202 FLUORESCENT TUBE - spare

POCKET WOOD LIGHT



- 31189 POCKET WOOD LIGHT
- Pocket ultraviolet light, to detect skin disorders. Provided with replaceable fluorescent lamp. Power 6 W. Works with 4xAA batteries with 4-6 hours autonomy.
- 31190 FLUORESCENT TUBE - spare

DIGITAL Wi-Fi POLARISED DERMATOSCOPE, CAPILLAROSCOPE, MICROSCOPE

An innovative line of handheld colour digital microscopes: dermatoscope with polarized filter, capillaroscope and iridoscope with Wi-Fi wireless transmission. Small, easy to operate light and portable. They can be used with all the most popular smartphones, tablet and PC.

Basic software for acquisition of photos, videos, measurements google/apple applications included. Designed in Italy, manufactured in China. Directive 93/43/CEE - Medical device Class I (only 32181 and 32183).



Professional software available for creation of patient database, image comparison and medical referrals

- 32181 Wi-Fi DERMATOSCOPE with polarized filter
- 32182 PROFESSIONAL SOFTWARE for 32181

DERMATOSCOPE SPECIFICATIONS	
Magnification:	5X to 200X
Light source:	8 adjustable white LED
Lens:	High definition microscopy lens



- 32183 Wi-Fi CAPILLAROSCOPE

CAPILLAROSCOPE SPECIFICATIONS	
Magnification:	500X to 600X
Light source:	8 adjustable white LED
Lens:	High definition microscopy lens



- 32184 Wi-Fi MICROSCOPE
- Advised for iris scanning

MICROSCOPE SPECIFICATIONS	
Magnification:	30X
Light source:	2 adjustable white LED+ 2 adjustable yellow LED
Lens:	High definition microscopy lens

TECHNICAL SPECIFICATIONS	
Operation system	Windows (XP and following), Mac (OSX 10.7 following), iOS, Android (it can be used by Wi-Fi or USB)
Photo and video resolution	1.3 MPixels - 1280x1024 (MJPG), 640x480 (MJPG), 320x240
Frame rate	15 fps 1,280x1,024, 30 fps 640x480 320x240
Wi-Fi wireless transmission distance	Up to 5 m
Power consumption	Max 2.5 W
Li-ion battery	Continuous working time - appx. 2 hours, full charging time - appx. 2 hours
Power source - Size - Weight	DC 5.0V / 1A - Ø 36x142 mm - 88 g

CAMERA	
Camera sensor	CMOS 1/4"
Optical features	Exposure: Auto, Gamma: Auto, White balance: Auto, Black reference: Auto
PROFESSIONAL SOFTWARE	
Operation system:	Windows XP and next
Software language:	GB, IT

STANDARD ACCESSORIES	
Caps of contact (only for 32181)	
USB AC adapter	
USB cable	
Quick manual	
Plastic stand	
Line calibration ruler	
Manual (GB, FR, IT, ES, DE)	
CD basic software Win (GB, IT, ES, DE, PT, RU, BG, TH, JP, KR), Mac (GB)	

HEINE DELTA 20® T LED^{HQ} DERMATOSCOPES 10X - 16X

- 31165 HEINE DELTA 20® T LED^{HQ} DERMATOSCOPE 2.5V for polarization and immersion - K-262.10.118
- 31161 HEINE DELTA 20® T LED^{HQ} DERMATOSCOPE 3.5V (Li-ion) for polarization and immersion with rechargeable handle for mains socket and USB cable - K-262.28.388

Precision HEINE Optics - high quality, achromatic optical system provides unsurpassed sharpness and resolution. Focusing system provides from 10X to 16X magnification for detection of even the smallest details and structures.

LED in HQ - the new standard in LED illumination defining optimal light intensity, homogeneity and colour rendering for each individual examination - Colour temperature: 5.000 K, Colour Rendering Index (CRI) > 80 on a scale of 100. This ensures true tissue colour for the most accurate diagnosis.

Toggle between polarised and non-polarised illumination modes - conveniently alternate between two modes with the press of a button - no exchange of contact plates necessary. Allows recognition of the "Blink Sign" when observing crystalline structures and presence of milia cysts, increasing diagnostic function.

Optional small contact plate for difficult to access lesions.

Digital documentation capabilities - Heine SLR photo adapter allows to connect any Delta 20 dermatoscope to major brands of digital cameras.

LED Thermal Management - ensure long-term performance and product stability. Carefully selected and applied heat-diffusing materials guarantee up to 50.000 hours.



Supplied with hard case, dermatoscopy compendium, 10 ml oil.

- 31162 HEINE DELTA T LED DERMATOSCOPE HEAD with contact plate with graduated scale - K-008.34.221 (can be used with any Heine Beta handle). Supplied with compendium.
- 31179 SMALL CONTACT PLATE Ø 8 mm - K-000.34.205
- 31171 SLR PHOTO ADAPTOR - for Canon
- 31173 SLR PHOTO ADAPTOR - for Nikon
- 31174 SLR PHOTO ADAPTOR - for Olympus
- 31169 ADAPTOR CORD - 1.30 m
- 31183 DERMATOLOGY OIL - box of 4 bottles of 12.5 ml

HEINE MINI 3000 DERMATOSCOPES

- 31184 HEINE MINI 3000 XENON-HALOGEN DERMATOSCOPE 10X - D-001.78.107
- 31160 HEINE MINI 3000 LED^{HQ} DERMATOSCOPE 10X - D-008-78-109 - same as 31184, with the addition of:

Pocket dermatoscope with high-quality optics, 10X magnification with focusing optics, metal head.

Xenon Halogen bulb. Concentrated, bright light for uniform illumination with exact colour rendering.

High quality colour-neutral optic system with achromatic lenses, provides sharp images.

Contact plate without scale.

Supplied with dermoscopic compendium and oil. Operates with AA batteries or rechargeable batteries (31693) + Mini 3000 NT charger (31692) not included.

High-performance bright and homogeneous LED illumination with an excellent colour rendering (index >95). Colour temperature 4,000 K.

Twice brighter light compared to Xenon Halogen.

Maintenance free.

Fade-out function: reduces illumination intensity with battery level to let you know when to replace.

Up to 10 hours operation time.

- 31692 HEINE MINI 3000 NT CHARGER - X-001.99.484
- 31693 BATTERY+BASE - X-001.99.487 + X-001.99.488



HEINE NC1 LED DERMATOSCOPE

- 31158 HEINE NC1 LED^{HQ} DERMATOSCOPE - D-008.78.132

LED thermal management - LED illumination systems require thermal management. Carefully selected heat-diffusing materials guarantee consistent quality and performance for up to 50.000 hours.

Aluminium frame - more stability to the device for a long working life.

Non-Contact Dermatoscope - examining patients without touching the skin saves time and provides more professional distance between examiner and investigation area.

Polarised Illumination for detailed views of the crystalline and vascular structures. Allows examinations without contact liquids.

Precision HEINE Optics with 6X magnification - high-quality, aspherical optical system provides unsurpassed sharpness and resolution.

LED in HQ - optimal light intensity, homogeneity and colour rendering for each individual examination - Colour temperature: 5,000 K, Colour Rendering Index (CRI) 80, special index for red colours (R9) 35 on a maximum scale of 100. This ensures true tissue colour for the most accurate diagnosis.

Optional Contact Plate with additional magnification - adding the contact plate transforms NC1 in a contact dermoscopy, increasing magnification (9X) plus offering a scale. It combines the speed and ease of use of non-contact dermoscopy with the detail and precision of a contact device.

- 31159 CONTACT PLATE WITH SCALE - D-000.78.115



GIMA XENON HALOGEN SKIN SURFACE MICROSCOPE 10X

- 31187 GIMA XENON HALOGEN DERMATOSCOPE 2.5 V - 10X
- 31183 DERMATOLOGY OIL
- 32203 "C" BATTERIES - blister of 2 pcs.
- 31479 XENON HALOGEN BULB - 2.5V - spare
- 31185 SKIN LESION GAUGE - 21x5 cm

Advanced skin surface microscope offers long-lasting halogen illumination for the true tissue colour and 10X magnification for greater details, allowing accurate diagnoses of pigmented skin lesion. Supplied in a useful bag, with spare autoclavable contact plate with 0-10 mm scale. Latex free.

Available with your logo for min. 2,000 pcs.



TECHNICAL SPECIFICATIONS

Battery: 2x "C" or rechargeable battery (34479) + charger (31542)

Reticle contact plate

Easy to focus, with large focus ring

31185

MD SCOPE VIDEO OTOSCOPE

MD SCOPE VIDEO OTOSCOPE

Instant View

A clear and sharp image can be acquired and displayed instantly on a built-in screen. Just press a single button and wait for 3 seconds.

Real Time Interaction

The medical image can be captured and shared simultaneously with patients. A true improved interaction between the health professionals and the patients.

Electronic medical record

A medical image is automatically generated to support most of the stand-alone health information system. Simply plug the cable into the video-out socket to retrieve the image.



32160



32162

• 32160 ELITE PACK

- MD Scope with
- 1 camera probe 45 mm Ø 5.2 mm
- RCA video cable
- 24 disposable specula
- 2 AA alkaline battery

• 32161 DELUXE ZIPPER PACK - 2 cameras

- MD Scope with
- 2 camera probes 45 (Ø 5.2 mm)/150 (32161)
- 4 camera probes 45 (Ø 5.2 mm)/75/150/300 mm (32162)
- image dongle (32162 only)
- cable set (32176): USB and RCA cable, adaptor for image dongle
- 24 disposable specula
- 2 AA alkaline batteries

Detachable camera modules are designed for different examinations as needed



32165 32167 32168 32169

A video port provides simultaneous image to display on TV/monitor or to download to Mac/PC system



Image dongle



2.4" colour LCD display

Image freeze function

Video out port

320x240 pixels

Lightweight: 218 g

Size: 8x20 cm (2.5"x8")

Battery lifespan: 4 hours

CE
FDA
US pat. n° 8206290

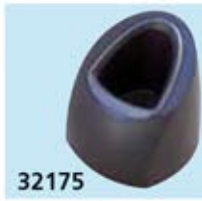

32175

code	ACCESSORIES AND SPARE PARTS
32165	Camera probe 45 x Ø 5.2 mm
32166	Camera probe 47 x Ø 4.2 mm
32167	Long camera probe 75 x Ø 5.2 mm
32168	Flexible camera probe 150 x Ø 5.2 mm
32169	Long flexible camera probe 300 x Ø 5.2 mm
32172	Disposable rigid specula Ø 5.5 mm for 32165 - box of 250
32173	Reusable silicone specula Ø 4.2 mm for 32166 - box of 24
32175	Cradle for video otoscope
32176	Cable set (USB and RCA cable, adaptor)

DIGITAL Wi-Fi & USB VIDEOTOSCOPE + SOFTWARE



32180

Basic software included for acquisition of photos, videos, measurements, google/apple applications

• 32180 MIC Wi-Fi & USB VIDEOTOSCOPE with software Innovative, handheld colour digital Otoscope with Wi-Fi wireless transmission. Small, easy to operate, light and portable. It can be used with all the most popular smartphones, tablets and even with PC.

- Designed in Italy, made in China.
 - 31491 DISPOSABLE MINI EAR SPECULUM Ø 2.5 mm - black - box of 100
 - 31492 DISPOSABLE MINI EAR SPECULUM Ø 4 mm - black - box of 100
- Suitable also Mini Ear Speculum 31485-8, 31495-9 at page 220

TECHNICAL SPECIFICATIONS

Operation system:	Windows (XP and following), Mac (OSX 10.7 and following), iOS, Android
Photo and video resolution:	1.3 MPixels - 1,280x1,024 (MJPEG), 640x480 (MJPEG), 320x240
Frame rate:	15 fps 1280x1024, 30 fps 640x480 320x240
Wi-Fi wireless transmission distance:	up to 5 m
Power consumption:	max 2.5 W
Li-ion battery:	continuous working time - approx. 2 hours, full charging time - approx. 2 hours
Power source:	DC 5.0 V / 1A
Size - weight:	Ø 36x142 mm - 88 g
Camera	
Camera sensor:	CMOS 1/4"
Optical features:	Exposure: Auto, Gamma: Auto, White balance: Auto, Black reference: Auto
Otoscope	
Magnification:	20 X
Focus range:	8-60 mm
Object distance:	1-160 mm
Light source:	4 adjustable white LED
Lens:	high definition microscopy lens
Software interface	Mic-Fi Apps for Android and iOS system and Mic-Fi softwares for PC and MAC

STANDARD ACCESSORIES

Plastic stand	USB AC adapter and cable
Line calibration ruler	Manual (GB, FR, IT, ES, DE)
CD basic software Win (GB, IT, ES, DE, PT, RU, BG, TH, JP, KR) Mac (GB)	

HEINE OMEGA® 500 INDIRECT OPHTHALMOSCOPE

• 31753 HEINE OMEGA 500 XENON-HALOGEN INDIRECT OPHTHALMOSCOPE 6V - C-004.33.539

With mPack pocket battery, plug-in transformer, headband rheostat and 90° angled adapter
- clearer, crisper views: a new illumination system with Xenon Halogen Technology bulb produces less reflexes off the cornea and clear, high resolution bright images of the fundus.

- enhanced variable pupil function: allows for the precise, synchronized selection of observation and illumination optics for any pupil size. It provides stereopsis in pupils ranging from 10 mm to 1 mm.

- fully featured: 3 Spot sizes: Large, Medium and Small. Integrated diffused light filter.

3 Integrated Filters: Red-free, Cobalt Blue, and Yellow.

- Omega headband comfort: articulating Rear Hinge provides vertical adjustment of the rear band of the headband for individual placement.

• 31756 HEINE OMEGA 500 UNPLUGGED LED™ INDIRECT OPHTHALMOSCOPE 6V - C-008.33.535
With mPack battery integrated in headband, plug-in transformer, headband rheostat and 90° angled adapter. Same feature as 31753 with in addition:

- LED technology: absolutely homogeneous, uniform illumination, up to 100% brighter compared with XHL (Xenon technology)

- rechargeable battery integrated on the headband

- mPack rechargeable battery: charging time 2 hours, operating time 8 hours

• 31757 HEINE OMEGA 500 LED™ INDIRECT OPHTHALMOSCOPE WITH DV1 DIGITAL VIDEO CAMERA - C-008.33.561
with mPack UNPLUGGED with plug-in transformer

1280 x 960 imaging: capable of capturing High-Resolution video

- simple operation: digital imaging without any additional adjustments.

- comfortable and balanced fit: headband perfectly distributes the low weight of the camera and optics

- integrated focus adjustment

- interface and software: will plug into any laptop or computer via USB 2.0 interface. Supplied with software program for video recording and image capture. For more information see <http://dv1.heine.com>

- cable-free power source: system with mPack UNPLUGGED rechargeable battery.



5 YEARS WARRANTY

Light weight only 450g



31757

WELCH ALLYN MACROVIEW™ OTOSCOPE

• 32100 MACROVIEW™ HEAD - 23810

• 32101 LITHIUM ION HANDLE WITH AC CHARGING MODULE 3.5 V - 71902

This next-generation otoscope features advanced optics that increase magnification while giving you a nearly full view of the tympanic membrane - virtually eliminating the need for panning. With its easy-to-focus eyepiece, MacroView allows for enhanced visualization to help see past wax, locate fluid behind the eardrum, and even perform exams without your glasses.

- twice the field of view

- 30% greater magnification than a traditional otoscope

- nearly a full view of the tympanic membrane

- better clarity and definition of landmarks

- ability to adjust focus for variable ear canal lengths or farsighted eyes

• 32106 KLEENSPEC® ADULT DISPOSABLE EAR SPECULA

4.25 mm - box of 850 pcs - 52434-UB

• 32105 KLEENSPEC® PEDIATRIC DISPOSABLE EAR SPECULA

2.75 mm - box of 850 pcs - 52432-UB

• 32135 SPARE HALOGEN BULB - 3.5 V - 06500 U

Adjustable focus wheel allows to accommodate for variable ear canal lengths and farsighted eyes a full view of the tympanic membrane

Tip grip ensures ear specula is fastened securely and easily disposed

Default focus position (the dot and the line)

Advanced optics give you 2X the field of view and 30% greater magnification than a conventional otoscope



32100

Insufflation port for pneumatic otoscopy

Welch Allyn

Lithium-ion handle with AC charger module compatible with all Welch Allyn instrument handles 3.5 V



32101

WELCH ALLYN PANOPTIC™ OPHTHALMOSCOPE

• 32110 PANOPTIC OPHTHALMOSCOPE HEAD - 11810

• 32101 LITHIUM ION HANDLE WITH AC CHARGING MODULE 3.5 V - 71902

PanOptic is a breakthrough concept in ophthalmoscopy. Thanks to an innovative, optical design known as Axial PointSource™ Optics, it will greatly enhance your fundoscopic examinations.

- fast easy entry into small, undilated pupils

- 5X larger field of view than you see with standard ophthalmoscopes in an undilated eye

- 25° field of view versus the 5° field of view of standard ophthalmoscopy

- a 26% increase in magnification, making it easier to see retinal details

- greater distance between practitioner and patient means greater comfort for all

• 32127 SPARE HALOGEN BULB - 3800 U

Patented Axial PointSource™ Optics: makes it easy to enter undilated pupils, and provides a 25° field of view, resulting in a view of the fundus 5 X greater than with a standard ophthalmoscope in an undilated eye

Halogen HPX™ Lamp: provides whiter, brighter light

Glare Extinguishment System: prevents interference from unwanted glare and reflections

Welch Allyn 3.5 V Power Sources: compatible with any standard 3.5 V power source including: desk charger handles, convertible battery handles, wall transformers and the Lithium Ion Power Handle



Patient Eyecup: allows proper viewing distance, provides image stability, serves as a pivoting point for panning around the retina, helps with orientation, and screens out ambient light. The eyecup is cleanable and reusable

PanOptic Soft Grip: ergonomically designed for maximum comfort, balance, and access to controls.

Dynamic Focusing Wheel: adjusts the focus in a continuous, smooth action for more precise control and optimum view. Available focusing range is -20 to +20 diopters

Aperture Dial: allows you to select micro, small, and large spot sizes. Also includes red-free filter and slit aperture, half-moon aperture for corneal exams

FIELD OF VIEW



Larger view of the fundus

5X



HEINE ORIGINAL BULBS

HEINE BULBS	HEINE ref.	code	Compatible with following HEINE products
	035	31769	Transilluminator Finoff alpha [®] F.O. and F.O. SP Laryngoscopes - Sanalon handle Glauco-test
	037	31771	K100 and Beta [®] 100, Beta [®] 100 vet otoscopes Laryngeal mirrors F.O. mini 2000 otoscope Alpha [®] and Alpha F.O. otoscopes Mini/mini 3000/Alpha/Beta tongue holders
	038	31773	Miroflex ophthalmoscope HFR2 spot retinoscope Delta [®] 10 dermatoscope
	041	31774	Fibrilux mini otoscope Mini 2000 combilamp Mini 2000 cliplamp Mini 1000 cliplamp
	042	31780	Alpha [®] ophthalmoscope Mini 2000 ophthalmoscope Alpha [®] Focalux Mini Miroflex ophthalmoscope Mini 2000 Focalux
	056	31770	Minilux otoscope Mini 2000 otoscope
	057	31785	Mini 2000, Mini 3000 laryngeal mirrors
	069	31781	Beta [®] 200, 200 M2, 200S ophthalmoscopes - XHL 2.5 V
	077	31772	Beta [®] 200, 200 VET, 400; K 180 otoscopes Lambda 100 retinometer Delta [®] 10 plus dermatoscope
	084	31782	K180 [®] ophthalmoscope - 2.5 V
	105	31776	Mini 3000 F.O. otoscope
	106	31777	Mini 3000 ophthalmoscope
	107	31778	Mini 3000 combilamp and cliplamp - XHL 2.5 V
	109	31779	Mini 3000 dermatoscope
	110	31775	Mini 3000 otoscope
	070	31783	Beta 200, 200 M2, 200S ophthalmoscopes - XHL 3.5V
	078	31784	Beta 200, 200 Vet, K180 otoscopes lambda 100 retinometer otoscopes - XHL 3.5V

WELCH ALLYN BULBS

WELCH ALLYN BULBS	W. A. ref.	code	Compatible with following WELCH ALLYN products
	00200-U	32120	Anoscopes: 38800, 380, 385, 395 Illuminators: 41000, 26030 Old products: 235, 77900, 26000, 20100, 21600, 42700, 40510
	03000-U	32123	Ophthalmalmo: 11710, strabismoscope: 12400, episcope: 47300 Old ophthalmalmo: 11600, 11605, 11610 Retinoscope: 18000
	03100-U	32124	Otoscopes: 25020, 21700, 20200 Handle: 73500, holder: 28100 illuminators: 27000, 27050, 26530, 41100, 43300 Old otoscopes: 25000, 25200, 20000
	03300-U	32125	Ophthalmalmo: 11511-11500
	03400-U	32126	Otoscopes: 24011-24020-24000-24031-21110/1 Handle: 73550, illuminators: 27200-27250-41110
	03800-U	32127	Pan optic: 11810-11820-11800
	04100-U	32128	Exam light: 48400-48410
	04200-U	32129	Exam light: 48600, 48610-48625-48635, 48700
	04400-U	32130	Ophthalmoscopes: 11400-11411-11470-11475
	04700-U	32131	Laryngo: 680, 690, 692 (size 1-2) Old laryngo: 634, 664, 674, 684, 694 (check size)
	04800-U	32132	Laryngo: 680 (size 2-4), 690, 692 (size 3-4) Old laryngo: 634, 640, 664, 674, 684, 694 (check size)
	04900-U	32133	Ophthalmalmo: 11720, 11730, 11735, 11620, 11630
	06000-U	32134	Laryngo handles: 60813, 60814, 60713, 60815, 60803, 60804
	06500-U	32135	Macroview otoscope: 23810, 23820
	07800-U	32136	Handle: 73211, 73210, 78000, 73200

RIESTER ORIGINAL BULBS

RIESTER BULBS	RIESTER ref.	code	Bulb	Compatible with following RIESTER products
	10421	31850	Vacuum 2.7 V	Otoscope uni [®] /speculight
	10424	31851	Vacuum 2.5 V	May-ophthalmoscope uni [®]
	10487	31825	XL 3.5 V xenon	Otoscope ri-scope [®] L1
	10488	31852	Vacuum 2.7 V	Pen-scope [®] and e-scope [®] otoscope
	10489	31560	HL 2.5 V	Otoscope pen-scope [®] / ri-scope [®] L1 and e-scope [®]
	10590	31853	HL 2.5 V	Otoscope uni [®]
	10600	31854	XL 2.5 V	Otoscope ri-mini [®] , ri-scope [®] L2/L3 and e-scope [®]
	10605	31562	HL 2.5 V	Ophthalmoscope ri-mini/ ri-scope [®] L1, L2, L3, e-scope [®] , ri-derma [®]
	10607	31855	XL 3.5 V	Ri-scope [®] otoscope L2, L3
	10608	31826	XL 3.5 V	Ri-scope [®] ophthalmoscope L1, L2, L3
	14041	31561	LED 3.7 V	E-scope F.O otoscope
	14051	31563	LED 3.7 V	E-scope ophthalmoscopes



COMPATIBLE GERMAN BULBS

GIMA BULBS	code	Compatible with the following products
LARYNGOSCOPE BULBS - MADE IN GERMANY		
	34324	Gima, Riester, And, Kawe, Timesco Truphatek and most of conventional laryngoscopes in the market (generally used for blades N° 00, 0, 1)
	34325	Gima, Riester, And, Kawe, Truphatek, Timesco and most of conventional laryngoscopes in the market (generally used for blades N° 2, 3, 4)
	34485	Gima, And, Kawe and most of F.O. laryngoscopes in the market. Compatible for products that use Heine Bulb # 035
OTOSCOPE-OPHTHALMOSCOPE BULBS - MADE IN FRANCE-GERMANY		
	31795	Heine mini 3000 otoscopes
	31796	Heine mini 3000 F.O. otoscopes
	31449	Parker otoscopes and some otoscopes of Riester, Timesco and Kawe
	31446	Parker ophthalmoscope Parker diagnostic sets
	31478	Gimalux otoscopes, Kawe and Riester mini otoscopes Compatible for products that use Heine bulb #037
	31479	Parker halogen ophthalmoscope
	31428	Gima Xenon - halogen diagnostic sets - ophthalmoscope
OTO-OPHTHALMO-DERMATOSCOPE BULBS - OTHER COUNTRIES		
	31188	Gima dermatoscope Compatible for products that use Heine Bulb #038
	31427	Gima Xenon - halogen diagnostic sets - otoscope

HEINE MINI 3000® XHL AND LED^{HQ} OTO AND OPHTHALMOSCOPE



31680
31684
31676
31678

31681
31685
31687

31682
31683



5 YEARS WARRANTY



31678



31686
31688



Ophthalmoscope with 5 different apertures
 - Large spot for normal fundus examinations.
 - Small spot to access small pupils.
 - Fixation star for determination of central or eccentric fixation. Especially suited for examining children.
 - Hemispot for reduced reflection with small pupils.
 - Red-free filter for contrast-enhancement when assessing fine vascular disorders



31689, 31696

MINI 3000 F.O. XENON OTOSCOPES

Powerful pocket otoscope in a unique compact design.
 - Xenon halogen bulbs for bright illumination and accurate colour rendering.
 - 20,000 on/off switch cycles guaranteed.
 - distal Fiber Optic (F.O.) illumination: Reflex-free illumination of tympanum and ear canal.
 - viewing window with 3X magnification and optimized casing surface for razor-sharp images and minimal reflection. Swivelling viewing window built into instrument.
 - pneumatic testing of the tympanum mobility by using the insufflation port and an optional connector.
 - attachment clip with integrated on/off switch.
 - replaceable batteries: size AA or optional rechargeable battery (31693) with mini NT table charger (31692).
 - 2-piece handle and head. Easy to maintain, flexible. Compatible with other handles.

MINI 3000 F.O. LED^{HQ} OTOSCOPES

All features of F.O. Xenon otoscopes with the addition of:
 - maintenance-free, no need to ever change the LED.
 - LED thermal management for a consistent light output throughout the whole working life.
 - High-performance-LED: bright and absolutely homogeneous illumination with excellent colour rendering - colour temperature 4,000°K, colour rendering index >95, and >90 rendering index of the colour red.
 - twice as bright as Xenon Halogen instruments.
 - exclusive Battery Performance Indicator
 - exclusive fade-out function reduces illumination intensity with battery level to let you know when to replace.
 - operation time up to 10 hours

MINI 3000 OTOSCOPES 2.5 V				
	BLACK		BLUE	
	code	HEINE code	code	HEINE code
Standard	31680	D-001.70.210	31681	D-001.70.210
F.O. Xenon	31684	D-001.70.110	31685	D-001.70.110
F.O. LED ^{HQ}	31676	D-008.70.110	31677	D-008.70.110
MINI 3000 OTOSCOPE 2.5 V - RECHARGEABLE HANDLE**				
F.O. Xenon	31682	D-001.70.301	-	-
F.O. LED ^{HQ}	31683	D-008.70.301	-	-
MINI 3000 OTOSCOPE 2.5 V - hard case				
F.O. LED ^{HQ}	31678	D-885.20.021	-	-

Above otoscopes are supplied in a box with 5 disposable speculum Ø 4 mm and 5 Ø 2.5 mm

Supplied in hard case with 5 disposable speculum Ø 4 mm, 5 Ø 2.5 and 4 reusable speculum (Ø 2.4, 3, 4, 5 mm)

31503
Dispenser of 250 pcs.



31516



code	HEINE DISPOSABLE MINI EAR SPECULUM*	Minimum order
31501	HEINE dispenser for mini speculum - empty	-
31502	HEINE disposable Allspec® speculum Ø 2.5 mm - grey	dispenser of 250
31503	HEINE disposable Allspec® speculum Ø 4 mm - grey	dispenser of 250
31515	HEINE disposable Allspec® speculum Ø 2.5 mm - grey	box of 1000
31516	HEINE disposable Allspec® speculum Ø 4 mm - grey	box of 1000

*Compatible with Heine Mini 2000/3000, K180, Beta 200, Beta 400

MINI 3000 XENON OPHTHALMOSCOPES

Modern pocket ophthalmoscope with fixation star aperture. Excellent optics and best colour rendering in minimum size.
 - XHL Xenon Halogen Technology. Concentrated bright light for perfect illumination, a brilliant image and accurate colour rendering.
 - the HEINE optics produce crisp, clear images of the whole area under examination and minimize the reflections.
 - 5 different apertures. A full-function instrument incl. fixation star.
 - grey filter for light sensitive patients.
 - range of lenses: 18 lenses from -20 D to +20 D.
 - easy workflow, because ophthalmoscopy is possible without dilation of the pupils.
 - attachment clip with integrated on/off switch.
 - replaceable batteries. Size AA or optional rechargeable battery (31693) with mini NT table charger (31692).

MINI 3000 LED^{HQ} OPHTHALMOSCOPES

All features of Xenon ophthalmoscope with the addition of:
 - maintenance-free, no need to ever replace the LED.
 - LED thermal management for a consistent light output throughout the whole working life.
 - high-performance-LED: bright and absolutely homogeneous illumination with an excellent colour rendering - colour temperature 4,000°K, colour rendering index >95, and >90 rendering index of the colour red.
 - exclusive battery performance indicator
 - exclusive fade-out function reduces illumination intensity with battery level to let you know when to replace.
 - operation time up to 10 hours.

MINI 3000 OPHTHALMOSCOPES 2.5 V				
	BLACK		BLUE	
	code	HEINE code	code	HEINE code
Xenon	31686	D-001.71.120	31687	D 001.71.120
LED ^{HQ}	31688	D-008.71.120	-	-
MINI 3000 OPHTHALMOSCOPES 2.5 V - RECHARGEABLE HANDLE**				
F.O. Xenon	31694	D-001.71.200	-	-
F.O. LED ^{HQ}	31695	D-008.71.200	-	-
MINI 3000 OTO-OPHTHALMO SET - hard case				
Xenon Set	31689	D-873.11.021	-	-
LED ^{HQ} Set	31696	D-886.11.021	-	-

Both set (Xenon or LED) include one F.O. otoscope head, one ophthalmoscope head, 2 handles, 4 reusable specula (Ø 2.4, 3, 4, 5 mm), 5 disposable specula Ø 4 mm and 5 Ø 2.5 mm in hard case.

NiMH rechargeable battery with bottom insert for Mini 3000 handles.

31693



31692

code	HEINE code	CHARGER AND ACCESSORIES
31691	D-000.80.101	MINI 3000 connector for pneumatic test
31692	X-001.99.484	HEINE MINI 3000 NT charger
31693	X-001.99.487 + X-001.99.488	BATTERY + BASE

**Need Heine Mini 3000 NT charger (31692)

SIGMA F.O. DIAGNOSTIC SETS

SIGMA otoscopes and ophthalmoscopes are high quality pocket diagnostic instruments designed for professional use in ENT and ophthalmology. Light weight and manufactured from impact resistant re-enforced plastic.

Supplied in deluxe rigid plastic cases or pouch (31524) with 14 disposable specula (7 with Ø 2.5 mm, 7 with Ø 4 mm).

- 31524 SIGMA F.O. OTOSCOPE 2.5 V - pouch - black
- 31523 SIGMA F.O. OTOSCOPE 2.5 V - pouch - blue
- 31525 SIGMA F.O. OTOSCOPE 2.5 V - case - black
- 31526 SIGMA F.O. LED OTOSCOPE 2.5 V - case - black
- 31518 SIGMA F.O. LED OTOSCOPE 2.5 V - case - blue

Manufactured with high quality materials and top-notch workmanship ensures excellent reliability in every examination.

Battery life with Led bulb (31526) 6 time longer than with traditional bulb

- distal fibre optic illumination with super bright Xenon/Halogen light or LED light.
- swivel type window with 3X magnification lens for sharp images and minimal reflection
- insufflation port for pneumatic testing of tympanic mobility.

Connector port (code 31532) and insufflation bulb (code 31500) should be ordered separately.

- 31527 SIGMA F.O. OPHTHALMOSCOPE 2.5 V - case - black
- 31529 SIGMA LED OPHTHALMOSCOPE 2.5 V - LED light 85,000 LUX - bulb estimated life 50,000 hours - case - black

Top quality ophthalmoscope with 5 different apertures for almost all ophthalmic examinations. High quality optics in mini format makes this instrument ideal for house calls and rounds.

- enhanced xenon/halogen super bright light
- 5 different apertures

Large spot: for normal funduscopy

Small spot: for reduced reflection with small pupils

Semi circle: for reduced reflection with small pupils

Fixation star: for determination of central or eccentric fixation, suitable for examining children

Red-free filter: for contrast-enhancement when assessing fine vascular disorders

- range of lenses from -20 D to +20 D

- 31533 SIGMA F.O. OTO-OPHTHALMOSCOPE SET 2.5 V - case with 1 handle - black
 - 31528 SIGMA F.O. OTO-OPHTHALMOSCOPE DELUXE SET 2.5 V - case with 2 handles - black
 - 31534 SIGMA F.O. LED OTO-OPHTHALMOSCOPE DELUXE SET 2.5 V - case with 2 handles
- Oto-ophthalmo sets are supplied with oto and opthalmo head, 1 handle (31533) or 2 handles (31528, 31534) and 14 disposable speculum (7x2.5 and 7x4 mm)
- 34485 OTOSCOPE BULB - xenon - halogen 2.5 V
 - 31531 OPHTHALMOSCOPE BULB - xenon - halogen 2.5 V
 - 31532 PNEUMATIC CONNECTOR PORT
 - 31500 INSUFFLATION BULB



31524



Colour coded 18 lenses for excellent resolution

+	1	2	3	4	6	8	10	15	20
-	1	2	3	4	6	8	10	15	20

LED features

- colour temperature: 5,000°K
- real colours definition
- bulb estimated life 50,000 hours
- CRI > 80
- 85,000 LUX

31527

31524,
31525

FIBRE OPTIC
OR F.O. LED

31518

31527

31533

31528, 31534

HEINE BETA® 200 RETINOSCOPE

- 31745 HEINE BETA 200 RETINOSCOPE - slit - 2.5 V - C-034.10.118

With ParaStop® for finding the neutralization point (US pat.

5,859,687): precise, easy selection of a parallel beam

- dustproof: maintenance free

- single control for vergence and rotation: comfortable operation

- integrated polarisation filter: eliminates stray light and internal reflexes for a brighter pupilling reflex

- streak or spot retinoscope: simply by changing the bulb

- XHL (xenon halogen technology): bright, white light. Bright fundus reflex, easy recognition of neutralization point

- ergonomic shape: protects the examiner's orbit from stray light



5 YEARS
WARRANTY

E-SCOPE®: RIESTER OTO-OPHTHALMOSCOPES



INNOVATIVE LED 3.7 V ILLUMINATION:
 - real colour 5,500K white light
 - long life LED bulbs: up to 20,000 hours
 - low battery consumption: up to 50 hours operation through IPC (Integrated Power converter). It converts the voltage of AA batteries into the optimum voltage required for LED

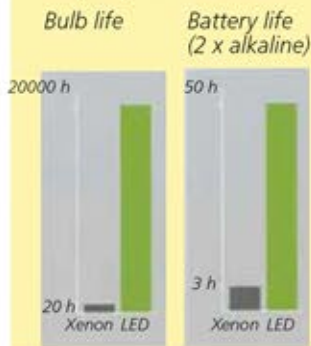

Riester
 Made in Germany

- 31550 E-SCOPE® OTOSCOPE - XENON 2.5V - black in pouch
 - 31552 E-SCOPE® F.O. OTOSCOPE - LED 3.7V - white in rigid case
 E-scope otoscope with direct Xenon illumination or F.O. LED.
 - Sealing precision optics pivoting to both sides with triple magnification for superior view
 - Suitable for performance of pneumatic tests (supplied without connector and insufflator)
 - 31556 E-SCOPE® OPHTHALMOSCOPE - XENON 2.5 V - black - in rigid case
 - 31557 E-SCOPE® OPHTHALMOSCOPE - F.O. - LED 3.7 V - white - in rigid case
- E-scope ophthalmoscopes are available with Xenon or LED illumination.
- with 2.5V Xenon illumination and with innovative 3.7V LED illumination for higher-contrast and more efficient diagnosis
 - dioptre disc with 18 corrective lenses ($\pm 1, 2, 3, 4, 6, 8, 10, 15, 20$)
 - easy-to-use aperture wheel with six apertures (fixation star, large circle, small circle, red free filter, blue filter, semi circle)
 - high performance optics with aspherical condenser
 - spectacle protection
 - parallel optical path



- 31558 E-SCOPE® DIAGNOSTIC KIT
 Oto-ophthalmoscope set, LED 3.7V, white colour, in rigid case.
- 31560 E-SCOPE® OTOSCOPE - XENON 2.5 V BULB
- 31561 E-SCOPE® OTOSCOPE - LED 3.7 V BULB
- 31562 E-SCOPE® OPHTHALMOSCOPE - XENON 2.5 V BULB
- 31563 E-SCOPE® OPHTHALMOSCOPE - LED 3.7 V BULB
- 31817 RI-SCOPE® EAR SPECULUM Ø 2.5 mm - autoclavable
- 31819 RI-SCOPE® EAR SPECULUM Ø 4 mm - autoclavable

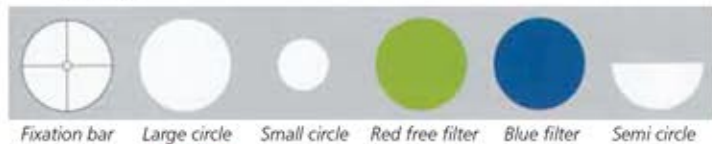

LUXAMED AURIS LED OTOSCOPES - MADE IN GERMANY



- 31570 LUXAMED AURIS LED 2.5V OTOSCOPE - black
 - 31571 LUXAMED AURIS LED 2.5V OTOSCOPE - blue
 - 31572 LUXAMED AURIS LED 3.7V USB OTOSCOPE - black
- Innovative otoscopes that combine best handicraft production with selected materials with the most modern technology. Two-components handle (aluminium/fibre-glass reinforced) with electronic ON/OFF switch.

- Features:
- LED-Ring illumination with 6 LEDs (concentric), no fibre optic, field of vision is not restricted, with the theoretical failure of a single LED, the functionality is not affected (patent DE202013104278U1)
 - dimmer
 - automatic switchoff after 3 minutes
 - approx. 100,000 hours life expectancy of LEDs
 - approx. 10,000 Lux intensity of illumination
 - approx. 4,000 K colour temperature
 - pivoting 3-fold magnifying glass with locking function
 - insufflation port for pneumatic test.

Supplied with 2xAAA alkaline batteries (31570/1) or lithium-ion rechargeable battery 3.7V (31572) 20 disposable ear funnels (10x2.5 mm and 10x4.0 mm) and manual (GB, IT, DE). See page 219-220 for compatible ear speculum.



HEINE K100 HALOGEN OTOSCOPE HEINE K180 OTO-OPHTHALMO



5 YEARS WARRANTY



31720

- 31720 HEINE K 100 HALOGEN OTOSCOPE - 2.5 V - B-245.10.118 Otoscope with BETA battery 2.5 V handle with rheostat, high-impact polycarbonate housing and 3 reusable specula (Ø 3.5, 4.5, 5.5) in nylon pouch. XHL (Xenon Halogen Technology), extremely bright, white light. Acrylic viewing window with 3X magnification, insufflation port for tympanic test.
- 31771 HEINE 037 OTOSCOPE BULB 2.5 V - spare - X-001.88.037



31740

- 31740 HEINE K180 - F.O. OTO-OPHTHALMO SET - 2.5 V - A-279.10.118 Otoscope and ophthalmoscope K180 with BETA battery 2.5 V handle and a set of single use specula. Supplied in hard case.
- 31782 HEINE 084 OPHTHALMO BULB 2.5 V - spare - X-001.88.084
- 31772 HEINE 077 OTOSCOPE BULB - spare - X-001.88.077
- 31741 HEINE K180 OPHTHALMOSCOPE - 2.5 V C-182.10.118 28 lenses from -35D to +40D supplied in pouch

HEINE BETA 200 F.O. OTOSCOPES



31725
31726
31728

Large, scratch-resistant glass viewing window with 3x magnification

34449



BETA 200, BETA 400 OTOSCOPE HEAD

Distal fiber optic (F.O.) illumination with XHL xenon halogen technology
Airtight window seal for reliable test of tympanic mobility



Handle with charge status display

31728

- 31725 HEINE BETA 200 F.O. OTOSCOPE - 2.5V - B-141.10.118 F.O. Otoscope with BETA battery 2.5V handle with rheostat, a set of single use specula, a set of reusable specula and a spare bulb. Supplied in hard case. Solid all metal construction, a quality instrument with fibre optic illumination.
- 31772 HEINE 077 OTOSCOPE BULB - spare - X-001.88.077
- 31726 HEINE BETA 200 F.O. OTOSCOPE - 3.5V Li-ion L - B-141.29.420 Same as code 31725 but with 3.5V rechargeable handle with charging status display, Li-ion battery and charging station (34449).
- 31784 HEINE 078 OTOSCOPE BULB - X-002.88.078

- 31728 HEINE BETA 400 LED F.O. OTOSCOPE - B-143.24.420 Exclusive 4.2X magnification. LED in HQ with continuous brightness control. All metal housing and scratch resistant glass lenses. Colour temperature: 3,500 K. Colour rendering index (CRI) >97. Exceptional depth of field, provides sharp spatial image. LED otoscope with rechargeable handle supplied with 4 reusable speculum, 5 of both All Spec disposable speculum 2.5 and 4 mm Ø in a case with NT4 table charger (34374).

HEINE BETA 200 AND 200S OPHTHALMOSCOPES



31730

6 standard diaphragms: slit, fixation star with polar co-ordinates, cobalt blue filter, large spot, small spot, hemi spot

6 diaphragms with green filter

+ in 1 D steps 1 - 10 15 20 40 D
- in 1 D steps 1 - 10 15 20 25 35 D

- 31730 HEINE BETA 200 HALOGEN OPHTHALMOSCOPE - 2.5 V - C-144.10.118 The unique aspherical optic system eliminates corneal and iris reflexes. The illuminated area of the retina remains fully visible even in case of small pupil (bright light). BETA 200 has 6 diaphragms with separately "green filter". It is recommended for small or expanded pupils; suitable for slit or fluorescent ophthalmoscopy as well as for fixation test. Range -35D to +40D. Supplied in hard case with replacement bulb.
- 31731 HEINE BETA 200 F.O. OPHTHALMOSCOPE - 3.5 V Li-ion - C-144.27.388 Same as 31730 but with USB rechargeable handle for mains socket and Li-ion batteries.
- 31783 HEINE 070 OPHTHALMOSCOPE BULB 3,5 V - X-002.88.070



31730

- 31735 HEINE BETA 200S OPHTHALMOSCOPE - 2.5 V - C-261.10.118
- 31781 HEINE 069 OPHTHALMO BULB - 2.5 V - spare - X-001.88.069
- 31737 HEINE BETA 200S LED OPHTHALMO - 3.5 V with USB rechargeable handle - C-261.28.388

- Superior aspherical optics and 74 single-diopter steps
- optical system: corneal and iris reflexes are eliminated. A full view is guaranteed even with small pupils.
- XHL (Xenon Halogen Technology) or LED: bright, white light.
- recessed, multi-coated viewing window: avoids stray light.
- optics mounted on precision metal chassis.
- ergonomic shape: instrument fits the orbita comfortably in any position.
- 7 apertures with separate red-free filter:
- lens range: perfect focus even with high refractive errors.
- exact colour rendering

Cobalt blue filter, fixation star with polar co-ordinates, large spot, small spot, pinhole, slit, hemisport

With red-free filter: Cobalt blue filter, fixation star with polar coordinates, large spot, small spot, pinhole, slit, hemisport

74 single diopters steps
+ in 1 D steps: +1 through +38 D
- in 1 D steps: -1 through -36 D



VISIO 2000 F.O., XENON OTO, OPHTHALMO, ENT SETS - 3.5 V

Professional diagnostic sets with fiber optic illumination system, Xenon light 3.5 V, rheostat to adjust the intensity of light. Powered by rechargeable Li-ion batteries.

All products are made of impact resistant re-inforced plastic and durable easy locking system for hospital long term use. Supplied in deluxe case, should be used with charging station 31542 and Li-ion rechargeable battery (31541). Only plug-in set (31537) as direct AC connection and need battery 31547.

- 31535 VISIO 2000 F.O. XENON OTOSCOPE - 3.5 V
- 31536 VISIO 2000 F.O. XENON OPHTHALMOSCOPE - 3.5 V
- 31537 VISIO 2000 F.O. XENON OTO-OPHTHALMOSCOPE PLUG-IN SET - 3.5 V - 2 pin plug
- 31538 VISIO 2000 F.O. XENON OTO-OPHTHALMOSCOPE - 3.5 V
- 31539 VISIO 2000 F.O. XENON DIAGNOSTIC SET - 3.5 V
- 31428 OPHTHALMOSCOPE BULB - spare
- 31544 OTOSCOPE BULB - spare
- 31541 LI-ION RECHARGEABLE BATTERY
- 31547 LI-ION RECHARGEABLE BATTERY 3.5 V PLUG-IN HANDLE for 31537

- 31542 ZOOM CHARGING STATION
Supplied with EU 2 pin, UK and US plug

Swivel type window with 3X magnification for sharp images and minimal reflection



Distal F.O. illumination with super bright xenon light

Durable easy locking system

Rheostat

6 apertures to select from:

- Micro spot aperture
- Small aperture
- Large aperture
- Fixation aperture
- Slit
- Red-free filter

Enhanced Xenon super bright light



0	1	2	3	4	5	6	7	8	9	10	12	15	20	40
	1	2	3	4	5	6	7	8	9	10	15	20	25	

Colour coded 28 lenses for perfect examination (GREEN for +, RED for -)



31542



31535

F.O. Xenon otoscope set 3.5 V
F.O. otoscope head, battery handle with bayonet lock, 1 set of 5 reusable eartips (2.5, 3.5, 4.5, 5.5 & 9.0 mm), tube of 14 disposable eartips (2.5 & 4.0 mm), spare bulb, in a rigid case.
F.O. Xenon ophthalmoscope set 3.5 V
F.O. ophthalmoscope head, battery handle with bayonet lock, spare bulb, in a rigid case.



31537

F.O. Xenon oto/ophthalmo plug-in set 3.5 V
F.O. otoscope head, F.O. ophthalmoscope head, one battery handle with bayonet lock and plug-in, 1 set of 5 reusable eartips (2.5, 3.5, 4.5, 5.5 & 9.0 mm), tube of 14 disposable eartips (2.5 & 4.0 mm), spare oto and ophthalmoscope bulbs, rechargeable Li-ion battery in a rigid case.



Plug-in handle



31538

F.O. Xenon oto/ophthalmo set 3.5 V
F.O. otoscope head, F.O. ophthalmoscope head, two battery handles with bayonet lock, nasal illuminator with F.O. light, 1 set of 5 reusable eartips (2.5, 3.5, 4.5, 5.5 & 9.0 mm), tube of 14 disposable eartips (2.5 & 4.0 mm), spare oto and ophthalmoscope bulbs in a rigid case.



31539

F.O. Xenon ENT diagnostic set 3.5 V
F.O. otoscope head, F.O. ophthalmoscope head, battery handle with bayonet lock, nasal illuminator with F.O. light, curved illuminator with bulb, plain mirror 20.0 mm, plastic tongue depressor, 1 set of 5 reusable eartips (2.5, 3.5, 4.5, 5.5 & 9.0 mm) tube of 14 disposable eartips (2.5 & 4.0 mm), spare oto and ophthalmoscope bulbs, in a rigid case.

GIMA VISIO 2000 WALL DIAGNOSTIC STATION - 3.5 V

- 31545 GIMA WALL DIAGNOSTIC STATION - 3.5 V
- Perfect solution for everyday clinical and hospital life. The unit has a centralized electrical supply, eliminating the need for conventional or rechargeable batteries. Wall station is equipped with two handles one with Visio 2000 otoscope Xenon light head and one with Visio 2000 ophthalmoscope Xenon light head.
- Main features:
- automatic ON/OFF switching of the handles, the instrument turns off automatically once the handle is placed in the cradle
 - non-slip ergonomic handle design
 - handle with a brightness control mechanism for light adjustment
 - spiral cable enables working at 3 metres
- Power: 115-230 V, 50-60 Hz. Disposable ear speculum see page 220



31545

RI-FORMER® THE MODULAR DIAGNOSTIC STATION 3.5V



RI-FORMER MODULAR DIAGNOSTIC STATION

The modular diagnostic station can be individually combined according to requirements and the room situation, it is variably extendable to the right and the left.

The basic ri-former® module is available with one handle and can be supplemented with up to 4 further handle modules.

- 3.5V Xenon or LED illumination creates lighting conditions similar to daylight
- optimum electronic efficiency using an adjustable dimmer
- constant output voltage independent from the mains supply prolongs the service life of the lamps and guarantees optimum light intensity
- automatic switching on/off of handles when removing or replacing them in the handle unit saves energy and increases the service life of the lamps
- non-slip, ergonomically designed handles with rheostat: infinitely variable regulation of brightness as well as manual switching on/off possible on the handle
- spiral cord expandable up to 3 m
- developed and manufactured in Germany.



MODULAR DIAGNOSTIC STATION - XENON	
31800	Ri-Former Diagnostic station 3.5-230V* 50/60 Hz-standard (include 2 handle oto and ophthalmo head, ear specula dispenser, clock)
31805	Ri-Former Diagnostic station 3.5-230V* 50/60 Hz-large (include 31800 + sphygmomanometer) *available on request 120V - 50/60 Hz
MODULAR DIAGNOSTIC STATION - LED	
31801	Ri-Former Diagnostic station 3.5-230V* 50/60 Hz-standard (include 2 handle, LED oto and ophthalmo head, ear specula dispenser, clock)
31806	Ri-Former Diagnostic station 3.5-230V* 50/60 Hz-large (include 31801 + sphygmomanometer) *available on request 120V - 50/60 Hz
RI-FORMER MODULES AND HEADS	
31809	Basic diagnostic station 1 handle 3.5 - 230V* 50/60 Hz
31810	Extension module 1 handle
31811	Ri-scope L2 otoscope head - Led 3.5V
31812	Ri-scope L1 otoscope head - Xenon 3.5V
31813	Ri-scope L1 ophthalmoscope head - Xenon 3.5V
31814	Ri-scope retinoscope head - Xenon 3.5V
31815	Ri-scope dermatoscope head - Led 3.5V
31817	Ri-scope L1, L2 ear speculum Ø 2.5 mm** - autoclavable 134°C
31819	Ri-scope L1, L2 ear speculum Ø 4 mm** - autoclavable 134°C
31820	Ri-spec ear specula dispenser - specula not included
31822	Sphygmomanometer with basket
31823	Ri-thermo N infrared thermometer with 40 covers
31824	Probe cover for 31823 - box of 100 - spare
31825	Xenon L1 otoscope bulb 3.5V - spare
31826	Xenon ophthalmoscope L1, L2, L3 bulb 3.5V - spare

*Available on request 120V - 50/60 Hz

**box of 10



RI-SCOPE® L: LED + Li-ion BATTERIES



Riester



31830

LED illumination: bright, white light with a nearly unlimited lifetime! With its monochromatic white light (4,000° Kelvin) the lamp in the ri-scope®L provides cold light and true-colour. CRI > 90. Lamps with LED technology have a lifetime of at least 10,000 hours (compared to 20-30 hours with halogen and Xenon lamps) and are extremely energy-efficient.

Li-ion batteries - greatest power in the smallest space! Considerably higher charging capacity, longer lifetime, lightweight, these are the big advantages of Li-ions batteries; wich provide sustained high performance for up to 1200 charging cycles. LEDs powered by lithium batteries can burn for up to 50 hours.

• 31830 RI-SCOPE L2 LED OTOSCOPE - 3,5 V

The newest generation ri-scope®L otoscopes with optical glass and reduced reflection combines excellent optical properties and unparalleled performance with the reliability and efficiency of LED/lithium-ion technology.

- optimal beaming and transmission of the light.
- bi-directional swivelling, sealing optical glass 3X

- Suitable for pneumatic test (supplied without ball).
- C handle runs Li-ion batteries, not included.

Supplied in deluxe hard case with one spare lamp, 4 reusable ear specula and 3 disposable ear specula. Spare ear speculum: use above 31817-31819 (autoclavable) or 31485 to 31499 (disposable) page 220.

• 31832 RI-SCOPE L2 XENON OPHTHALMOSCOPE - 3,5 V

The enhanced basic model with separately engageable red-free, blue and polarization filters for each aperture.

- Diopter wheel with 29 corrective lenses Plus 1-10, 12, 15, 20, 40 Minus 1-10, 15, 20, 25, 30, 35

- Easy-to-operate aperture hand-wheel with semi-circle, small/medium/large circle, fixation star, and slit

- Includes filter wheel engageable for all apertures with symbol display, red-free filter, blue filter and polarization filter

• 31826 XENON L1/L2/L3 OPHTHALMOSCOPE BULB 3,5 V - spare

• 31834 RI-SCOPE L2 LED OTOSCOPE + L2 XENON

OPHTHALMOSCOPE 3.5 V - C handle

• 31841 "C" SIZE Li-ion BATTERY

• 31840 RI-CHARGER L 230 V



Table recharge station (with wall holder) recharge 2 "C" handles with Li-ion batteries.

31840

GIMA OTOSCOPES: PARKER LINE

VETERINARY OTOSCOPES AND SETS SEE PAGE 370



31442



31440



BAYONET CONNECTION SYSTEM

PARKER OTOSCOPES

- reliable and indestructible high quality instrument
- suitable for everyday ear nose and throat examinations
- easily adjustable 2.5 V vacuum light (made in Germany)
- quality 3 times magnifying lens
- available with Plug in and snap (bayonet locking) or knurled screw type otoscope heads
- ideal for pneumatic tympanic membrane tests, can also be used for rhinoscopic examinations
- supplied with 3 autoclavable ear funnels in a colour coordinated zip bag.
- All latex free.
- require 2xC batteries (not included) 31542
- 31441 also works with rechargeable battery



code	PARKER OTOSCOPES	Connection system	Ear Funnels
31435	Parker colour - green	Bayonet	Ø 2.5, 3.5, 4.5 mm
31436	Parker colour - blue	Bayonet	Ø 2.5, 3.5, 4.5 mm
31437	Parker colour - yellow	Bayonet	Ø 2.5, 3.5, 4.5 mm
31440	Parker - black	Screw	Ø 2.5, 3.5, 4.5 mm
31441	Parker with rechargeable handle	Bayonet	Ø 2.5, 3.5, 4.5 mm
31442	Parker veterinary - black	Screw	Ø 4, 5, 7 mm
31449	Spare bulb 2.5 V for Parker otoscopes 31435-6-7,31440-1-2		
31542	Charging station for 31441		
34467	Rechargeable Li-ion battery 2.5 V / 2,200 mAh		

PARKER DIAGNOSTIC SETS

- **31471 PARKER DIAGNOSTIC SET**
Lightweight, semi rigid nylon case with one Parker otoscope 2.5 V with rechargeable handle, 3 autoclavable ear speculum (Ø 2.5, 3.5 and 4.5 mm), 2 laryngeal mirrors (size 3 and 4), bent arm throat lamp, tongue spatula, adjustable nasal speculum.
- **31473 PARKER LARGE SET WITH OPHTHALMO**
Same as code 31471 with an ophthalmoscope head, support for single use tongue depressors and 2 tubes of single use specula.
- **31446 VACUUM BULB FOR OPHTHALMOSCOPE**
- **31449 VACUUM BULB FOR OTOSCOPE**
- **32203 "C" ALKALINE BATTERIES** - blister of 2 pcs
- **34467 RECHARGEABLE LI-ION BATTERY 2.5 V** - needs 31542



31471



31473

LED OTOSCOPE - PEN LIGHT

- **31300 COMBI SET**
Dual function instrument features convertible diagnostic pen light and mini-otoscope with 3 different sizes of funnels or specula.
White Led light. Packed in a gift box.
Pupil gauge and dual slide rule printed on the penlight.
Supplied with batteries (2xAAA).
- **32200 "AAA" ALKALINE BATTERIES** - blister of 4 pcs
- **31345 REUSABLE EAR SPECULUM 2.0 mm** - bag of 25
- **31346 REUSABLE EAR SPECULUM 4.0 mm** - bag of 25



31300

XENON-HALOGEN OTO AND OPHTHALMOSCOPE SET



Rechargeable handle for use with 2xC batteries or rechargeable battery (34467)

31475

- **31475 XENON-HALOGEN PARKER OTOSCOPE**
Same as PARKER Oscope code 31440 but with halogen 2.5V bulb, and bayonet connection system. Supplied with 3 autoclavable ear funnels in a soft bag. Requires 2xC batteries (not included) or rechargeable battery.
- **31474 HALOGEN OPERATIVE PARKER OTOSCOPE**
Same as 31475 but with operative head.
- **31476 HALOGEN PARKER OPHTHALMOSCOPE**
2.5V halogen light for true tissue colour and consistent, long lasting illumination
24 colour coded lenses -25 to +40 dioptres for excellent resolution (green for +, red for -). Rubber eye brow rest to prevent scratching of eye-glasses. Illumination lens dial for clear identification of dioptre setting.
- **31477 HALOGEN OTO-OPHTHALMOSCOPE PARKER SET**
Diagnostic set including one handle, one halogen otoscope head and one halogen ophthalmoscope head, all in a plastic case.
- **31478 XENON-HALOGEN BULB FOR OTOSCOPE 2.5V**
- **31479 XENON-HALOGEN BULB FOR OPHTHALMOSCOPE 2.5V**
- **34467 RECHARGEABLE LI-ION BATTERY 2.5 V / 2,200 mAh**
- **31542 CHARGING STATION**
- **32203 "C" ALKALINE BATTERIES - blister of 2 pcs**



Supplied in a semi-rigid nylon bag with multilingual box and manual (GB, FR, IT, ES, PT, DE, GR, Arabic)

31476



31474



31477

All products are latex free.



+	1, 2, 3, 4, 5, 6, 8, 10, 12, 15, 20, 40
-	1, 2, 3, 4, 5, 6, 8, 10, 15, 20, 25

XENON-HALOGEN DIAGNOSTIC SETS IN RIGID CASES

- **31480 XENON-HALOGEN DIAGNOSTIC SET - 3.5 V**
- **31482 XENON-HALOGEN OPERATIVE DIAGNOSTIC SET - 3.5 V**
Both xenon-halogen sets are supplied in plastic rigid case containing: one rechargeable handle, one otoscope head (operative for code 31482) one ophthalmoscope head, 3 autoclavable speculum Ø 2.5, 3.5, 4.5 mm, two laryngeal mirrors (size 3 and 4), adjustable nasal speculum, bent throat lamp, tongue spatula. Should be used with 31541 + 31542.
- **31427 XENON-HALOGEN OTOSCOPE BULB 3.5V**
- **31428 XENON-HALOGEN OPHTHALMO BULB 3.5V**
- **31542 CHARGING STATION - 100-240 V - 50/60 Hz**
See details at page 327.
- **31541 RE-CHARGEABLE LI-ION BATTERY 3.5V***
*For handles sold after may 2013



Operative otoscope head



31542



31480

FIBRE OPTIC XENON-HALOGEN OTOSCOPES

- **31520 GIMALUX F.O. OTOSCOPE - black**
 - **31521 GIMALUX F.O. OTOSCOPE - blue**
 - **31522 GIMALUX F.O. OTOSCOPE - green**
- High professional plastic otoscopes with extra bright halogen light provided by fibre optic system. Quality 3 times magnifying movable lens. Output for pneumatic membrane test. Supplied with 14 single use mini speculums (7 Ø 2.5 and 7 Ø 4 mm) in a colour coordinated nylon bag. For mini ear-speculum see at page 220. All latex free.
- **34485 XENON-HALOGEN BULB 2.5V**
Old model with chrome insufflation adapter need below bulb
 - **31478 XENON-HALOGEN BULB 2.5V for old models**

Insufflation adapter



Fibre optic system



31521

31522

31520



DISPOSABLE EAR-SPECULUM FOR "TRADITIONAL" OTOSCOPES

code	DISPOSABLE EAR - SPECULUM FOR OTOSCOPES OF DIFFERENT BRANDS	Colour	To be used with	Minimum order
31313	Disposable ear-speculum Ø 2.5 mm	Black	Gowlands (with connector 31316) Riester (some models) Gowlands	box of 200 pcs. box of 200 pcs.
31315	Disposable ear-speculum Ø 4 mm	Black		
31316	Connector for 31313-31315	Black		
31504	Disposable ear-speculum Ø 2.5 mm	Black	Heine Beta 100, K100 and Eurolight, Kawe C10, C30, Combilight C10	box of 1000 pcs. (20 pack of 50) box of 1000 pcs. (20 pack of 50)
31505	Disposable ear-speculum Ø 4 mm	Black		
31506	Disposable ear-speculum Ø 2.5 mm	Grey	Riester: Ri-star	dispenser of 250 pcs. dispenser of 250 pcs.
31507	Disposable ear-speculum Ø 4 mm	Grey		
31508	Disposable ear-speculum Ø 2.5 mm	Black	Welch Allyn: Pocket-pro; Pocket scope Series 200, 250	dispenser of 250 pcs. dispenser of 250 pcs.
31509	Disposable ear-speculum Ø 4 mm	Black		



WELCH-ALLYN KLEENSPEC DISPOSABLE EAR SPECULUM

code	WELCH-ALLYN KLEENSPEC Disposable ear-speculum	Colour	To be used with	Minimum order	WelchAllyn®
72570	KleenSpec ear-speculum Ø 3 mm	Black	Welch-Allyn 20100, 20200 20202, 21600, 21700	box of 100 (4 packs of 25 pcs.) box of 100 (4 packs of 25 pcs.)	 72570
72571	KleenSpec ear-speculum Ø 4 mm	Black			
32105	KleenSpec ear-speculum Ø 2.75 mm	Black	Welch-Allyn, Macroview Riester Ri-scope L2, L3	box of 850 box of 850	
32106	KleenSpec ear-speculum Ø 4.25 mm	Black			

ALKALINE, LITHIUM AND ZINC-AIR "ACOUSTIC" BATTERIES



code	VARTA ALKALINE HIGH ENERGY BATTERIES	Type	Blister
32200	Varta ministilo H.E. - alkaline	AAA	4 pcs.
32201	Varta stilo H.E. - alkaline	AA	4 pcs.
32203	Varta half torch H.E. - alkaline	C	2 pcs.
32204	Varta torch H.E. - alkaline	D	2 pcs.
32205	Varta 9V H.E. - alkaline	9V	1 pc.

code	VARTA ENERGY ALKALINE BATTERIES - BULK	Type	Box
32202	Varta Energy Stilo - alkaline	AA	24 pcs.

code	VARTA LITHIUM BATTERIES - BUTTON	Blister
32210	Varta 2016 - lithium button	1 pc.
32211	Varta 2025 - lithium button	1 pc.
32212	Varta 2032 - lithium button	1 pc.

code	RAYOVAC ZINC-AIR "ACOUSTIC BATTERIES" - mercury free	Blister
32220	Rayovac 675 - zinc air - acoustic	6 pcs.
32221	Rayovac 13 - zinc air - acoustic	6 pcs.
32222	Rayovac 312 - zinc air - acoustic	6 pcs.
32223	Rayovac 10 - zinc air - acoustic	6 pcs.

RECHARGEABLE BATTERIES AND CHARGERS

code	VARTA POWER PLAY RECHARGEABLE BATTERIES	Type	Blister
32235	Varta ministilo - 1000 mAh	AAA	2 pcs.
32236	Varta stilo - 2400 mAh	AA	4 pcs.

code	CHARGERS FOR ANY BRAND	Power supply	Sizes mm	Weight g	To be used with:	Recharging time	Supplied with:	12V+USB adaptor
32241	Universal charger	100 - 240 V	172x109x53	403	AAA, AA, C, D, 9C	5 h	-	no
32242	LCD charger	110 - 240 V	120x230x75	359	AAA, AA	2-4 h	4AA	yes



GIMA DISPOSABLE EAR-SPECULUM FOR MINI OTOSCOPES OF DIFFERENT BRANDS

code	GIMA DISPOSABLE SPECULUM FOR MINI OTOSCOPES - LATEX FREE	Colour	Compatibility		Minimum order
			Direct fit	Fit with connector 31493	
31485	Disposable Mini ear-speculum Ø 2.5 mm - grey	■	Gima 31520-22, 31525-26, 31535, 31545 Heine mini 2000, 3000, K180/Beta 200 Riester Ri-Mini, Ri-scope L1-L2, E-scope, Pen-scope Kawe (Picolight, Combilight F030, Eurolight F030) Holtex Colson Luxamed	Gima: 31435-37, 31440-42, 31471, 31473, 31475, 31477, 31480, 31493	dispenser of 250 dispenser of 250 dispenser of 250 pack of 100 box of 1,000 pack of 100 pack of 100 pack of 100
31486	Disposable Mini ear-speculum Ø 4 mm - grey	■			
31487	Disposable Mini ear-speculum Ø 2.5 mm - black	■			
31488	Disposable Mini ear-speculum Ø 4 mm - black	■			
31491	Disposable Mini ear-speculum Ø 2.5 mm - black	■			
31492	Disposable Mini ear-speculum Ø 4 mm - black	■			
31495	Disposable Mini ear-speculum mixed colours and Ø	■			
31496	Disposable Mini ear-speculum Ø 2.5 mm - blue	■			
31497	Disposable Mini ear-speculum Ø 4 mm - blue	■			
31498	Disposable Mini ear-speculum Ø 2.5 mm - green	■			
31499	Disposable Mini ear-speculum Ø 4 mm - green	■			

code	CONNECTORS FOR MINI EAR SPECULUM	Colour	To be used with GIMA codes
31493	Connector to GIMA Parker otoscope for Mini ear-speculum	■	31435, 31436, 31437, 31440, 31441, 31442, 31471, 31473, 31475, 31477
31494	ALLIGATOR connector (supplied with 100 ear speculum)	■	31435, 31436, 31437, 31440, 31441, 31442, 31471, 31473, 31475, 31477

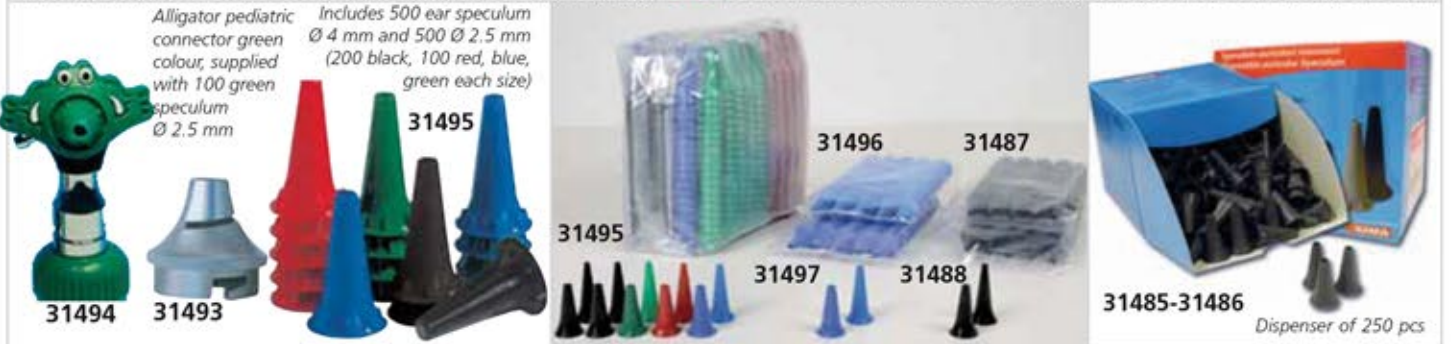

HEINE DISPOSABLE MINI EAR-SPECULUM



code	HEINE DISPOSABLE MINI EAR SPECULUM*	Minimum order
31501	HEINE dispenser for mini speculum - empty	-
31502	HEINE disposable Allspec® speculum Ø 2.5 mm - grey	dispenser of 250
31503	HEINE disposable Allspec® speculum Ø 4 mm - grey	dispenser of 250
31515	HEINE disposable Allspec® speculum Ø 2.5 mm - grey	box of 1,000
31516	HEINE disposable Allspec® speculum Ø 4 mm - grey	box of 1,000

*Compatible with Heine Mini 2000/3000 K180, Beta 200

RIESTER AUTOCLAVABLE MINI EAR-SPECULUM



code	AUTOCLAVABLE MINI EAR SPECULUM	Colour	Minimum order
31817	Riester ear speculum Ø 2,5 mm - black	■	box of 10 pcs.
31819	Riester ear speculum Ø 4 mm - black	■	box of 10 pcs.

REUSABLE CANNULAS AND EAR SPECULUM

code	AUTOCLAVABLE SPECULUM FOR PARKER OTOSCOPES - LATEX FREE	Colour	To be used with GIMA code	Also compatible with	Minimum order
31447	Kit 3 autoclavable veterinary speculum Ø 4, 5, 7 mm	■	31435-37, 31440-42, 31471, 31473, 31475, 31477, 31480	Heine, Kawe, Riester	One kit
31448	Kit 3 autoclavable speculum Ø 2.5, 3.5, 4.5 mm	■	31435-37, 31440-42, 31471, 31473, 31475, 31477, 31480	Heine, Kawe, Riester	One kit
31451	Kit of 5 autoclavable speculum Ø 2.5, 3.5, 4.5, 5.5, 9 mm	■	31435-37, 31440-42, 31471, 31473, 31475, 31477, 31480	Heine, Kawe, Riester	One kit
31453	Kit of 3 metal cannulas (Ø 4, 5, 6 mm) + 2 slotted metal specula (Ø 7.5 and 9.4 mm)	■	31435-37, 31440-42, 31471, 31473, 31475, 31477, 31480	Heine, Kawe, Riester	One kit
31500	Pneumatic bulb for Otoscopes	■	31435/36/37/40/42/71/73/75/77-31520/21/22, 31535	Heine, Kawe, Riester	-

Gima autoclavable ear speculum 31447, 31448, 31451 features:
 - made from resilient thermoplastic material
 - smooth and shiny surface ensure easy cleaning
 - Metallic bayonet lock for positive fit to otoscope
 - autoclavable at 134°C



2 slotted models with 60 mm opening and round edges, ideal for instrumentation, atraumatic insertion

Matt inner surface to reduce risk of reflection

OTOSCILLO® ELECTRICAL IRRIGATION DEVICE

- 25815 OTOSCILLO®
- 25800 PROFESSIONAL OTOSCILLO®

Otosillo® is designed for automated ear rinsing both in hospitals and during private consultations. Innovative, compact, efficient and rapid, the Otosillo® combines the most sophisticated operating qualities with the best security guarantees, all in a single device.

Anywhere, anytime

Otosillo® is an electrical irrigation for simplified rinsing of the ear canal. The pulsating stream system makes it easier to remove cerumen, even at low pressure control, Otosillo® is particularly adapted to the treatment of sensitive ear canals. It looks less alarming and it is easier to use, with greater accuracy and security, than the alternatives. The water basin is removable to allow easy filling and emptying. Can be mounted on a wall (only 25815) or a cupboard.

Operating power: 220V - 50/60 Hz.

Professional Otosillo® same as 25815, but supplied with automatic back stop behind disposable nozzle for preventing cross-infections.

- 25816 SPARE SET (2 reusable tips + disk) for 25815
- 25817 SPARE HANDLE + TUBE
- 25814 DISPOSABLE TIPS SET

(100 disposable tips, 1 disk, connector) for 25800 and 25815

- 25818 DISPOSABLE TIPS for 25800 - box of 100



25800



Removable tips

Manual in GB, FR, DE, IT, ES.



Made in Germany

25815

Otosillo is supplied with applicator set (1 long nozzle, 1 short nozzle, 1 splash guard) carrying handle and temperature test card

Water temperature control system

GLASS-METAL, ALL-METAL AND SINGLE-USE EAR SYRINGES



MADE IN GERMANY

GLASS-METAL JANET RECORD SYRINGES

High quality, reliable and accurate glass-metal syringes. Janet Record come complete with 2 cannulas, one conical, one oval. Individually packed in cardboard box. Made in Germany.

code	GLASS-METAL SYRINGES COMPLETE WITH 2 CANNULAS
25801	Janet Record 50 cc - 13 x Ø 3.5 cm
25802	Janet Record 100 cc - 14 x Ø 4.7 cm
25803	Janet Record 200 cc
25804	Spare cannula for Janet Record (conical shape)
25805	Spare cannula for Janet Record (olive shape)

ALL-METAL SCHIMMELBUSCH SYRINGES

High quality, reliable and accurate syringes. Schimmelbusch come complete with 3 cannulas and ear bowl. Individually packed in cardboard box. Made in Germany.

code	ALL-METAL SYRINGES COMPLETE WITH 3 CANNULAS AND EAR BOWL
25806	Schimmelbusch 50 cc
25807	Schimmelbusch 100 cc
25808	Schimmelbusch 200 cc
25809	Spare cannula for Schimmelbusch (conical shape)
25812	Spare cannula for Schimmelbusch (olive shape) small
25813	Spare cannula for Schimmelbusch (olive shape) large

HIGH CAPACITY POLYPROPYLENE SYRINGES

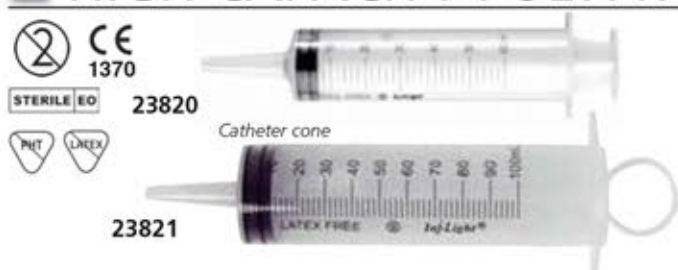

STERILE EO 23820



23821

Catheter cone

HIGH CAPACITY POLYPROPYLENE SYRINGES - sterile

Sterile, single use, latex free syringes for ear and other purposes. Box in GB, FR, IT, ES, DE, PT, GR, RO, RU, YU, SA. Medical Device class IIa.

code	HIGH CAPACITY, POLYPROPYLENE SYRINGES STERILE - CATHETER CONE	Minimum order
23820	Syringe 60 ml	box of 20
23821	Syringe 100 ml	box of 25

OTOCLEAR® EAR IRRIGATION SYSTEM

Kit includes:
1 spray wash bottle
20 otoclear tips
1 ear basin

BIONIX

CE FDA



25858



- 25858 OTOCLEAR EAR SPRAY WASH
- manual, intermittent lavage
- delivers greater volume compared to syringes or other manual devices
- efficient design allows for two handed procedure

- 25861 OTOCLEAR EAR IRRIGATION TIPS
single use - box of 40 - spare
Flared design protects against over-insertion. The tip directs three streams of water towards the walls of the ear canal, away from the tympanic membrane, creating a turbulent lavage that effectively dislodges the cerumen. The exit portal controls backsplash and directs drainage into a basin.
- 25862 EAR IRRIGATION BASINS - box of 3 - spare



Thermometer for water temperature

Improved patient comfort thanks to the soft "gentle touch" design



Patented 3-stream action

LOOP-SPOON EAR CURETTES

- 31470 GIMA EAR CURETTES - box of 10 pcs
Double function currettes: one side spoon, one side loop. Each currette is individually packed in a single pouch.

31470



Loop side

Spoon side

BIONIX EAR CURETTES

FLEXLOOP:
For normal curettage
Most flexible of all
Least traumatic
Rounded tips for comfort
4 mm wide tip

INFANTSCOOP:
For the smallest ears
For when a small scoop works better
Can be used through an otoscope • Flexible
2 mm wide tip

MICROLOOP:
For compact cerumen
More rigid construction
Tip can be angled for added strength
Rounded tip for comfort
3 mm wide tip

CERASPOON:
For viscous cerumen
For extensive cerumen buildup
For when a large scoop works better
4 mm wide tip

The complete cerumen management system

- 31462 FLEXLOOP - white - box of 50 pcs
- 31464 INFANTSCOOP - light blue - box of 50 pcs
- 31460 MICROLOOP - green - box of 50 pcs
- 31467 CERASPOON - yellow - box of 50 pcs

Our four styles of currettes give you the most effective, economical and safe way to remove cerumen - whatever the size of ear or consistency of cerumen.

Patient comfort: Metal currettes are cold, hard and sharp. BIONIX ear currettes with rounded plastic tips reduce trauma and risk of laceration. Latex free.

Effectiveness: Ear currettes can duplicate the effectiveness of metal currettes in almost any situation and their polypropylene composition makes them virtually unbreakable.

Disposability: Ear currettes don't require expensive and time-consuming sterilization and eliminate the risk of cross-contamination.



BIONIX

LIGHTED EAR CURETTES

- 31450 KIT MIXED LIGHTED CURETTES
Kit is composed by 50 lighted currettes (8 FlexLoop and 7 of each of below other 6 tip styles) + LED illuminator + magnification lens

BIONIX

CE FDA



MicroLoop®
3 mm diameter loop

FlexLoop®
4 mm diameter tip

InfantScoop®
2 mm diameter tip

AngleLoop®
Angled 4 mm diameter loop

WaveCurette™
new wave like 2.5 mm tip

VersaLoop®
3 mm wide tip

CeraSpoon®
4 mm wide tip

Scan QR code with your web enabled camera phone to see Video



31458

Lighted forceps for foreign body removal with LED illuminator



31459

Lighted ear currette 3 mm tip with LED illuminator

- 31461 KIT MICROLOOP
- 31463 KIT FLEXLOOP
- 31465 KIT INFANTSCOOP
- 31466 KIT ANGLELOOP
- 31468 KIT VERSALOOP

All kits are composed by 50 lighted currettes + LED light source + magnification lens

- 31458 LIGHTED FORCEPS - box of 10 + magnification lens + LED illuminator
- 31459 LIGHTED ARTICULATING CURETTES - box of 25 + magnification lens + LED light source

Ear currette tip has a 90° range of motion. It articulates to assist in removal of cerumen from the ear canal



MEDICAL DESIGN EXCELLENCE AWARDS 2008 WINNER

WOOD TONGUE DEPRESSORS



PERSONALIZATION
minimum: 100,000 pieces
ask for leaflet

Quality tongue depressors manufactured with selected high quality smooth birch wood. Edges accurately finished. 150x18x1.6 mm. Individually packed in a paper envelope and sterilized.

code	WOOD TONGUE DEPRESSOR - STERILE
25511	Tongue depressor - box of 50
25512	Tongue depressor - box of 2,000 (40 boxes of 50 pcs)



Wooden medical tongue depressors made of quality birch wood. Edges accurately finished. Size: 150x18x1.6 mm Made in PRC.

code	WOOD TONGUE DEPRESSORS NON-STERILE
25509	Tongue depressor - box of 100
25510	Tongue depressor - box of 5,000 (50 boxes of 100 pcs)

PLASTIC TONGUE DEPRESSORS



Multilanguage box: GB, FR, IT, ES, DE, PT, GR, Arab

25505 PLASTIC COLOURED TONGUE DEPRESSORS

Plastic tongue depressor animal shaped with bright colour. Each tongue depressor is individually packed in transparent pouch. Packed in box of 50 pieces.

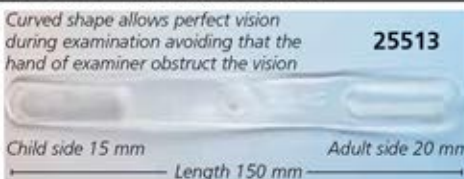

Curved shape allows perfect vision during examination avoiding that the hand of examiner obstruct the vision. Translucent tongue depressors made in polystyrene with curved shape and smooth edges. One end in adult size and one end in child size. Latex and PVC free. Sterile model is individually packed in a peel-open pack (ethylene oxide).

code	PLASTIC TONGUE DEPRESSORS ADULT/PEDIATRIC NON-STERILE	CE
25513	Tongue depressor - box of 100	CE 0120
25515	Tongue depressor - box of 90	
25516	Tongue depressor - box of 1,800 (20 boxes of 90 pcs)	

STERILE ENT KITS

31456 STERILE ENT KIT A - box of 25 pcs. Kit includes one plastic nasal speculum, one plastic tongue depressor and two (adult and pediatric size) plastic ear funnels in single sealed pouch.

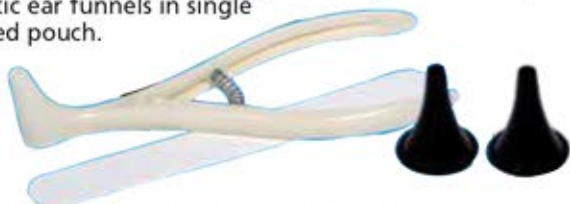

31457 STERILE ENT KIT B - box of 10 pcs. Kit includes one plastic nasal speculum, one plastic tongue depressor, two (adult and pediatric size) plastic ear funnels, two plastic laryngeal mirrors, one plastic forceps, six cotton tip applicators, one napkin, all packed in a sterile plastic tray.



CE 0476

CE 0123

THROAT SCOPE®



25498 THROAT SCOPE® KIT

1 handle + 3 blades - blister Throat Scope is an illuminated tongue depressor that allows the clinician a one handed operation for oral cavity examination. The light is guided by the blade to illuminate the mouth for a quick examination by the clinician. Light is automatically activated when you insert single use blade into the handle.

25499 THROAT SCOPE® DISPOSABLE BLADES - box of 100 - non sterile



Simultaneously depresses the tongue and illuminates the mouth

NASAL SPECULUM

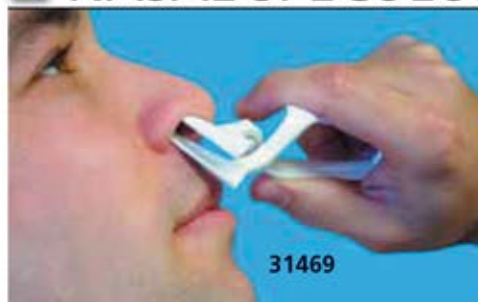

31469

The use of stainless steel speculum can be a chilling experience for the patient. Now you can combine patient comfort with effective treatment. Smooth, warm tips make disposable Nasal Speculum more comfortable and less alarming to the patient.

31469 DISPOSABLE NASAL SPECULUM - box of 48 Innovative plastic, disposable nasal speculum with handle: allows superior view of nasal cavity. Helps extract foreign objects from nasal cavity. Facilitates packaging of cauterizing of bleeding noses. Latex free.



CE 31469

WELCH ALLYN HALOGEN PROFESSIONAL PENLIGHT

- 25622 W.A. HALOGEN PENLIGHT with 2 x AAA batteries
Bright white halogen light.
Durable solid brass construction.
- 25618 BULB for W.A. PENLIGHT - spare



TOP QUALITY BULB OR LED PENLIGHTS - MADE IN GERMANY

Professional penlights, also suitable for diagnostic, with bulb or white LED with quick clip shifter mechanism or push button (25634).

Argenta and Elegance made of anodized aluminium, Nova in top-quality ABS plastic housing. Supplied with 2x1.5V AAA batteries.



code	Description	Light	Material	Supplied with batteries	Colour	Origin	on/off by
25632	Argenta torch	bulb	metal	2 x AAA	black	Germany	Pocket clip
25633	Argenta torch	bulb	metal	2 x AAA	silver	Germany	Pocket clip
25638	Argenta torch	bulb	metal	2 x AAA	green	Germany	Pocket clip
25634	Elegance torch	bulb	metal	2 x AAA	blue	Germany	Push button
25440	Nova torch	LED	plastic	2 x AAA	white	Germany	Pocket clip
25442	Argenta torch	LED	metal	2 x AAA	blue	Germany	Pocket clip

BULB OR LED TORCHES PENLIGHTS



code	Description	Light	Material	Supplied with batteries	Colour	Packaging	Origin	on/off by
25626	Alfa torch	bulb	plastic	2 x AAA	blue	Blister	Asia	Pocket clip
25627	Alfa torch	bulb	plastic	2 x AAA	white	Blister	Asia	Pocket clip
25639	Beta torch	bulb	stainless steel	2 x AAA	silver	Plastic case	Asia	Push button
25434	Stylo torch	bulb	metal	2 x AAA	white	Blister	Asia	Push button
25641	Spirit torch	LED	chrome plated brass	2 x AAA	silver	Box	Asia	Pocket clip
25436	Omega Torch	LED	metal	2 x AAA	silver	Plastic case	Asia	Pocket clip
25437	Omega Torch	LED	metal	2 x AAA	gold	Plastic case	Asia	Pocket clip
25624	GIMA torch	LED	metal	2 x AAA	silver	Box	Asia	Push button

DELTA PENLIGHTS WITH TONGUE DEPRESSOR HOLDER

- 25628 DELTA "LED" PENLIGHT - red
 - 25629 DELTA "LED" PENLIGHT - blue
- Delta penlights are supplied in aluminium box with 2 AAA batteries and holder for tongue depressors (tongue depressor not included).
Manual in: GB, FR, IT, ES.



- 25625 DELTA "LED" OTOSCOPE PENLIGHT - black
- Same as 25628-9 but with otoscope head, 3 ear funnels and 5 black plastic tongue depressors.
- 31345 REUSABLE EAR SPECULUM 2.0 mm - bag of 25
 - 31346 REUSABLE EAR SPECULUM 4.0 mm - bag of 25



NEUROLOGICAL REFLEX PERCUSSORS - LATEX FREE



code	PERCUSSORS	Colour	Handle	Pin	Brush	Weight	Length
31270	Buck Gima 2000	green	plastic/stainless steel	yes	yes	85 g	18 cm
31251	Buck Classic	silver	chromed brass	yes	yes	90 g	18 cm
31252	Buck colour-yellow	yellow	brass colour coated	yes	yes	90g	18 cm
31271	Dejerine Gima 2000	blue	plastic/stainless steel	yes	yes	110 g	21 cm
31254	Dejerine Classic	silver	stainless steel	yes	yes	140 g	21 cm
31255	Dejerine colour	red	brass colour coated	yes	yes	125 g	21 cm
31256	Babinsky - Ø 4.5 cm	silver	chrome plated	yes	no	170 g	24 cm
31257	Queens - Ø 5 cm	silver	flexible plastic	no	no	100 g	33 cm
31258	Troemner	silver	stainless steel	no	no	200 g	23 cm
31260	Pinwheel	silver	chrome plated	no	no	50 g	18 cm
31272	Babinsky-Gima 2000	green	plastic	no	yes	80 g	24 cm
31273	Taylor Gima	red	plastic/stainless steel	no	yes	70 g	20 cm



NEUROLOGICAL KIT

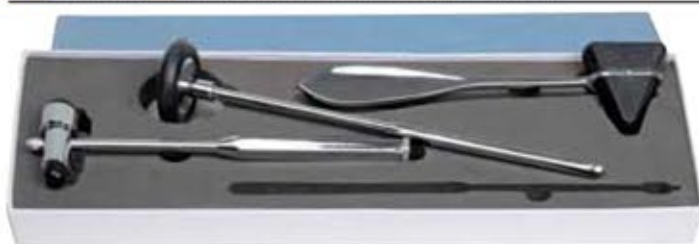

• **31265 NEUROLOGICAL KIT - 3 hammers** 31265
This kit includes 3 metal hammers in a foam box: Taylor hammer, Buck hammer and Babinsky hammer.

MONOFILAMENT - SENSORY EVALUATOR

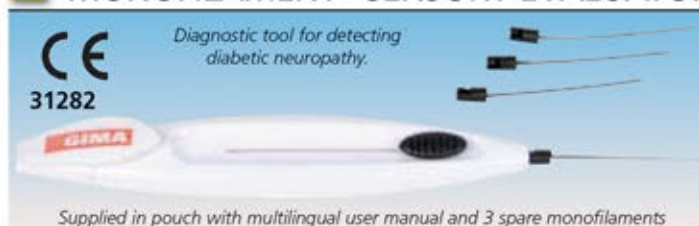

• **31282 MONOFILAMENT TOOL - sensory evaluator**
Plastic retractable monofilament with 3 spare monofilaments. Evaluates both diminishing and returning sensation (touch test). Examines levels of sensory function and changes in neuro status. Monofilament is calibrated at 10 g. Size: 13x2.5 cm + 4 cm monofilament

• **31281 KIT OF 3 MONOFILAMENTS - spare**



THERMO FEEL

• **31278 THERMO FEEL**
Useful tool for diagnosis of neuropathy in diabetes patients. Both sides (one stainless steel and one plastic) are alternatively put in contact with foot skin of the patient. Patient perception of cool or warm allows a first diagnosis of diabetes.



TWO POINTS DISCRIMINATOR

• **31279 TWO POINTS DISCRIMINATOR**
Plastic (ABS) caliper with scale printed on aluminium plate. Two point discrimination is the ability to discern that two nearby objects touching the skin are truly two distinct points, not one.

It is often tested with two sharp points during a neurological examination and reflects how finely innervated an area of skin is. Reliable and widely used technique for determining tactile gnosis.

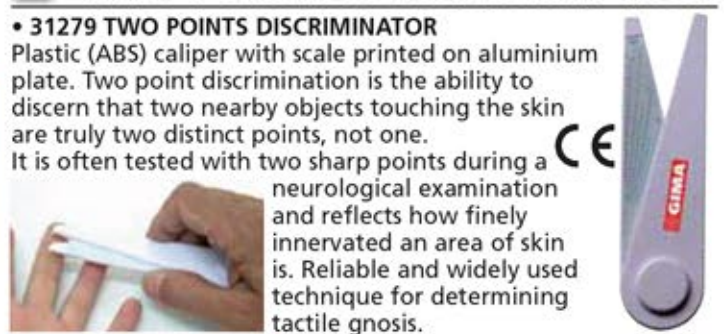

TRIGONAL MONOFILAMENT

• **31277 TRIGONAL MONOFILAMENT**
Trigonal shape diabetic monofilament with 3 different monofilament diameters: 0.4, 0.5 and 0.7 mm



GERMAN-MADE DIAPASONS - TUNING FORKS



ENT TUNING FORKS:

All made in Germany, with age-long craftsmanship experience, in special alloy that ensures maximum sound precision.

code	ENT TUNING FORKS
31230	Tuning fork 128 Hz* - with weight
31231	Tuning fork 256 Hz* - with weight
31232	Tuning fork 512 Hz
31233	Tuning fork 1024 Hz
31234	Tuning fork 2048 Hz
31235	Tuning fork 4096 Hz
31240	Set of 5 tuning forks in a stylish lined case (contains 128 Hz*, 256 Hz*, 512 Hz, 1024 Hz, 2048 Hz). <i>Tuning forks with asterisk * are supplied with weight</i>

ENT/NEUROLOGY TUNING FORKS

All made in a special alloy and supplied with base.

code	ENT/NEUROLOGY TUNING FORKS
31245	Tuning fork a1-440 Hz - ENT - 90 g
31246	Tuning fork - LUCAE - 85 g adjustable from c128 to h240 with foot
31247	Tuning fork C64, c128 - RYDEL SEIFFER detachable slider either C64 or c128 - 130 g
31249	Hammer neurotone 5 in a lined case

Neurotone hammer: set of 5 components for a complete neurological examination: percussion hammer + tuning fork 256 Hz with weight + pin + brush. All fitted in a stylish case.



ALUMINIUM ALLOY DIAPASONS - TUNING FORKS

- 31225 ALUMINIUM TUNING FORK 128 Hz
- 31226 ALUMINIUM TUNING FORK 128 Hz - with foot

Made of finest aluminium alloy and precisely shaped to meet highest requisites (standards) in medical field.

Resting pad for forehead



NYSTAGMUS SPECTACLES - DR. FRENZEL - MADE IN GERMANY

• 31204 NYSTAGMUS SPECTACLES - DR. FRENZEL - black
Easy to use in the search of spontaneous or provoked nystagmus. Fixed, biconvex lens + 18.0 diopters. Nystagmus spectacles should be connected only with < 4.2 V transformer as per safety norms 93/42/EEC. See code 31203 or 31214

• 31214 BATTERY handle for 31204
Offers mobility during examination. Needs 3x1.5 V CLR14 batteries (not included)

• 31203 PLUG-IN TRANSFORMER for 31204

• 31206 BATTERY NYSTAGMUS SPECTACLES - DR. FRENZEL - black
This model allows wireless working and is provided with power through the adjustable battery placed above the spectacle. Requires three 1.5 Volt batteries, size C LR14/AM-2 (baby cells). Illumination can be adjusted through a turn of the switch.

• 31208 NYSTAGMUS BULB - spare for 31204, 31206

4 Volt 0.230 Ampere, 1 Watt threading Ø 3.5x0.35 mm

• 31207 LED BATTERY NYSTAGMUS SPECTACLES - white
Same as 31206 with LED and inner function that makes easier watching the rashes within a particular time period (30, 60, 90 seconds).

• 31209 LED POWER SUPPLY NYSTAGMUS SPECTACLES - white
Same as 31204 with LED and rechargeable power supply.



Suggested for long examinations

Supplied with head strip

31204

LED + BATTERY

Suggested for short examinations

Adjustable illumination through a slight turn around of the switch

31207

LED + POWER SUPPLY

Supplied with head strip, rechargeable power supply

Adjustable illumination

31209

USB VIDEONYSTAGMOSCOPE SYSTEMS

• 31213 VIDEO-NYSTAGMOSCOPE - USB - mask with Ir camera and USB cable
Facilitate to view and register the Nystagmus through standard vestibular tests (both position and instrumental proof).

This system allows to view on the monitor or PC/Notebook images of patient eyes during tests and to make Visual Suppression Test (VST) through a green LED light inside the mask to allow fixation. Innovative technology allows to get quality images. Power 12V DC.



752x582 pixels resolution
520 TV lines

31213

OPTOMETRIC CHARTS

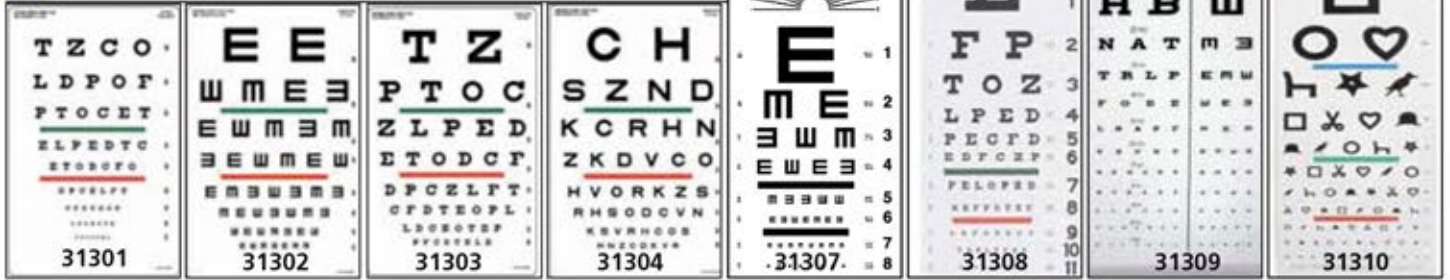

code	OPTOMETRIC CHARTS*	Working distance	Size cm
31301	SNELLEN eye chart with red/green bar visual acuity test	10 feet 3 m	23x35.5
31302	TUMBLING "E" colour vision chart-visual acuity screen	20 feet 6.1 m	23x35.5
31303	SNELLEN eye chart for visual acuity and colour vision test	20 feet 6.1 m	23x35.5
31304	SLOAN colour bar visual acuity chart	20 feet 6.1 m	23x35.5
31307	TUMBLING "E" eye chart	20 feet 6.1 m	28x56
31308	TRADITIONAL SNELLEN eye chart	20 feet 6.1 m	28x56
31309	MIXED DECIMAL chart	10 feet 3 m	28x56
31310	EWING illiterate test chart	20 feet 6.1 m	28x56
31311	SLOAN near vision chart (2 sides printed)	16 inches 40 cm	18x23



*Polypropylene natural white sheet, approx. thickness 0.8 to 1.0 mm

LEA SYMBOLS AND NUMBERS VISION CARDS AND CHARTS



• 31322 LEA SYMBOLS NEAR VISION CARD - 40 cm (16 inches)

This test measures near visual acuity with proportionally spaced (logMAR) lines on the front and lines with 25% and 50% spacing on the back. Response key printed on test card. Includes training cards and instructions. Card measures 20.3x25.4 cm (8x10").

• 31323 LEA SYMBOLS 15-LINE DISTANT CHART - 3 m (10 feet)

This test is designed for vision screening at schools and assessment of vision of children with special needs beginning with age of 3 years. Has a hole for hanging the chart on the wall. Includes response key, training cards, and instructions. 43x53.4 cm (17x21"). Folds to 43x26.7 (17x10.5").

• 31324 LEA NUMBERS NEAR VISION CARD - 40 cm (16 inches)

Designed to measure visual acuity with a standard line test and with three tighter spaced tests; 50%, 25%, and 12.5%, which often reveal difficulties in seeing tightly crowded details. Card measures 20.3x25.4 cm (8x10").

• 31325 LEA NUMBERS 15-LINE DISTANT CHART - 3 m (10 feet)

This test is designed for vision screening at schools and assessment of vision of children with special needs beginning with age of 5 years. Has hole for hanging on the wall. 45.7x50.8 cm (18x20"). Folds to 45.7x25.4 (18x10").

LOW CONTRAST CHARTS



• 31317 CONTRAST SENSITIVITY CARD - NEAR VISION 40 cm size 40x34 cm

• 31318 CONTRAST SENSITIVITY CHART - FROM A DISTANCE 3 m size 77x61 cm

It checks for the ability to distinguish light and dark (contrast). It can detect vision problems. Also useful to reveal in time regression or progression of the cataract disease.

OCCLUDERS



• 31275 EYE OCCLUDER - 170x200x3 mm

• 31274 OCCLUDER - 154 x Ø 47 mm

• 31276 FUN FROSTED OCCLUDER GLASSES Set of two tiger fun frosted glasses to be used as occluder during children examinations one to occlude each eye.

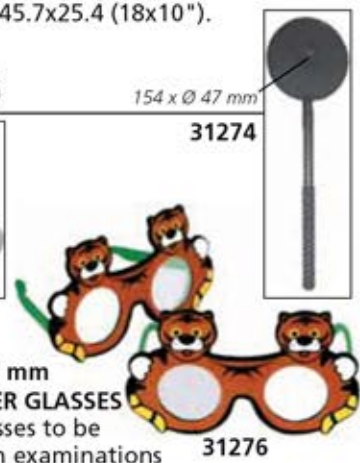

OPTOMETRIC PENCILS

• 31319 OPTOMETRIC PENCILS - set of 2 pcs

Set of two wooden puppets (red and white) used to capture attention during vision evaluation in young non-verbal children. Can also be used for test of convergence.

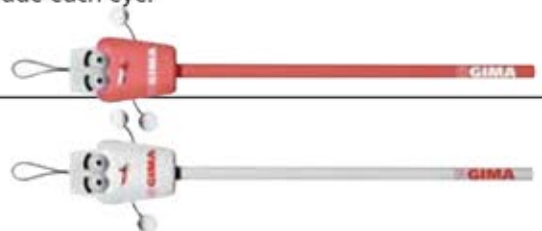

ISHIHARA COLOUR TEST

ISHIHARA Colour TEST

These series of plates are designed to provide a test which gives a quick and accurate assessment of colour vision deficiency of congenital origin. This is the most common form of colour vision disorders. Most cases of congenital colour vision deficiency are characterized by a red-green deficiency which may be of two types: a protan type which may be absolute (protanopia) or partial (protanomalina), and a deutan type which may be absolute (deutanopia) or partial (deutanomalina).



code	ISHIHARA COLOUR TEST
31290	Book of 10 plates for illiterates
31291	Book of 24 plates
31292	Book of 38 plates

STEREOPSIS TESTS

- 31283 FLY STEREO ACUITY TEST
- 31284 BUTTERFLY STEREO ACUITY TEST 31284

Designed to rapidly test for amblyopia and strabismus using gross to fine stereopsis (4800 to 20 sec of arc):

- graded circle test from 400 sec now down to 20 sec
- new technology → no monocular clues
- answer key on back cover
- includes pair of standard polarised viewers



- 31285 RANDOM DOT STEREO ACUITY TEST

Designed to rapidly test for amblyopia and strabismus in early and non-readers and non-verbal children and adults

- expanded random dot lea test (500, 250, 125, 63 sec of arc)
- graded circle test now down to 12.5 sec
- answer key on back cover
- includes pair of standard polarised viewers



STEREOPTIC TEST

- 31293 STEREOPTIC TEST

This test is performed at a distance of 30-40 cm and allows evaluation of the cooperation between the two eyes to form a single image to the brain from the two image provided separately by each of the two eyes.

It can be used for children from the age of one year and adults if you suspect strabismus, amblyopia or visual reduction of one or both eyes.

Gima stereoptic test contains one ball, one fish, one star, one tree. Ball can be seen by one eye only.



GIMA COLOUR TEST

- 31287 GIMA ADULT COLOUR TEST - 15 plates
 - 31286 GIMA PEDIATRIC COLOUR TEST - 10 plates
- Single plates packed in a practical aluminium box.

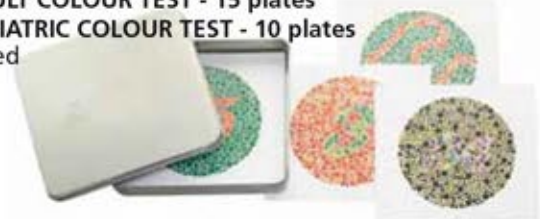

WORTH LED LIGHT TEST

- 31289 WORTH LED LIGHT TEST - with red/green glasses

The Worth 4 dot test, is a clinical test for suppression of either the right or left eye. Suppression occurs during binocular vision, when the brain does not process the information received from either of the eyes. This is a common adaptation to strabismus, amblyopia, and aniseikonia.

Battery not included, glasses included.



LANG STEREO TEST

- 31294 LANG STEREO TEST I
- 31295 LANG STEREO TEST II

Stereotest I was created to simplify stereopsis screening in children. It is based on two principles: on random dots and on cylinder gratings.

Stereotest II is a further development and helps the assessment of binocular vision.



- 31296 LANG FIXATION STICK

- 31297  • 31297 LANG FIXATION CUBE - white
- 31298  • 31298 LANG FIXATION CUBE - red

SCHIÖTZ TONOMETER

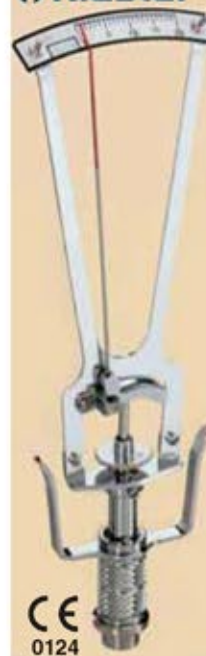

- 31220 SCHIÖTZ TONOMETER - straight scale
- 31222 SCHIÖTZ TONOMETER - inclined scale

A masterpiece of precision mechanism, measures intraocular pressure according to Prof. Schiötz standards.

Vital parts are made of stainless steel. High quality agate bearing for extremely long service life.

Set 3 weights included (5.5-7.5-10 g). Scale specification 5. In black deluxe case with velvet-look inserts.

Perfect reading of the scale with red pointer. Made in Germany.



CE 0124

31220 straight

31222 inclined

TRAD STETHOSCOPES - GOOD VALUE FOR MONEY

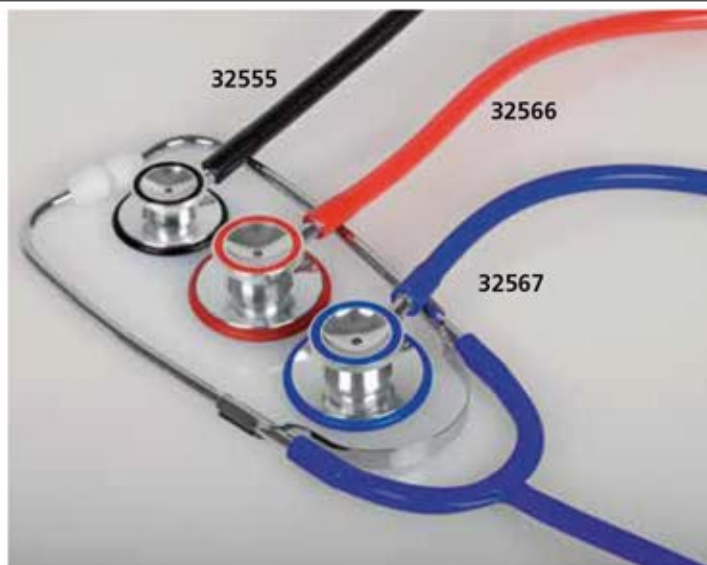
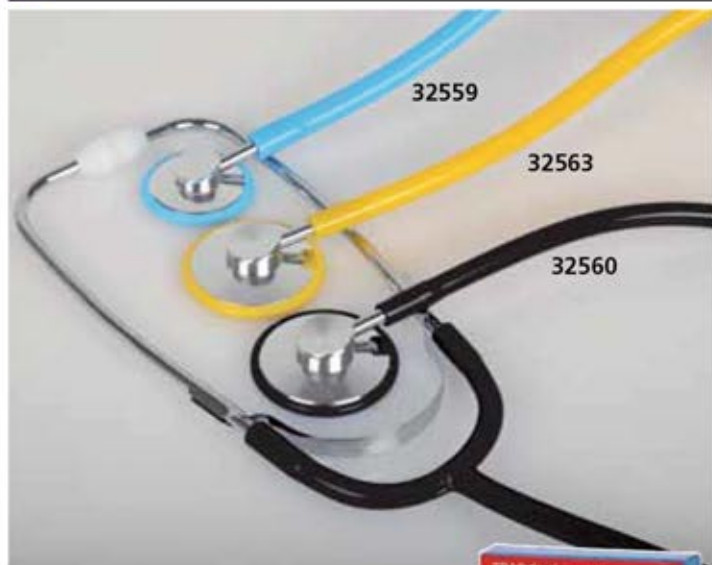

TRAD STETHOSCOPES: adult, pediatric
 Traditional aluminium stethoscopes, lightweight and reliable.
 Chestpiece diaphragm Ø 43.5 mm (Ø 35 for pediatric model), bell Ø 30 mm (Ø 26.5 for pediatric model) external sizes.
 Brass binaural, non chill ring.
 Tubing: length 62 cm, int. Ø 4 mm, ext. Ø 8 mm.
 Supplied in cardboard box. Manual and box in 11 languages: GB, FR, IT, ES, DE, PT, GR, PL, HU, SE, Arabic.



code	TRAD STETHOSCOPES - LATEX FREE	
32557	TRAD single head - pediatric - pink	
32559	TRAD single head - pediatric - light blue	
32555	TRAD double head - pediatric - black	
32560	TRAD single head - black	
32561	TRAD single head - red	
32562	TRAD single head - blue	
32563	TRAD single head - yellow	
32564	TRAD single head - purple	
32558	TRAD single head - dark green	
32565	TRAD double head - black	
32566	TRAD double head - red	
32567	TRAD double head - blue	
32568	TRAD double head - dark green	
32678	Diaphragm Ø 44 mm - spare	

COVERS FOR STETHO

code	COVERS FOR STETHOSCOPES*	
32653	Pig cover for stethoscopes	
32654	Dragon cover for stethoscopes	
32652	Cow cover for stethoscopes	

*For pediatric applications, fits every kind of stethoscopes. Other shapes available for quantitative



SPARE PARTS AND ACCESSORIES FOR STETHOSCOPES

code	QUALITY "Y" TUBING	Minimum order
32620	"Y" tubing mixed colours	box of 20
32621	"Y" tubing - black	box of 20
32622	"Y" tubing - green	box of 20
32623	"Y" tubing - blue	box of 20
32624	"Y" tubing - red	box of 20
32625	"Y" tubing - orange	box of 20
32626	"Y" tubing - light blue	box of 20
32627	"Y" tubing - yellow	box of 20
32628	"Y" tubing - purple	box of 20
32629	"Y" tubing - pink	box of 20
32645	"Y" tubing - other colours on request*	box of 20

*Over 20 colours available: frosted green/lilac/blue/mell/pink, lavender, teal, ice blue, grey,...

BINAURAL - DIAPHRAGM - HEADS		
32655	One head chest piece - black ring	10 pcs.
32656	Dual head chest piece - black ring	10 pcs.
32665	SNOWDEN binaural - folding	10 pcs.
32666	BERTA binaural - fixed	1
32678	Diaphragm Ø 45mm for Classic adult	10 pcs.

EARTIPS AND ADAPTORS		
32659	Standard eartips - rigid - universal	10 pieces
32663	Mushroom eartips - universal	10 pieces
32664	Rigid eartips screw-type - for Classic, Wan, Yton, Duca, Regalite	10 pieces
32660	Male-female adaptor	10 pieces



WAN STETHOSCOPES - ADULT



WAN ADULT STETHOSCOPES

Features a chrome-plated zinc-alloy chestpiece, a screw-on plastic retaining ring, outer spring binaural and colour matched moulded PVC tubing with non-chill ring. Assure optimum acoustic performances. Chestpiece: \varnothing 45 mm, bell \varnothing 30 mm. Tubing: length 63 cm, int. \varnothing 4.2 mm, ext. \varnothing 8 mm. Supplied in a cardboard box. Manual and box in 11 languages: GB, FR, IT, ES, DE, PT, GR, PL, HU, SE, Arabic.

code	WAN STETHOSCOPES - LATEX FREE	
32569	WAN single head adult - black	■
32570	WAN single head adult - blue	■
32571	WAN single head adult - burgundy	■
32572	WAN single head adult - orange	■
32574	WAN double head adult - black	■
32575	WAN double head adult - blue	■
32576	WAN double head adult - burgundy	■
32577	WAN double head adult - orange	■
32678	Diaphragm \varnothing 44 mm - spare	

PEDIATRIC-NEONATAL STETHOSCOPES



WAN PEDIATRIC AND NEONATAL STETHOSCOPES:

Features a chrome-plated zinc-alloy chestpiece, a screw-on plastic retaining ring, outer spring binaural and colour matched moulded PVC tubing with non-chill ring. Assure optimum acoustic performances. Chestpiece: \varnothing 35 mm, bell \varnothing 30 mm, (pediatric) or \varnothing 22 mm, bell \varnothing 19 mm (neonatal). Tubing length: 63 cm. Supplied in a cardboard box. Manual and box in 11 languages: GB, FR, IT, ES, DE, PT, GR, PL, HU, SE, Arabic.

WAN PLUS:

Same as standard with inner spring binaural, superior tubing quality and 2 pair of soft colour coordinated ear tips in different size.

code	WAN STETHOSCOPES - LATEX FREE	
32508	WAN double head neonatal - red	■
32509	WAN double head neonatal - grey	■
32513	WAN double head pediatric - light-blue	■
32515	WAN double head pediatric - red	■
32511	WAN PLUS double head pediatric - pink	■
32506	WAN PLUS double head pediatric - black	■

DESIGN STETHOSCOPES



- 32527 DESIGN STETHO - transparent blue
- 32528 DESIGN STETHO - transparent purple

High quality single head stethoscope with fashionable design diaphragm and "Superflex TM" binaural. Provides high acoustic performances thanks to its quality components. Head and tube are in transparent coordinated colour.

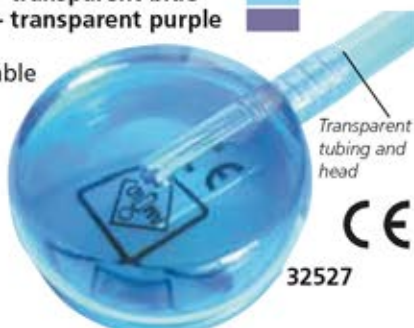

YTON STETHOSCOPES

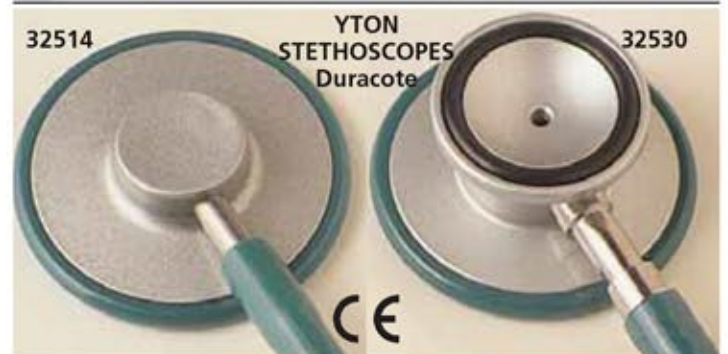

YTON STETHOSCOPES:

Chestpiece \varnothing 45 mm, bell \varnothing 30 mm (for double head), with colour coordinated plastic retaining ring. "Duracote" finished. Supplied in cardboard box. Manual and box in 11 languages: GB, FR, IT, DE, ES, PT, GR, PL, SE, HU, Arabic.

code	YTON STETHOSCOPES - LATEX FREE	
32514	Yton single head - green teal colour	■
32530	Yton double head - green teal colour	■



JOTARAP STETHOSCOPE: DOUBLE-HEAD, DOUBLE TUBE



Gima Sprague Rappaport type double-head, double-tube, latex free stethoscope at the price of a standard stethoscope. **5 in 1, five way convertible type stethoscope**
This convertible stetho, zinc alloy treaded with chrome plated chestpiece drum fitting with different sized chestpieces bells, provides versatile acoustics for infants and adults for the detection of a wide range of heart and lung sounds.

code	JOTARAP STETHOSCOPE	
32579	JOTARAP - purple	
32580	JOTARAP - black	
32581	JOTARAP - blue	
32582	JOTARAP - neon orange	
32583	JOTARAP - green	
32584	JOTARAP - neon yellow	
32585	JOTARAP - light blue	
32586	JOTARAP - fuchsia	
32587	JOTARAP - transparent pink	
32590	ACCESSORY KIT - spare	

Chestpiece with small and large diaphragm. **Double tubing for individual sound transmission**

Two separate 56 cm (22") thick latex free wall tubing provide individual sound transmission from chestpiece to both sides of the ear. **Complete in cardboard box with accessory kit (32590)**

It is supplied with an accessory pouch containing: 3 interchangeable plastic black non-chill bells, adult and pediatric spare diaphragm, one pair clear neoprene eartips, one pair black mushroom eartips. 10 languages manual (GB, FR, DE, IT, ES, PT, GR, PL, HU, Arabic).

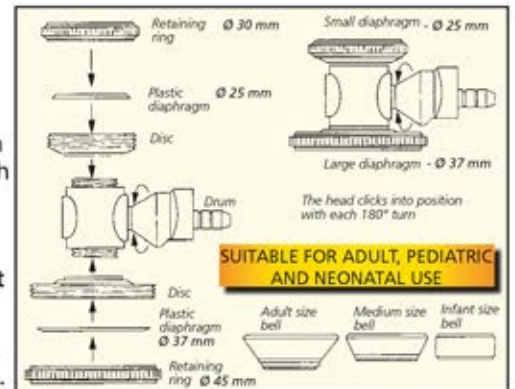

LINUX STETHOSCOPES

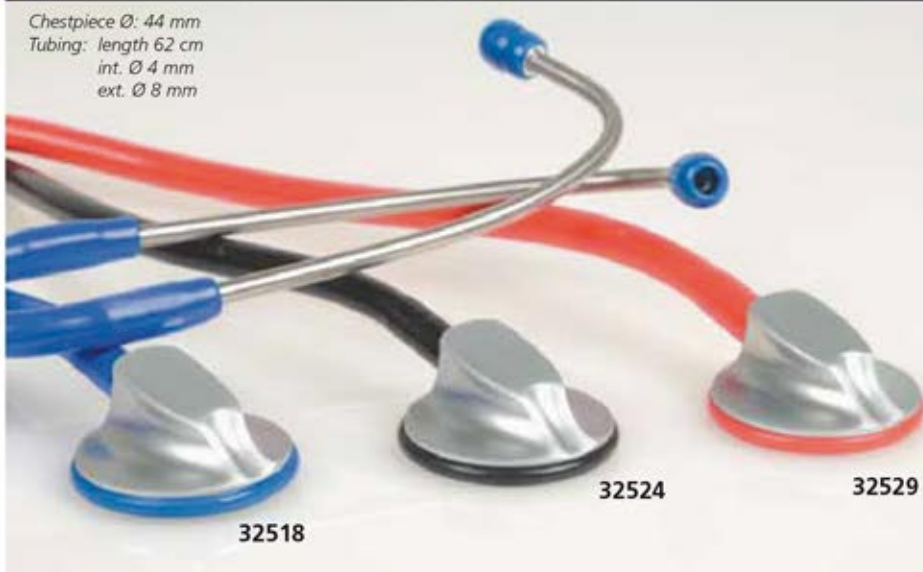

- 32518 LINUX STETHOSCOPE - blue
- 32524 LINUX STETHOSCOPE - black
- 32529 LINUX STETHOSCOPE - red

Single head stethoscope with lightweight zinc alloy chestpiece plated with an attractive satin finish. The special design assures better performances by pushing the back of the head.

Non-chill diaphragm retaining rim for patient comfort. Stainless steel binaurals fixed at 15° angle for greater comfort and acoustic seal. Soft and flexible PVC tubing. Supplied in deluxe box with one pair of plastic eartips and PVC eartips. Manual and box in 11 languages: GB, FR, IT, ES, DE, PT, GR, PL, HU, SE, Arabic.



CARDIOLOGY STETHOSCOPES

- 32550 CARDIOLOGY CLASSIC STETHOSCOPE - blue
- 32551 CARDIOLOGY CLASSIC STETHOSCOPE - burgundy
- 32552 CARDIOLOGY CLASSIC STETHOSCOPE - black

Cardiology Classic offers acoustical excellence in a traditional design with superior durability. Its innovative features include:

- stainless steel chestpiece (diameter 33-44 mm) with extra deep cone-shaped bell for a superb low frequency response
- stainless steel double inner spring binaural
- ultra-sensitive diaphragm for unsurpassed amplification
- durable, elegantly moulded 55.5 cm (22") PVC tubing (int. Ø 6.5 mm, ext. Ø 12 mm)

Manual and box in 11 languages: GB, FR, DE, IT, ES, PT, GR, PL, HU, SE, Arabic.



It comes in a foam lined box with 2 extra set of PVC eartips

- 32678 DIAPHRAGM Ø 44 mm - spare

Colour coordinated non-chill ring and diaphragm retaining ring, PVC tubing



32552

PROFESSIONAL STETHOSCOPE

- 32526 REGALITE - black
- Top quality single head stethoscope. Patented multi-frequency "ring-o-raised™" diaphragm system. Chromed plated chestpiece with "SUPERFLEX" inner spring binaural and 1 piece moulded, latex free, PVC tubing. Supplied in deluxe box, with spare soft eartips and one spare diaphragm. Manual and box in 7 languages: GB, FR, IT, ES, PT, GR, Arabic.



32526

LYNX MULTI-FUNCTIONAL VISUAL STETHOSCOPE

- 32596 LYNX MULTI-FUNCTION STETHOSCOPE with SpO₂ probe, USB cable and adapter
 - 32598 SpO₂ PROBE - spare
- Multi-function visual stethoscope with real time display of ECG waveform, heart rate and pulseoximeter.
- compact and portable, easy to use
 - adjustable screen contrast
 - adult SpO₂ sensor
 - alarm function for SpO₂ and Pulse rate
 - low power consumption
- Multilanguage box and manual: GB, FR, IT, ES



32596

TECHNICAL SPECIFICATIONS

Heart rate	Measurement range: 30 - 300 bpm	SpO₂	Measurement range: 0% - 100%
Accuracy:	±2 bpm	Accuracy:	70% - 100% ±2%, <70% unspecified
Pulse rate	Measurement range: 30 - 250 bpm	Other	
Accuracy:	±2 bpm or ±2% (select larger)	Power supply:	Rechargeable lithium battery DC 3.7 V
		Display:	2.7" LCD
		Size:	87x63x19 mm

MULTI-FUNCTIONAL VISUAL STETHOSCOPE

- 32597 MULTI-FUNCTION VISUAL STETHOSCOPE with SpO₂ probe, USB cable and adapter, earphone
 - 32598 SpO₂ PROBE - spare
- The device includes stethoscope function and displays ECG waveform, heart rate, SpO₂, pulse and pulse waveform. Suitable for hospital, clinic, medical community and family.
- compact, light and portable, easy to use
 - earphone output and adjustable volume
 - alarm for SpO₂ and pulse rate exceeding limits
 - real-time detecting, data storage and review
 - real-time clock
 - recorded data can be transferred to PC
 - PC analysis software
 - low power consumption
- Multilanguage box and manual: GB, FR, IT, ES



32597



TECHNICAL SPECIFICATIONS

Stethoscope	Heart: 20 - 230 Hz	Pulse rate	Measuring range: 30 - 250 bpm	Other	Battery: 3.7 V rechargeable lithium battery
Lung: 100 - 800 Hz	H&L: 20 - 800 Hz	Accuracy:	±2 bpm or ±2% (select larger)	Display:	2.4" colour TFT
Heart rate	Measuring range: 30 - 300 bpm	SpO₂	Measuring range: 0% - 100%	Size:	110x60x14 mm
Accuracy:	±2 bpm	Accuracy:	70 - 100% (±2%) <70% unspecified		

ACOUSTIC EXCELLENCE DOUBLE HEAD STETHOSCOPES



CLASSIC STAINLESS STEEL STETHOSCOPES - Adult and Pediatric
 High quality stethoscope with stainless steel chestpiece, stainless steel double inner spring binaural and durable, elegantly moulded PVC tubing for unsurpassed acoustic performance. The colour coordinated flexible 55 cm (22") PVC "Y" tubing, non-chill ring and diaphragm retaining ring provide excellent patient comfort, while adding attractiveness. It comes in a foam lined box with 2 extra sets of soft eartips. Chestpiece: Ø 45 mm (adult), Ø 35 mm (pediatric). Manual and box in: GB, FR, DE, IT, ES, PT, GR, PL, HU, SE, Arabic.

CLASSIC IN 11 COLOURS



code	ACCESSORIES - SPARES
32678	Diaphragm Ø 44 mm - spare for Classic adult
32664	Rigid eartips screw-type - white spare for Classic/Wan/Yton/Duca/Regalite

code	CLASSIC DOUBLE HEAD S/S STETHOSCOPES - ADULT
32531	Classic adult - dark green
32532	Classic adult - orange
32533	Classic adult - light blue
32534	Classic adult - black
32535	Classic adult - burgundy
32536	Classic adult - dark blue
32537	Classic adult - green
32538	Classic adult - red
32539	Classic adult - pink
32540	Classic adult - royal blue
32541	Classic adult - lilac

code	CLASSIC DOUBLE HEAD S/S TEACHING STETHOSCOPES
32542	Classic Teaching - black <i>allows simultaneously auscultation by 2 people</i>

code	CLASSIC DOUBLE HEAD S/S STETHOSCOPES - PEDIATRIC
32512	Classic pediatric - light-blue
32516	Classic pediatric - black



RIESTER DUPLEX® 2.0 STETHOSCOPES, SIMPLY BETTER HEARING



RIESTER DUPLEX® 2.0 STAINLESS STEEL STHETOSCOPES
 Duplex® 2.0 stethoscopes are distinguished by outstanding acoustic performance.

They have been completely new constructed to meet the challenges of daily diagnostic practice. Special design tube for better auscultation of adults, children/babies or new-borns.

- precision double chest-piece made of stainless steel with innovative membrane support
- anatomically shaped binaural with internal multiple spring for adjusting the contact pressure
- extra-soft, replaceable and pivotable ear-tips for perfect sealing at the ear canal and enhanced wear comfort
- innovative acoustic system with extraordinary auscultation for all frequency ranges

- special membrane for precise acoustics with novel non-chill rims for improved adaptation on the skin
 Supplied with name plate, replacement ear-tips and membrane.

code	Riester code	RIESTER DUPLEX® 2.0 - STAINLESS STEEL - LATEX FREE	Membrane	Length	Weight
32333	4210-01	Duplex® 2.0 - black	Ø 44 mm	74 cm	151 g
32334	4210-02	Duplex® 2.0 - white	Ø 44 mm	74 cm	151 g
32335	4210-03	Duplex® 2.0 - blue	Ø 44 mm	74 cm	151 g
32336	4210-04	Duplex® 2.0 - red	Ø 44 mm	74 cm	151 g
DUPLEX® 2.0 PEDIATRIC					
32338	4220-02	Duplex® 2.0 - white	Ø 32/23.5 mm	69 cm	124 g
DUPLEX® 2.0 NEW-BORN					
32340	4230-02	Duplex® 2.0 - white	Ø 24/17.5 mm	69 cm	105 g

ERKA FINESSE STETHOSCOPES - MADE IN GERMANY



FINESSE STETHOSCOPES

With the reversible double chest-piece you'll be prepared for all eventualities in everyday medical practice. The membrane side guarantees optimal auscultation for the entire frequency spectrum and the open bell side is specifically designed for low frequencies.

FINESSE² STETHOSCOPES

The reversible, combined chest-piece has two membrane sides, each making the full frequency range perfectly audible. The large membrane is suitable for auscultation of adults and the small one for children or slim patients.

All Erka stethoscopes are supplied with carrying bag



FEATURES	Finesse Light	Finesse Finesse ²
Pre-tensioned ERKA. convex membrane provides excellent resonance and sound.	X	X
Non-chill ring ensures highest patient comfort.		X
Superior polish, chromium-plated, non-porous surface and brass chest-piece ensure perfect surface hygiene.	X	X
Two internal channels run parallel in the stethoscope tubing preventing any noise caused by friction of two separate tubes.		X
Through the separately integrated spring in the tube, there is no acoustic loss from the chest-piece to the ear.		X
Ergonomic design and super soft tips provide excellent acoustic seal against external noise interference and maximize user's comfort.	X	X
Standard 15° inclined binaurals can be individually adapted to the specific ear canal of the user.	X	X

code	ERKA code	ERKA STETHOSCOPES - tubing length - 55 cm
FINESSE LIGHT ADULT - head Ø 44.5/33.5 mm		
32250	520 000 00	■ Finesse light - black
32251	520 000 20	■ Finesse light - navy blue
32252	520 000 55	■ Finesse light - dark green
FINESSE PEDIATRIC - head Ø 31/26.5 mm		
32256	549 000 00	■ Finesse pediatric - black
32257	549 000 25	■ Finesse pediatric - light blue
32258	549 000 35	■ Finesse pediatric - pink
FINESSE ADULT - head Ø 44.5/33.5 mm		
32262	550 000 00	■ Finesse adult - black
32263	550 000 05	■ Finesse adult - dark grey
32264	550 000 20	■ Finesse adult - navy blue
32265	550 000 55	■ Finesse adult - dark green
32266	550 000 60	■ Finesse adult - burgundy
FINESSE² PEDIATRIC - head Ø 30/21.3 mm		
32270	536 000 00	■ Finesse ² pediatric - black
32271	536 000 35	■ Finesse ² pediatric - pink
FINESSE² ADULT - head Ø 47/30 mm		
32275	535 000 00	■ Finesse ² adult - black
32276	535 000 05	■ Finesse ² adult - dark grey
32277	535 000 20	■ Finesse ² adult - navy blue

ERKAPHON STETHOSCOPES - MADE IN GERMANY



Stethoscope with double chest piece is switchable from membrane to bell function. The membrane side is suitable for the auscultation of high and low frequency sounds while the bell side is designed for cardiac impulses.

ERKAPHON STETHOSCOPES:

High quality precision stethoscopes for excellent acoustics, made in Germany.

All stethoscopes are equipped with 56 cm long Y tube, brass chrome-plated binaural and chest-piece (32350, 32358) or aluminium (32344-7), membrane Ø 44 mm, bell Ø 30 mm (32358 only).

code	ERKA code	ERKAPHON STETHOSCOPES
ERKAPHON FLAT CHESTPIECE - aluminium		
32344	544 000 10	Erkaphon flat chestpiece - black
32345	544 000 20	Erkaphon flat chestpiece - navy blue
32346	544 000 25	Erkaphon flat chestpiece - light blue
32347	544 000 30	Erkaphon flat chestpiece - red
ERKAPHON FLAT CHESTPIECE - chromed		
32350	543 000 10	Erkaphon flat chestpiece - black
ERKAPHON DOUBLE CHESTPIECE - chromed		
32358	541 000 10	Erkaphon double chestpiece - black

3M™ LITTMANN® STETHOSCOPES USER GUIDE

LITTMANN STETHOSCOPES

3M Littmann stethoscopes offer exceptional acoustic features. Each model has been created for a specific professional need.

The following guide will allow customers to select the model more suitable to his profession and preferred colour.

OCCUPATION	Lightweight		Classic				Cardiology			Electronic
	Lightweight	Select	Master Classic II	Classic III	Classic II SE	Classic II Paediatric or Infant	Master Cardiology	Cardiology IV	Cardiology III	3200 3100
Emergency Physician			••	•••	••					
General Practitioner			••	•••	••					•••
Pediatrician			••	•••	••	••				
Medical Student			••	•••	••					
Veterinarian			••	•••	••					
Neurologist			••	•••	••					
Nurse	••	••		•	•					
Cardiologist							••	••	••	•••
Anesthesist							•	••	••	•••
Respiratory Specialist							•	••	••	•••
Internist							•	•	•	•••



3M™ LITTMANN® SELECT

The 3M Littmann® Select Stethoscope is ideal for general examination purposes, including blood pressure measurement. The patented single-sided chestpiece for both low and high frequency sounds offers acoustic clarity.

Head Ø 44 mm

32400



3M™ LITTMANN® LIGHTWEIGHT II

Authorized Distributor

Standard length 71 cm

Lightweight only 118 g

Headset made of aerospace alloy

32391



Tunable diaphragm for easy low and high frequency monitoring

code	3M code	3M™ LITTMANN® SELECT STETHOSCOPES - length 71 cm
32397	2292	• Littmann® Select - pearl pink
32398	2294	• Littmann® Select - violet
32399	2306	• Littmann® Select - ocean blue
32400	2298	• Littmann® Select - royal blue
32401	2293	• Littmann® Select - burgundy
32403	2290	• Littmann® Select - black
32282	2291	• Littmann® Select - caribbean blue
32283	2296	• Littmann® Select - raspberry
32396		Littmann® Select - colour on request*

*Minimum order 3 pieces

code	3M code	3M™ LITTMANN® LIGHTWEIGHT II S.E.
32389	2452	• Littmann® Lightweight II S.E. - caribbean blue
32390	2450	• Littmann® Lightweight II S.E. - black
32391	2451	• Littmann® Lightweight II S.E. - burgundy
32392	2454	• Littmann® Lightweight II S.E. - ceil blue
32393	2453	• Littmann® Lightweight II S.E. - lilac
32394	2455	• Littmann® Lightweight II S.E. - metal green
32395		Littmann® Lightweight II S.E. - colour on request*

*Minimum order 3 pieces

3M™ LITTMANN® MASTER CLASSIC II

OTHER COLOURS ON REQUEST AVAILABLE IN 20 DAYS



MASTER CLASSIC II



MASTER CLASSIC II BLACK EDITION

code	3M code	3M™ LITTMANN® MASTER CLASSIC STETHOSCOPES length 69 cm - head Ø 44 mm
32425	2146	• Littmann® Master Classic II - burgundy
32426	2144L	• Littmann® Master Classic II - black
32427	2147	• Littmann® Master Classic II - navy blue
32364	2630	• Littmann® Master Classic II - caribbean blue
32366	2633	• Littmann® Master Classic II - ceil blue
32367	2632	• Littmann® Master Classic II - violet
32471	2141	• Littmann® Master Classic II - "black edition"
32365		Littmann® Master Classic II - colour on request

3M™ LITTMANN® CLASSIC III STETHOSCOPES



The 3M™ Littmann® Classic III™ Stethoscope offers high acoustic sensitivity for exceptional performance when doing general physical assessments.

It features dual tunable diaphragms and updated design.

- high acoustic sensitivity
- dual single-piece tunable diaphragms (pressure sensitive)
- versatile adult and pediatric two-sides chestpiece
- small-side diaphragm prevents debris in open bell
- snap tight soft-sealing eartips
- next generation longer-life tubing
- small side converts to open bell



Authorized Distributor

CLASSIC III - RASPBERRY - RAINBOW FINISH

code	3M code	3M™ LITTMANN® STETHOSCOPES - length 69 cm
CLASSIC III - head Ø 43/33 mm		
32290	5620	■ Littmann® Classic III - black
32291	5622	■ Littmann® Classic III - navy blue
32292	5626	■ Littmann® Classic III - raspberry
32293	5627	■ Littmann® Classic III - burgundy
32294	5639	■ Littmann® Classic III - rose pink
32295	5832	■ Littmann® Classic III - lavender
32296	5835	■ Littmann® Classic III - turquoise
32297	5839	■ Littmann® Classic III - lemon - lime
32298	5840	■ Littmann® Classic III - emerald
32299	5621	■ Littmann® Classic III - grey
32300	5623	■ Littmann® Classic III - caribbean blue
32301	5624	■ Littmann® Classic III - hunter green
32302	5629	■ Littmann® Classic III - orange
32303	5630	■ Littmann® Classic III - ceil blue
32304	5633	■ Littmann® Classic III - pearl pink
32305	5829	■ Littmann® Classic III - lime green
32306	5831	■ Littmann® Classic III - plum
CLASSIC III SPECIAL EDITION - head Ø 43/33 mm		
32308	5870	■ Littmann® Classic III - black - rainbow finish
32309	5871	■ Littmann® Classic III - raspberry - smoke finish
32310	5803	■ Littmann® Classic III - black edition
32311	5809	■ Littmann® Classic III - chocolate - copper finish
32312	5806	■ Littmann® Classic III - raspberry - rainbow finish
32313	5807	■ Littmann® Classic III - caribbean blue - rainbow finish
32314	5811	■ Littmann® Classic III - black - smoke finish
32315	5812	■ Littmann® Classic III - dark olive green - smoke finish
32316	5867	■ Littmann® Classic III - navy blue - black finish
32317	5868	■ Littmann® Classic III - burgundy - black finish
32318	5869	■ Littmann® Classic III - caribbean blue - black finish



3M™ LITTMANN® CLASSIC II STETHOSCOPES



OTHER COLOURS ON REQUEST
Available in 20 days
Please indicate 3M code

*Minimum order 3 pieces

CLASSIC II INFANT



CLASSIC II PEDIATRIC



CLASSIC II SE



CLASSIC II SE SPECIAL FINISH



code	3M code	3M™ LITTMANN® STETHOSCOPES - length 71 cm
CLASSIC II PEDIATRIC - head Ø 33/25 mm		
32382	2115	■ Littmann® Classic II ped. - pearl pink
32383	2155	■ Littmann® Classic II ped. - orange
32384	2136	■ Littmann® Classic II ped. - royal blue
32385	2123	■ Littmann® Classic II ped. - navy blue
32386	2131	■ Littmann® Classic II ped. - pine green
32404	2113	■ Littmann® Classic II ped. - black
32405	2119	■ Littmann® Classic II ped. - caribbean blue
32406	2113R	■ Littmann® Classic II ped. - red
32407	2122	■ Littmann® Classic II ped. - raspberry
32408	2154	■ Littmann® Classic II ped. - peach
32381	2153	■ Littmann® Classic II ped. - caribbean blue - rainbow finish
32387		■ Littmann® Classic II ped. - colour on request*
CLASSIC II INFANT - head Ø 27/19 mm		
32376	2124	■ Littmann® Classic II infant - caribbean blue
32410	2114	■ Littmann® Classic II infant - black
32411	2114R	■ Littmann® Classic II infant - red
32412	2125	■ Littmann® Classic II infant - raspberry
32380	2157	■ Littmann® Classic II infant - raspberry - rainbow finish
32377	2156	■ Littmann® Classic II infant - royal blue
32378	2179	■ Littmann® Classic II infant - orange
32379	2120	■ Littmann® Classic II infant - pearl pink
32375		■ Littmann® Classic II infant - colour on request*
CLASSIC II S.E. ADULT - head Ø 44/32 mm		
32413	2210	■ Littmann® Classic II S.E. - raspberry
32415	2201	■ Littmann® Classic II S.E. - black
32416	2205	■ Littmann® Classic II S.E. - navy blue
32419	2211	■ Littmann® Classic II S.E. - burgundy
32421	2813	■ Littmann® Classic II S.E. - ceil blue
32481	2822	■ Littmann® Classic II S.E. - peach
32483	2817	■ Littmann® Classic II S.E. - bubblegum - pink
CLASSIC II S.E. SPECIAL FINISH - head Ø 44/32 mm		
32470	2218BE	■ Littmann® Classic II S.E. - black edition

3M™ LITTMANN® CARDIOLOGY IV STETHOSCOPES



The 3M™ Littmann® Cardiology IV helps you to catch more of the subtle critical sounds, thanks to the improved acoustics and the new design, more versatile than ever.

- better audibility of high-frequency sounds
- tunable diaphragms for hearing both high and low frequency sounds without turning over the chestpiece (pressure sensitive)
- adult and paediatric sides for more versatility
- single-piece diaphragm, easier to attach and clean, because the surface is smooth without crevices
- next generation longer-life tubing
- snap tight soft-sealing eartips.



code	3M code	3M™ LITTMANN® STETHOSCOPES - length 69 cm
CARDIOLOGY IV - head Ø 43/33 mm		
32606	6152	■ Littmann® Cardiology IV - black
32607	6153	■ Littmann® Cardiology IV - burgundy
32608	6154	■ Littmann® Cardiology IV - navy blue
32609	6155	■ Littmann® Cardiology IV - hunter green
32610	6156	■ Littmann® Cardiology IV - plum
32611	6157	■ Littmann® Cardiology IV - caribbean blue
32612	6158	■ Littmann® Cardiology IV - raspberry
32613	6161	■ Littmann® Cardiology IV - rose pink

code	3M code	3M™ LITTMANN® STETHOSCOPES - length 69 cm
CARDIOLOGY IV SPECIAL FINISHES - head Ø 43/33 mm		
32631	6162	■ Littmann® Cardiology IV - black - smoke finish
32632	6163	■ Littmann® Cardiology IV - black edition
32633	6164	■ Littmann® Cardiology IV - black - brass finish
32634	6165	■ Littmann® Cardiology IV - black - rainbow finish
32635	6166	■ Littmann® Cardiology IV - plum - smoke finish
32636	6168	■ Littmann® Cardiology IV - navy blue - black finish
32637	6171	■ Littmann® Cardiology IV - turquoise - smoke finish
32638	6178	■ Littmann® Cardiology IV - raspberry - smoke finish
CARDIOLOGY IV MIRROR FINISH - head Ø 43/33 mm		
32646	6169	■ Littmann® Cardiology IV - caribbean blue - mirror fin.
32647	6170	■ Littmann® Cardiology IV - burgundy - mirror finish
32648	6177	■ Littmann® Cardiology IV - black - mirror finish
32649	6179	■ Littmann® Cardiology IV - black/champagne - smoke fin.

3M™ LITTMANN® CARDIOLOGY STETHOSCOPES



CARDIOLOGY III



CARDIOLOGY III BLACK EDITION



MASTER CARDIOLOGY

code	3M code	3M™ LITTMANN® STETHOSCOPES - length 69 cm
CARDIOLOGY III - head Ø 43/33 mm		
32371	3138	■ Littmann® Cardiology III - caribbean blue
32372	3148	■ Littmann® Cardiology III - raspberry
32429	3149	■ Littmann® Cardiology III - coral pink
32430	3128	■ Littmann® Cardiology III - black
32431	3129	■ Littmann® Cardiology III - burgundy
32432	3130	■ Littmann® Cardiology III - navy blue
32433	3135	■ Littmann® Cardiology III - plum
32434	3134	■ Littmann® Cardiology III - hunter green
32443	3146	■ Littmann® Cardiology III - light blue
32444	3140	■ Littmann® Cardiology III - red
CARDIOLOGY III SPECIAL EDITION - head Ø 43/33 mm		
32369	3161	■ Littmann® Cardiology III - lime - smoke finish
32472	3131BE	■ Littmann® Cardiology III - black edition
32474	3137CPR	■ Littmann® Cardiology III - chocolate - copper finish
32475	3128BRS	■ Littmann® Cardiology III - black - brass finish
32373	3152RBW	■ Littmann® Cardiology III - black - rainbow finish

code	3M code	3M™ LITTMANN® STETHOSCOPES - length 69 cm
MASTER CARDIOLOGY - head Ø 51 mm		
32435	2160	■ Littmann® Master Cardiology - black
32436	2163	■ Littmann® Master Cardiology - burgundy
32437	2164	■ Littmann® Master Cardiology - navy blue
32439	2167	■ Littmann® Master Cardiology - plum
32361	2178	■ Littmann® Master Cardiology - caribbean blue
32362		■ Littmann® Master Cardiology - colour on request
MASTER CARDIOLOGY SPECIAL EDITION - head Ø 51 mm		
32360	2176	■ Littmann® Master Cardiology - black smoke ed.
32473	2161	■ Littmann® Master Cardiology - black edition
32363	2183	■ Littmann® Master Cardiology - hunter green brown finish
32359		■ Littmann® Master Cardiology - colour on request
CARDIOLOGY TRADITIONAL		
32330	3141	■ Littmann® Traditional - black
32331	3142	■ Littmann® Traditional - navy blue
32332	3143	■ Littmann® Traditional - burgundy



CARDIOLOGY III



CARDIOLOGY III BLACK EDITION



CARDIOLOGY III COPPER FINISH



MASTER CARDIOLOGY



MASTER CARDIOLOGY BLACK EDITION



CARDIOLOGY TRADITIONAL

3M™ LITTMANN® 3100 AND 3200 ELECTRONIC STETHOSCOPES

ELECTRONIC STETHOSCOPES

3M™ Littmann® Electronic Stethoscope Model 3100 and 3200 exceptional sound capabilities deliver an exceptional auscultation experience. Clinical evidence shows that, it is easier to detect difficult-to-hear heart sounds like S3 gallops and aortic regurgitation murmurs, as well as abnormal lung sounds. Here's why:

Ambient Noise Reduction Technology

It cancels out, on average, 85% of ambient background noise that can interfere with the auscultation experience, without eliminating critical body sounds.

Acoustic Seal Eartips and Tubing

They create an excellent acoustic seal. It means a tighter seal from ambient noise entering through tubing and eartip connections.

State-of-the-Art Sound Sensor

Positioned at the base of the tubing, the sensor brings the sound more naturally to your ears.

Up to 24X Sound Amplification

Useful for obese



Ergonomically designed chest piece for easy, one-hand manipulation and patient comfort

LITTMANN® 3200 ELECTRONIC

Designed to visualize what you are hearing, allow playback when and where convenient, facilitate storage of sounds in patient records or transfer to colleagues for further analysis.

- connects wirelessly to the Bluetooth®
- display and print sounds as phonocardiogram
- play recordings at slow speed
- save patient information
- send as an e-mail attachment



3M Littmann® Stethoscopes

32495

Authorized Distributor

code	3M code	3M™ LITTMANN® ELECTRONIC STETHOSCOPES
32490	3100BK27	■ Littmann® Electronic 3100 - black
32491	3100BU	■ Littmann® Electronic 3100 - burgundy
32492	3100NB	■ Littmann® Electronic 3100 - navy blue
32495	3200BK27	■ Littmann® Electronic 3200 - black
32496	3200NB	■ Littmann® Electronic 3200 - navy blue
32497	3200BU	■ Littmann® Electronic 3200 - burgundy

3M™ LITTMANN® ACCESSORIES

code	3M code	3M™ LITTMANN® ACCESSORIES
DIAPHRAGM + RETAINING RING - box of 5 pcs		
32449	36572	■ For Cardiology III (small side) - black
51443	36573	■ For Cardiology III (small side) - grey
32450	36556	■ For Classic II S.E., Select, Master classic, Cardio III (large side) - black
32464	36557	■ For Classic II S.E., Select, Master classic, Cardio III (large side) - grey
32452	36554	■ For Master Cardiology - black
32605	36555	■ For Master Cardiology - grey
32453	51185	■ For S.T.C. Cardiology - black
DIAPHRAGM OR RETAINING RINGS		
51450	36550	■ Retaining ring for Pediatric Classic II - black - box of 5
51451	36551	■ Retaining ring for Pediatric Classic II - grey - box of 5
51445	MEMB/E3200	■ Diaphragm for Electronic 3200 - black
32454	MEMB/E3100	■ Diaphragm for Electronic 3100 - dark grey
32478	78808303222	■ Diaphragm for Electronic 3000 - dark grey
51452	36560	■ Diaphragm for Pediatric Classic II - box of 10
NEOPRENE RINGS		
32476	36547	■ Neoprene black ring - infant - box of 5
32455	36569	■ Neoprene grey ring - infant - box of 5
51455	36546	■ Neoprene black ring - pediatric - box of 5
32456	36568	■ Neoprene grey ring - pediatric - box of 5
32459	36544	■ Neoprene black ring - Classic II, Lightweight - box of 10
51456	36545	■ Neoprene grey ring - Classic II - box of 10
EAR TIPS for all models - box of 10 pairs		
32451	37812	■ Ear Tips - grey - soft - large
32465	37809	■ Ear Tips - black - soft - small
32466	37811	■ Ear Tips - black - soft - large
32467	38742	■ Ear Tips - grey - rigid - small
32468	37808	■ Ear Tips - grey - rigid - large
51490	40001	■ Ear Tips - black - small and large
51491	40002	■ Ear Tips - grey - small and large
32460	BLCIP/N	■ Binaural Classic II SE, ped., infant, Select - black
32461	BLCAR/N	■ Binaural Cardiology III and Master Cardiology - black
32462	BMACL/N	■ Binaural Master Classic, Classic III - black
32469	2170	■ Name tag - black
51494	40007	■ Name tag - black
51495	40008	■ Name tag - grey
2 TUNABLE DIAPHRAGMS AND RIM ASSEMBLY + NON CHILL BELL SLEEVES + EARTIPS		
51460	40003	■ For Cardiology III™ - black - blister
51461	40004	■ For Cardiology III™ - grey - blister
TUNABLE DIAPHRAGM AND RIM ASSEMBLY + NON CHILL BELL SLEEVES + EARTIPS		
51464	40005	■ For Classic II S.E. - black - blister
51465	40006	■ For Classic II S.E. - grey - blister
51466	40020	■ For Lightweight - black - blister
TUNABLE DIAPHRAGM + RIM ASSEMBLY + EARTIPS		
51470	40011	■ For Master Cardiology - black - blister
51471	40018	■ For Master Cardiology - grey - blister
51472	40019	■ For Cardiology S.T.C. - black - blister
51473	40022	■ For Master Classic™ - black - blister
TUNABLE DIAPHRAGM + 2 RIMS ASSEMBLY		
51477	40012	■ For Classic II™ - Paediatric - black - blister
51478	40013	■ For Classic II™ - Infant - black - blister
2 TUNABLE DIAPHRAGMS + RIM ASSEMBLY + EARTIPS		
51482	40016	■ For Classic III™ - black - blister
51483	40017	■ For Classic III™ - grey - blister



YTON ANEROID SPHYGMOMANOMETERS

YTON ANEROID SPHYGMOMANOMETERS

Economic sphygmomanometers with nylon cuff with velcro closure, reliable manometer with clip to be fixed on the cuff.

Scale 0-300 mmHg. Air release at closed tap max 4 mmHg/minute.

Manual setting of deflation possible up to 2/3 mmHg/sec.

From 260 mmHg to 15 mmHg max deflation time 10 sec.

Scale graduated every 2 mmHg.

Floating zero (the pointer has no stop point but swings freely), nylon velcro cuff, latex bulb with chromium plated valve.

Chromium-plated air tap with air release regulation by screw valve.

Supplied with a simulated-leather soft pouch with zip in a carton box.

Available in 5 versions: standard, with one piece cuff, latex free, with incorporated stethoscopes or kit (sphygmomanometer+stethoscope).

Multilanguage box and manual: GB, FR, IT, ES, PT, DE, GR, Arabic.

code	YTON SPHYGMOMANOMETERS	
32720	YTON - black cuff	■
32692	YTON - one piece cuff	■
32704	YTON latex-free - blue cuff	■
32703	YTON - with incorporated - stethoscope - black cuff	■
32693	YTON KIT - sphygmomanometer + stethoscope	■
32701	YTON MANOMETER - spare	



32703
Yton with incorporated Stethoscope



32720
Yton sphygmomanometer



ONE PIECE CUFF
LATEX FREE

CE 0476

32692



CE 0476 LATEX FREE

32704



INCORPORATED STETHOSCOPE

CE 0476

32703



LATEX FREE KIT STETHOSCOPE + SPHYGMO

CE 0476

32693

YTON DIGITAL SPHYGMO

32722 YTON DIGITAL SPHYGMO

Semi-automatic digital sphygmomanometer with manual inflation and automatic deflation through manual valve.

Light: only 50 g, one third of a normal blood pressure monitor.

A large 9 digits LCD display shows systolic/diastolic/pulse rate simultaneously, and store 90 memories.

Range: 40-260 mmHg

Pulse: 40-160 minute

Power supply: 1 x AAA battery

Multilanguage box: GB, FR, IT, ES, PT, DE, GR, Arabic.

Manual: GB, IT

Digital Yton sphygmomanometer



CE 0476

32722

SPHYGMOMANOMETERS WITH GAUGE ON THE CUFF

CE 0051

32724

CE 0051

CE 0476

Quality
linen
cuffTOP
QUALITY

Extra large dial Ø 65 mm

Extra large bulb
9x5 cm

- **32724 BERLIN SPHYGMO - velcro cuff**
High quality sphygmomanometer with gauge mounted on cuff:
 - high reliable manometer with extra large dial Ø 65 mm
 - top quality and resistant linen cuff with simulated leather support and velcro closure
 - extra large PVC bulb, 9x5 cm, latex free
 Made in Italy - German manometer



32723

ITALIAN
QUALITY

- **32723 NEW EXACTOPHON SPHYGMO - pull-on strap cuff**
GIMA quality and reliability in a stylish and long-life sphygmomanometer. EXACTOPHON has a reliable manometer fixed on a simulated leather support, on a highly resistant linen pull-on straps cuff. Supplied in a nice carrying case and box. Made in Italy: GIMA.
- **32805 EXACTOPHON BLADDER - spare**
- **32806 EXACTOPHON CUFF - spare**



ECONOMIC

LATEX FREE

32719

- **32719 GIMATONO - latex free**
Economic sphygmo with chrome-plated manometer fixed on the cuff, provided with a rubber protective ring. Nylon cuff with simulated-leather support. Two tubes adult size latex free TPU bladder, with standard latex free PVC bulb. Supplied in nylon bag and cardboard box. Made in P.R.C.

SHOCK RESISTANT SPHYGMO MINOR 2 SPHYGMO - 2 TUBES

CE 0476

ISO 81060
STANDARD3 YEARS
WARRANTY

32702

- **32702 SHOCK RESISTANT SPHYGMO - nylon-cuff**
High quality, shock resistant sphygmomanometer matching the ISO 81060 standard.
One piece design with damped system manometer
Creative design with a new structure that fixes all parts together closely to make it more steadier. The damped system absorbs impacts.
Other features
 - large dial Ø 55 mm easy to read
 - high precision air-release valve, provides precise rate adjustment and quick deflation
 - adult nylon cuff with latex-free bladder
 - soft bulb for fast inflation.
 Multilanguage box and manual: GB, FR, IT, ES, PT, DE.



32714

LATEX FREE

CE 0123

Adjustable gauge for
perfect calibration

- **32714 MINOR 2 SPHYGMO - 2 tubes - black nylon velcro cuff**
- **32713 MINOR 2 SPHYGMO - 2 tubes - green cotton hook cuff**
High quality sphygmomanometer with traditional design and modern features.
 - high precision manometer, adjustable by turning a screwdriver, for perfect calibration any time
 - 2 tubes system for quick inflation
 - Available with washable coated fabric velcro cuff or cotton hook cuff



32713

SIRIO SPHYGMO AND 3 MULTICUFF KIT WITH BAG

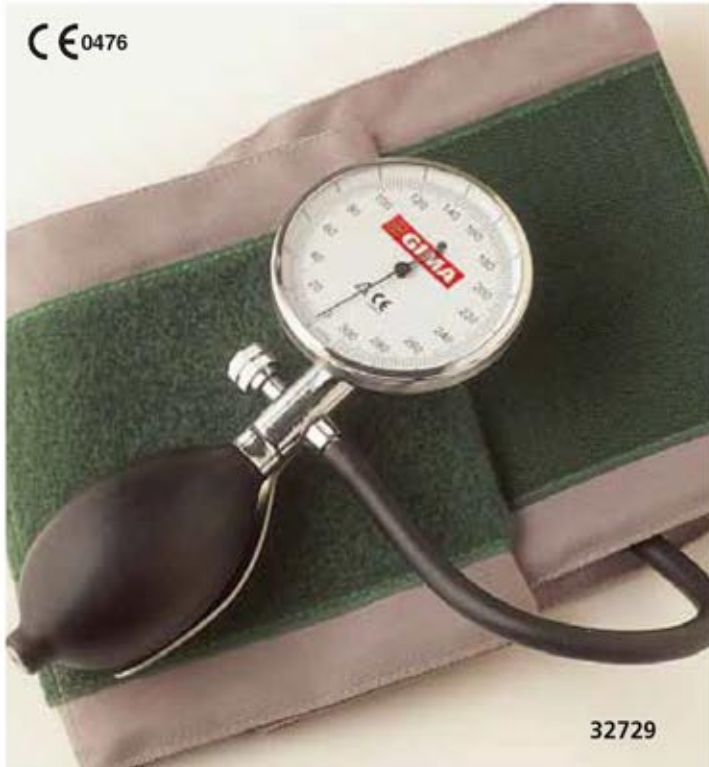

• 32729 SIRIO SPHYGMO - adult grey/green cuff
Classic sphygmomanometer with fabric cuff with velcro closure (green/grey colour). Reliable large dial manometer for easy readings, fixed on bulb. Scale 0-300 mmHg, graduated every 2 mmHg. Supplied in carrying case and box, with 4 languages user manual (English, Spanish, French, Italian).



32729

• 32705 SIRIO PEDIATRIC KIT - sphygmo with 3 pediatric cuffs
Sirio with 3 pediatric cuffs: minicuff (32812) 4 months - 3years, minicuff (32813) 3-7 years, minicuff (32814) 7-10 years in a nylon bag.
• 27177 SIRIO MULTICUFF PEDIATRIC BAG - empty



32705

• 32706 SIRIO KIT 3 - sphygmo with 3 one piece cuffs
Sirio with 3 one piece cuffs: child (32910), adult (32911) and adult large (32912) in a nylon bag.
• 27178 SIRIO MULTICUFF BAG 3 - empty



32706

• 32707 SIRIO KIT 5 - sphygmo with 5 cuffs
Sirio with 5 cuffs: infant cuff (32886), child cuff (32888), adult cuff (32830), adult large cuff (32834) thigh cuff (32837) in a nylon bag.
• 27179 SIRIO MULTICUFF BAG 5 - empty



32707

LONDON: PROFESSIONAL SPHYGMO



• 32725 LONDON SPHYGMO - adult - black cuff
• 32726 LONDON SPHYGMO - adult - red cuff
Professional, stylish, reliable and lightweight sphygmomanometer with ABS manometer, integral PVC bulb, high quality precision mechanism, velcro closure calibrated nylon cuff and one tube TPU bladder. Dial Ø 55 mm, with specially designed eye-catching colour printing and easy to read. Special outer ring protects the manometer from shocks

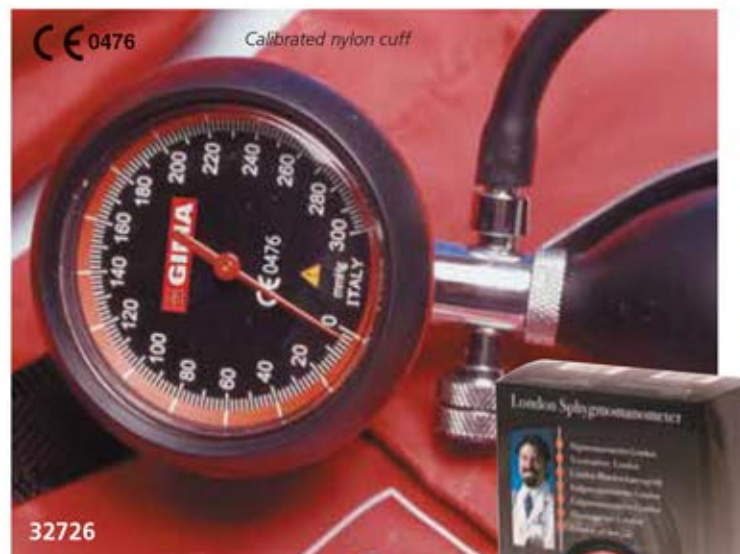

and the glass from scratches. Supplied in a nice colour co-ordinated carrying bag and box. With multilingual box and user manual: GB, FR, IT, ES, DE, PT, GR. Latex free.



32726

TOKYO AUTOMATIC

• **32735 TOKYO SPHYGMO - adult - black cuff**
Professional sphygmomanometer with large Ø 65 mm dial and **button type air release valve**. ABS light plastic case, and extra shock-proof ring for long durability.



360° rotary handle.
Supplied with black nylon calibrated cuff with D-ring, black 1-tube PVC, latex free bladder and black, latex free PVC bulb in a nylon carrying bag and cardboard box.
Multilanguage box and manual: GB, FR, IT, ES, DE, PT, GR, Arab.



CE 0476

For rapid (push) or gradual (screw) deflation



Press the button, rapid deflation



Screw the button, gradual deflation

ROMA SPHYGMOMANOMETERS - 4 DIFFERENT MODELS



CE 0476

32727

32709 Pediatric



Classic, lightweight, reliable palm model aneroid sphygmo with certified manometer ABS housing, integral PVC bulb and air release valve for one-hand use, provided with handle, blue nylon, velcro closure, calibrated cuff and 1 tube TPU bladder.

Easy to read: large dial Ø 60 mm, with rubber protective ring.

Supplied in a nice nylon carrying bag with external velcro pocket and cardboard box. Latex free.

32734 2 tubes



• **32727 ROMA SPHYGMO - adult - 1 tube**
• **32734 ROMA SPHYGMO - adult - 2 tubes**
• **32709 ROMA SPHYGMO - pediatry - 1 tube**
Same as 32727 but with pediatric cuff 35x11 cm

• **32728 ROMA SPHYGMO - adult - fluorescent - 1 tube**

Same as 32727 but with special fluorescent dial plate to allow easy reading even in dark places.

Suitable for emergency.

- **32856 PVC RIBBED BULB**
- **32857 PVC PROTECTIVE RING**

32728 Fluorescent dial plate



ROMA MULTICUFFS KIT



CE 0476

32738

• **32738 ROMA KIT - Sphygmo with 3 cuffs**
Same as code 32727 but supplied with 3 cuffs: one pediatric (35x11 cm), one adult (49x15 cm) and one adult large (62x17.5 cm). Latex free.

EMERGENCY MULTICUFF KIT

• **32771 EMERGENCY SPHYGMO KIT - 5 cuffs**
Palm type sphygmomanometer with orange silicone shockproof ring and orange cup of air-release valve. PVC tube and 1 tube TPU bladder. Supplied in a plastic carrying case with 5 cuffs: XS infant (13-19 cm), S child (18.4-26.7 cm), M adult (25.4-40.6 cm), L adult large (33.3-51 cm), XL thigh (40.6-66 cm)

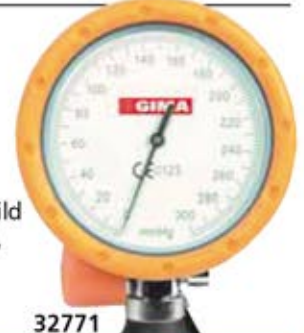

32771



CE 0123

CUFFS ASSORTMENT FROM NEWBORN TO OBESE



Nylon cuff with velcro fastening, EPDM syntetic rubber bladder, latex free

MINI CUFFS grey/green - nylon				
1 tube	2 tubes	Model	Size cm	
32810	32820	Premature	16xh 5	
32811	32821	Up to 3 months	23xh 5	
32812	32822	4 months to 3 years	29xh 7	
32813	32823	3-7 years	33xh 9	
32814	32824	7-10 years	40xh 11	
32816	32826	32810-14, 32820-24	Set 5 pieces	



Calibrated nylon cuffs with TPU bladder and PVC tube

CALIBRATED CUFFS - latex free - nylon				
1 tube	2 tubes	Model	Size cm	Colour
-	32839	Pediatric	35x11	Black
32846	32847	Pediatric	35x11	Blue
32842	32843	Adult	49x15	Blue
32844	-	Adult	49x15	Red
32845	32850	Adult	49x15	Black
32848	32849	Adult large	62x17.5	Blue
-	32841	Adult large	62x17.5	Black



CUFFS grey/black - nylon - TPU bladder - velcro fastening				
1 tube	2 tubes	Model	Arm circumference	Size cm
32886	32887	Infant	13 to 19 cm	7.5x26
32888	32889	Child	18.4 to 26 cm	11x34
32830	32832	Adult	25 to 40 cm	52x15
32834	32835	Adult large	35 to 50 cm	61x17.5
32837	32838	Thigh	41 to 66 cm	82x21

ADULT CUFFS grey/green - cotton - TPU bladder - velcro fastening				
1 tube	2 tubes	Model	Size	Arm circumference
32829	-	Adult	53x14.5	

One tube cuff for Ranger, Sino, London, Boston, Roma 1T, Tokyo, Ri-san, Precisa, Minimus.
Two tubes cuff for Minor, Diplomat, Yton line, Roma 2T, Dallas, Big Ben, Empire.



Bladderless nylon cuffs
- reusable above 10,000 times
- washable up to 60°C
- disinfectable with alcohol/ethanol
- ideal to prevent cross-contaminations
- soft surface for a pleasurable feeling on the skin
- tested according to ISO 105 E01

BLADDERLESS ONE PIECE CUFF - latex free				
1 tube	2 tubes	Model	Size	Arm circumference
32910	32913	children	10x34 cm	19 to 27 cm
32911	32914	adult	14.5x54 cm	26 to 41 cm
32912	32915	adult large	16x63 cm	34.3 to 51 cm

SPHYGMOMANOMETERS SPARE PARTS AND ACCESSORIES



code	SPHYGMOMANOMETERS SPARE PARTS	Minimum order
32865	Coiled tubing - black (42-45 spirals) - 48 cm	10 pcs.
32808	Nylon velcro cuff (no bladder) 54 x15 cm	10 pcs.
32874	1 tube Bladder	10 pcs.
32875	2 tubes Bladder	10 pcs.
32876	1 tube + 1 hole Gimatono Bladder	10 pcs.
32880	Vertical glass tube	10 pcs.
32870	Male-Female metal connector	box 10
32871	Screw Type metal connector	box 10
32872	Bayonet Type metal connector	box 10
32873	Plastic connector	box 100



code	SPHYGMOMANOMETERS SPARE PARTS	Minimum order
32854	Yota PVC bulb - black - latex free	10 pcs.
32851	Yota PVC bulb - green	10 pcs.
32855	Yota latex bulb - black	10 pcs.
32860	Superior PVC bulb - green - latex free*	10 pcs.
32859	Superior PVC bulb - black*	10 pcs.
32852	Yota chrome-plated air release valve	10 pcs.
32861	Superior chrome plated air valve	10 pcs.
32853	Yota inflation system	10 pcs.
32862	Superior inflation system - latex free*	10 pcs.
32863	Deluxe inflation system	10 pcs.

*Made in Germany

BABYPHON® RIESTER PEDIATRIC SPHYGMO



- 32710 BABYPHON® PEDIATRIC SPHYGMO with 3 cuffs
 - Palm pediatric sphygmomanometer with 3 cuffs
 - fast inflation of the cuff due to ergonomic spoon-shaped stainless steel handle
 - easy reading metal manometer with aluminium scale Ø 49 mm (1.929 inch)
 - lifelong precision due to almost non-aging precision movement with specially tempered copper-beryllium diaphragm for pressure-loading capacity up to 600 mmHg
 - linear scale up to 300 mmHg, ±3 mmHg
 - bear imprint on the cuffs
- Supplied with 3 pediatric cuffs (child, infant and new-born in a padded nylon zipper case).
 Newborn: size 15.5x5 cm - circumference 5-8 cm
 Infant: size 23x7.5 cm - circumference 8-13 cm
 Baby: size 35.5x10 cm - circumference 13-17 cm



Riester

PRESS^{SAN}® HYGIENIC PROTECTION OF SPHYGMOMANOMETER

- 32858 PRESS^{SAN}® HYGIENIC PROTECTION OF SPHYGMO - box of 10

A practical hygienic accessory for the sphygmomanometer to protect patient's skin whilst measuring the blood pressure. Made of a white non-woven fabric. Ensures patient's comfort and hygiene. Can fit any kind of sphygmomanometer or pressure holter.



32858

RIESTER ORIGINAL CUFFS - LATEX FREE

code	RIESTER code	RIESTER CUFFS 1 TUBE	Colour	Size cm	Circumference cm	Compatibility
49811	129	Child velcro cuff	light blue	34.5x10	13-17	Minimus II®, Precisa, Ri-san, R1 Shock proof, E-Mega®, Baby phon®
49812	107	Adult velcro cuff	black	54.5x14.5	24-34	
49813	122	Adult/large velcro cuff	black	70x15	34-44	
ONE PIECE RIESTER CUFFS 1 TUBE						
washable at 60°C and disinfectable in liquid reusable up to 10,000 times. ISO 105 E01 tested						
49816	154	Child one-piece cuff	dark green	35.5x10	13-17	Same as cuffs 1 tube
49817	150	Adult one-piece cuff	dark green	54.5x14.5	24-32	
RIESTER CUFFS 2 TUBES						
49821	130	Child velcro cuff	light blue	35.5x10	13-17	Big Ben
49822	108	Adult velcro cuff	black	54.5x14.5	24-32	

*Metal valve not included with spare cuff, can use valve from old cuff

Riester



HEINE ORIGINAL CUFFS - LATEX FREE

code	HEINE code	HEINE CUFFS 1 TUBE	Colour	Size cm	Circumference cm	Compatibility
49801	M-000-09-702	Child - 2	grey	10x34	13-20	All Heine 1 tube
49802	M-000-09-704	Adult small - 3	grey	14x53	20-29	
49803	M-000-09-619	Adult - 4	grey	14x58	29-41	
49804	M-000-09-706	Adult large - 5	grey	17x70	35-47	

Water resistant washable material



ERKA ORIGINAL GREEN SUPERB CUFFS - LATEX, PVC, DEHP FREE

Made in durable patented German PU material, perfect for cleaning and disinfection

code	ERKA code	ERKA CUFFS 1 TUBE - grey	Size cm	Circumference cm	Compatibility
32895	025-28493	Infant	21.5x6.6	10-15	Switch and Kobold
32896	025-27493	Baby	30.3x9.1	14-21.5	
32891	025-26493	Child	40x11.6	20.5-28	
32892	025-20493	Adult	47x14.3	27-35	
32893	025-24493	Adult large	56x17.5	34-43	
32894	025-29493	Thigh	75x21.5	42-54	
ERKA CUFFS 2 TUBES - green					
32898	025-26481	Child	40x11.6	20.5-28	Vario
32899	025-20481	Adult	47x14.3	27-35	
32900	025-24481	Adult large	56x17.5	34-43	
ERKA TWIN TUBE CUFFS - green					
32877	025-26482	Child	40x11.6	20.5-28	Perfect Aneroid and Profi
32878	025-20482	Adult	47x14.3	27-35	
32879	025-24482	Adult large	56x17.5	34-43	



Twin tube

RIESTER ANEROID SPHYGMO - MADE IN GERMANY



Sturdy and light aluminium casing, corrosion protected

High-polished manometer surface, easy to disinfect

Riester
CE 0124



Non-resistant opening of air release valve ensures precise and comfortable operation

Large dial 63 mm

Shock protecting polycarbonate case

SHOCK PROOF

Spoon-shaped handle made of stainless-steel

Fast, ergonomic inflation due to optimized bulb design with integrated spoon

32716

CE 0124
Riester

CE 0124
Riester

- **32686 SANAPHON SPHYGMO with integrated stethoscope**
A classic palm-style sphygmomanometer for precise self-measurement including stethoscope. Sanaphon® guarantees exact measurement values even for patients with heart rhythm disturbances.
- maximum error tolerance ± 3 mmHg
- supplied in zipper bag

- **32687 E-MEGA SPHYGMO**
With disinfectable latex free one-piece cuff.
- fast inflation of the cuff due to new ergonomic spoon design
- lifelong precision due to almost non-aging precision movement, with specially tempered copper-beryllium diaphragm for pressure-loading capacity up to 600 mmHg
- comfort - air release valve, wearfree, with fine adjustment

- **32716 R1 SHOCK PROOF SPHYGMO**
Exact precision that lasts a lifetime. Made in Germany, 5 years warranty on calibration.
- shock-proof up to a falling height of 120 cm
- scale: \varnothing 52 mm black with red fluorescent pointer
- valve base and air duct with metal precision valve
- two-component ABS casing
- metal threaded tube connection at the top of the casing for fast cuff exchange and ergonomic operation.
- maximum error tolerance of ± 3 mmHg
- weight: 173 g
- supplied in zipper bag
- latex free

Riester

CE 0124



Easily readable scale \varnothing 64, from 0 to 300 mmHg, ± 3 mmHg

32715

Precision air release valve with fine adjustment and wear-free

Suitable for right or left handed users

- **32715 RI-SAN® SPHYGMO**
High quality palm-style sphygmomanometer with ergonomic design. Air release valve conveniently regulated by finger-tip control.
- calibrated nylon cuff with velcro
- latex-free bulb for pumping up the cuff
- tube connection at the top of pressure gauge for unhindered blood pressure measurement
- microfilter protects air release valve and measuring system
- specially tempered copper-beryllium diaphragm almost non-aging
- the precision movement guarantees reliable measurement
- diaphragm can be pressurized up to 600 mmHg without decalibrating the sphygmo.

Riester

CE 0124



Easily readable scale \varnothing 64, from 0 to 300 mmHg, ± 3 mmHg

32717

Precision air release valve with fine adjustment and wear-free

- **32717 PRECISA® N SPHYGMO**
A typical Riester quality product. In metal with aluminium housing and single tube - plug-in connection.
- calibrated nylon cuff with velcro.
- latex-free bulb, and metal valve base
- ergonomic grip of stainless steel
- microfilter protects air release valve and measuring system
- specially tempered copper-beryllium diaphragm, with precision movement and almost non-aging
- diaphragm pressure-loading capacity up to 600 mmHg
- scale, from 0 to 300 mmHg, ± 3 mmHg
- Supplied with synthetic leather bag.

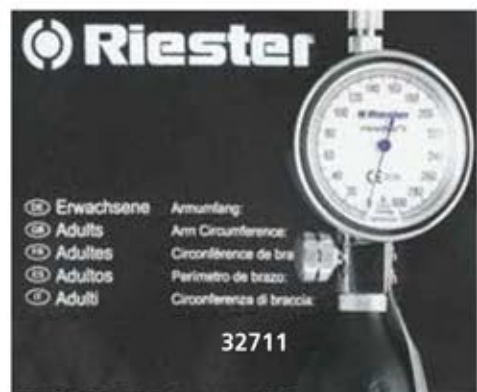

Riester
CE 0124



32711 MINIMUS® II SPHYGMO

- MINIMUS® is a reliable, durable and elegant palm model aneroid manometer with integral latex-free bulb and air release valve for one hand use, provided with a stainless steel handle, Luer Lock connection, calibrated black nylon velcro closure cuff and 1 tube bladder. Supplied in a nice synthetic leather bag.

KOBOLD SPHYGMOMANOMETER BY ERKA

- 32691 BLACK KOBOLD with gray cuff - 223.20493
- 32695 GREY KOBOLD SET with 3 ped. "Superb" cuffs - 227.71.393
- 32696 GREY KOBOLD SET with 6 "Superb" cuffs - 227.71.195

Elegant and compact, single tube sphygmomanometer for frequent use in clinic and consulting room. Precision manometer, anodised aluminium Ø 48 mm. Sensitive adjustable air reduction valve, high quality chrome finish. Scale: 300 mmHg, 2 mm scale division. New technology with air intake via the manometer capsule in the specially tempered copper-beryllium membrane. Codes 32693, 32695, 32696 are latex free. Made in Germany.

ERKA "SUPERB" GREEN CUFFS

All ERKA Green cuff products are PVC, demp and latex-free, every one is individually tested prior to delivery and guaranteed for 50,000 inflation cycles. They are equipped with clearly marked size and positioning features for the most accurate possible measurements. The soft, easy to disinfect, biocompatible materials ensure maximum patient comfort. Conform to ANSI/AAMI SP10 standard

- 32891 PEDIATRIC "SUPERB" CUFF 1 TUBE 20.5 - 28 cm - grey
- 32892 ADULT "SUPERB" CUFF 1 TUBE 27-35 cm - grey - spare



32691

ERKA.



32696

CE 0124

Includes 6 cuffs for below indicated circumferences of upper arm

Thigh
42-54 cm

Adult large
34-43 cm

Adult
27-35 cm

Child
20.5-28 cm

Baby
13-20 cm

Infant
10-15 cm



CE 0124

32695

Child
20.5-28 cm

Baby
14-21.5 cm

Infant
10-15 cm

PERFECT ANEROID

ERKA SWITCH

ERKA SWITCH SIMPLEX



32688

Erka Superb Green cuff. Latex, PVC and DEHP free

ERKA.

- 32688 ERKA PERFECT - 201.204.82 dial Ø 48 mm - 2 tubes green
- Sphygmomanometer with screw valve for sensitive adjustments, velcro cuff and case.
- manometer housing brass chromed plated
 - membrane-protection 2-tube technology
 - measuring range 0-300 mmHg ±1%
- Made in Germany. 3 year warranty.
- 32877 PEDIATRIC "SUPERB" CUFF TWIN TUBE 20.5 - 28 cm - grey
 - 32878 ADULT "SUPERB" CUFF TWIN TUBE 27-35 cm - grey - spare



32698

ERKA.

- 32698 ERKA SWITCH 2.0 CONFORT - dial Ø 56 mm - 1 tube grey - 293.204.93
- It offers outstanding ergonomics and simple adaptation for left and right-handle users. It is manufactured from shock-resistant polycarbonate and has passed the shock test according to AAMI SP9. The sight glass is chemically stable and unbreakable. The brass valve screw works smoothly and is adjustable to exact settings. MR compatibility. Measuring range 0-300 mmHg ±1%. Supplied with pouch. Made in Germany. 4 year warranty hand held, 2 year manometer.
- 32891 PEDIATRIC "SUPERB" CUFF 1 TUBE 20.5 - 28 cm - grey
 - 32892 ADULT "SUPERB" CUFF 1 TUBE 27-35 cm - grey - spare



32697

ERKA.

- 32697 ERKA SWITCH SIMPLEX - dial Ø 56 mm - twin tubes grey - 294.408.94
- It is manufactured from shock-resistant polycarbonate and has passed the shock test according to AAMI SP9. The sight glass is chemically stable and unbreakable. The brass valve screw works smoothly and is adjustable to exact settings. Measuring range 0-300 mmHg ±1%. Black velcro cuff. Supplied with pouch. Magnetic Resonance (MR) compatibility. Made in Germany. 2 year warranty.

BOSTON SPHYGMO ■ G5® AND G7® HEINE SPHYGMO

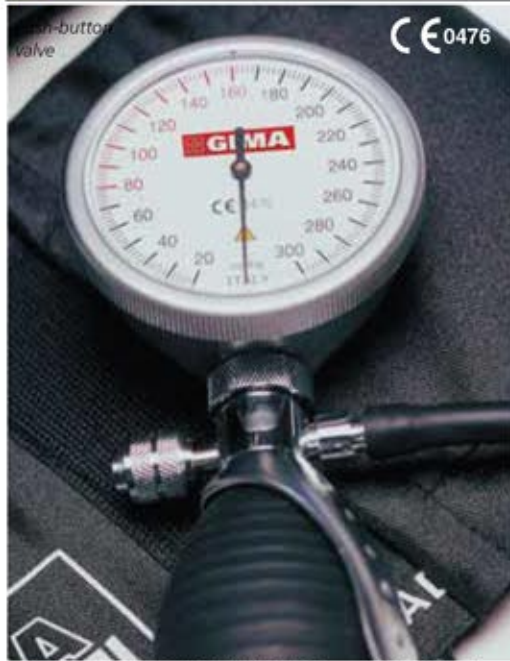

• 32731 BOSTON SPHYGMO - adult - black cuff ■
 Strong durable and elegant palm model aneroid metal zinc-alloy manometer with integral PVC bulb and air release valve for one hand use, provided with a special left and right hand adjustable handle, nylon velcro closure calibrated cuff and 1 tube TPU bladder. Easy to read: large dial Ø 60 mm. Unique push button air release valve offers precise mini-deflation. Special PVC patented ribber bulb. Latex free. Supplied with a nice nylon carrying bag. Multilanguage box and manual: GB, FR, IT, ES, PT, DE, GR, Arab.



10 YEARS WARRANTY

5 YEARS WARRANTY

The inflator spoon can be set for left and right-handed users.

- 32737 GAMMA "G5®" HEINE SPHYGMO - plastic manometer - M-000.09.230
 - 32741 GAMMA "G5®" HEINE SPHYGMO - plastic manometer Same as 32737, but supplied without carrying bag.
 - 32739 GAMMA "G7®" HEINE SPHYGMO - aluminium manometer - M-000.09.232
- With the new latex free G5® and G7® Heine, GIMA offers an aneroid sphygmomanometer of the highest quality of design and function with unequalled value for money. A modern, functional design combined with exceptional precision of measurement and durability make Heine G5® and G7® ideal for long-term use in clinic and practice environments.
- latex-free
 - exceptionally-strong housing construction with triple-mounted, shockproof movement.
 - impact-resistant housing crafted in special, shock-absorbing materials incorporate the latest advances in injection-moulding technology.
 - a microfilter protects the valve and movement.
 - oversized inflator speeds up cuff inflation.
- Made in Germany. 5 years warranty (G5), 10 years warranty (G7).



G5® and G7® (excluding 32741) are supplied with high quality HEINE carrying bag.

WELCH ALLYN® DURA SHOCK™ DS55 SPHYGMOMANOMETER



10 years calibration warranty

Laser engraved dial

Shock resistant body

WelchAllyn®

- 32700 DURA SHOCK DS55 SILVER LINE - DS-5501-189
- Welch Allyn's DS55 sphygmomanometer incorporating shock-resistant DuraShock technology offers practical benefits compared to traditional aneroid sphygmomanometers. This is especially beneficial in busy medical environments where equipment needs to be as robust as possible. With DuraShock Technology, Welch Allyn B.P. gauges:
- remain in calibration longer than traditional aneroid B.P. gauges, providing you with more accurate readings.
 - do not need to be replaced as often as traditional aneroid B.P. gauges, giving you a lower lifetime cost.
 - have the only gauge capable of passing AAMI's shock-resistant specification of surviving a 76 cm drop onto a hard surface and remaining in calibration.



How DuraShock technology works

In traditional aneroid sphygmomanometer design, several delicate gears and springs convert and amplify vertical movement of the pinion to rotational movement to turn the pointer. The DuraShock gear-free design uses a single helix spring to directly convert the vertical movement of the pinion to rotation of the pointer without the use of a multi-step gear arrangement. By creating a gear-free design, the Welch Allyn DuraShock has fewer moving parts providing a gauge which is shock resistant and lighter than traditional gauges. Until now, a dropped sphygmomanometer required recalibration or replacement. The DuraShock can fall 76 cm onto a hard surface and still remain accurate. It is the only gauge capable of meeting the AAMI Shock Resistant specification.

LCD DISPLAY, MERCURY-FREE SPHYGMOMANOMETERS

MERCURY FREE SPHYGMOMANOMETERS

A new technology of LCD display mercury-free sphygmomanometers alternative to the mercury column.

Precise results and support to global environment saving pollution. Manual inflation and air release.

Two measuring methods: button AUSC (Auscultation), for use with a stethoscope, button OSCI (Oscillometric), to get the result automatically, without need of a stethoscope, just inflate the cuff not less than 180 mmHg.

Suitable for pediatric use with auscultation method only (need 32825).

Supplied with adult cuff



32800



GREEN AND ENVIRONMENTAL PROTECTION



32801

AND PROFESSIONAL MERCURY FREE SPHYGMOMANOMETERS

Professional highly advanced digital blood pressure monitor alternative to the mercury column

- auscultatory blood pressure measurement
- digital readout for pulse rate

- cuff holder and grip for carrying
- durable and chemical resistant body
- full ABS housing lightweight body
- adjustable display column for easier analysis of results
- anti-glare display minimizes reflected light



Supplied with adult cuff 22-32 cm

32775

32776

- 32800 GREEN MERCURY FREE SPHYGMO - desk
- 32801 GREEN MERCURY FREE SPHYGMO - on trolley with basket
- 32825 PEDIATRIC CUFF 16-22 cm - optional
- 32827 ADULT CUFF 22-32 cm - spare
- 32828 LARGE ADULT CUFF 32-45 cm - optional

TECHNICAL SPECIFICATIONS (32800, 32801)

Size: 360x96x66 mm (32800) Power supply: battery
Measuring range: 20-280 mmHg Accuracy: pressure: ±3 mmHg

- 32758 UM-101 MERCURY FREE SPHYGMOMANOMETER - desk
- 32775 UM-102A MERCURY FREE SPHYGMOMANOMETER - desk
- 32776 UM-102B MERCURY FREE SPHYGMOMANOMETER - trolley

TECHNICAL SPECIFICATIONS

Size: 360x96x66 mm (32775)
Measuring range - pressure: 0-300 mmHg ±3 mmHg
- pulse: 40-180 beats/minute ±5% (32775-6)
30-200 beats/minute ±5% (32758)
Power supply: 2x1.5V AA alkaline batteries

MERCURIAL SPHYGMOMANOMETERS: DESK, WALL, TROLLEY

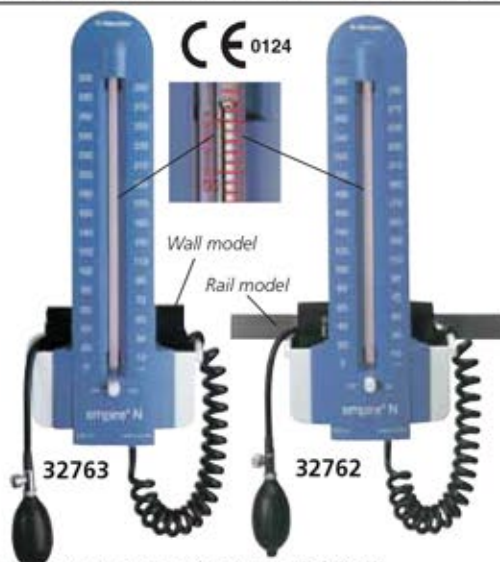

32763

32762

- 32762 EMPIRE - anaesthetic model (rail)
Rail and clamp not included.
- 32766 RAIL clamp (for code 32762)
- 32763 EMPIRE - wall

Attractive mercurial sphygmomanometers. Housing made of resistant engineering plastic, including a basket. Precision glass tube with inner diameter of 4.2 mm ±0.2 mm. Face plate with easy-to-read graduated scale. Maximum reading 300 mmHg ±3 mmHg. Mercury lock. Basket for convenient accessory storage. Coiled tubing extensible to 3 m. With latex free bulb and chromed-plated air release valve.

Made in Germany

- 32883 GLASS TUBE - spare for EMPIRE



32759

32760
YTON

32769

- 32759 YTON MERCURIAL SPHYGMO - pediatric

Desk mercurial sphygmomanometer in aluminium painted case with self locking, with adult nylon cuff with velcro and metal D-ring. Range 0-300 mmHg. PVC latex free.

- 32760 YTON MERCURIAL SPHYGMO - wall
 - 32769 YTON MERCURIAL SPHYGMO - trolley - made in China
- Mercury sphygmomanometers with velcro cuff (2 tubes) and storage compartment. 0-300 mmHg. PVC latex free.
- 32764 KENZ MERCURIAL SPHYGMO - trolley
Same as 32769, made in Japan.

ERKA VARIO DESK WALL AND MOBILE - MADE IN GERMANY

- 32671 VARIO - desk - adult cuff - 285.20.481
 - 32672 VARIO - wall - adult cuff - 288.20.481+295.00.003
 - 32673 VARIO - trolley Ø 50 cm - adult cuff+288.20.481+995.00.003
- Superior quality product, made in Germany, for use in consulting rooms or hospital. The Vario model consists of a high precision manometer in a high quality ABS housing with an integrated fastening spigot for individual variable swivelling, a big cuff basket in white powder coated sheet steel, a bulb holder and spiral tubing with bulb and air release valve. This high quality chromium-plated valve makes sensitive adjustments easy. The 150 mm scale is equipped with a mirrored exterior ring and non-reflective manometer glass.
- 32898 PEDIATRIC "SUPERB" CUFF 2 TUBES - 20.5-28 cm (arm circumference)
 - 32899 ADULT "SUPERB" CUFF 2 TUBES - 27-35 cm (arm circumference) - spare
 - 32900 LARGE "SUPERB" CUFF 2 TUBES - 34-43 cm (arm circumference)



TECHNICAL SPECIFICATIONS		32671
Height with basket:	260 mm (32672-3)	
Width with basket:	180 mm (32672-3)	
Depth with basket:	120 mm (32672-3)	
Graduation:	0-300 mmHg ±3 mmHg	
Weight with basket:	1,350 g	
Height of trolley:	830-1,360 mm (adjustable)	
Tubing system Ø:	18-25 mm	
Swivel range:	up to 60 deg°	

RIESTER BIG BEN® - MADE IN GERMANY

- 32742 RIESTER BIG BEN® - rail (clamp code 32766 and rail not included)
- 32743 RIESTER BIG BEN® - wall Rotation 130°, 65° right, 65° left
- 32746 RIESTER BIG BEN® - trolley Ø 54 cm

Aneroid sphygmomanometer, made of resistant plastic, with large dial (147 mm) and white pointer on black dial plate for easy-to-read measurements from 0 mmHg to 300 mmHg. Basket on back for cuff storage after use. Velcro-closure black cuff 2 tubes, and long coil tubing. Latex free. Quality product: made in Germany.

- 32766 RAIL CLAMP Universal clamp (for code 32742) for any rail.



OMRON PROFESSIONAL B.P. MONITOR

- 32936 OMRON DIGITAL AUTOMATIC B.P. MONITOR HEM-907

Professional B.P. monitor designed for clinical use in professional settings.

- gold standard accuracy
- validated according to international protocols:
- 1- Association for the Advancement of Medical Instrumentation (AAMI)
- 2- European Society of Hypertension - International Protocol (ESH - IP)
- intellisense technology
- irregular pulse indicator
- 3 modes of operation: single mode, average mode, auscultation (manual mode).



Supplied with battery pack, adult cuff (22-32 cm), AC adapter. Made in Japan.

- 32937 ADULT LARGE CUFF 32-42 cm
- 32939 TROLLEY FOR OMRON HEM-907

TECHNICAL SPECIFICATIONS		32936 + 32939
Method:	Oscillometric	
Measurement range:	pressure: 0-299 mmHg ± 3 mmHg or 2% pulse rate: 30-199 beats/min ± 5% of reading	
Inflation:	automatic inflation with pumping	
Deflation:	automatic deflation by electromagnetic control valve	
Air release:	automatic rapid air release by electromagnetic control valve	
Pressure detection:	electrostatic capacity semi-conductor pressure sensor	
Power supply:	AC adapter (230 VAC, 50 Hz, 20 VA) Battery pack (4.8 VDC, 6Wh)	
Electric shock protection method:	Class II B type	
Dimension:	139x203x131 mm (5.1/2"x8"x5.1/6")	
Weight:	approx. 910 g	
Complies with:	EN 1060, EN60601-1-1 - 2007	



DALLAS SPHYGMO: WALL AND TROLLEY



- **32749 DALLAS SPHYGMOMANOMETER - wall model**
Provided with rear plastic basket for cuff storage.
 - **32747 DALLAS SPHYGMOMANOMETER - trolley model**
Provided with stainless steel trolley adjustable in height, with 5 castors.
- All DALLAS sphygmometers are provided with extra large dial plate (Ø 150 mm) for easy reading, black nylon calibrated cuff and latex quality inflation system and bladder. Scale 0-300 mmHg.



DENVER SPHYGMO

- **32744 DENVER SPHYGMOMANOMETER - trolley - adult cuff**
Trolley sphygmomanometer, light but with high stability and 360° swivelling castors. Adjustable height (90 to 135 cm) with metal basket. Square-shaped-dial 145x145 mm. Nylon cuff, 2-tube adult TPU bladder, PVC bulb, dual use air-release valve with spring, spiral PVC tube (1.8 m).
 - **CALIBRATED NYLON CUFFS**
 - **32839 CHILD CUFF - black**
 - **32850 ADULT CUFF - black - spare**
 - **32841 ADULT LARGE CUFF - black**
- All cuffs with 2 tubes TPU bladder.



DAYTON DESK/WALL SPHYGMO

- **32745 DAYTON SPHYGMO - desk/wall model**
Provided with big dial (Ø 113 mm) for easy reading. Basket with handle easy to move and carry. Nylon cuff with D ring. Wall fixing. Size: 130x130x135 mm - Weight: 180g Measuring range: 0-300 mmHg ± 3 mmHg.

Large basket with handle for cuff

CE 0123



PVC bladder and bulb

LATEX FREE

JOLLY DIGITAL B.P. MONITOR



- **32777 JOLLY DIGITAL BLOOD PRESSURE MONITOR**
Professional Blood Pressure monitor for medical use.
 - large easy-to-read illuminated LCD display 86x74 mm
 - WHO classification
 - arrhythmia detection (IHB)
 - 4-person memory zone - 30 memory space each
 - average of all saved measured values and morning and evening blood pressure of the last 7 days
 - time and date
 - automatic switch-off
- Multilanguage manual and box: GB, FR, IT, ES, PT, DE, PL, GR.
- **32922 CUFF - adult - 22-30 cm (8-11") - black - spare**
 - **32923 CUFF - adult large - 30-42 cm (11-16") - grey**
 - **32920 CUFF - adult extra large - 42-48 cm (16-18.2") - grey**

TECHNICAL SPECIFICATIONS

Measurement system:	Oscillometric method
Measurement range:	Pressure: 0-300 mmHg ± 3 mmHg Pulse: 40-180 pulse/min. ± 5%
Power source:	4x1.5 AAA batteries included
Outside dimension:	150x95xh 65 mm
Weight:	approx 235 g (without batteries)

DOMINO DIGITAL B.P. MONITOR



- **32803 DOMINO DIGITAL BLOOD PRESSURE MONITOR**
- **32804 DOMINO DIGITAL B.P. MONITOR on trolley with basket**
Professional Blood Pressure monitor for hospital and medical use.
- extra large LCD display with innovative design
- date/time/ambient temperature (°C/°F) display
- IHB Irregular heartbeat detector
- 120 memories (60 sets for 2 users)
- alarm clock reminding function
- WHO blood pressure classification indicator
- **32802 AC ADAPTOR**
- **32809 ADULT CUFF - spare**
- **32865 COILED TUBING EXTENSION 3 m (42/45 spirals)**

TECHNICAL SPECIFICATIONS

Measuring range:	Pressure - 40 - 260 mmHg	Pulse: 40 - 160 beats/min.
Accuracy:	Pressure ± 3 mmHg	Pulse: ± 5%
Power supply:	4x "AA" batteries or AC adaptor (option)	
External dimension:	158(L)x120(W)x127(H) mm	Weight: 490 g

X-LIFE AUTOMATIC DIGITAL B.P. MONITORS - ESH VALIDATED

Size: 140x104x50 mm
Weight: 247 g
LCD size 60x51 mm

Cuff size for arm
circumferences
23-33 cm



32924

Supplied with
carrying bag



Size: 74.5x74x30 mm
Weight: 95 g
LCD size 34.5x42 mm

Cuff size for arm
circumferences
13.5-19.5 cm



32926

Liquid crystal
display



- 32924 X-LIFE B.P. MONITOR - arm
 - 32926 X-LIFE B.P. MONITOR - wrist
- Accurate and precise automatic digital blood pressure meters for smooth and fast measurements with innovative functions:
- IHB: irregular heartbeat detector
 - WHO risk category indicator (classifies your measurements in 6 stages of risk, from optimal to severe hypertension)
 - proven clinically to meet European Society of Hypertension ESH protocol
 - easy to read, wide angle display
 - 120 memories for 3 users: 3 zones of 40 memories each
 - start/stop unique button, with blue backlight

- multilanguage manual and box: GB, FR, IT, ES
- memory average: automatically average last 3 memories
- 32925 SPARE CUFF for 32924 - adult
- 32927 AC ADAPTOR for 32924

TECHNICAL SPECIFICATIONS

Measuring method:	oscillometric
Measuring range:	pressure: 0-300 mmHg pulse: 40-199 bpm
Accuracy:	pressure: ± 3 mmHg pulse: $\pm 5\%$
Power supply:	arm type: 4xAA alkaline batteries wrist type: 2xAAA alkaline batteries
Battery life:	arm type: 300 measures wrist type: 250 measures

SMART AUTOMATIC DIGITAL B.P. MONITOR - ESH VALIDATION



Display 62x43 mm LCD



European Society
Hypertension

32921



- 32921 SMART AUTOMATIC B.P. MONITOR with adult cuff
- Compact, fully logic, multiuser, B.P.M. with innovative features:
- smart inflation technology for automatic pumping to proper pressure
 - WHO blood pressure indicator
 - IHB Irregular Heartbeat Detection
 - average value of latest 3 readings
 - 2x60 memories, date and time
 - displays systolic, diastolic and pulse rate separately
 - multilanguage manual and box: GB, FR, IT, DE, ES, PT, PL, GR, Arabic
 - 32922 CUFF - adult - 22-30 cm (8-11") - black - spare
 - 32923 CUFF - adult large - 30-42 cm (11-16") - gray
 - 32920 CUFF - adult extra large - 42-48 cm (16-18.2") - gray

TECHNICAL SPECIFICATIONS

Measuring method:	oscillometric, automatic inflation and measurement
Measuring range:	cuff pressure: 0-300 mmHg ± 3 mmHg pulse rate: 40-180 beats/min $\pm 5\%$ of reading systolic: 60-260 mmHg diastolic: 40-199 mmHg
Power supply:	4x AA batteries 1.5 V
Dimensions:	138x98x48 mm
Weight:	211 g (excluding batteries)
Arm cuff:	for arm circumferences 22-30 cm, 30-42 cm or 42-48 cm

SMART AUTOMATIC DIGITAL WRIST B.P. MONITOR



European Society
Hypertension

Display 31.9x39.6 mm LCD

32918



- 32918 SMART AUTOMATIC WRIST B.P. MONITOR
- Compact, fully logic, B.P.M. with innovative features:
- smart inflation technology for automatic pumping to proper pressure
 - WHO blood pressure indicator
 - IHB Irregular Heartbeat Detection
 - average value of latest 3 readings
 - 2x60 memories, date and time
 - displays systolic, diastolic and pulse rate separately
 - multilanguage manual and box: GB, FR, IT, DE, ES, PT, PL, GR, Arabic

TECHNICAL SPECIFICATIONS

Measuring method:	oscillometric, automatic air inflation and measurement
Cuff pressure:	0-295 mmHg ± 3 mmHg
Pulse rate range:	40-180 beats/min $\pm 5\%$ of reading
Range of measurement:	30-280 mmHg
Power supply:	2x AAA batteries 1.5 V
Dimensions:	84x64x28 mm
Weight:	110 g (excluding batteries)
Wrist cuff:	applicable for wrist circumferences 14-19.5 cm

GIMA DIGITAL BLOOD PRESSURE MONITORS



- 32787 GIMA AUTOMATIC B.P. MONITOR
 - 32788 SPARE CUFF - adult
- Innovative design digital fully automatic blood pressure meter:
- one-touch measurement
 - 30 sec. measurement time for normal blood pressure
 - 4 persons use / 30 memories each - power saving system

- 32786 GIMA AUTOMATIC WRIST B.P. MONITOR
- Reliable digital blood pressure monitor with following features:
- one touch automatic inflation and deflation
 - large LCD display with date and time
 - 2 person use / 60 memories each - power saving system

TECHNICAL SPECIFICATIONS

Measuring method: oscillometric
 Display: Systol, Diastol and Pulse
 Measuring range: 20-280 mmHg (cuff pressure)
 40-195 beats/min (pulse rate)
 Accuracy: Pressure: ± 3 mmHg
 Pulse: ±5% of reading
 Power supply: 4x "AA" batteries
 Dimensions: 140x120x70 mm
 Weight: 300 g (ex. batteries) Arm cuff: 22-34 cm

TECHNICAL SPECIFICATIONS

Measuring method: oscillometric
 Measuring range: Pressure 20-280 mmHg
 Pulse 40-195
 Accuracy: Pressure: ± 3 mmHg
 Pulse: ±5% of reading
 Power supply: 2x "AAA" batteries
 Dimensions: 80x60x75 mm
 Weight: approx 130 g (including cuff, ex batteries)
 Wrist circumference: 13.5 - 19.5 cm

ANDON VALUE DIGITAL B.P. MONITOR

- 32901 ANDON B.P. MONITOR
 - 32922 CUFF - adult - 22-30 cm
 - 32923 CUFF - adult large - 30-42 cm
 - 32920 CUFF - adult extra large - 42-48 cm
- TECHNICAL SPECIFICATIONS**
- Measurement system: Oscillometric method
 Measurement range: Pressure: 0-300 mmHg ±3 mmHg
 Pulse: 40-180 pulse/min ±5%
 Power Source: 4x1.5 V AAA batteries - not included
 Dimensions - weight: 107x80x52 mm - 170 g (ex. batteries)
 LCD size: 66x58.5 mm
-

- large easy to read LCD display, WHO blood pressure indicator
 - 4 groups x 30 times with time and date stamp
 - average of all saved measured values and morning and evening blood pressure for the last 7 days
 - arrhythmia detection (HB)
 - automatic switch-off.
- ESH** Cuff circumference: 22-30 cm
-

FULLY AUTOMATIC B.P.M.



- 32947 WIDE BLOOD PRESSURE MONITOR
- easy to use and clear LCD display
- 60 memories
- automatic switch-off
- for upper arm circumference 22-30 cm
- 32922 ADULT CUFF 22-30 cm - black - spare
- 32923 ADULT L CUFF 30-42 cm - grey
- 32920 ADULT XL CUFF 42-48 cm - grey

TECHNICAL SPECIFICATIONS

Measurement system: Oscillometric method
 Measurement range: Pressure: 0-300 mmHg ±3 mmHg
 Pulse: 40-180 pulse/min ±5%
 Power Source: 4xAAA batteries
 Dimensions - weight: 220x66x43 mm - 230 g (without batteries)
 LCD size: 102.2x27.3 mm

TALKING B.P. MONITOR



- 32940 TALKING BLOOD PRESSURE MONITOR* - GB, FR, ES, PT, Arabic
- 32941 TALKING BLOOD PRESSURE MONITOR** - IT, SE, FI, DE, TR
- 32942 TALKING BLOOD PRESSURE MONITOR** - IT, RO, BG, HU, RU
- *Manual: GB, FR, ES, PT **Manual: IT, GB
- 32943 AC ADAPTER 230V - 50 Hz
- 32922 ADULT CUFF 22-30 cm - black - spare
- 32923 ADULT L CUFF 30-42 cm - grey
- 32920 ADULT XL CUFF 42-48 cm - grey

TECHNICAL SPECIFICATIONS

Measurement system: Oscillometric method
 Measurement range: Pressure: 0-300 mmHg Pulse: 40-180 pulse/min
 Accuracy: Pressure: ±3 mmHg Pulse: ±5%
 Power Source: 4xAA batteries, optional AC/DC 6V adapter
 Dimensions - Weight: 153x108x60 mm - 290 g (without batteries)
 LCD size: 60x71 mm

OMRON DIGITAL BLOOD PRESSURE METERS



The IntelliSense™ technology ensures that the right inflation pressure is automatically detected. It detects irregular pulses and decides fully automatically if the measurement result is usable or the measurement needs to be repeated. Only accurate results are displayed.



OMRON connect mobile application for iPhone/Android

OMRON BLOOD PRESSURE MONITOR USER GUIDE

	M7 INTELLI IT	M6 COMFORT IT	M3	M2	RS3
Clinically validated*	X	X	X	X	X
Intellisense technology	X	X	X	X	X
Irregular heartbeats detector	X	X	X	X	X
Cuff position detector	X	X	X	X	X
Cuff	Moulded comfort cuff 22-42 cm	Moulded comfort cuff 22-42 cm	Long lasting cuff 22-42 cm	Cuff 22-32 cm	Wrist cuff 13,5-21,5 cm
Memory measurements	100 for 2 users	100 for 2 users	60 for 2 users	30	60
Movement detector	X	X	X		
Blood pressure light indicator**	X	X	X		
Average 3 last measurements***	X	X	X		
Morning hypertension	X	X			
Intelli Wrap technology****	X	X			
PC connection	X				

*To verify validations, please see www.dablededucational.org

**Signal in case the values exceed the E.H.S. standards for domiciliary auto-measurements (85 systolic pressure and/or 135 diastolic pressure)

***Average of 3 last measurements made in a 10 min period of time

****360° accuracy: accurate measurements from any position around the upper arm



CE 0197

• 32949 OMRON M7 INTELLI IT - HEM-7322T-E

With Intelli wrap cuff technology. Cuff 22-42 cm.

The connect OMRON app for smartphone allows to monitor parameters, create personalized programs, download data on PC and share them with physician. Multilanguage box and manual: GB, FR, IT, ES, DE, NL, RU, TR, Arabic.

• 32929 AC/DC ADAPTOR



Intelli wrap cuff fits normal and large arms and eliminate inaccurated readings associated with incorrect positioning

CE 0197

CE 0197

CE 0197

• 32944 OMRON M2 HEM-7121-E with Easy cuff 22-32 cm.

Multilanguage box and manual: GB, FR, IT, ES, DE, NL, RU, TR, Arabic.

• 32933 ADULT EASY CUFF 22-32 cm - HEM-CR24 - spare

• 32929 AC/DC ADAPTOR

• 32928 OMRON M3 HEM-7131-E With Easy cuff 22-42 cm.

Multilanguage box and manual: GB, FR, IT, ES, DE, NL, RU, TR, Arabic.

• 32938 ADULT EASY CUFF 22-42 cm - HEM-RML31 - spare

• 32929 AC/DC ADAPTOR

• 32948 OMRON M6 COMFORT - HEM-7321-E

With Intelli wrap cuff technology. Cuff 22-42 cm.

Multilanguage box and manual: GB, FR, IT, ES, DE, NL, RU, TR, Arabic.

• 32929 AC/DC ADAPTOR



CE 0197

• 32932 OMRON RS3 HEM-6130-E

Multilanguage manual and box: FR, IT, NL, DE, Arabic

TECHNICAL SPECIFICATIONS

	32944 M2	32928 M3	32948 M6 32949 M7	32932 RS3
Measuring method:	oscillometric			
Measuring range: Pressure:	0 mmHg to 299 mmHg ± 3 mmHg			
Pulse:	40 to 180 min ± 5% of display reading			
Memory (with date and time):	30	60x2 users	100x2 users	60
Inflation:	fuzzy logic controlled by electric pump			automatic
Deflation:	automatic pressure release valve			automatic
Rating:	6VCC 4W			
Power source:	4 "AA" batteries 1.5 V	4 "AA" batteries 1.5 V	4 "AA" batteries 1.5 V	2 "AAA" batteries 1.5 V
Battery life (N° of measurements):	1000	1000	1000	300
Protection against electric shock:	internally powered ME equipment (when using batteries)			
Weight (console+cuff) whitout batteries:	250+130 g	280+170 g	380+163 g	101 g
Size:	103x80 xh 129 mm	107x141xh 79 mm	124x161xh 90 mm	78x60 xh 21 mm
Cuff materials:	nylon and polyester			
Measurable circumference:	22-32 cm	22-42 (arm)	22-42 (arm)	13.5-21.5 (wrist)

MICROLIFE AFIB BLOOD PRESSURE MONITOR - STROKE PREVENTION

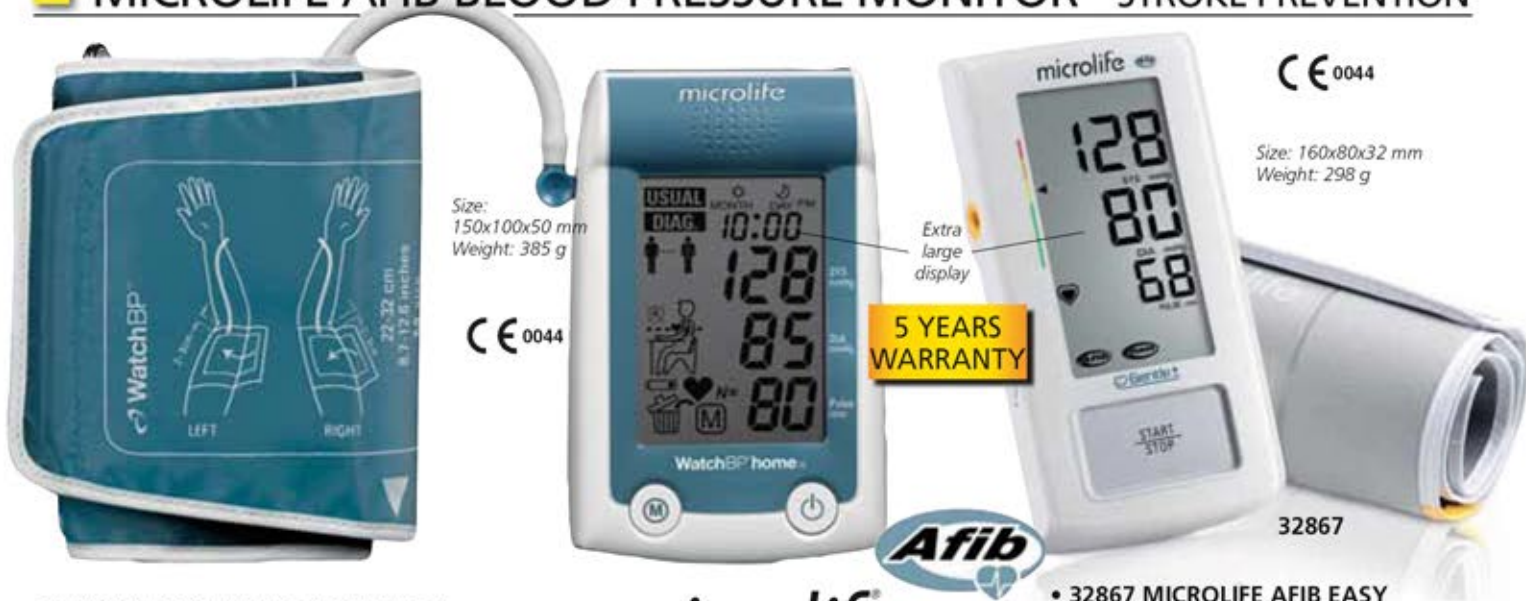

- 32868 MICROLIFE WatchBP Home A (Professional use) + SOFTWARE
- detection of atrial fibrillation (specific heart arrhythmia)
- embedded ESH/AHA measurement guidelines lead to accurate home measurement data physician can trust in
- automated data tabulations displays averages for morning, evening and overall measurement
- clinically tested (BHS protocol)
- MAM technology (automatic analysis of 3 consecutive measurements)
- 250 Data memory in «USUAL» mode
- USB port and mains adapter port
- low battery indication
- 4x1.5 V AA batteries

Supplied with carrying bag, USB cable, soft cuff 22-32 cm software (GB) and manual (GB, IT, FR, ES). Other languages available from web (DE, CZ, DK, GR, FI, HU, NL, NO, PL, RO, RU, SE, SK, SI, YU, UA).

- 32869 ADULT LARGE CUFF 32-42 cm
- 32864 ADAPTER DC 6V, 600 mA

Size: 150x100x50 mm
Weight: 385 g

CE 0044

CE 0044

Size: 160x80x32 mm
Weight: 298 g

5 YEARS WARRANTY

Afib

32867

microlife

DETECTION OF ATRIAL FIBRILLATION

MICROLIFE AFIB technology

An innovative and patented technology for the early detection of Atrial fibrillation (AF) More than 30,000 fatal strokes can be prevented within the European Union by using Microlife AFIB Technology in primary care

The new Microlife AFIB technology allows simultaneous blood pressure measurement and AF screening.

Microlife AFIB technology detects AF with high sensitivity (97-100%) and specificity (89%) as demonstrated in several clinical studies.

Nice guidelines for "Diagnosis and assessment of hypertension" recommended using AFIB screening for routine blood pressure measurement in primary care.

AF screening by using a Microlife AFIB device is highly recommended in patients that have to monitor their blood pressure while at home.

- 32867 MICROLIFE AFIB EASY (Home use)
- detection of atrial fibrillation (specific heart arrhythmia)
- clinically tested (BHS protocol)
- MAM technology (automatic analysis of 3 consecutive measurements)
- 1 Data memory
- traffic light indicator
- low battery indicator
- rechargeable battery-friendly
- mains adapter port
- equipped with world's latest technologies
- Clinically reliable measurements with AFIB & MAM
- 5 years warranty
- Supplied with carrying bag, preformed conical cuff 22-42 cm and manual (GB, FR, IT, DE). Other languages available from web: AR, BG, DK, NL, EE, FI, GR, KZ, LV, LT, NO, PT, RO, RU, ES, SE, UA.
- 32866 ADAPTER DC 6V, 600 mA
- 32884 ADULT CUFF M-L 22-42 cm - spare
- 32885 ADULT CUFF L-XL 32-52 cm

A&D BLUETOOTH BP MONITOR



- 32907 UA-767 BLUETOOTH® BLOOD PRESSURE MONITOR B.P.M. clinically proven in accuracy, with Bluetooth®.

- compatibility with Bluetooth® Android receivers, iOS and Windows
- built-in real time clock
- 200-measurement memory
- irregular Heart Beat Indicator
- extra-large 3-line display for easier reading of results
- one-touch measurement
- comfortable Slim Fit cuff 22-32 cm (8.7"-12.6")
- Supplied with carrying case, batteries and multilanguage manual (GB, FR, ES, IT, DE)

Method
Display type

Measurement range
Accuracy
Pressurization
Depressurization
Deflation
Power supply
Dimensions / Weight
Wireless communication
Compatible with 2 net QUALCOMM LIFE platform

TECHNICAL SPECIFICATIONS

Oscillometric
Digital, LCD16 mm /10 mm digit height, pressure and pulse displayed simultaneously
20 - 280 mmHg (pressure) | 40 - 200 pulse/minute (pulse)
± 3 mmHg (pressure) | ± 5% (pulse)
Automatic pressurization by micro pump
Constant speed exhaust valve
Automatic exhaust by electromagnetic valve
4AA alkaline batteries (R6P) for 450 measurements
64x147x110 mm / Approximately 300 g (0.66 lb)
Bluetooth 2.1 Class 1 SSP, SPP

GEMINI BLUETOOTH 4.0 SPHYGMOMANOMETER

CE 0123 FDA



32908

32908 GEMINI BLUETOOTH SPHYGMOMANOMETER

- Electronic sphygmomanometer with fully automatic measurement of blood pressure.
- wide blue mode backlight LED display 12.8x5 cm.
- 60x2 groups memory
- average function for the last 3 measured values
- IHB function (irregular beat detection)
- WHO graduation (B.P. classification indicator)
- Bluetooth 4.0 connectivity, free APP (iOS and Android) to manage and track BP measurements

32909 DC 6V POWER ADAPTER

TECHNICAL SPECIFICATIONS

MWI Technology (Measuring While Inflating)
 Measuring range: Pressure: 0-300 mmHg \pm 3 mmHg
 Pulse: 40-199 beats/min \pm 5% of reading
 Power supply: 4xAAA batteries (not included)
 DC 6V power adaptor - optional
 Size: 182x100x39 mm Arm cuff: 22-32 cm

ADULT AND PEDIATRIC B.P. MONITOR WITH SpO₂ OPTION

CE 0123 FDA

Supplied with medium cuff (18-26 cm) and multilanguage manual (GB, FR, IT, ES, PT)



32902

PC software for data review, result analysis, trend chart observation and report print

32902 LEO ELECTRONIC SPHYGMOMANOMETER - with software

- Electronic sphygmomanometer with fully automatic measurement of blood pressure and large, high definition colour LCD display. Suitable for adult, pediatric and neonatal use.
- data storage (3 users) for up to 100 groups of data
- automatic one-touch operation
- alarm function with possibility to set alarm limits
- dual scales: kPa and mmHg
- selection of five cuff sizes
- automatic power off
- optional SpO₂

TECHNICAL SPECIFICATIONS SPO₂

SpO₂ range: 0%-100% (resolution 1%)²
 SpO₂ accuracy: 70%-100%: \pm 2%
 PR range: 30-250 bpm, (resolution 1 bpm)
 PR accuracy: \pm 2 bpm or \pm 2% (select larger)

80556 POWER ADAPTOR

code	SPO ₂ PROBES*
32903	SpO ₂ reusable adult probe
33755	SpO ₂ disposable adult probe
33756	SpO ₂ disposable child probe (3-20 kg)
33757	SpO ₂ disposable pediatric probe (10-50 kg)
80558	Extension cable for SpO ₂ probes

*All SpO₂ probes need extension cable

code	CUFFS	Size	Suitable for
80551	Small	6-11 cm	Child small
80552	Small/medium	10-19 cm	Child
80553	Medium	18-26 cm	Adult
80554	Large	22-32 cm	Adult large
80555	X-Large	33-47 cm	Adult extra large

TECHNICAL SPECIFICATIONS SPHYGMO

Measurement method: oscillometric
 Measurement range: 0-38.67 kPa (0-290 mmHg)
 Resolution: 1 mmHg
 Accuracy: static pressure: \pm 0.4 kPa (\pm 3 mmHg)
 Inflation - Deflation: automatic inflation - automatic multistep deflation
 Display: 2.8" colour LCD screen, USB interface
 Power: four "AA" batteries or optional power adapter
 Safety: class II device type BF applied part
 Dimension - Weight: 130x110x80 mm - 300 g

24 HOURS BLOOD PRESSURE MONITOR SYSTEM

CE 0476



32780

32780 DAILY ABPM + software

- A simple, economic and small size unit for 24 hours ambulatory blood pressure monitoring. Main features:
- 4 - memory zones, 99 - readings each (total 396 measurements)
- patient-friendly performance at affordable price
- automatic measurement by two predetermined intervals
- irregular Heartbeat detector, detect a disturbance in the regular rhythm of the heartbeat
- big LCD display showing measuring date and time
- 5 - mode average function, by hour, day, week, month and overall
- transfer to PC via software and USB plug of measured values
- lithium battery, long - time measurement
- Supplied with arm cuff (22-34 cm) carrying bag and software.

32783 ADULT CUFF - spare

32784 LITHIUM BATTERY - spare

TECHNICAL SPECIFICATIONS

Measuring type: Oscillometric system
 Measuring range: Pressure: 20-80 mmHg \pm 3 mmHg
 Pulse: 40-195 beats/min \pm 5%
 Power supply: Lithium Battery, 3.7 V 1050mA
 Weight: Approx. 260g (including cuff, ex. batteries)
 External dimension: 184x84x33 mm Arm cuff: 22-34 cm

24 HOURS ABPM, SpO₂ AND PULSE RATE AMBULATORY MONITOR

- 35110 GIMA ABPM + Pulse rate with software
 - 35112 GIMA ABPM + Pulse rate with software and Bluetooth
 - 35111 GIMA ABPM + Pulse rate + SpO₂ with software
- GIMA ABPM module measures the blood pressure using the oscillometric method with step deflation. Two modes of measurement: manual and automatic. Each mode displays the diastolic, systolic and mean blood pressure. In the MANUAL mode, only one measurement is conducted for each time. In the AUTO mode, the measurement is cycled; you can set the interval time to 5/10/15/20/30/45/60/90 min. (35111) or 15/30/60/120/240 min. (35110, 35112)
- compact and portable, easy to use
 - suitable for adult, pediatric and neonatal patient
 - large colour LCD display of ABPM, SpO₂ and pulse rate
 - adjustable audible and visual alarms
 - real-time ambulatory monitoring 24 hours storage and review of data
 - clinically proven accuracy
 - all data can be transferred to a PC through Windows-based software or to a smartphone through Bluetooth (35112 only).
 - 35113 CHILDREN CUFF - arm circumference 18-26 cm
 - 35114 ADULT CUFF - arm circumference 25-35 cm
 - 35115 ADULT LARGE CUFF - arm circumference 33-47 cm
 - 35116 THIGH CUFF - thigh circumference 46-66 cm
 - 35117 EXTENSION TUBE FOR CUFFS (35113/4/5/6) - 1.5 m - spare
 - 35118 ADULT SpO₂ PROBE - reusable - spare

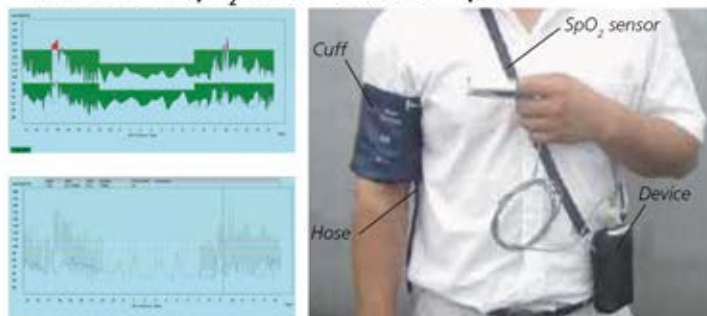

STANDARD ACCESSORIES	
Carrying bag	Software (GB - IT)
3 nylon cuffs (pediatric, adult, adult large) - latex free	Cuff connection tube 1.5 m
SpO ₂ probe (only code 35111)	Batteries
User manual: GB, IT	

TECHNICAL SPECIFICATIONS

Display: colour LCD
 Power: two "AA", 1.5V alkaline batteries
 Dimension: 120x80x32 mm
 Weight: <350 g (including batteries)

SpO₂ (35111 only)
 Measurement range: 0-100%
 Resolution: 1%
 Accuracy: 70-100% ±2%
 Alarm range: 0-100%

NIBP
 Method: oscillometry
 Mode: manual/automatic/continuous
 Measurement range: 0-290 mmHg
 (0 KPa - 38.67 KPa)
 Automatic measurement interval:
 5, 10, 15, 30, 45, 60, 90, 120 min. (35111)
 15, 30, 60, 120, 240 min. (35110, 35112)

Resolution: 1 mmHg
 Overpressure protection: 290 mmHg
 Alarm: systolic 40-270 mmHg
 diastolic 20-235 mmHg
 Map 10-270 mmHg
 (35111 only)

Pulse rate
 Range: 0-250 bpm (35111)
 40-240 bpm (35110, 35112)
 Resolution: 1 bpm
 Accuracy: ±1 bpm
 Alarm range: 30-250 bpm

Operating system
 Windows XP/Seven,
 8, 8.1 (at 32 & 64 bit)

UP TO 52 HOURS AMBULATORY BLOOD PRESSURE MONITOR

- 33351 AM100 GIMA ABPM with adult cuff
- The AM100 is a compact, lightweight instrument that provides a cost-effective solution for monitoring patient's blood pressure outside the clinical environment. AM100 employs the popular oscillometric technique of blood pressure measurement. The simplicity of this technique provides for the quickest patient hook-up. AM100 interfaces with Win Pro PC Software for monitor programming as well as report editing and generation.
- Oscillometric technology:** quick hook-up, making it easy to use, saving your staff time
- Compact and quiet:** silent operation and compact size aid patient compliance.
- Low power consumption:** requires only two "AA" batteries, making this unit much less expensive than others.
- AM100 is supplied complete with software, adult cuff, carrying-bag, English manual and PC connection cable.
- 33348 PEDIATRIC CUFF - arm circumference 18-27 cm
 - 33349 ADULT CUFF - arm circumference 25-35 cm - spare
 - 33353 ADULT LARGE CUFF - arm circumference 33-40 cm

TECHNICAL SPECIFICATIONS

Technique: Oscillometry with step deflation
 Blood pressure range: 25-260 mmHg ±3 mmHg
 Heart rate range: 40-200 bpm
 Display: Liquid crystal
 Recording duration: Up to 52 hours
 Sample quantity: Over 250 sample of systolic, diastolic, MAP and heart rate
 Sampling periods: 3 time periods
 Power source: 3 VDC/Two 1.5 V "AA" Alkaline



Compact size: 12x7x3 cm, and light, 350 g only, including batteries

PG WIN PRO PC INTERFACE

- creates a monitoring plan tailored to an individual patient with up to 3 specific time periods
 - generates concise clinical reports.
- PG Win reports include full disclosure of blood pressure readings, heart rate, mean arterial pressure, blood pressure load and trend of BP values vs. time. Compatible with Windows 95, XP and Windows 7.



MT 10 - HANDHELD IMPEDANCE TYMPANOMETER

- 33665 MT10 - HANDHELD TYMPANOMETER
 - 33666 MT10 - HANDHELD TYMPANOMETER WITH IPSI-REFLEX
- Professional handheld tympanometer for setting fast and reliable testing in an easy and cost effective way.

Objective analysis

Fast and easy to operate and provides objective measures that cannot be obtained by otoscopy alone.

Easy and fast tympanograms

Results can be obtained with little efforts and with no response required from the patient. This is especially beneficial when dealing with difficult-to-test patients or small children.

Clinical application

Suitable for diagnostic use as tympanometer and (33666 only) reflex responses are all recorded with great detail. You can detect otitis media (a major cause of temporary or permanent hearing impairment in children), a perforated eardrum, cholesteatomas and certain neurological disorders. You can also check tympanostomy tubes and follow up on post medical treatments.

Ipsilateral Acoustic Reflex (33666 only)

Four different reflex tests at 500, 1,000, 2,000, 4,000 Hz may be performed per ear using either fixed or automatic intensity selection. Actual reflex characteristics are displayed on the screen.

30 patients in memory

Can hold test results of up to 30 patients, allowing to screen a large group of patients and print out the data at a later time.

PC-integration with optional infrared USB interface and software. Full data-transfer to PC

- 33667 INTERFACE USB ADAPTER AND SOFTWARE BY IRDA PORT



33669



Interaacoustics

Supplied with handle, set of 139 disposable ear-tips (mixed sizes) 4x1.5 V battery and manual in GB, DE, FR, IT, ES, SE, GR, PT, DK, FI, CZ, PL, LT, EE, HU, NL, NO, IS, RO, MK.

- -400 to +200 daPa
- ipsi-reflex (33666 only)
- 30 patient memory
- PC integration



The MT10 is ergonomic to hold but also offers the possibility of using the included handle to make it even more stable and lightweight as it can rest on your arm during the measurement.

Size: 19x8x4 cm excluding probe (length with probe 22.5 cm)
Weight 285 g without battery

- 33668 BET55 SET OF DISPOSABLE EAR-TIPS - box of 139 mixed sizes
- 33669 SANIBEL MPTII PORTABLE THERMAL PRINTER
- 33670 THERMAL PAPER ROLLS - box of 3

TECHNICAL SPECIFICATIONS

Tympanometry	
Analysis performed:	Peak compliance; peak pressure, gradient; equivalent ear canal volume
Probe tone:	226 Hz
Pressure levels:	+200 daPa to -400 daPa
Ear volume measurement range:	0.2 ml to 5 ml
Sweep speed:	Typically 200-300 daPa/sec; depending on ear & cavity volume
Pressure limits (safety shut off):	+600 to -800 daPa
Reflex measurements (33666 only)	
Measurement mode:	ipsilateral
Reflex tone levels:	500 Hz, 1 kHz, 2 kHz, 4 kHz
Four reflex levels:	100 dB with 5 dB or 10 dB steps; 95 dB, 90 dB or 85 dB with 5 dB steps
Reflex analysis:	Reflex pass/refer at each level tested; Maximum amplitude of each reflex (seen on printed report and PC report); Pressure at which reflex was performed

Data management	
Data storage:	30 records. Any recording can be stored once the tympanogram is viewed
Data held:	Patient Initials, Tympanogram and Reflex graphs and analysis for Left and/or Right Ear, Time and Date of recording, which ears were tested, whether or not the record has been printed and sent to a PC, parameters printed and/or sent to a PC, parameters used for analysis
Other data	
Internal backup:	>30 days without main batteries fitted
Battery Lifetime:	Approx. 400 tests (Alkaline AA batteries)
Supported printer:	Martel MCP8830 or Sanibel MPTII
Interface:	Infra-red, IrDA hardware, 9600 baud
Information printed:	Space for patient and clinician's details, Tympanogram analysis parameters, Tympanogram, Reflex analysis parameters, Reflex graph, S. N. of device, Last and Next Due Calibration dates
Safety standards:	IEC 60601-1, EMC: IEC 60601-1-2
Impedance standard:	IEE 60645-5, Type 2 Tympanometer

PA5 PEDIATRIC PORTABLE AUDIOMETER



- 33601 PA5 AUDIOMETER
- 33602 TDH39 AUDIOMETRIC HEAD PHONE

Paediatric portable audiometer with air conduction, free-field and visual stimulation capabilities. By means of a headphone it can be also used as a regular screening audiometer for adults. PA5 helps doctors in evaluating the auditory behaviour in neonates and infants till 24 months by means of specific tests:

Auropalpebral Reflex (APR) test

APR test is a startle reflex of the eyelid elicited by relatively strong sounds that can be performed on neonates from the day of birth. It is not based on co-operation with the newborn child.

Conditioned Orientation Response (COR) test

Based on the "Orientation Reflex", a natural reflex movement elicited by sound or visual stimulation. If the visual stimulation elicits a reflex which is conditioned by a tone, the child will look towards the visual stimulation as soon as the tone is heard. If the conditioning is effective the child will look in the direction of the sound source even before the visual stimulation is presented.

Visual Reinforcement Audiometry (VRA) test

VRA test is an extension and modification of COR, where the cooperation with the child is less important. Not only the sound

localisation orientation reflex are accepted but also four other reactions: reflex reactions (body and face), search reactions, orientation reactions and spontaneous reactions.

Reflex audiometry and maturation of auditory response tests

Different stimuli are presented in terms of intensity, frequency, duration, direction of sound in order to elicit proper reactions like waking-up, crying, astonishment, direct sound localization.



Supplied with GB manual and quick guide (GB, US, DE, FR, SE, IT, PT, DK, FI, ES, GR, CZ, PL, NL, NO, EE, HU, SL).

33601

TECHNICAL SPECIFICATIONS

Frequencies:	500, 1,000, 2,000, 3,000, 4,000 Hz
Stimuli:	Warble tone, NB and WN
Intensities:	Distance 50 cm: 20/30-80dB HL in 10dB steps, for Warble Tone and WN 10/20-70dB for NB and WN increases intensity by 10 dB
Dimensions - weight:	Distance 16 cm: LxWxH: 25x7x5 cm - 360 g
Power supply:	3AA batteries (included)

BOEL STYLE PEDIATRIC AUDIOLOGY TEST



- 33599 GIMA AUDIOTEST - pediatric audiology test for early detection of childhood deafness

The Boel test is a unique screening tool that tests the hearing abilities and child's response to a sound stimulus, even at an early age (between 6 to 10 months). GIMA audiotest is based on the BOEL test both for the ergonomics (designed to be held in the palm of the hand not visible to the child) and the standard sound of the bells. The two sound stimuli emitted by the audiometer reproduce a dull

low-frequency tone located at about 125-150 Hz and an acute high-frequency tone located at about 5.0-5.1 kHz in exactly the same way as the bells of the Boel test (amplitude 86dBa; 96dBa). Testing the child's response to these highly significant thresholds. Easy to use, with only two buttons for the selection of two frequencies, lightweight and battery-powered.

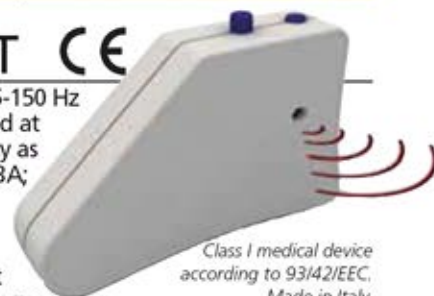

Class I medical device according to 93/42/EEC. Made in Italy.

33599

AUDIOMETRIC BOOTHS - CONFORM TO 93/42/CEE - 2007/47/CE - Class I



- **33650 PRO 25 - 96x96x197 cm**
Portable, lightweight, sound proof booth, easy to install in few minutes. Interior finishing made of acoustic pyramid foam in anthracite grey. External finishing made of highly resistant, fire proof washable panel. Module for cable connection included. Made in Italy.
- **33651 TABLE - 79x50 cm**

ACOUSTIC INSULATION						
Hertz	125	250	500	1000	2000	4000
PRO 25 dB	18.0	16.0	26.7	30.8	28.8	30.9
PRO 28 dB	21.7	25.6	32.6	36.2	34.0	41.1
PRO 30 dB	23.4	24.1	27.8	34.5	31.3	36.4

- **33649 PRO 28F - 96x96x197 cm**
New compact booth with an outstanding level of sound proofing and excellent acoustic thanks to innovative materials. Internal finishing made of fire proof, washable and very resistant fabric. Internal ventilation system. External finishing made of highly resistant, fireproof, washable panel. Module for cable connection included. Made in Italy.
- **33651 TABLE 79x50 cm**

- **33654 PRO 30 - 107x107x242" cm**
- **33653 PRO 30 - 132x132x242" cm**
- **33655 PRO 30 - 211x107x242" cm**
- **33656 PRO 30 - 211x211x242" cm**
- **33657 PRO 30 - size on request**
available any size from 1x1 to 3x3
Range with different sizes, with high noise reduction and ventilation system. External finishing made of highly resistant, fireproof, washable panel and aluminium frame. Module for cable connection included. Made in Italy.
- **33651 TABLE 79x50 cm**
- **33652 RAMPS for wheelchair access**

	33650	33649	33654	33653	33655	33656
External size (cm):	96x96x197	96x96x197	107x107x242"	132x132x242"	211x107x242"	211x211x242"
Internal size (cm):	81x81x180	81x81x173.5	92x92x201	117x117x201	196x92x201	196x196x201
Door size cm:	55x168	55x168	75x200	75x200	75x200	75x200
Door opening:	Left/Right	Left/Right	Right*			
Windows size cm:	56x56	56x56	56x88			
material:	2 - crystal insulating safety glass					
Wall thickness cm:	7.5	7.5	7.5	7.5	7.5	7.5
Weight (kg):	198	233	255	317	356	552
Ventilation:	no	yes	yes	yes	yes	yes
Tested noise reduction dB at 1,000 Hz:	30.8	36.2	34.5			
Internal illumination power V-Hz:	230 - 50/60		86-265 - 50/60			
Norms:	Class I Medical Devices European Directive 93/42 CEE					

STANDARD ACCESSORIES

- module for silent audiometer cable connection
- internal illumination
- ventilation system (PRO 28, PRO 30 only)
- ISPM-15 wooden box for transport
- manual: GB, IT

SINGLE USE TYMPANOMETER EARTIPS - FOR MOST BRANDS



SANIBEL™ ear tips were designed for use with acoustic immittance instruments and otoacoustic emission system. Made of a soft and sticky biocompatible material, these ear tips greatly improve the ease of obtaining and keeping a good seal, allowing the tester to quickly move on to other tasks. Available in different sizes, with different shapes (mushroom and flanged ear tips for infants). The complete range makes it possible to accommodate all ear canal shapes and sizes. All Sanibel™ ear tips are latex free.

code	SANIBEL™ AZE MUSHROOM EAR TIPS	Minimum order
53500	Ear tip 6 mm - violet	bag of 100 pcs
53501	Ear tip 7 mm - yellow	bag of 100 pcs
53502	Ear tip 9 mm - green	bag of 100 pcs
53503	Ear tip 10 mm - light blue	bag of 100 pcs
53504	Ear tip 11 mm - white	bag of 100 pcs
53505	Ear tip 13 mm - yellow	bag of 100 pcs

VERIFIED COMPATIBILITY FOR SANIBEL™ AZE		
Grason-Stadler® Interacoustics®	Tymptar™ AT235™ & AT235h™ with black probe tip AA222™ & AA220™ with black probe tip old MT10™	
Maico® Kamplex®	MI24™, MI26™, MI34™, MI44™ with black probe tip All tympanometers	

code	SANIBEL™ ADI FLANGED INFANT EAR TIPS	Minimum order
53515	Ear tip 3-5 mm - red	bag of 100 pcs
53516	Ear tip 4-7 mm - blue	bag of 100 pcs
53517	Ear tip 5-8 mm - yellow	bag of 100 pcs

code	SANIBEL™ ADI MUSHROOM EAR TIPS	Minimum order
53520	Ear tip 7 mm - blue	bag of 100 pcs
53521	Ear tip 8 mm - yellow	bag of 100 pcs
53522	Ear tip 9 mm - green	bag of 100 pcs
53523	Ear tip 10 mm - red	bag of 100 pcs
53524	Ear tip 11 mm - blue	bag of 100 pcs
53525	Ear tip 12 mm - yellow	bag of 100 pcs
53526	Ear tip 13 mm - green	bag of 100 pcs
53527	Ear tip 14 mm - red	bag of 100 pcs

VERIFIED COMPATIBILITY FOR SANIBEL™ ADI		
Amplivox® Interacoustics®	Otowave™ with clear (Type 1) probe AT235™ & AT235h™ with clear probe tip adapter AA222™ & AA220™ with clear probe tip adapter Eclipse™ and MT10™ with clear probe tip, Titan™	
Maico®	MI24™, MI26™, MI34™, MI44™ with clear probe tip adapter easyTimp™ - Otowave™ - Ero-scan plus™ - easyScreen™	
MEDRx® Grason-Stadler®:	Otowave™ Corti™	

SCREENING AUDIOMETER

2 lines of 24 characters backlit display

53550



Weight: 720 g
Dimension: 252x170x65 mm
Operating power: 100-240 V, 50-60 Hz

• 53550 AMPLIVOX 116 SCREENING AUDIOMETER - air conduction
Combines style and functionality, the ideal manual screening audiometer for primary care, school and workplace. It offers a comprehensive air conduction threshold facility at very affordable price.

- pure tone, continuous, pulsed and warble tones
- threshold retention function
- talk forward function
- 125 to 8,000 Hz test frequency
- -10 to 100 dBHL

Supplied with audiometric headset, patient response switch, audiogram cards (box of 50) main power adaptor, carrying case and manual (GB, IT, ES, on request FR, SE, PT).

- 53555 PELTOR INSULATION HEADBAND
- 53556 AUDIOGRAM CARDS - box of 50



53555

DIAGNOSTIC AUDIOMETER

2 lines of 24 characters backlit display

53551



Weight: 735 g
Dimension: 270x175x68 mm
Operating power: 100-240 V, 50-60 Hz

• 53551 AMPLIVOX 240 DIAGNOSTIC AUDIOMETER - air, bone, masking
Cost-effective diagnostic audiometer, ideal for desktop and mobile use.

- USB connectivity
- threshold retention function
- single, pulsed or warble tone preset
- 11 test frequencies: 125 to 8,000 Hz (AC), 250 to 8,000 Hz (BC)
- -10 to 120 dBHL range (AC), -10 to 70 dBHL (BC), 90 dBHL max (250 to 4,000 Hz) insert masking output
- automatic AC test functionality

Supplied with audiometric headset, bone conductor headset, patient response switch, audiogram cards (box of 50), main power adaptor, carrying case and manual (GB, IT, ES, on request FR, SE, RU, PT).

- 53555 PELTOR INSULATION HEADBAND
- 53556 AUDIOGRAM CARDS - box of 50
- 53557 INSERT FOR MASKING



53557

SCREENING DIAGNOSTIC AND CLINICAL 2 CHANNEL AUDIOMETERS

Dimension: 390x260x105 mm
Weight: 2.4 kg without accessories
Power: 100-240 V, 50/60 Hz

LCD alphanumeric backlight
2 lines of 16 characters

CE 0318



Programme to personalize the audiometer according to the needs of the user

- 33623 SIBEL SOUND 400-A SCREENING AUDIOMETER - air conduction
- 33624 SIBEL SOUND 400-AOM DIAGNOSTIC AUDIOMETER - air + bone + masking
- 33626 SIBEL SOUND 400-SUPRA CLINICAL AUDIOMETER - air + bone + mask + supraliminal tests + W50 software

The SIBEL SOUND 400 is a two-channel digital audiometer based on DSP processing. This audiometer is designed for quick and easy audiometric exploration of hearing thresholds and screening tests, such as suprathreshold pure tone tests (FOWLER-ABLB, TONE DECAY, WEBER, LUSCHER, ...).

- Air conduction (TDH 39): 125 - 8,000 Hz or HF: 8,000 - 20,000 Hz with optional HDA 200
- Levels: AC (-10 to 120 dB HL) / BC (-10 to 70 dB HL) / speech (-10 to 100 dB HL) free field (-10 to 80 dB HL)
- Masking levels (manual or synchronized): NBN AC (-10 to 100 dB HL) NBN BC (-10 to 70 dB HL) white & speech (-10 to 100 dB SPL)
- Tone: continuous, pulse, alternate, amplitude modulation.
- Level increases: 5 (A-AOM), 1 or 5 (SUPRA)
- Frequency precision: $\pm 1\%$ / level precision $\pm 2\%$ db SPL
- Automatic calculation of hearing loss and diagnosis (COUNCIL, IMSS MEXICO, ELI, SAL, KLOCKHOFF, MOH, OTHERS ...)
- Direct USB connection to PC to W50 audiometry software for viewing, storage, transmission, analysis and introduction of audiometric tests (Windows® environment).

- 33628 INTERCOM KIT (headphone + microphone)
- 33621 INSULATION DEVICE for air conduction phone
- 33629 AUDIOMETRY SOFTWARE W50

	FREQUENCIES AND LEVELS											
STANDARD FREQUENCY	125	250	500	750	1,000	1,500	2,000	3,000	4,000	6,000	8,000	Hz
MUSICAL FREQUENCY	131	262	523	-	1,047	-	2,093	-	4,186	-	8,372	Hz
Air conduction (THD 39)	80	100	120	120	120	120	120	120	120	110	110	dB HL
Bone conduction (B 71)	-	50	60	60	70	70	70	70	70	55	55	dB HL
Free field	-	70	80	80	80	80	80	80	80	80	80	dB HL
MASKING NOISE												
Narrow bandwidth AC	60	80	100	100	100	100	100	100	100	100	90	dB HL
Narrow bandwidth BC	-	50	60	60	70	70	70	70	70	-	-	dB HL
White AC	-	-	-	-	100	100	100	100	100	-	-	dB SPL
Speech	-	-	-	-	100	100	100	100	100	-	-	dB SPL
LOGO-AUDIOMETRY												
Air conduction	100											dB SPL
Free field	80 dB at 1m from the patient											dB SPL
Minimum levels												
All options	-10	-10	-10	-10	-10	-10	-10	-10	-10	-10	-10	dB HL

Communication system:
- Print directly to a USB printer or connect to W50 Microsoft Windows Audiometry Software.

Audiometry software:
It allows to manage patient database, display graphically results, compare tests, ... It also allows to input data performed by other audiometers, show automatic diagnosis (council IMSS, ...). Compatible Windows 10



	A	AOM	SUPRA
Audiometry type	4 screening	3diagnostic	2 clinical
Air conduction TDH 39	•	•	•
Bone conduction B71	•	•	•
Masking by white narrow band & speech noise	•	•	•
Sisi test	•	•	•
Supraliminal tests	•	•	•
Speechaudiometry + Intercom kit	optional	optional	•
Musical frequencies	•	•	•
Intercom data base	150 tests	1,000 tests	1,000 tests
USB connectivity	•	•	•
W50 audiometry software	optional	optional	•
User manual English, Italian (available on request French or Spanish)	•	•	•

PC OR PC-iPAD CONTROLLED PORTABLE AUDIOMETERS

PICCOLO PORTABLE AUDIOMETERS

Piccolo is a basic diagnostic audiometer offering air, bone and speech audiometry functions.

Piccolo can be controlled either from a computer running Windows or, for the first time ever, from an iPad®.

Lightweight, compact design, powerful, user-friendly software and Noah connectivity combine to make Piccolo the ideal choice for professionals on the move.

- three different models available:

Basic (AC only) for Pc use

Plus (AC/BC) for Pc or Pc-iPad® use (Aero version)

Speech (AC/BC/Live Speech) for Pc-iPad® use

- iPad® control (includes Aero option, 33616, 33618 only) through the Maestro App. Wireless Bluetooth connectivity

- computer control through the dedicated Noah or Daisy module. USB connection port

- small and light weight
- power supply through the USB connection, when controlled by computer.
Made in Italy.

Software language:
GB, FR, IT, ES, DE, PL, PT, RU.
CD manual and quick guide
GB, FR, IT, ES, DE, PL, PT, NL.



TECHNICAL SPECIFICATIONS

	Piccolo Basic	Piccolo Plus	Piccolo Speech
Type of device	Pc control	PC (33615) or Pc and iPad® control (33616)	Pc and iPad® control
Class EN 60645-1, ANSI S3.6	4-screening	3-diagnostic	3-diagnostic
Output	AC	AC, BC	AC, BC, Live Speech
Masking	NBN	NBN	NBN, WN, SN
Warble tone	Yes	Yes	Yes
Pulsed tone	0.5 Hz, 1 Hz, 2 Hz	0.5 Hz, 1 Hz, 2 Hz	0.5 Hz, 1 Hz, 2 Hz
Frequency range	125 - 8,000 Hz	125 - 8,000 Hz	125 - 8,000 Hz
Maximum output intensities	AC: -10 to 120 dB HL	AC: -10 to 120 dB HL BC: -10 to 80 dB HL	AC: -10 to 120 dB HL BC: -10 to 80 dB HL
Attenuator step	5 dB	5 dB	5 dB
Automatic audiometry	HW auto threshold	HW auto threshold	HW auto threshold
Speech audiometry	No	No	Yes
Speech inputs	-	-	EXT1, EXT2, Mic
Talk over	External microphone	External microphone	External microphone
Connection to PC	USB [driverless]	USB [driverless]	USB [driverless]
Controlling software	-	Daisy or Noah with Maestro module	-
Connection to iPad	-	Bluetooth 4 (only 33616)	Bluetooth 4
Controlling app	-	Maestro (App Store)	Maestro (App Store)
Dimensions	-	16x16x3cm (16.3x6.3x1.2 in)	-
Weight	300 g (10.6 oz)	300 g (10.6 oz)	300 g (10.6 oz)
Operating voltage	100-240 V, 50/60 Hz	100-240 V, 50/60 Hz	100-240 V, 50/60 Hz



code	SCREENING AND DIAGNOSTIC AUDIOMETERS	Management
33613	Piccolo Basic screening audiometer - air + mask	PC
33615	Piccolo Plus diagnostic audiometer - air + bone + mask	PC
33616	Piccolo Plus Aero diagnostic audiometer - air + bone + mask	PC + iPad
33618	Piccolo Speech Aero diagnostic audiometer - air + bone + live speech* + mask	PC + iPad

STANDARD ACCESSORIES	
- TDH-39 supra-aural headphones	- Jack/jack cable (Ø 3.5 mm) - 33618 only
- B71 bone vibrator (33615/6/8 only)	- Inventis Daisy Patient Record Manager, with Daisy Maestro module
- Patient response switch	- Noah Maestro module
- Clip-on microphone for operator-to-patient communication	- USB connection cable
	- Medical grande power supply
	- User Manual

*Speech material IT standard, available on request FR.

BELL PLUS DIAGNOSTIC AUDIOMETER

• 33635 BELL PLUS DIAGNOSTIC AUDIOMETER - air + bone + mask + software DAISY - MAESTRO

Bell is a basic diagnostic audiometer performing fast and accurate air and bone conduction threshold examinations.

Simple operation, fast and reliable automatic examination mode, user-friendly interface and easy portability make Bell the ideal instrument for private clinics, multi-specialist clinics and occupational medicine application.

- pure tone audiometry in AC and BC
- hughson-Westlake auto threshold test
- colour graphic display-
- internal memory for 100 patients
- cost effective solution

- supplied with air conduction phone and vibrator for bone conduction.

Made in Italy.

Maestro Software interface

The Maestro module is the software interface of Bell Plus audiometer. When it is connected to PC via USB you can see real time progress of the exam on the display and then download the data. It also allows full control of the audiometer from computer.



Manual:
GB, FR, IT, ES, DE, PT.

33635

STANDARD ACCESSORIES	
- TDH-39 supra-aural headphones	- Plastic cover sheet
- B71 bone vibrator	- Medical grade power supply
- Patient response switch	- User Manual

TECHNICAL SPECIFICATIONS	
Type of device	Hybrid audiometer
Class (EN 60645-1, ANSI S3.6)	3 diagnostic
Output	AC, BC
Masking	NBN, WN
Insert masking earphone	Yes
Warble tone	Yes
Pulsed tone	0.5 Hz, 1 Hz, 2 Hz
Frequency range	125 - 8,000 Hz
Maximum output intensities	AC: -10 to 120 dB HL BC: -10 to 80 dB HL
Attenuator step	5 dB
Automatic audiometry	HW auto threshold
Talk over	Internal or external microphone
Display type	Colour graphic
Display size resolution	4.3", 480x272
Internal memory	100 patients
Operating voltage	100-240 V, 50/60 Hz
Dimensions - weight	32x32x9 cm (12.6x12.6x3.5 in) - 1.8 kg (4.0 lbs)

SPIROTEL SPIROMETERS - BLUETOOTH OPTION

- 33471 SPIROTEL with WINSPIROPRO software
- 33472 SPIROTEL with Bluetooth and WINSPIROPRO software
- 33473 SpO₂ PROBE - adult - optional
- 33410 MOUTHPIECES int Ø 2,8 x ext Ø 3, h 6.5 cm

A pocket laboratory which integrates 4 devices in one:
 - spirometer with touch screen display
 - triaxial accelerometer with motion analysis for therapy monitoring
 - intelligent 3D oximeter with on screen results (with 33473)
 - e-diary for home care symptom control.
 Compatible with Qualcomm Life 2 net Hub



LCD backlit touch screen display 160x80 pixel

Manual and internal software languages: GB, FR, IT, DE, ES.

Size: 74x88x38 mm - Weight: 151 g



TECHNICAL SPECIFICATION	
Flow sensor:	Bi-directional digital turbine
Flow range:	±16L/s - ±3% or 50 mL
Dynamic resistance:	<0.5 cm H ₂ O/L/s
Measured parameters:	Reading on spirometer: FVC, FEV1, PEF, FEF 25/75
SpO ₂ range:	0-100% ±2% (50-100% SpO ₂)
Pulse rate range:	20-254 BPM ±2BPM or 2%
Data transmission:	USB 2.0 or Bluetooth
Memory capacity:	Up to 10,000 tests - 300 hours oximetry (only with 33473)
Power supply:	Lithium-ion 3.7 V, 1100 mAh rechargeable, for 40 hours measurements

DISPOSABLE AND RE-USABLE TURBINES FOR MIR SPIROMETERS

- 33507 DISPOSABLE TURBINE WITH INTEGRATED MOUTHPIECE - box of 60
 Single patient use. Low cost and high accuracy. Individually packed to guarantee maximum hygiene. Easy to replace, no calibration needed. Compatible with GIMA codes: 33509, 33511-14, 33518-22, 33527-29, 33530, 33532, 33534.
- 33526 RE-USABLE TURBINE - bayonet
 Easy to replace, no calibration needed. Compatible with GIMA codes: 33511-14, 33518, 33520-22, 33528-32, 33534.



33526 33507

MOUTHPIECES FOR MOST SPIROMETER BRANDS

Paper mouthpieces (disposable) and plastic mouthpieces (re-usable for most brands of spirometers and peak flow. Paper mouthpieces are packed in individual transparent pouch.



GIMA PAPER MOUTHPIECES					
code	Sizes - cm Ø int x ext x h	Suitable for	Compatibility		Minimum order
			GIMA codes	Other brands	
33410	2.8x3x6.5	adult	33431, 33433, 33471-2, 33512-14, 33518-22, 33528-32, 33534	Micromedical Vitalograph, Mir Ferraris (Koko legend) Cardiette (Pneumos 300) Micromedical Vitalograph, Mir	box of 500
33897					dispenser of 100
33411	2.0x2.2x6	paediatric	33411	Mir	box of 250
33412	Plastic adapter		33411	Mir	-
33506	2.6x2.8x6.5	adult	33480, 33484-7	Sibel	box of 100
33494	1.9x2.1x7	paediatric	33486, 33487	Sibel*	box of 100
33890	2.5x2.7x7	adult	-	Fukuda Sangjo, Thor	dispenser of 100
33892	2.8x3.05x7	adult	-	Cosmed (Pony model)	dispenser of 100
33898	2.8x3.05x7	adult	-	Cosmed (Pony model)	box of 500
33895	3.03x3.3	adult	-	Sensormedics, Microcard	box of 500
33899	2.42x2.6	adult	-	Sorin Lifewatch, Fukuda Denshi	box of 500
GIMA PLASTIC MOUTHPIECES					
33432	1.7x2.1x5 2.7x3x5	adult/ped	33431, 33433	Ferraris	-
33691		adult	33682-4, 6, 8	Thor	box of 10

*Gimaspir A/B need adapter 33495

SPIROMETRY PAPERS

- 33492 MIR SPIROLAB PAPER - roll 112mm x 25m
 Suitable also for SIBEL DATOSPIR 120 B, C, D, DATOSPIR Touch and GIMASPIR 120 models B, C, D.
- 33893 COSMED PONY PAPER - roll 57 mm x 11 m - box of 5 rolls
- 33894 COSMED PONY FX PAPER - roll 112 mm x 13m - box of 25 rolls
 Compatible also with Fukuda Spirosift.
- 33250 THERMAL PAPER - roll 58 mm
 Suitable for SIBEL DATOSPIR 120 A and GIMASPIR 120-A.

NOSECLIP

- 33474 NOSE CLIP



33474

BACTERIAL FILTER

- 33525 BACTERIAL FILTER - box of 50 for MIR, Medisoft spirometers
- 33557 SPIROGUARD BACTERIAL FILTER - box of 50

Compatibility of Spiroguard
 Erich Jaeger GmbH
 Ferraris Medical - P.K. Morgan
 Sensormedics
 Vitalograph
 Masterlab and Masterscreen
 Autolink-Benchmark Transflo and USA Transfer System
 2200 - 2400 - 2450
 Wedge-Bellow-Alpha and Escort Spirometers

BACTERIAL FILTER - MOUTHPIECE FOR MOST SPIROMETER BRANDS



BACTERIAL FILTER - MOUTHPIECE
 Disposable filter with anatomical shape to prevent bacterial and viral contamination. Easy to use, direct connection to spirometer one side, patient mouthpiece other side. Suitable for most of spirometers and devices. Class II A. Individually packed in transparent bag. Made in Italy.

BACTERIAL FILTERS - MOUTHPIECES - box of 100			
code	Size - cm Ø int x ext	Compatibility with	
		GIMA codes	Other brands
33884	2.75x3	33341, 33433, 33471-2, 33509-14, 33518-22, 33528-32, 33534	Micromedical, Vitalograph, Mir, Ferraris (koko legend), Cardiette (Pneumos 300)
33885	2.75x3.1	-	Cosmed
33886	2.95x3.4	-	Customed, Jaeger
33887	3.05x3.5	-	Sensormedics, BTL, Thor, Morgan, Chest, Microgard
33888	3.4x3.6	-	Medical Graphics
33889	2.5x2.7	-	Fukuda Sangjo

SMART ONE PEAK FLOW-FEV1

- **33681 SMART ONE® - Peak Flow and FEV1**

Manual in GB, FR, IT, ES, DE, PT, PL, RU, TR, CN

Ideal for monitoring respiratory illnesses and in self management of Asthma, COPD, lung transplant care, cystic fibrosis and for use in clinical trials. **Peak flow and FEV1 on your smartphone**

Simple handheld wireless device that can be easily connected via Bluetooth to iOS and Android smartphones and tablets.

App (GB, IT) with an exclusive incentive for adult and children based on exhaled flow and volume that gives accurate and helpful results. **Graphic trend of Peak Flow and FEV1**

Measurements including option to flag any test session. Test results history with Peak Flow, traffic light health indicator, symptoms scoring and notes. Low battery consumption. **New turbine flowmeter with plastic mouthpiece** for personal use, easy to remove for cleaning and hygienic. Made in Italy.

- **33896 REUSABLE MOUTHPIECE - plastic - box of 10**
- **33897 DISPOSABLE MOUTHPIECE - paper - box of 100**



CE 0476

FDA 510 (K)
Health Canada

33681



Graphic trends of Peak Flow and FEV1 which can be shared by email



TECHNICAL SPECIFICATION

General	2 batteries AAA 1.5 V included
Power supply:	1,000 tests
Autonomy:	Low energy Bluetooth® 4.0
Connectivity:	49x109x21 mm - 61 g (batteries included)
Size - weight:	Ø 30 mm (1.18 inch)
Mouthpieces:	
Spirometry	
Flow sensor:	bi-directional digital turbine
Flow range:	±16 L/s Flow accuracy: ±5% or 200 mL/s
Volume accuracy:	±3% or 50 ml
Measured parameters:	FEV1, PEF
Memory capacity:	the application on the smartphone memorizes data

LUNG EXERCISE DEVICE

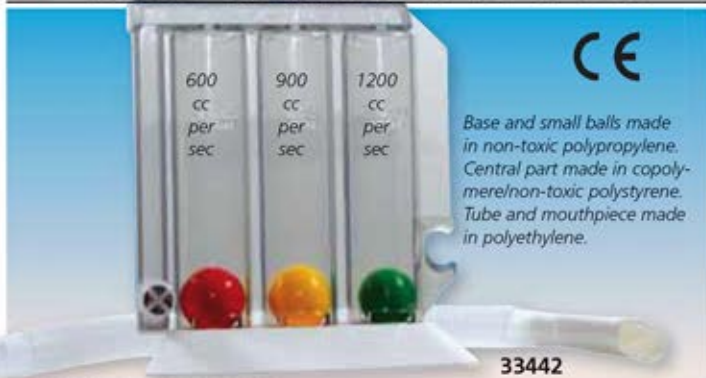

CE

Base and small balls made in non-toxic polypropylene. Central part made in copolymer/non-toxic polystyrene. Tube and mouthpiece made in polyethylene.

33442

- **33442 RESPIPROGRAM**

Device to exercise the respiration through inspiration. The respiratory-exerciser Respirogram helps the patient to recover the normal respiration after a chest or abdominal surgery. The device is composed of: 1 base, 3 small balls different in dimension and colours, 1 transparent central part divided into 3 rooms, 1 tube and mouthpiece. Each unit packed in single box. Made in Italy. User manual: GB, IT.

- **33445 TRI-BALL® - respiratory exerciser**

The respiratory-exerciser Tri-Ball® helps the patient to recover the normal respiration after a chest or abdominal surgery. Single patient. User manual in GB, FR, DE, IT, ES.



33445

600/900/1200 cc per sec

PEAK FLOW METERS



33431

CE 0473

Calibrated and graduated scale from 60 to 800 l/min BTPS
Complies with EU/ATS



Plastic mouthpiece suitable for both adults and children

- **33431 POCKET PEAK - standard 60-800 l/min - cream**

- **33433 POCKET PEAK - low 50-400 l/min - yellow**

The Pocketpeak Peak Flow Meter is designed to provide simple and reliable home asthma management.

Lightweight and easy to use, it provides accurate and reliable measurements over time.

It is easy to clean and features a universal mouthpiece.

The EU/ATS Scale Pocket peaks will not only comply with the new European Standards but also with ATS (American Thoracic Society) Standards.

Standards range pocket peak will cover 60-800 litres/min, low range will cover 50/400 litres/min.

Package includes multilingual directions for use and peak flow diary, all packed in a cardboard box. Made in USA.

Size 86x81x30 mm.

Weight 45 g. Standards: EN 13826:2003

- **33432 UNIVERSAL MOUTHPIECES - re-usable**

In plastic, sterilizable, suitable both for adults and children.

- **33410 DISPOSABLE MOUTHPIECES - box of 500**

AEROSOL HOLDING CHAMBER

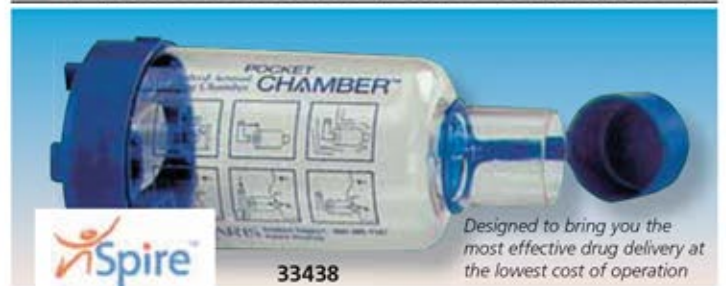

33438

Designed to bring you the most effective drug delivery at the lowest cost of operation

- **33438 POCKET CHAMBER**

Now you can manage your asthma conveniently and effectively with a truly pocket-sized device, proven as effective as MDI chambers nearly twice its size.

The Pocket Chamber delivers a high concentration of respirable aerosol, to help provide relief from asthma symptoms while capturing large particles and reducing unwanted side-effects.

- whistle alerts patients if inspiratory rate is exceeded

- effective, affordable alternative to expensive aerosol delivery

- flexible port accepts virtually any MDI's mouthpiece

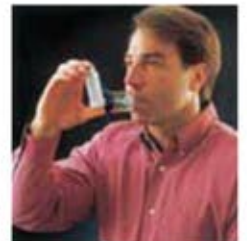

TECHNICAL SPECIFICATION

Size: 108 x 47.5 mm	Volume: 110 ml
Mouthpiece: 22 mm external Ø	Weight: 33 g
Materials: All Latex Free Silicone	Warranty: One year
User Manual: GB, FR, IT, ES, DE, PT, NL, GR, TR	Made in USA

■ SPIROBANK II SMART - PORTABLE SPIROMETER WITH SPO₂ OPTION

- **33512 SPIROBANK II SMART + WINSPIROPRO SOFTWARE**
Spirometer with 10,000 tests memory capacity, monochromatic LCD display, 6 keys membrane keypad. Battery power supply (3.7 V-1100 mA lithium) with an autonomy of approx. 50 hours of continuous use, rechargeable with USB port.
- cable (USB 2.0) or wireless (Bluetooth 4.0) connection
- internal temperature sensor for automatic BTPS conversion
- high resolution graphic display
- automatic record of a whole spirometry session including best test
- USB cable, carrying case, CD manual (GB, FR, IT, ES, DE, PT) re-usable turbine and software included. Selectable internal software (GB, FR, IT, ES, DE, PT)

- **33514 SPIROBANK II SMART + WINSPIROPRO SOFTWARE + OXYMETER**

Same as above with more than 300 hours of oximetric test records (SpO₂ % and pulse frequency tests).
Measured parameters: min, max and average SpO₂ %, min, max and average pulse frequency, SpO₂ total events, test duration, bradycardia events (<40 BPM), tachycardia events (>120 BPM), T90% (time passed with SpO₂ ≤89%), T89% (time passed with SpO₂ ≤ 88%)

- **33525 ANTIBACTERIAL FILTER - box of 50 disposable**
- **33507 DISPOSABLE TURBINE with mouthpiece - box of 60**
- **33526 REUSABLE TURBINE**
- **33410 MOUTHPIECES int. Ø 2.8 x ext. Ø 3, h 6.5 cm**

TECHNICAL SPECIFICATIONS - SPIROMETRY

Measured parameters FVC, FEV1, FEV1/FVC%, DTPEF, FEV0.5, FEV0.5/FVC%, FEV0.75, FEV0.75/FVC%, FEV2, FEV2/FVC%, FEV3, FEV3/FVC%, FEV6, FEV1/FEV6%, PEF, FEF25%, FEF50%, FEF75%, FEF75-75%, FEF75-85%, FET, Vext, Lung Age, EVOL, FIVC, FIV1, PIF, FIV1/FIVC%, FIF25%, FIF50%, FIF75%, R50, PIF, IRV, VC, IVC, IC, ERV, FEV1/VC%, VT, VE, Rf, ti, te, ti/t-tot, VT/ti, MVV	Flow sensor bi-directional digital turbine Flow range ±16L/s Volume accuracy ±3% or 50 mL Flow accuracy ±5% or 200 mL/s Dynamic resistance <0.5 cm H ₂ O/l/s Available tests: FVC, VC, IVC, MVV, PRE - POST Connectivity USB 2.0, Bluetooth® 4.0 Power supply Lithium-Ion 3.7V, 1100 mAh
---	--

TECHNICAL SPECIFICATIONS - OXYMETRY (33514 only)

Measurement method: red and infrared absorption SpO ₂ range: 0-99% ±2 % between 70-99% SpO ₂ Pulse rate range: 18-300 BPM ±2 BPM or 2%	Signal quality indicator: 0-8 segments on display Memory capacity: up to 300 hours oximetry
--	--

- WinspiroPRO software functions:**
(GB, FR, IT, DE, ES, PT, PL, SE, NL, LV, CZ, TR, RU, CN, JP)
- on-line PC connection with icon interface
 - real time Flow/Volume and Volume/time curves
 - bronchial challenge with FEV1 dose-response
 - paediatric incentive animations
 - integration with EPR systems
 - Lung Age Estimation
 - data and graphs export also via e-mail
- PC system requirements:
XP, Seven, Vista, 8, 10



FDA 510 (K)
CE 0476
Health Canada

■ SPIROBANK II BASIC

CE 0476
FDA

Size: 160x55x25 mm
only 140 g including battery



System requirements: Microsoft Windows
Vista, 2000, XP, ME, Seven, 8, 10

- **33510 SPIROBANK II BASIC + WINSPIROPRO software**
Complete and rapid pocket spirometer for the General Practitioner to carry out spirometry testing anywhere.
No calibration required, use disposable turbine FlowMIR with integrated mouthpiece (33507) or reusable turbine (33526).

- measures the most important spirometric parameters including: FVC, VC, IVC, IC, ERV, FEV1, FEV1%, PEF, FEF 25-75, FET, EVOL, TEST POST BD
- traffic lights for immediate test interpretation
- memory up to 10,000 tests
- rechargeable long life battery (40 hours continuous operation)
- real time tests via USB
- selectable display language and CD manual (GB, IT, ES, FR, DE, PT)

- Supplied with Winspiro PRO software, USB cable, 1 disposable turbine in a carrying bag.
- **33507 FLOWMIR DISPOSABLE TURBINE with integrated mouthpiece - box of 60 - spare**
- **33526 REUSABLE TURBINE - optional**

TECHNICAL SPECIFICATION

Power supply: 3.7 V, 110 mA lithium battery , USB rechargeable	Keypad: 6-key membrane keyboard	Display: LCD monochrome 160x80 pixel
Flow range: + 16 l/s	Flow accuracy: ± 5% or 200 ml/s whichever is greater	
Max volume: 10 l	Volume accuracy: ± 3% or 50 ml whichever is greater	
Data transmission: USB 2.0	Made in Italy	

■ SPIROBANK G WITH SOFTWARE

CE 0476

Graphic display
(128x48 pixels) with user friendly icons

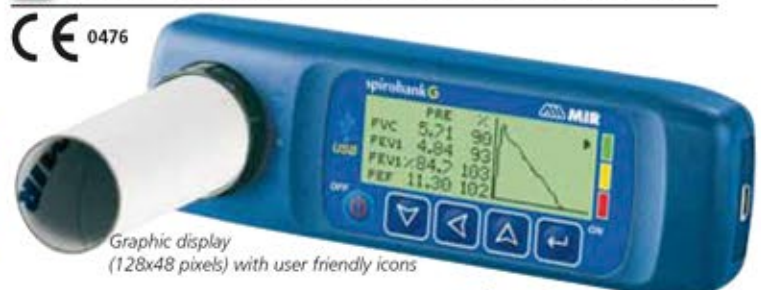

- **33518 SPIROBANK G + WINSPIROPRO software**

- stand alone spirometer with PC online operation
 - 6,000 spirometry in memory
 - high legibility graphic display
 - FVC, VC, IVC, MVV, PRE-POST BD
 - advanced spirometry test interpretation
 - Lung Age Estimation (ELA)
 - ready for Telemedicine applications
 - internal temperature sensor for automatic BTPS
 - upgradable internal software via internet
- Standard package includes USB cable, pouch, noseclip, battery, re-usable turbine and Winspiro PRO software.

TECHNICAL SPECIFICATION

Measured parameters: FVC, FEV1, FEV1/FVC%, FEV3, FEV3/FVC%, FEV6, FEV1/FEV6%, PEF, FEF25%, FEF50%, FEF75%, FEF75-75%, FET, Vext, Lung Age, FVC, FIV1, FIV1/FIVC%, PIF, VC, IVC, IC, ERV, FEV1/VC%, VT, VE, Rf, ti, te, ti/t-tot, VT/ti, MVV
Temperature sensor: semiconductor (0-45 °C)
Flow sensor: bi-directional digital turbine
Max volume: 10 l
Flow range: ± 16 l/s
Volume accuracy: ± 3% or 50 ml, whichever is greater
Flow accuracy: ± 5% or 200 ml/s, whichever is greater
Dynamic resistance at 12 l/s: <0.5 cm H₂O/l/s
Power supply: 9V DC (PP3 battery)
Weight: 180 g (with battery)
Made in Italy

WinspiroPRO PC system requirements

- (GB, FR, IT, DE, ES, PT, PL, SE, NL, LV, CZ, TR, RU, CN, JP)
- Microsoft Windows: Vista, 2000, XP, Me, Seven, 8
- Screen resolution: 1024x768
- Hard disk space: 160 MB

Internal software and CD manual: GB, FR, IT, ES, DE, PT (only manual)

SPIROMETER + OXIMETER + 3D ACCELEROMETER IN ONE UNIT

SPIRODOC® - SPIROMETER AND OXIMETER

- 33532 SPIRODOC SPIROMETER + SOFTWARE WINSPIRO PRO - bluetooth
- 33533 SPIRODOC OXIMETER + SOFTWARE WINSPIRO PRO
- 33534 SPIRODOC SPIROMETER + OXIMETER + SOFTWARE - bluetooth

One touch laboratory for respiratory analysis suitable for professional and personal use.

Complete spirometer ATS/ERS compliant

Specialist-level analysis, screening and Home-care monitoring. It has been developed with various operation modes:

"advanced" parameters for the specialist, "reduced" set of parameters for screening as well as a "simplified" version for Home-care operation. FVC, VC, IVC, MVV, PRE-POST.

Precise spirometry interpretation including post bronchodilator. All tests are automatically memorized. Automatic BTPS conversion. Memory capacity: 10.000 tests. Wide selection of predicted values.

Intelligent pulse oximeter with on-screen results

Simple, clear SpO₂ and Pulse Rate measurements with plethysmographic curve. During the single six-minute walk test (6 MWT), Spirodoc® estimates the level of oxygen therapy required by the patient. Spirodoc® carries out sleep desaturation studies and memorizes events as well as body position.

3D Accelerometer with motion analysis

Spirodoc® is the first 3D Oximeter® incorporating a triaxial motion sensor to correlate the saturation level (%SpO₂) with physical activity (walk counter, movement analysis and VMU).

Home-care symptoms diary

Fast on-screen symptoms entry. Touch screen with settable questions and automatic answer recording for homecare patient use (eDiary).

High performance PC software for spirometry and oximetry

All tests memorized in Spirodoc® are automatically downloaded into WinspiroPRO and a patient data card is created with a preview of the spirometry curve. WinspiroPRO can easily be connected to a database, EPR, hospital or occupational health system. This software also gives trend graphs of any parameter. All stored tests and curves of every patient can be reviewed on a single page



33534

Easy touch-screen display

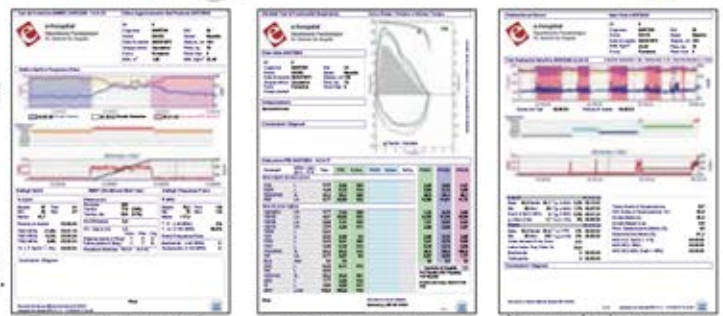

Three phase report of 6 minutes walk test: baseline, walk, recovery

Spirometry report

Nocturnal oximetry report with desaturation analysis

and the results, including oximetry tests, can be compared. Supplied with reusable turbine. Multilanguage software: GB, FR, IT, ES, DE, PT, PL, NL SE, CZ, LV, TR, RU, CN, JP.

TECHNICAL SPECIFICATIONS

Central unit

Display: LCD backlit touch screen display 128x64 pixels
 Power supply: Lithium ion 3.7 V, 1100 mA rechargeable battery with 50 hours measurement back up
 Accelerometer: Triaxial ±2 g, 400 Hz sampling
 Dimension and weight: central unit 101x48x16 mm, 99 g removable turbine head: 46x47x24 mm, 17 g
Spirometry
 Flow sensor: Bi-directional digital turbine
 Flow range: ±16 L/s
 Volume accuracy: ±3% or 50 mL, whichever is greater
 Flow accuracy: ±5% or 200 mL, whichever is greater
 Dynamic resistance at 12 L/s: <0.5 cm H₂O/L/s

Temperature sensor: semiconductor (0-45°C)

Spirometer measured parameters

FVC, FEV1, FEV1/FVC%, FEV3, FEV3/FVC%, FEV6, FEV1/FEV6%, PEF, FEF25%, FEF50%, FEF75%, FEF25-75%, FET, Estimated Lung Age, Extr. Vol., FIVC, FIV1, FIV1/FIVC%, PIF, VC, IVC, IC, ERV, FEV1/VC%, VT, VE, Rf, ti, te, ti/t-tot, VT/ti, MW measured, MW calculated

Oximetry

SpO₂ range: 0 - 100%, ±2% (50-100% SpO₂)
 Pulse rate range: 20-254 BPM, ±2 BPM or 2%

Pulseoximeter measured parameters

SpO₂ [Baseline, Min, Max, Mean], Pulse rate [Baseline,

Min, Max, Mean], T90% [SpO₂<90%], T89% [SpO₂<89%], T88% [SpO₂<88%], T5% [ΔSpO₂>5%], Δindex [12s], SpO₂ events, Pulse rate events [Bradycardia, Tachycardia], Step counter, Movement [VMU], Recording time, Analysis time
Sleep analysis
 Body position, SpO₂ events, Desaturation index (ODI), Desaturation [Mean Value, Mean duration, Longest duration, Nadir Peak], ΔSpO₂ [Min Drop, Max Drop], Total Pulse Variations, Pulse Rate Index, NOD89% [SpO₂<89%; >5min], NOD4% [SpO₂ Basale-4%; >5min], NOD90% [SpO₂<90%; Nadir<86%; >5min]

MINISPIR® LIGHT

- 33527 MINISPIR with Winspiro Light
- Minispir Light measures 10 essential parameters for a diagnostic spirometry: FEV6, FVC, FEV1, FEV1%, PEF, FEF25/75%, FIVC, Lung Age, VC, IVC. Pediatric incentives. Flow/Volume loop and Volume/Time curve. Spirometry test interpretation.

Temperature sensor for BTPS conversion. Minispir Light meets the requirements of integrated healthcare platforms and tablet applications. For use with FlowMir disposable turbine only (33507).

Winspiro Light is an intuitive and efficient software, for complete diagnosis included in Minispir Light.

FOR ESSENTIAL RESPIRATORY TESTING

AND MINISPIR®-USB

- 33528 MINISPIR with Winspiro PRO
 - 33529 MINISPIR+OXYMETER with Winspiro PRO
- Real time Flow/Volume loop and Volume/time curve with PRE/POST comparison. Advanced spirometry test interpretation. Pediatric incentive animations. Lung Age. Bronchial provocation test including new Mannitol protocol with FEV1 response curve. Temperature sensor for BTPS conversion. Supplied with reusable turbine.

32 measured parameters: FVC, FEV1, FEV1%, FEV3, FEV3%, FEV6, FEV1/FEV6%, PEF, FEF25%, FEF50%, FEF75%, FEF25-75%, FET, Vext, Lung Age, FIVC, FIV1, FIV1%, PIF, VC, IVC, IC, ERV, FEV1/VC%, VT, VE, Rf, ti, te, ti/t-tot, VT/ti, MVV.

FOR COMPLETE RESPIRATORY ANALYSIS

PC SYSTEM REQUIREMENTS FOR WINSPIRO LIGHT/PRO
 Microsoft Windows: XP, Vista 32/64 bit, Seven 32/64 bit, 8
 Screen resolution: 1024x768 Hard disk: 128 MB (better 256 MB)
 USB socket
 Multilanguage: GB, FR, IT, ES, PT, DE, PL, SE, NL, CZ, LV, TR, RU, CN, JP

33529 PC not included

Winspiro PRO is a unique spirometry and oximetry software, which comes standard with Minispir. All patient records are shown on simple, single-screen patient cards with dynamic management of all data and graphs.

TECHNICAL SPECIFICATIONS

MINISPIR/MINISPIR LIGHT

Temperature sensor: semiconductor (0-45°C)
 Flow sensor: bi-directional digital turbine
 Flow range: ± 16 L/s
 Volume accuracy: ± 3% or 50 mL
 Flow accuracy: ± 5% or 200 mL/s
 Dynamic resistance at 12 L/s: <0.5 cm H₂O/L/s
 Communication port: USB
 Power Supply: line powered from USB port
 Dimension: 50x142x26 mm
 Weight: 65 g

TECHNICAL SPECIFICATIONS

MINISPIR SpO₂

SpO₂ range: 0-99%
 SpO₂ accuracy: ± 2% tra 70-99% SpO₂
 Pulse Rate range: 30-300 BPM
 Pulse Rate accuracy: ± 2 BPM or 2%
Measured parameters
 SpO₂ [Baseline, Min, Max, Mean], Pulse Rate [Baseline, Min, Max, Mean], T90 [SpO₂<90%], T89 [SpO₂<89%], T88 [SpO₂<88%], T5 [ΔSpO₂>5%], Δ Index [12s], SpO₂ Events, Pulse Rate Events [Bradycardia, Tachycardia]

code	SPARE PARTS AND ACCESSORIES
33507	Flowmir disposable turbine with integrated mouthpiece - box of 60
33410	Adult mouthpieces Ø ext 3 cm - box of 500 pieces (only for 33526)
33526	Reusable turbine (only for 33528-9)

SPIROLAB III - DIAGNOSTIC SPIROMETER WITH SPO₂ OPTION



LCD Colour display
240x320 pixel,
size 90x120 mm

Printer

PEDIATRIC INCENTIVE SYSTEM

HIGH DEFINITION LCD

DATABASE FOR 6,000 TESTS

USB

ATS Certified

ERS Standard

Mini flowmeter

• 33521 SPIROLAB III - diagnostic spirometer with high resolution colour display, built-in printer and PC WINSPIROPRO software

• 33522 SPIROLAB III same as 33521 with SpO₂

A really complete spirometry system:

- FVC, VC with breathing pattern plus MVV tests with real time curves
- over 30 parameters with **automatic interpretation** and test quality control
- PRE/POST bronchial response protocol with F/V loop comparison
- up to 8 blows curve on one screen
- internal database for about 6,000 complete tests
- predicted values with various authors
- rechargeable battery plus mains power 220 V, 50-60 Hz (110V on request)
- user-friendly keyboard with dedicated function keys plus alphanumeric data entry
- internal temperature sensor for automatic BTPS conversion
- free upgradable internal software from web, maintaining previously stored data
- selectable multilanguage internal software (GB, FR, IT). Possibility to order also with following internal languages: DE, ES, PL, PT, RU, CN, TR.

Finger Oximeter (33522 only)

- short or long term (overnight) SpO₂ and Pulse Rate measurements
- ODI, NOD, T90%, T89%, T88, T87%
- oximetry during exercise test

• 33410 ADULT MOUTHPIECES - Ø 3 cm ext - box of 500 pcs.

• 33492 THERMAL PAPER - 112 mm x 25 m

• 33515 SpO₂ PROBE - adult - spare

• 33516 SpO₂ PROBE - paediatric

• 33525 ANTIBACTERIAL FILTER - disposable - box of 50 pcs.

• 33507 DISPOSABLE TURBINE WITH INTEGRATED MOUTHPIECE - box of 60

• 33524 CONNECTION CABLE MINIFLOWER-SPIROLAB III (532370) - spare

• 33523 CONNECTION CABLE MINIFLOWER-SPIROLAB and SPIROLAB II (532375) - spare

33521, 33522 Connection cable (33523-4)

Only 1.9 kg for truly portability

WinspiroPRO software included (GB, FR, IT, DE, ES, PT, CZ, SE, NL, PL, LV, TR, RU, CN, JP)

SpO₂ probe included with 33522

Quality spirometry, precise measurement
The proven MIR digital turbine flow sensor requires **no calibration** and complies with ATS 24I26 waveforms.
Certified by Dr. Crapo at LDS Hospital, Salt Lake City - Utah



Carrying case
Battery charger
1 roll thermal paper

STANDARD ACCESSORIES

Software Winspiro PRO.
USB port and cable
CD manual: GB, FR, IT, ES, DE, PT

Nose clip
Reusable turbine (33526)

TECHNICAL SPECIFICATIONS 33521-33522

Flow/volume range: ± 16 l/s
Volume accuracy: ±3% or 50 ml
Flow accuracy: ±5% or 200 ml/s
Dynamic resistance: <0.8 cm H₂O/l/s
Dimensions: 310x205x65 mm
Parameters: FVC, FEV1, FEV1/FVC%, FEV3, FEV3/FVC%, FEV6, FEV1/FEV6%, PEF, FEF25-75%, FEF25%, FEF50%, FEF75%, FET, Vext, *FVC, *FEV1, *PEF, PIF, FIVC, FIV1, FIV1/FIVC%, VC, IVC, ERV, IC, FEV/VC%, VT, VE, Rf, Ti, Te, Ti/T-tot, VT/Ti, MVV * : Best value
PC System requirements: Windows 2000, ME, XP, Seven, Vista, 8.
Made in Italy.

SP-10 POCKET SPIROMETER



AVAILABLE WITH BLUETOOTH

33536

• 33536 SP-10 POCKET SPIROMETER

• 33535 SP-10 POCKET SPIROMETER WITH BLUETOOTH

Pocket, portable spirometer with large TFT screen to clearly display both numbers and flow charts.

Synchronously measure FVC, PEF, FEV1, FEV1%, FEF25, FEF2575, FEF75.

Support diagnosis evidence by volume and flow rate chart display. Built-in predicted values.

Built-in lithium rechargeable battery and battery power display. Supplied with USB cable for PC connection, battery charger and software to calculate data and analyse trend.

• 33410 ADULT MOUTHPIECES - Ø 3 cm ext. - box of 500 pcs

TECHNICAL SPECIFICATIONS

Max volume: 10 l
Flow range: 2 l/sec - 16 l/sec
Volume accuracy: ±3% or 50 ml whichever is greater
Flow accuracy: ±5% or 200 ml/sec whichever is greater
Parameters: FVC, FEV1, PEF, FEV1%, FEV25, FEF2575, FEF75
Made in PRC
CE 92/42 - EMC group I class B - protection type BF

STANDARD ACCESSORIES

Internal lithium battery
USB cable
PC software (english language)
User manual: GB, IT, ES.



SPIROLAB SPIROMETER: 7" TOUCHSCREEN AND SPO₂ OPTION



Miniflowmeter for reusable and disposable turbine (Ø 30 mm)

CE 0476
 FDA 510 (K)
 Health Canada

- 7" TOUCHSCREEN DISPLAY
- PEDIATRIC INCENTIVE SYSTEM
- DATABASE FOR 10,000 TESTS
- USB 2.0, BLUETOOTH 2.1

33519

- 33519 SPIROLAB® SPIROMETER WITH 7" TOUCHSCREEN
 - 33520 SPIROLAB® SPIROMETER WITH 7" TOUCHSCREEN AND SpO₂
- Fast, simple, durable diagnostic spirometer, made in Italy.

Unbeatable features

- FVC, VC, MVV, PRE/POST Bronchodilator comparison with a wide range of selectable parameters
- long life rechargeable battery
- colour Touchscreen 7" display
- direct connection to external USB Printer PostScript
- 10,000 Spirometry tests or 500 hours of oximetry recording
- wireless Real Time test on PC via Bluetooth®
- fast and silent built-in B/W printer with customizable printout format
- selectable internal software languages: GB, FR, IT, ES, DE, PT

Oximetry option

Available adult and pediatric reusable finger probe.

Fast and user friendly

Each function can be activated by a simple touch.

FlowMIR® disposable turbine - complies with ATS/ERS standard
 Totally disposable (mouthpiece, turbine) guarantees 100% hygiene, no cross contamination. No calibration required. Suitable also for pediatric use without need of adaptor.



Each turbine is factory calibrated with a computerized system and is individually packaged in a clean room

33507

code	MIR code	ACCESSORIES AND SPARES	Minimum order
33695	919024	SpO ₂ probe - adult - spare	
33696	939006 + 919200	SpO ₂ probe - paediatric	
33697	910595	Miniflowmeter with cable - spare	
33410	-	Adult mouthpiece - Ø 30 mm ext	box of 500
33492	-	Thermal paper - 112 mm x 25 m	-
33525	-	Antibacterial filter - disposable	box of 50
33507	910004	Disposable turbine with integrated mouthpiece	box of 60

TECHNICAL SPECIFICATIONS - OXIMETRY (33520 only)

- SpO₂ range: 0-99%
- SpO₂ accuracy: ± 2% between 70-99% SpO₂
- Pulse Rate range: 18-300 BPM
- Pulse Rate accuracy: ± 2BPM or 2% whichever is greater
- Memory capacity: up to 500 hours oximetry

OXIMETRY PARAMETERS (33520 only)

%SpO₂ and Pulse Rate (Min, Max, Average), Test duration, Total SpO₂ Events, T90% (SpO₂ time ≤89%), T89% (SpO₂ time ≤88%), T40 (Bradycardia duration with Pulse Rate <40 BPM), T120 (Tachycardia duration with Pulse Rate >120 BPM)

Suitable for children

Patented pediatric incentive directly on the screen.



WinspiroPRO®

High performances PC software for spirometry and oximetry with free update. Multilanguage software: GB, FR, IT, ES, DE, PT, PL, NL, LV, SE, CZ, RU, TR, JP, CN.



Summary of all tests carried out



Printout: spirometry report

STANDARD ACCESSORIES

- Carrying case
- Battery charger
- 1 roll thermal paper
- Reusable turbine
- Nose clip
- Software WinspiroPRO®
- USB port and cable
- SpO₂ adult sensor (33520 only)
- CD manual: GB, FR, IT, ES, DE, PT



TECHNICAL SPECIFICATIONS - SPIROMETRY

- Power supply: Rechargeable battery
- Autonomy: approx. 10 hours
- Temperature sensor: semiconductor (0-45°C)
- Flow sensor: bi-directional digital turbine
- Flow range: ±16L/s
- Volume accuracy: ±3% or 50mL
- Flow accuracy: ±5% or 200mL/s
- Dynamic resistance: <0.5 cm H₂O/L/s
- Connectivity: USB 2.0, Bluetooth® 2.1
- Display: 7" colour touch screen LCD, 800x480 resolution
- Mouthpieces: Ø 30 mm (1.18 inch)
- Dimensions: 220x210x51 mm (8,66x8,26x2")
- Weight: 1450 g (battery pack included) (3,1lb)
- Electrical protection: Class II
- Norms: Electrical safety standard EN 60601-1
Electromagnetic compatibility EN 60601-1-2

SPIROMETRY PARAMETERS

FVC, FEV1, FEV1/FVC, FEV1/VC, PEF, FEF25, FEF50, FEF75, FEF25-75, FEF75-85, Lung Age, Extrapolated Volume, FET, Time to PEF, FEV0.5, FEV0.5/FVC, FEV0.75, FEV0.75/FVC, FEV2, FEV2/FVC, FEV3, FEV3/FVC, FEV6, FEV1/ FEV6, FEV1/PEF, FEV1/FEV0.5, FIVC, FIV1, FIV1/FIVC, PIF, FIF25, FIF50, FIF75, FEF50/FIF50, VC, IVC, IC, ERV, IRV, Rf, VE, VT, tl, tE, VT/lt, tE/tTOT, MVV (measured), MVV (calculated).

WINSPIROPRO® REQUIREMENTS

Windows 2000, Xp, Vista (32/64 bit), 7 (32/64 bit), 8 and 8.1 (32/64 bit), 10 (32/64 bit). RAM 512 MB

ULTRASONIC, DISINFECTABLE SPIROMETERS

- 33682 OTTHON SPIROMETER US (English) + SOFTWARE
- 33683 OTTHON SPIROMETER IT + SOFTWARE
- 33684 OTTHON SPIROMETER OTHER LANGUAGES + SOFTWARE

Size: 35x120x120 mm
Weight: 300 g

Pulmonary function diagnostics and monitoring spirometer for use by general practitioners, respiratory physicians and patients. Compact, mobile, affordable solution for screening COPD (Chronic Obstructive Pulmonary Disease) and asthma.

- automated diagnostic interpretation
- voice and video explain use of device and communicate results
- battery or USB charger
- touchscreen, bright colour high resolution LCD display QVGA (320x240 px), 16 M colours
- external printer connectivity
- automatic internal calibration
- flow tube disinfectable by cold sterilization
- power supply: USB 5 V or built in rechargeable battery

Internal software languages: GB, FR, IT, DE, ES, HU, AU, HR.
Voice languages available: US (English), AU, FR, IT, DE, ES, AT, HU.
Please indicate requested language with order.
Made in Europe.



FVC, MW AND VC MEASUREMENT

Size: 40x60x150 mm
Weight: 300 g



- 33688 SPIROTUBE PC SPIROMETER + SOFTWARE
- 33689 SPIROTUBE B SHOCK AND WATER PROOF PC SPIROMETER + SOFTWARE

PC based pulmonary function diagnostics and monitoring spirometer with ultrasonic ldegen™ respiratory sensor. Suitable for screening COPD and asthma.

- automatic internal calibration
- tele-medical connection via internet
- plug & play USB PC connection detection
- easy upgrade, standard interfaces, XML, HL7
- long-term monitoring for life-long patient support
- pharmaceutical testing subsystem
- flow tube disinfectable by cold sterilization

Spirotube B Edition for harsh conditions
Features an exceptionally robust design for harsh condition and heavy use.

Power supply: USB 5 V. Made in Europe.

- 33686 SPIROTUBE MOBILE EDITION BLUETOOTH SPIROMETER

Pulmonary function diagnostics and monitoring spirometer with Bluetooth communication interface and built in rechargeable battery. Suitable for screening COPD and asthma.

- wireless connection to mobile phones, PDAs, android systems. Real-time measurement with FVC curve visible on the mobile screen
- plug & play USB connection to PC
- automatic internal calibration
- tele-medical connection via Bluetooth
- automated medical interpretation
- long-term monitoring for home care use
- pharmaceutical testing subsystem
- flow tube disinfectable by cold sterilization
- software can be freely downloaded from Google Play Store



Spirotube mobile edition connects to Android based systems turning these devices into respiratory diagnostic stations

Size: 27x60x150 mm
Weight: 300 g



WATER PROOF SHOCK PROOF

	STANDARD ACCESSORIES		
	33682/3/4	33686	33688
Thorsoft software	•	•	•
Plastic mouthpieces	•	•	•
Mini USB cable	•	•	•
Cups for disinfection	•	•	•
Battery charger	•	•	•
Bacterial filter	•	•	•
Carrying bag	•	•	•
Paper manual (GB)	•	•	•
CD manual (GB, IT, ES, DE, HU)	•	•	•

TECHNICAL SPECIFICATIONS	
Flow measurement principle	ldegen™ multiple-path
Flow tube diameter	30 mm (OD)
Dead space	16.8 ml
Flow resolution	3 ml/s (33686), 8 mb/s (33682-4, 33688)
Flow precision	2% (33686, 33688), 3% (33682-4)
Flow range	±18 l/s
Connection to PC	USB

MEASURED PARAMETERS	
FVC, -FEV*0.5, FEV*0.5/IVC, FEV*0.5/FVC, FEV*1.0/IVC, FEV*1.0/FVC, PEF, FEF*25-75%, MEF*75%, MEF*50%, MEF*25%, FET, MTT, FIVC, FIV*0.5, FEV1/FVC (Tiffeneau index) FIV*1.0, PIF, FIF*25-75%, IRV, ERV, TV, Breath rate value	- Insp./Expi ratio: From 1:10 to 10:1

REGISTRATIONS

All spirometers are CE marked and registered in Indonesia, Singapore, Hong Kong, Australia, New Zealand, Korea, Saudi Arabia.

THORSOFT - PULMONARY DIAGNOSTIC PC SOFTWARE

Standard medical interfaces (HL7, GDT, BDT, XML).
Automatic interpretation module.
Diagnostic decision support system (for general practitioners and physicians)
Complete stress testing procedure
Languages: GB, FR, IT, DE, ES, SE, TR, RO, HU, SL, CZ, HR, NL, KR, CN.



code	ACCESSORIES	Minimum order
33690	Instrumed disinfectant concentrate 1 l (Bactericidal, fungicidal, virucidal, sporocidal, tuberculocidal)	
33691	Plastic mouthpieces	box of 10
33890	Disposable mouthpieces	box of 100
33692	Loki Green single use bacterial filter	box of 50
33505	Calibration syringe 3 l*	

* Ultrasonic spirometers do not need calibration. Syringe is only for check if requested by law.

SLEEP APNEA SCREEN METER

• 33676 SLEEP APNEA SCREEN METER

Suitable for people who have obstructive sleep apnea-hypopnea syndrome (OSAHS), chronic obstructive pulmonary diseases (COPD), asthma, vascular disease or people over 60 years old. For hospital and home use.

Features:

- wrist-design, small in volume and light in weight
- integrate multi-function in one device, convenient to know more physiological information
- displays SpO₂, PR, pulse sound, bar graph
- display of pulse and nasal airflow waveform
- alarm for low-power, finger-out and over-limit
- adjustable screen brightness
- real-time clock
- auto-power on/off
- multi-care record
- record data in continuous 20 hours
- upload data by USB to PC
- PC analysis software



33676

• 33677 RUBBER ADULT SpO₂ PROBE for day

• 33678 NON-WOVEN SpO₂ PROBE for night - bag of 2

• 34172 NASAL OXYGEN CANNULA

STANDARD ACCESSORIES

Adult, Neonatal disposable SpO ₂ probe	Adapter
Adult SpO ₂ probe	USB cable
Software	Nose-oxygen tube
Manual (GB, IT)	



33676

CE 0123

TECHNICAL SPECIFICATIONS

Nasal airflow measure range:	0-40 rpm ± 2 rpm
SpO ₂ measuring range:	0-100 % ± 2 % (70-100 %), resolution 1%
Pulse Rate measuring range:	30-250 bpm ± 2 bpm or ± 2% (select the larger)
Resistance to surrounding light:	The difference between the value measured in the condition of man-made light and indoor natural light and that of darkroom is less than ± 1 %
Display:	1.8" colour OLED
Power consumption:	≤ 70 mA
Power supply:	3.7 V rechargeable lithium battery
Battery working hour:	continuously work for more than 20 hours
Safety Type:	Internally powered, Type BF applied part
Dimension of device:	69x50x17.3 mm
Weight:	100 g (lithium battery included)

BREATHCARE PAP DEVICES: CPAP AND AUTO CPAP



53700

CE 0123



53701

• 53700 BREATHCARE PAP DEVICE - CPAP

• 53701 BREATHCARE PAP DEVICE - CPAP/AUTO CPAP

The breathcare PAP devices take care of patients every night. PAP (Positive Airway Pressure) device works as an air compressor, it constantly blows pressurized air to patient's airway, to prevent airway collapse.

The PAP devices contain CPAP, Auto CPAP and BiPAP.

CPAP: Continuous Positive Airway Pressure device

Auto CPAP: Automatic Continuous Positive Airway Pressure device

BiPAP: Bi level Positive Airway Pressure device

Improve sleep quality immediately

No trauma, safe and comfortable

User friendly with little discomfort

Quiet, noise ≤ 28 dB

Ultra quiet thanks to 4 methods for reducing noise level.

Stable 20,000 hours life time.

Comfortable based on years of clinical data it effectively reduces the average treatment pressure and provides a comfortable therapy experience.

yuwell

Connection with oxygen concentrator to supply oxygen with mask which can help ease symptoms of hypercapnia.

Internal software: GB, IT

Supplied with carrying bag, 2 filters, air hose, heated humidifier, breathing hose mask, SD card (only 53701), power adapter, power cable and manual (GB, IT)

• 53704 AIR SOFT TUBE

• 53705 BREATHING NOSE MASK

• 53706 AIR COTTON FILTER - box of 10

Advised replacement every 2-3 months

• 53707 CONNECTOR to oxygen concentrator



53705

TECHNICAL SPECIFICATIONS

Treatment mode:	CPAP, Auto CPAP (53701 only)
Pressure range:	4-20 cm H ₂ O
Pressure accuracy:	± 0.5 cm H ₂ O
Time-lapse boosting:	0-45 min
Alarm protection:	face mask fell alarm
Operating power:	100-240 V, 50-60 Hz DC 24 V
Automatic altimetric compensation:	3500m
USM air circuit system:	ultra silence air circuit system
PCM:	noise removal technology
3A self adapting frequency adjustment technique	
Size - weight:	27x13.5xh 10 cm - 1.5 kg



Separable body



Medical humidifier for 1 day line



3.5 inches LCD screen



Portable bag

SINGLE CHANNEL PALM ECG: CARDIO-A AND CARDIO-B

CE 0123



33259

CE 0476



33260

**4 MEASUREMENT MODES:
PALM, LEG, CHEST,
TRADITIONAL**

PALM ECG'S are designed for general practitioners or for domestic users who suffer from cardiovascular diseases such as hypertension, coronary disorders, giving the possibility of a daily ECG test. Records can be saved and used as a reference for clinical applications. **4 measurement modes: palm, leg, chest or lead wire traditional measurement.**

Main features:

- small, portable and easy to use
 - 30 second ECG waveform and measurement results
 - 600 (CARDIO-A) or 1200 (CARDIO-B) ECG waveform can be saved
 - 5 hours (CARDIO-A) or 10 hours (CARDIO-B) ECG continuous measurement data storage
 - analysis and report of 8 types (CARDIO-A) and 17 types (CARDIO-B) of ECG waveform
 - USB 2.0 interface with option data cable and ECG viewer software
 - traditional measurement with optional ECG cable
- CARDIO B with Bluetooth module for wireless data transmission.** Allows to download data on your smartphone or tablet, compatible with Android.
Supplied with multilanguage manual and box (GB, FR, IT, ES).

PALM ECG		
code		
33260	CARDIO-A palm ECG	
33261	CARDIO-B palm ECG - colour display	
33259	CARDIO-B Bluetooth palm ECG+viewer software	
ACCESSORIES		
33265	ECG viewer software+USB 2.0 cable - for 33260, old 33261	
33249	ECG viewer software + USB 2.0 cable for new 33261 since SN: XXS02JL01044 - Jan 2014	
33248	New ECG 3 pin lead cable - 3 leads - optional - 2012 from SN: XXQ00HJ03925 for 33260 from SN: XXS02HL01709 for 33261	
33264	Old ECG banana lead cable - 3 leads - optional	
TECHNICAL SPECIFICATIONS		
	CARDIO A	CARDIO B
ECG bandwidth:	0.5 Hz - 40 Hz	1 Hz - 40 Hz
Heart rate measuring range:	30 - 240 bpm ± 2 bpm	
LCD back light display:	128x64 dot matrix	240x160 dot matrix
Display size:	49x25 mm	57.6x40 mm
Power:	2xAAA batteries	
Dimensions	115x58x18 mm	125x70x21.5 mm
Weight	65 g	106 g

CARDIO-C: 3 CHANNEL POCKET ECG

iHealth
Bluetooth ECG
see page 4



4 pins lead ECG cable

True colour 3.5" TFT display

CE 0123

FDA 510 (K)

Pocket size: 13x9.5x3.2 cm

32 MB memory inside

• 33245 CARDIO-C POCKET ECG 3 channel

- small size, light-weight and easy to carry
 - one-key measurement
 - clear ECG waveform and interpretation of results on colour dot-matrix TFT 3.5" screen
 - up to 19 types of measurement results
 - high capacity built-in memory: 24 hours records storage and review for single channel waveform and 8 hours record storage and review for 3-channel waveforms
 - quick measurement: **by built-in metal electrodes**, on palm, chest or leg or **by external lead wires** (needs optional limb and chest electrodes)
 - data management to review or delete data records locally or to upload to PC
- Supplied with ECG viewer software, USB cable, power transformer, ECG 4 pins lead wire, 25 disposable electrodes, manual (GB, FR, IT, ES, DE, PT).

- 33364 SET OF 4 LIMB CLAMP ELECTRODES (4 COLOURS) - adult
- 33327 DISPOSABLE TNT ELECTRODES Ø 55 mm

TECHNICAL SPECIFICATIONS	
Heart rate measuring range:	30 bpm ~ 240 bpm
Heart rate measuring accuracy:	± 2 bpm or ±2% whichever is greater
ECG bandwidth:	0.5 Hz ~ 40 Hz
Internal noise level:	≤ 30µVp-p
Display scale:	5.0 mm/mV ±10%
Common-mode rejection ratio (CMRR):	≥ 60 dB
Waveform sweeping speed:	20 mm/s ±10%
Input loop current:	≤ 0.1 µA
Input impedance:	≥ 5 MΩ
Power	
Power:	4 AA alkaline batteries
Supply voltage range:	4.4 ~ 6 VDC
Max average working current:	≤ 160 mA
Auto power-off:	can be adjustable between 1-5 mins
Low battery indication:	4.4 VDC ±0.2 VDC

Methods of ECG measurements: direct or with lead wires



Internal software in GB, IT, FR

CARDIPOCKET ECG - 3 CHANNELS

• 33232 CARDIPOCKET ECG 3 CHANNELS - with software

12-lead ECG printing ECG waveform with thermal printing system, measuring and diagnosing ECG waveform parameters automatically.

- full-automatic analysis function: auto-analysis and auto diagnosis for routine ECG parameters. It provides measurement results and auto diagnosis conclusion for HR, P-R interval, P Duration, QRS Duration, Q-T interval, Q-tc, P Axis, QRS Axis, T Axis, R(V5), S(V1), R(V5)+ S(V1)
- 2.83" colour LCD screen (resolution 320x240) that operates both with touch screen and keys
- high resolution thermal array output system 8 dots/mm (vertical)
- built-in rechargeable lithium detachable battery can continuously work for 4 hours, print up to 90 minutes and 150 ECG
- store up to 100 cases in a SD card (not included)
- high-accurate digital filter eliminates baseline drift and distortion to ECG waveform
- ECG-Sync software to form a ECG workstation
- 32963 THERMAL PAPER - box of 20 rolls
- 33233 RECHARGEABLE Li-Ion BATTERY
- 33328 ECG CABLE spare

TECHNICAL SPECIFICATIONS

Power:	AC: 100-240 V, 50/60 Hz - DC 12V rechargeable lithium battery 2,000 mAh	
Noise level:	≤15 µVp-p	CMRR: >60 dB, > 100 dB (add filter)
EMG filter:	25/35 Hz	Time constant: ≥3.2 s
Frequency response:	0.05-150 Hz (-3 dB - 0.4 dB)	
Patient leakage current:	<10 µA	
Recording paper:	50 mm x 20 m, high speed thermal paper	
Paper speed:	6.25, 12.5, 25, 50 mm/s ±5%	
Safety standard:	IEC class I, type CF defibrillation-proof applied part	
Input mode:	floating and defibrillation protection	
Input circuit current:	≤0.1 µA	Input impedance: ≥50 M Ω

Size: 207x96x62 mm
Net weight: 500 g

STANDARD ACCESSORIES

- Patient cable
- 1 roll of paper
- 1 rechargeable lithium battery
- 4 limb electrodes
- 6 chest limb electrodes
- 1 user manual (GB, IT, FR)
- 1 CD software (GB, FR, IT, ES, DE, TR) and cable for connection to PC



CARDIPOCKET ECG - 1 CHANNEL

• 33257 CARDIPOCKET ECG - standard 12 lead ECG - with software

Compact and lightweight pocket device with unbeatable features:

- wide graphic display (it allows "live" view of ECG trace and selection of all parameters)
- rechargeable lithium battery operated (80 ECG with full charge)
- PC software with interpretation included for storing data into PC (GB/IT) (operating system: Microsoft Windows 2000/XP/2003/Vista/7)
- multilanguage internal software: GB, IT, DE, FR, ES, TR, CN
- real time continuous records of clear and exact single channel ECG waveform and notes. The notes include mark, sensitivity, chart speed, filter mode, etc
- full-touch keyboard control, easy to use. Screen displays, working position, state of the instrument are clear and easy to be read.

- 32963 THERMAL PAPER - box of 20 rolls
- 33243 RECHARGEABLE Li-Ion BATTERY up to S.N. CD 1212100050
- 33244 RECHARGEABLE Li-Ion BATTERY since S.N. CD 130730000-1
- 33328 ECG CABLE - spare

TECHNICAL SPECIFICATIONS

Power:	AC: 100-240V, 50/60 Hz - DC: 7.4V / 2,000 mAh	
	DC: 9V rechargeable battery	
In optimal DC state up to 8 h standby time, up to 4 h continuous print		
Noise level:	≤15µVp-p	CMRR: >60 dB, >100 dB (add filter)
EMG filter:	35 Hz (-3 dB)	Time constant: ≥3.2s
Sensitivity display:	standard sensitivity: 10mm/mV±2%	
Sensitivity setting:	1/2, 1, 2 (cm/mV), conversion deviation ≤5%	
Recording system:	thermal-array, 8 dots/mm (vertical), 16 dots/mm (horizontal, 50 mm/sec), 32 dots/mm (horizontal, 25 mm/sec)	
Paper speed:	25 mm/s, 50 mm/s ±5%	
Recording paper:	50 mm x 20 m, high-speed roll	
Safety standard:	IEC class I, type CF	
Input circuit current:	≤50nA	

Integrated thermal printer



Weight 800 g with rechargeable battery

Compact: only 190 mm (size: 190x90x40 mm)

60x35 mm wide display

STANDARD ACCESSORIES

- Patient cable
- 1 roll of paper
- 1 rechargeable lithium battery
- 4 limb electrodes
- 6 chest limb electrodes
- 1 user manual (GB, IT, FR)
- 1 CD software and cable for connection to PC



PM10 PALM ECG WITH SOFTWARE AND BLUETOOTH

• 33246 PM10 PALM ECG - with software and Bluetooth

PM10 is a homecare device to check ECG parameters. It can be used as a reference for patient to take further medical treatment and reference for doctor to diagnose. It can help to early prevent from cardiovascular diseases and reduce risks. Intelligent design, it achieves remote health management through mobile application; it can automatically start measurement, store ECG, upload data, download health results. Suitable for patients with chronic diseases, especially coronary heart disease, diabetes, hypertension, myocarditis, obesity, chest pain, palpitations and dyspnea.

4 MEASUREMENT MODES



Features:

- 1.77" colour TFT-LCD
- quick ECG test with a simple touch. User friendly
- accurate conclusion can be obtained immediately after measuring
- continuously record for up to 500 cases with built-in rechargeable lithium battery in full charge
- Bluetooth transmission
- ECG data can be saved to cloud Platform permanently, easy to check and analyze
- historical data can be printed at any time, easy to diagnose

Size: 100x45x15 mm
Weight: about 60g

Supplied with a carrying bag, a multilanguage manual (GB, FR, IT, ES, DE, PT) and a CD software to visualize data on PC



33246

DIGITAL SINGLE, 3 OR 3/6 CHANNEL ECG

- **33220 SINGLE CHANNEL ECG 100G**
 - large LCD display waveform and data
 - high-resolution thermal printing array system
 - frequency response is as high as 150 Hz
 - capable of printing continuously on channel trace and annotations including lead mark and parameter such as sensitivity, paper speed and filter operation status
 - high resolution digital filter inhibits baseline drift without affecting ECG waveform
 - floating input circuit meets IEC safety standard
 - rechargeable battery supporting more than 50 patient examinations
 - internal software: GB, IT, DE, TR, RU, CN
 - manual: GB, IT, ES
- **33225 RECHARGEABLE BATTERY - spare**
- **32968 PAPER ROLL 50 mm x 20 m - box of 20**
- **33328 ECG CABLE - 10 leads - spare**



CONTEC™

33220

USB connection allows real-time transmission to PC, remote data analysis and diagnosis, management and printing through the PC



33221

- **33222 6 CHANNEL ECG 600G - monitor up to 12 channels**
 - 7" TFT, colour LCD touch screen
 - 12 leads simultaneous display
 - digital isolation technology and signal processing solution, digital filter
 - patient management, name, age and id, detail analysis report
 - built-in lithium rechargeable battery
 - thermal printing system provides more than 10 printing modes
 - can print 90 minutes and print out 150 ECG continually
 - ECG-Sync software, USB connection to PC and built-in memory can store more than 1000 cases
 - auto-measurement, auto-analysis and auto-interpretation
 - internal software: GB, FR, IT, ES, DE, TR, PL, PT, SI, RU, KZ, CN
 - PC software: GB. Manual: GB, IT, FR
- **33226 RECHARGEABLE BATTERY - spare**
- **32970 PAPER ROLL 110 mm x 20 m - box of 10**
- **33328 ECG CABLE - 10 leads - spare**



- **33221 3 CHANNEL ECG 300G - monitor up to 12 channels**
 - 3.5" TFT colour LCD screen
 - 12 leads simultaneous display
 - thermal printing system
 - AC and DC power supply
 - high capacity built-in lithium rechargeable battery
 - battery power supports up to 150 ECG continuous records
 - built-in Database
 - built-in memory can store more than 1000 cases
 - digital signal processor for filter
 - auto-measurement, auto-analysis, auto-interpretations
 - ECG-Sync software, USB connection to PC
 - internal software: GB, FR, IT, ES, DE, TR, PL, PT, SI, YU, RU, KZ, CN
 - PC software: GB
 - manual: GB, IT, ES, FR
- **33226 RECHARGEABLE BATTERY - spare**
- **32969 PAPER ROLL 80 mm x 20 m - box of 10**
- **33328 ECG CABLE - 10 leads - spare**

USB connection allows real-time transmission to PC, remote data analysis and diagnosis, management and printing through the PC



33222

TECHNICAL SPECIFICATIONS

		ECG 100G	ECG 300G	ECG 600G	
ECG instrument Input	Safety Type	Class I, type CF applied part, which has defibrillation-proof applied part			
	Lead	Standard 12 leads			
	Input way	Floating and defibrillation protection			
	Patient leak current	<10µA			
	Sampling rate	800 Hz	1,000 Hz	1,000 Hz	
	A/D conversion	12bit			
	Frequency response	0.05Hz~150Hz (-3dB, + 0.4dB)			
	Time constant	≥ 3.2s			
	CMRR	>60dB, >100dB(Add filter)			
	Enduring polarization voltage	±500mV			
Dispose Wave Data	Noise level	<15µVp-p			
	EMG interference filter	35Hz (-3dB)	25Hz/35Hz (-3dB)		
	AC filter	50Hz/60Hz (-20dB)			
	Recording way	Thermal printing system	Thermal printing system (32spots/mm)		
Waveform output	Recording paper	50mm(W)×20m(L)	80mm(W)×20m(L)	110mm(W)×20m(L)	
	Sensitivity	5, 10, 20mm/mV	2.5, 5, 10, 20, 40 mm/mV		
	Paper speed	Auto-record: auto leads changing	Auto-record: 25mm/s, 50mm/s		
		Rhythm record: 25 mm/s, 50 mm/s	Manual-record: 25 mm/s, 50 mm/s		
			Manual-record: 5, 6.25, 10, 12.5, 25, 50 (only 33221), 100 mm/s (only 33222)		
Power supply Fuse	AC	110-220V, 50/60 Hz			
	DC - Lithium battery	7.4V, 2000 mAh	7.4V, 3500 mAh		
Form	Size	2 pcs ø5x20mm AC time lag; T250mA/250V(Power Supply:220V)			
	Net Weight	1.5 kg	1.6 kg	1.7 kg	



STANDARD ACCESSORIES

- ECG cable - 1 set
- Limb electrode clamp - 1 set
- chest electrodes - 1 set
- Ground wire
- Power connection
- Paper roll
- USB connection and PC software (only 33221 and 33222)

- **33228 CARRYING BAG 39x29x14 cm**



3 AND 6-12 CHANNEL DIGITAL ECG WITH HIGH RESOLUTION MONITOR

33334

33350



Portable with small dimensions and light weight

Large, high resolution backlight Display: LCD 320x240 dots.

- 33334 CARDIOGIMA 3M - 1-3 ch. with interpretation
- 33350 CARDIOGIMA 6M - 3-6-12 ch. with interpretation (monitor 3-6 channels, printer 3-6-12 channels)
- LCD monitor in Standard or Cabrera format with base line setting
- High resolution thermal printer (8 dots/mm): hardcopy 1-3 or 3-6-12 channels real time with possibility to print a millimetric grid
- Manual or automatic recording
- Image freeze with memory scrolling for reviewing and hard copy of acquired signals (Memory 10 seconds for each lead)
- Digital filters for elimination of muscle tremors, power line and base line noises
- Pacemaker detection
- Power supply by built-in high capacity Ni-Cd batteries and fast charging time

- Very simple operation by pre-defined fast keys and menus
 - Based on a risk processor for a full digital signal processing
- Made in Italy.

STANDARD ACCESSORIES 3M AND 6M

Patient cable	6 chest limb electrodes
4 limb electrodes	1 roll of paper
Manual (English, Italian)	1 bottle of gel
Rapid guide: English, Spanish, Italian	Battery

code	CARDIOGIMA ACCESSORIES	Minimum order
27139	Transport bag (see at page 60)	-
32996	Thermal paper 58 mm x 25 m (Cardiogima 3M)	box of 20
32953	Thermal paper 112mm x 23m (Cardiogima 6M)	box of 10
33328	ECG cable 10 leads - spare	-

TECHNICAL SPECIFICATIONS CARDIOGIMA 3M AND 6M

Power supply: internal rechargeable Ni-Cd batteries
 AC/DC Adapter: 100-240V, 50-60 Hz; 200mA
 Battery autonomy: 2.5 hours
 Applied part: CF type
 Input impedance: > 100 Mohm
 Frequency response: 0.05: 145 Hz
 Cmr: > 91 dB (33334), Cmr: > 100 dB (33350) Time constant: > 3.2 s
 Acquisition: 12 bit 800 samples/sec/channel-isochrome
 Leads: 12 standard or Cabrera

Sensitivity: 5mm/mV; 10mm/mV; 20mm/mV ±5%
 Scrolling speed: 5mm/s; 10mm/s; 25mm/s; 50mm/s
 Signal memory: 10s for each lead
 Printer: thermal printer 8 dots/mm, paper 58 mm (3M) 110 mm (6M).
 Filters: muscles tremors 35Hz digital; power line interferences 50-60Hz digital; high pass 0.5Hz digital
 Defibrillation protection: internal
 Display/Hardcopy: 1/3 channel (3M) 3/6/12 channel (6M)
 Dimensions: 240x160x65 mm. Weight: 1.5 kg. Made in Italy

CARDIOGIMA 1M - 1/3 CHANNEL ECG WITH PARAMETERS CALCULATION

CE 0068



33329

- 33329 CARDIOGIMA 1M - 1-3 channel ECG with monitor
- A real portable ECG with small dimension and light weight (1 kg), with LCD monitor 128x64 pixel, high resolution thermal printer (8 dots/mm hardcopy, 1 channel real time) and parameters calculation. With manual or automatic recording, memory 10 seconds for each lead. Includes digital filters for elimination of muscles tremors, power line and base line noises. Based on a risk processor for a fully digital signal processing. Made in Italy.
- 32996 THERMAL PAPER 58 mm x 25 m - box of 20
 - 33328 ECG CABLE 10 leads - spare

STANDARD ACCESSORIES

Patient cable	1 roll of paper
1 bottle of gel	4 limb electrodes
Manual (English, Italian)	6 chest limb electrodes
Rapid guide: English, French, Spanish, Italian	Battery

TECHNICAL SPECIFICATIONS

Power supply: internal rechargeable Ni-Mh batteries
 AC/DC Adapter: 100-240V, 50-60 Hz; 200mA
 Battery autonomy: 3 hours
 Applied part: CF type
 Input impedance: > 100 Mohm
 Frequency response: 0.05: 145 Hz
 Cmr: > 100 dB time constant: > 3.2 s

Acquisition: 12 bit 800 samples/sec/channel
 Leads: 12 standard or Cabrera
 Sensitivity: 5mm/mV; 10mm/mV; 20mm/mV ±5%
 Scrolling speed: 5mm/s; 10mm/s; 25mm/s; 50mm/s
 Signal memory: 10 sec for each lead
 Printer: thermal printer 8 dots/mm, paper 58 mm.
 Defibrillation protection: internal

Filters: muscles tremors 35Hz digital; power line interferences 50-60Hz digital; high pass 0.5Hz digital
 Dimensions: 190x120x60 mm. Weight: 1 kg.
 Conformity standards: 93/42/CEE; EN60601-1; EN60601-1-2; IEC601-2-25 Made in Italy

EDAN SINGLE OR THREE CHANNEL ECG

33330



33333

Single and three channel with 12 channel display



INTERPRETATION

COLOUR DISPLAY

EDAN PORTABLE ECG - 1 and 3 channel

- foldable LCD screen, vivid waveform display
- built-in high resolution thermal printer
- built-in rechargeable Li-ion battery, AC/DC supply
- complete digital filter, avoid baseline drift, AC, EMG interfere
- automatic baseline adjustment
- auto/manual operation selectable
- lead-off detection and alarm

SE-3 Three channel colour ECG also features

- interpretation tested by CSE/AHA/MIT database
 - 12 Lead simultaneous acquisition
 - automatic ECG parameters measurement and analysis
 - auto, manual, rhythm off work mode
 - support barcode scanner to simplify patient information input
 - LAN/RS232/USB connection to PC
 - 12 leads grid printing on normal A4 paper by external printer
- ECG Viewer Software: PC based ECG data management software**
- compatible with Windows XP, WIN 7, Vista (32 bit, 64 bit)
 - multi format reports - XML/SCP/DICOM/PDF/JPG/BMP/TIFF/PNG
 - support bi-directional communication with ECG device

TECHNICAL SPECIFICATIONS

	33330	33333
Lead:	One lead	Standard 12 leads
Acquisition mode:	One lead	12 leads simultaneously
Sensitivity:	2.5, 5, 10, 20 mm/mV	> 50 MΩ (10 Hz)
Input impedance:	EMG Filter 35 Hz (-3 dB)	EMG Filter 25/35/45 Hz off
Filter:	AC/DFT Filter 50 Hz/60Hz (-20 dB)	DFT Filter 0.05/0.15/0.25/0.32/0.5/0.67 Hz Low pass filter 150/100/75 Hz AC Filter on/off
Recording mode:	Auto/Manual	Auto/Manual/Rhythm/USBPRT
Rhythm lead:	Any lead selectable	IEC ICF
Safety standard:	AC: 100-115 V, 220-240 V, 50/60 Hz	Rechargeable Li-ion battery: voltage 14.8 V
Power supply:	More than 6.5 hours continuous operation with battery supply	500 ECG's
Data storage:	50 mm x 30 m	rolled 80 mm x 20 m folded 80x70 mm x 200 pages
Thermal paper:	25 mm/s, 50 mm/s (± 3%)	5mm/s, 6.25 mms 10 mm/s, 12.5 mm/s, 25 mm/s, 50 mm/s (±3%)
Paper speed:	300x260x75 mm	2.3 kg (with battery)
Dimension:	192x64 pixel LCD	320x240 pixels LCD (colour screen)
Weight:	GB, IT, FR, ES, PL, RU, TR, UA	GB, IT, FR, ES, RU, PL, CZ, RO, DE, TR, HR, UA
Display:	PL, RU, TR, UA	Ethernet, RS232, USB
Selectable display language:	RS 232	yes
Interface:	-	PDF, Dicom, SCP, XML
Barcode scanner support:	-	
Report formats:	-	

code	EDAN ECG AND ACCESSORIES
33330	Edan SE-1 Single Channel ECG
33333	Edan SE-3 colour Three Channel ECG - interpretative
33336	ECG-Viewer Software (GB, FR, IT, DE, PL, RU, ES, TU) for 33333
32963	Thermal paper - roll 50mm x 25m for 33330 and 33305
32964	Thermal paper - roll 80mm x 25m for 33332/3 and 33306
33328	ECG cable - spare
33318	Rechargeable Lithium battery 2500 mAh - spare
27139	Transport bag - see page 60

STANDARD ACCESSORIES

Patient cable	1 roll of paper	4 limb electrodes
1 bottle of gel	Rechargeable battery	6 chest limb electrodes
Manual: GB, IT. On request: FR, ES, PT, TR (SE-1 and SE-3), DE, RU (SE-3 only)		

MINDRAY BENEHEART R3 ELECTROCARDIOGRAPH

• 33301 MINDRAY BENEHEART R3 ELECTROCARDIOGRAPH 3 channels

Lightweight portable cardiograph for resting ECG diagnosis.

Reliable analysis - Glasgow algorithm

Utilizes the University of Glasgow ECG analysis algorithm, one of the world-leading resting ECG interpretations.

Great Portability - only 1.2 kg

Weighs only 1.2 kg with battery, easy to carry.

5" clear colour display

Offers the highest resolution in industry, enabling clinicians to observe real-time waveforms accurately.

Convenient operations

ECG recording is automatically unfolded on the writing pad at the top of the unit for notes or signature.

Unique recorder - Z-folded or rolling paper

Compatible with both rolling paper and Z-fold paper.

Easily switchable without dismantling the pressure lever.

• 33014 ROLL THERMAL PAPER - 80 mm x 20 m - box of 10

• 33016 Z-FOLD THERMAL PAPER - 80x70 mm x 200 sheet - box of 25



The Glasgow algorithm is the first to be based on specific variables, including age, gender, race, medication, and class in order to maximize the accuracy of the ECG interpretation. On the report, a headline may highlight one or several "critical value warnings" to alert medical attendants of findings that need immediate attention.



STANDARD ACCESSORIES

Cable with banana plugs, IEC	1 roll paper
Limb clamp set of 4	Rechargeable battery
Chest bulb set of 6	User manual in: GB, FR, DE, HU, IT, PL, ES, TR
Glasgow algorithm (available in 13 languages as internal software)	

Power	AC power: 100 to 240 VAC ± 10% 60 VA
Battery-type:	rechargeable Lithium ion battery 11.1 V typical, 2,500 mAh
- capacity:	6 hours of continuous operation without recording or 500 ECGs in 2.5 x 4 format at 25 mm/s and 10 mm/mV
- charge time:	3.5 hours with power off
Processing	ECG analysis 500 samples/second (sps)
Digital	1,000 samples/second/channel
Pacer detection	16,000 samples/second/channel
Acquisition mode:	Pre-acquisition or post-acquisition provide 10 seconds of instantaneous ECG acquisition

TECHNICAL SPECIFICATIONS	
ECG amplifier:	DC-coupled
Input impedance:	50 MD at 10 Hz, defib protected
Patient leakage:	< 10 µA
Heart rate meter:	30 to 300 BPM ± 10% or ± 5 BPM, whichever is greater
Sensitivity/gain:	5, 10, 20 mm/mV, Auto
Colour display	TFT LCD with LED graphics backlit 800x400
Resolution:	Patient ID, gender, age, heart rate, clock, battery power indicator, waveforms, lead labels, speed, gain, filter settings, warning messages, information messages, network status and USB
Display data:	

Thermal printer:	Dot array/Width 80 mm/speed 5, 12.5, 25, 50 mm/s
Software	Resting ECG mode: Records and prints 12-lead resting ECG with 10-second duration
Patient information:	Patient ID, secondary ID, age, date of birth, gender, race, medication class and V3 electrode placement
Internal storage:	800 ECGs in internal memory
ECG Storage format:	PDF and Mindray storage format GB, FR, IT, ES, DE, PL, PT, TR, RU, HU, RO, CZ, CN
internal software:	Thermal printer/PDF/A4/letter 250x194xh 56 mm/1.2 kg including battery
Report formats	
Size/Weight:	

MULTI CHANNEL ECG WITH INTERPRETATION ON PAPER



33354

SOFTWARE INCLUDED FOR DATA STORAGE ON PC

- **33354 CARDIOGIMA 12 ECG - 3-6-12 channel**
Cost effective 12 channel resting ECG recorder without performance compromise. The simultaneous record of 12 channels has a high diagnostic value - all the 12 channels are shown at the same time. A4 size paper, one body type.
- Main Features:**
 - 12 leads simultaneous 10-second resting ECG with interpretation in only 60 seconds multilanguage.
 - Internal software+print in GB, FR, IT, DE, RU, TR, CN.
 - wide paper printing (A4 size thermal paper, fax paper is OK)
 - combined output of all relevant curves, patient data, date, time and instrument settings
 - **PC Connections**
Connection to PC with RS 232 port or LAN to submit recorded ECG signal to other specialist for evaluation (only a modem is needed)
 - **ECG filing system**
A fully configured PC-based software enables to record, print, change the settings of ECG's and save them in JPG format, which ensure compatibility with most EMR package.
 - **rechargeable batteries (optional)** with 1 hour capacity in normal use (about 100 ECG printouts)

TECHNICAL SPECIFICATIONS

ECG Leads: 3-6-12 channel illustration of ECG signals in continuous recording or 10 sec. recording with interpretation.

Dimension: 296x305.5x92.5 mm Approx 3 kg

Recording channel: 3, 6, 12 channel and 1 channel (60 sec.)

Sensitivity: 2.5, 5, 10, 20, auto (I-aVF: 10, W1-V6: 5) mm/mV

Printing speed: 12,5; 25; 50 mm/s

Filters: AC (50/60 Hz, -20 dB or better), Muscle (25-35 Hz, -3 dB or better) Low pass filter (off, 40 Hz, 100 Hz, 150 Hz)

Display: 2x16 character LCD display

LCD display: Sensitivity, speed filter status, HR, Printing form, rhythm lead

LED indicator: Signal quality, power source, battery

Keyboard: Membrane keyboard, alphanumeric and symbol available

Patient data: ID, name, age, sex, height, weight

Basic measurement: Heart rate, PR, QRS, QT/QTc, P-R-T axis

Recorder: Thermal print head, thermal paper roll
Report papers: A4: 215x297 mm (8.5"x11.7")
Letter: 215x280 mm (8.5"x11")

Resolution: vertical: 8 dots/mm, horizontal: 16 dots/mm

Electrical: Internal noise: 20 µV (p-p) max
Input circuit: floating input
Isolated and defibrillation protected
DC offset voltage: $\geq \pm 300$ mV
Patient leakage current: $< 10\mu\text{A}$
Frequency response 0,05-150 Hz
Power supply: AC or built-in battery (options)
Power requirement: 100-240 Vac, 50/60 Hz, 1.0-0.5 A
Power consumption: 60 W max

Battery capacity: 1 hour of normal use (approx. 100 automatic ECG printouts)

Communication: PC Connection with RS-232 interface and lan

Safety: Class I, Type BF

Conformity: CE, FDA, KFDA, CFDA, NCC Made in Korea

STANDARD ACCESSORIES

- 1 PC software (GB/IT)
- 1 ECG gel tube (250 ml)
- 1 LAN cable
- 1 Recording paper roll
- 1 Patient cable - 10 leads
- 1 Operation manual (GB/IT)
- 4 ECG clip-on electrodes
- 6 Chest electrodes, suction for adult
- 1 Power cable



code	CARDIOGIMA 12 ACCESSORIES	
29534	Rechargeable battery - for 33354/33355/33357	33354 + 29519
32950	Thermal paper A4 - for 33354-5-7 - box of 5	
33328	ECG cable for 33354-5-7	
29519	Trolley for 33354-5-7	

DIGITAL 12 CHANNEL COLOUR ECG WITH WI-FI



33223

- **33223 12 CHANNEL ECG 1200G with WI-FI**
- 8" TFT display, 800x600 dots high resolution colour LED backlight
- simultaneous 12 leads acquisition and display
- digital signal technique, AC filter, baseline filter, EMG filter
- auto-analysis and auto-interpretation
- Multi-mode display and printing, such as 12, 6+1 (rhythm), 6, rhythm 12, rhythm 10, rhythm 8, rhythm 6. Manual, Freeze etc
- 0.5 built-in lithium rechargeable battery
- 2 USB and LAN Socket for uploading data to PC
- built-in flash memory. Stores more than 1,000 files
- Multi-language internal software: GB, FR, IT, ES, PT, PL, SI, TR, RU, KZ, CN.
- **33227 RECHARGEABLE BATTERY - spare**
- **32967 PAPER ROLL 210 mm x 30 m**
- **33328 ECG CABLE - 10 leads - spare**



TECHNICAL SPECIFICATIONS

Input way Floating and defibrillation protection

Lead Standard 12 leads

Patient leak current $< 10\mu\text{A}$

Input impedance $\geq 50\text{M}\Omega$

Frequency response 0.05 - 150 Hz (-3 - + 0,4 dB)

Time constant ≥ 3.2 s

CMRR > 60 dB, > 100 dB (adding filter)

EMG interference filter 25/35 Hz (-3 dB)

Thermal paper 210 mm x 30 m high-speed

Paper speed Auto and rhythm record: 25, 50 mm/s, $\pm 5\%$
Manual record: 5, 6.25, 10, 12.5, 25, 50 mm/s, $\pm 5\%$
2.5, 5, 10, 20, 40 mm/mV, $\pm 5\%$.

Sensitivity selections Standard sensitivity is 10 mm/mV ± 0.2 mm/mV.

Auto record Record setup according to auto record format and mode, automatically changing leads, measuring and analyzing.

Rhythm record Record setup according to rhythm record format and mode, automatically measuring and analyzing.

Manual record Record setup according to manual record format, manually changing leads.

Measurement parameters HR, P-R interval, P Duration, QRS Duration, T Duration, Q-T interval, Q-Tc, P Axis, QRS Axis, T Axis, R(V5), S(V1), R(V5)+S(V1)

Product safety type Class I CF defibrillation and pacing protection

Size 334x320x85 mm

Power AC: 100-240 V, 50/60 Hz
DC: 14.8 V, 3700mAh rechargeable lithium battery

STANDARD ACCESSORIES

- 1 ECG cable
- 1 ground wire
- 1 set limb electrode clamp
- 1 paper roll
- 1 set chest electrodes
- Power connection
- USB connection
- Rechargeable battery
- Software (same languages as internal software)
- Manual: GB, FR, IT



CARDIO 7: 12 CHANNEL RESTING ECG WITH TOUCH SCREEN

SOFTWARE EKG VIEW PLUS
for data storage on PC



Long term ECG recording and automatic arrhythmia detection

Touch screen operation full alphanumeric keyboard support

Optional spirometry function

USB function



33357

One touch operation for analyzing, storing and printing within 3 seconds

Rotary key access to all menus

Various standard formats: JPG, PDF, XML, MFER, DICOM

- 33357 ECG CARDIO 7: 12 CHANNEL ECG WITH TOUCH SCREEN
- 12 channel interpretive ECG for adult, pediatric and neonatal use
- over 130 kinds of interpretation results based on advanced Minnesota code, HRV (Heart Rate Variability analysis)
- memory for up to 200 patients
- real-time preview monitor
- PC compatible through LAN or Wi-Fi
- multi-language selectable software (GB, RU, FR, DE, IT, CN, ES, TU, PL, RU, PT)
 - lead fault message
 - pace maker detection
 - automatic arrhythmia detection
 - 3, 5, 10 minutes long term recording
 - grid function allows you to use low cost plain fax paper
 - wide and clear colour 7" TFT LCD (800x480)
 - touch screen for easy operation
 - full disclosure function
- 32950 THERMAL PAPER A4 - box of 5 rolls
- 29534 RECHARGEABLE Ni-MH 12 V BATTERY up to S.N. T7xxxxxxx - optional
- 29536 RECHARGEABLE Li-Ion BATTERY since S.N. T8xxxxxxx - optional
- 29519 TROLLEY
- 33328 ECG CABLE

STANDARD ACCESSORIES

Patient cable - 10 leads
LAN cable
1 bottle of ECG cream (70 g)
1 power cable
manual (GB, IT)

1 paper roll
4 limb electrodes
6 chest limb electrodes
EKG View Plus (GB, IT)

TECHNICAL SPECIFICATIONS

ECG leads : 10 lead, 12 channel simultaneous ECG and acquisition
Dimension: 300(W) x 299(H) x 123(D)mm, approx. 3.5 kg
Recording channel: 3 channels + 1 rhythm, 3 channels + 3 rhythm, 6 channels + 1 rhythm, 12 channels, 60 seconds
1 channel, 3, 5, 10 minutes 1 channel and beat report
Sensitivity: 2.5, 5, 10, 20, auto (I-aVF: 10, V1-V6: 5) mm/mV
Printing speed: 5, 12.5, 25, 50, 100 mm/s
Sampling rate: 2,000 samples/sec
Filters: AC (50/60 Hz, -20 dB or better)
Muscle (25-35 Hz, -3dB or better)
Base line drift (0.05, 0.1, 0.2 Hz, -3dB or better)
Low pass filter: off, 40 Hz, 100 Hz, 150 Hz
Display: 7" color TFT LCD display (800x480), 12 channels preview ECG wave
Monitor display: ID, date, sensitivity, speed, filter, form, rhythm lead
User interface: Touch screen (alphanumeric and symbol available), Keyboard, rotary push-knob (pop-up menu)
Patient data: ID, name, age, sex, height, weight, smoke, race
Basic measurement: Heart rate, PR int, QRS dur, QT/QTc, P-R-T axis
Recorder: Thermal print head, roll paper
A4 report paper: 210x300 mm (8.5"x11")

Resolution: Vertical: 8 dot/mm
Horizontal: 16 dot/mm
Electrical: Internal noise: 20 µV (p-p) max
Input circuit: floating input
Input impedance: ≥50 MΩ
Input voltage range: ≥ ±5 mV
Common mode rejection: > 105 dB
DC offset voltage: ≥ ±400 mV
Time constant: 3.2 sec
Patient leakage current: < 10 µA
Frequency response: 0.05 - 150 Hz
Isolated and defibrillation protected
Signal quality control: Disconnected lead detection
Pacemaker pulse detection
ECG data storage: storage for 200 ECGs (Internal on flash memory)
Power: AC 100-240 VAC, 50/60 Hz or battery (option)
2.0-1.0 A, 60 VA max
Battery (Li-Ion): 4 hours of normal use (approx. 200 ECG printouts)
Communication: PC connection with LAN D2 Wi-Fi
Safety conformity: Class I, Type CF, CE, CSA, FDA, KFDA, CFDA, CCC

SPIROMETER MODULE FOR CARDIO 7

• 33356 SPIROMETER MODULE - for code 33357
It transforms CARDIOGIMA 7 in a 2 in 1 system:
ECG-SPIROMETER.
Spirometry measuring values:
FVC: FEV 1.0, FEV 1/FVC, FEV 0.2-1.2L, FIVC, FEV 25-75, FEV 75-85%,
PEF, FEF 200-1200 ml, FEF 25%, FEF 50%, FEF 75%, PIF,
FET 100%, FIVC.

SVC: SVC, ERV, IRV, TV, EC, IC, 33356
MVV: TV, MVV, FB
Pre and post bronchodilator comparison.
Presentation: flow volume loop, flow time plot, measurement values table. Complies with ATS standard.
• 33362 DISPOSABLE MOUTHPIECES - box of 100 pcs.



ECG CABLE COMPATIBLE WITH MOST ECG BRANDS

• 33328 ECG cable - 10 leads
Long lasting, individually tested cable compatible with the following ECG machines:
BIONET: Cardiocare, Cardiotouch
CARDIOLINE: E1, E1R, E3, Delta 300, Delta 360, C3.
CARDIETTE (Elettronica Trentina): Autoruler 12/1, Autoruler 12/3, Excel 103, Excel 106, Astron Comp 1, Astron Comp 3, Astron Comp 6, Start 100 P, Start 100 H, Start 200, Start 200HV, AR600, AR 600 ADV, AR1200, AR1200ADV.
CARDIORAPID CAMINA: K111, K112, K33, K36, K300 M, K300 P, K600 P, K600 D, K130 B, K 130 D.

CONTEC: 100G, 300G, 600G, 1,200G
EDAN: Smart SE-1, SE-3
ESAOTE: P80, P8000
GIMA: CARDIOGIMA 1M, 3M, 6M, 12, 12M
HP: Pagewriter 1513, 154B/C, 1514D, 1515A/B, 1517A.
KONTRON EKG P80
MACQUAIRE CT100, CT200.
M4 MEDICAL: M traces
NIHON - KOHDEN Cardiofax 651, 6581, 8110.
PROGETTI all models: EPG junior, EPG view, EPG6 view, EPG6 view plus
SCHILLER AT/1, AT/2, AT/3, AT/4, AT/5, AT/6, AT/10, CS6, CS12, CS100, CV6, P80.



HOLTER ECG SYSTEM - 24 HOURS MONITORING

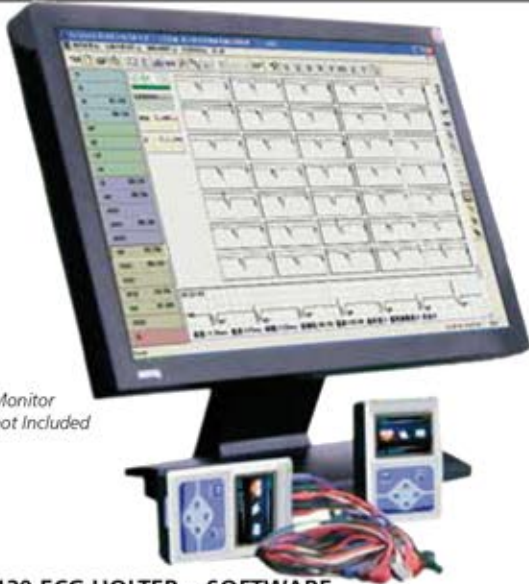

Monitor
not Included

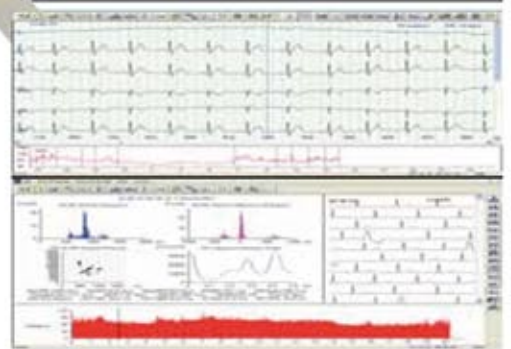

• 35130 ECG HOLTER + SOFTWARE

ECG Holter system includes ECG recorder and software connectable to a computer system or laser printer. The recorder has built-in flash storage media to increase memory capacity. The sampling rate of 1,000 sampling/sec has improved the quality of waveform.

Accuracy of the system is ensured by AHA and MIT data.

Features:

- windows software interface (GB, IT, PL)
 - quick and accurate analyzing system
 - special editing system of R point
 - perfect analysis function of ST segment
 - analysis function of T wave of all channels and T wave trend graph
 - review of ECG trend graph
 - analysis system of HR variability, providing regular SDNN, SDANN, RMSSD, LF, HF, time domain and frequency domain
 - QT analysis and QT trend graph
 - acquire pacing ECG directly without separate channel;
- Also have the functions of VCG, VLP, TVCG, HRT, TWA

Recorder:

- 12 channel Synchronized ECG Acquisition
- small ECG recorder with OLED colour screen to display real time ECG waveform and review storage data.
- capacity up to 2G
- selectable sampling rate, 200, 500, 1,000 sampling/sec
- sampling accuracy: 12 bit
- built-in FLASH storage media, to prevent the flash card from damage due to repeated insertion and pull out
- USB interface
- operating system: Win 98, 2000, XP, 7, 8, 10



• 35131 ECG CABLE - spare

TECHNICAL SPECIFICATIONS

Scale voltage: 1mV±5%	Standard sensitivity: 10mm/mV ±5%	Least measure signal: 50µV p-p
Noise level: ≤30µV	CMRR: ≥60dB	Interference between channels: scan track deflection (result from interference between channels) <0.5mm
Frequency response: 10Hz as benchmark, 0.5Hz-55Hz; -3dB	Time constant: >3.2s	Product safety type: type B (internally powered)
Scan speed: 25mm/s ±5%	Enduring polarization voltage: ±300mV	Size: 111 (L) x60 (W) x25 (H) mm
		Net weight: 105 g (without battery)

STANDARD ACCESSORIES

- 1 Holter recorder
- 1 CD with software
- 10 leads patient cable
- 10 disposable ECG sensor
- 1 pouch for hanging recorder
- 1 USB cable for data downloads
- Instruction Manual (GB, IT)



PC-ECG WITH INTERPRETATION SOFTWARE AND USB PORT

• 33320 PC-ECG + ECG LAB SOFTWARE

Innovative PC-ECG device that can be connected to your PC via USB port. No power cable is required as it is powered through the USB PC cable. The unit is supplied with a 10 banana plug ECG cable (length 295 cm) and a powerful interpretation software (GB, FR, IT, DE, ES, PT, CN).

Main software features:

- 12 lead resting ECG with auto interpretation (ECG)
 - vector ECG (VCG)
 - sampling screen colour customization
 - standard or thermal paper print, B&W or colour
 - auto interpretation On or Off
 - tests comparison
 - multi hour ECG monitoring with holter analysis
 - simple exercise stress test with report
 - e-mail, PDF, ASCII, HL7, Dicom, GDT Interfaces
 - multi ECG report formats
 - measurement table
 - 90s resting ECG full disclosure
- 33328 ECG CABLE - SPARE
- 33321 PC-ECG+CARDIOLOGY SOFTWARE
- Same as code 33320 but with the following specialist functions:
- timed vector ECG (TVCG)
 - SAECG (Signal Averaged ECG) ventricular late potentials analysis
 - QTd analysis
 - hour ECG
 - High Frequency ECG (HFECG)
 - Frequency Cardiogram (FCECG)
 - simple exercise ECG
- 33322 CARDIOLOGY SOFTWARE to upgrade 33320 into 33321



ECG CAD gram to locate coronary artery disease and ischemia



3-VCG analysis



QT Dispersion QTD analysis with chroma map

Above 3 pictures refers to code 33321



CE 0197

PC not included

Only 550 g

4 mm pins

TECHNICAL SPECIFICATIONS

Communication port:	USB - Support HL7, Dicom interface
Size:	120x85x28 mm - 190 g
Power source:	5V DC (from PC USB port)
Patient insulation:	4000 V AC
Defibrillation protection:	built-in patient cable
Sample rate:	10240Hz - Sample accuracy: 16 bit
PC minimum requirements:	Windows 2000, XP Vista and Windows 7 CPU ≥ 1 GHz - HD ≥ 40 G - RAM ≥ 256 M

STANDARD ACCESSORIES

- 4 limb electrodes
- 6 chest electrodes
- Patient cable 10 leads, 10 electrodes
- USB pen driver
- CD software
- Banana plug

FIAB ECG UNIVERSAL ELECTRODES



All with silver chloride sensor and SIS snap

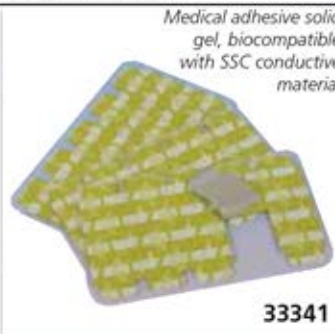

Medical adhesive solid gel, biocompatible with SSC conductive material

33341



1 mm thick

4 mm plug

33372

1 mm thick

33373

4 mm socket

code	FIAB code	Material	Size	Gel	Shape	Connection	Application	Minimum order
33313	F9089P-100	Foam	Ø 32x36 mm	Solid	Oval	Snap	Pediatric - rest, long term, stress and ECG holter	box of 2,000 pcs (20 bags of 100)
33370	F9060P	PE-Foam	Ø 40 mm	Solid	Round	Snap	Pediatric - rest, long term, stress and ECG holter	bag of 50 pcs
33314	F9089-100	Foam	Ø 36x40 mm	Solid	Oval	Snap	Adult - rest, long term, stress and ECG holter	box of 2,000 pcs (20 bags of 100)
33371	F9060	PE-Foam	Ø 48x50 mm	Solid	Oval	Snap	Adult - rest, long term, stress and ECG holter	bag of 50 pcs
33344	F9067	PE-Foam	Ø 48x50 mm	Liquid	Oval	Snap	Adult - rest, stress and ECG holter	box of 1,200 pcs (24 bags of 50)
33327	F2080	Non woven	Ø 55 mm	Solid	Round	Snap	Adult - rest ECG	box of 1,200 pcs (24 bags of 50)
33341	F3001ECG	Gelled	34x23 mm	Solid	TAB	Alligator	Adult - rest ECG	bag of 100 pcs
33372	F9047/4FL	PE-Foam	28x44 mm	Liquid	Rectangular	Plug 4 mm	Adult - rest ECG	box of 1,000 pcs (20 bags of 50)
33373	F9053N	Foam	Ø 23x30 mm	Solid	Oval	35 cm wire with 4 mm socket	Pediatric and neonatal	box of 150 pcs (5 bags of 30)

ADAPTORS FOR ECG ELECTRODES

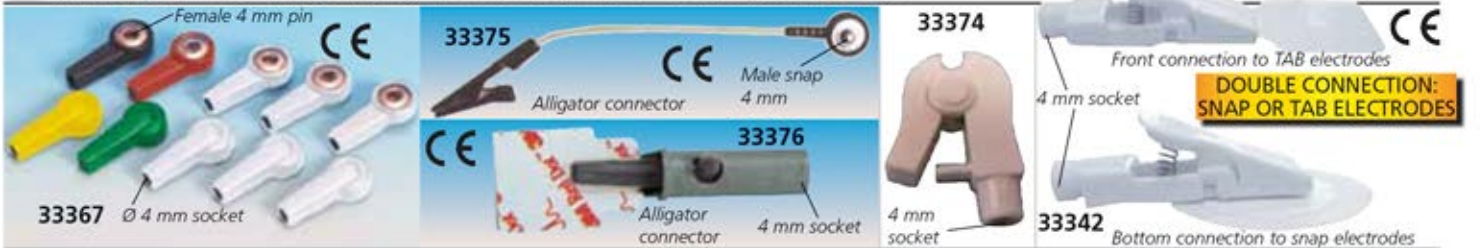

code	UNIVERSAL ADAPTERS FOR ECG ELECTRODES	Minimum order
33367	Set of 10 adaptors (6 white, 1 yellow, 1 green, 1 red, 1 black) for ECG electrodes with 4 mm snap - codes 33313, 33314, 33327, 33344, 33370, 33371	set of 10 pcs
33375	Alligator adaptor with wire - total length: 16,5 cm	10 pcs
33376	Alligator adaptor	10 pcs
33342	Multifunction adaptor - can fit both snap electrodes and TAB electrodes - size 14x54x17 mm	10 pcs
33374	Grabber adaptor - fit snap electrodes - size 22.5x33 mm	10 pcs

LIMB CLAMP AND CHEST ELECTRODES

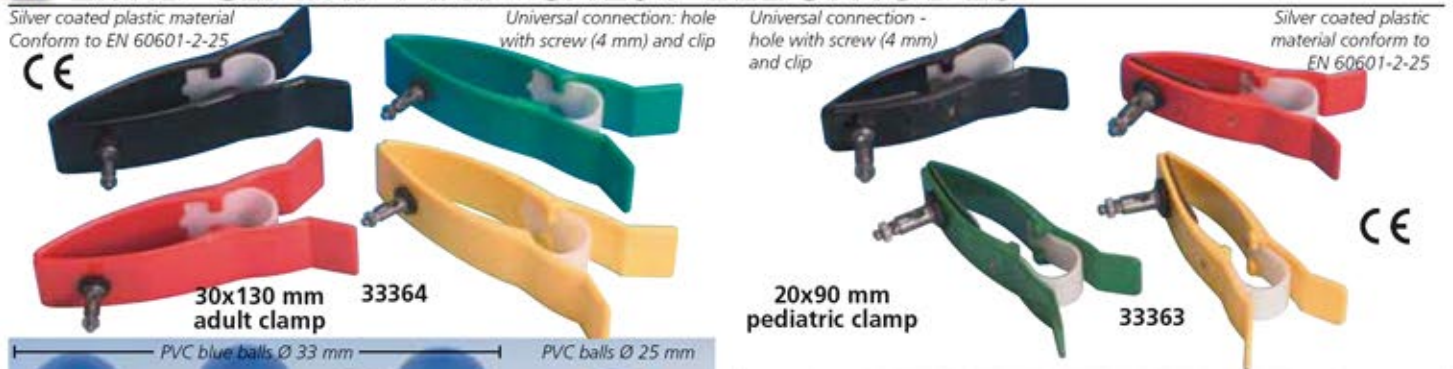

code	UNIVERSAL REUSABLE ECG ELECTRODES LATEX FREE - NICKEL FREE	Minimum order
33363	Set of 4 limb clamp electrodes (4 colours) pediatric	1 set
33364	Set of 4 limb clamp electrodes (4 colours) adult	1 set
33368	Set of 6 chest electrodes Ø 15 mm - silver coated	1 set
33365	Set of 6 chest electrodes Ø 24 mm - silver coated	1 set
33369	Set of 6 chest electrodes Ø 30 mm - silver coated	1 set
33323	Set of 6 chest electr. Ultra Ø 24 mm - silver coated	1 set
33324	Set of 6 chest electr. Ultra Ø 30 mm - silver coated	1 set

3M™ RED DOT™ ELECTRODES



code	3M code	3M™ RED DOT™ ELECTRODES	Minimum order
Gel electrodes - short term diagnostics			
33378	2330	3M™ Red Dot™ - 3.2 x 2.2 cm	bag of 100
Foam monitoring electrodes			
33293	2570	3M™ Red Dot™ - 4 x 3.5 cm	bag of 50
33294	2237	3M™ Red Dot™ - Ø 6 cm	bag of 50
Non woven monitoring electrodes			
33299	2248-50	3M™ Red Dot™ - Pediatric - Ø 4.5 cm	box of 50
33300	2271	3M™ Red Dot™ - 5.6 x 5.1 cm	box of 50
33297	2239	3M™ Red Dot™ - Ø 6 cm	box of 1,000*

*20 bags of 50 pieces

3M 2330 resting ECG electrode with adhesive gel

3M 2570 electrode with foam tape and sticky gel - radiolucent. 5-days wearing time

3M 2237 fluid resistant foam polyethylene backing. 3-days wearing time

33300



3M 2271 diaphoretic soft cloth monitoring electrode with blue abrador 3-days wearing time

33299



3M 2248-50 pediatric monitoring electrode with micropore tape backing

33297



3M 2239 monitoring electrode with micropore tape backing 3-days wearing time

AMBU BLUE SENSOR ECG ELECTRODES



4 mm	Tab or snap	code	AMBU code	Description	Application	Gel type	Backing material	Size (mm)	Shape	Shelf life* (month)	Radiolucent	Connector type	Minimum order	Packaging
		33200 33201	SU-00-A/60 SU-00-C/100	Blue sensor SU	Resting	Wet	Polymer	49x33	Tear drop	24	No	4 mm TAB	box of 1,200 box of 1,200	20 pouches of 60 12 pouches of 100
		33203	L-00-S/25	Blue sensor L	Long-term	Wet	Microporous	68.2x55	Round w/offset	24	No	Snap	box of 500	20 pouches of 25
		33204 33205 33206	VL-00-S/25 VL-00-S/25 VL-00-A/25	Blue sensor VL	Long-term	Wet	Microporous	72x68	Round w/offset	24	No	Snap Snap 4mm	box of 25 box of 500 box of 500	1 pouch of 25 20 pouches of 25 20 pouches of 25
		33208 33209	R-00-A/25 R-00-S/25	Blue sensor R	Stress test	Wet	Foam	57x48	Round w/offset	24	No	4mm Snap	box of 500 box of 500	20 pouches of 25 20 pouches of 25
		33211 33212	M-00-A/50 M-00-S/50	Blue sensor M	Short-term	Wet	Polymer	40.8x34	Round w/offset	15	No	4mm Snap	box of 1,000 box of 1,000	20 pouches of 50 20 pouches of 50

*Shelf life means maximum life from production date. Average Gima shelf life is 50 to 90% of maximum life

BLUE SENSOR

BlueSensor is the world's most time and cost efficient range of electrodes that delivers unmatched readings, user convenience and patient comfort.

BlueSensor ensures that you don't get your workflow disrupted by false alarms or have to waste time resolving problems with electrode adhesion.

Exact monitoring - clear picture

Blue Sensor electrodes give a fast and reliable trace without the need for skin preparation, maximizing comfort for the patient. We know that fast, exact monitoring that ensures a clear picture of the patients' heartbeat is essential to accurate diagnoses.

AMBU BLUE SENSOR SU

- highly conductive wet gel
- superior quick adhesion
- unique offset connector - fitting or tab

- occlusive backing material
- high quality Ag/AgCl sensor
- AMBU BLUE SENSOR L**
- highly conductive wet gel
- combination of instant and long-term adhesives
- breathable microporous material
- unique offset connector
- high quality Ag/AgCl sensor
- AMBU BLUE SENSOR VL**
- highly conductive wet gel
- combination of instant and long-term adhesives
- breathable microporous material
- unique offset connector
- high quality Ag/AgCl sensor
- AMBU BLUE SENSOR R**
- highly conductive wet gel
- superior adhesion
- comfortable foam backing
- large measuring area



- unique offset connector
- high quality Ag/AgCl sensor
- AMBU BLUE SENSOR M**
- highly conductive wet gel
- superior adhesion
- occlusive backing material
- unique offset connector
- high quality Ag/AgCl sensor

ECG GEL AND SPRAY

- 33266 ECG GEL - 250 ml - box of 40 tubes
- 33263 ECG GEL - 5 l - box of 4 bags**
- 33268 ECG SPRAY GEL - 250 ml - box of 20 tubes

Suitable for non pre-gelled electrodes, ECG latches and pendant switches in any ECG and exertional applications. Allows ECG waves clear transfer to equipment.

It is hypoallergenic, does not irritate skin, does not contain oil and oily substances, does not contain formaldehyde and salt, has no toxic effects and is odourless.

- 33283 PUMP FOR BAG 5 l

**Includes 4 empty bottles 250 ml and 1 nozzle for easy refill



GIMA ECG THERMAL PAPERS FOR DIFFERENT ECG BRANDS



code	ECG MANUFACTURER AND MODEL	Type	Width mm	Length m	Sheet	Marker	Grid*	Min. order
32951	ASPEL Ascard A4, B56, Mr. Blue, Mr. Silver 3 Topaz, grey, v.07.204, orange, red, v.07.303	roll	112	25	-	no	or/red	10
32996	Ascard B5 eco, Mr. Green, mint	roll	58	25	-	no	or/red	20
32952	Ascard, Mr. Gold, Gold/3	roll	210	25	-	no	or/red	5
32968	BIOCARE 101G	roll	50	20	-	no	or/red	20
32989	300G, 3010	roll	63	30	-	no	or/red	20
32969	IE3	roll	80	20	-	no	or/red	10
33002	3030, 6010	roll	112	27	-	no	or/red	10
32992	1200	roll	210	30	-	no	or/red	5
32962	1210, 1215	pack	210	140	215	yes	or/red	10
33004	IE12, IE15	pack	210	150	200	yes	or/red	10
32966	BIOLIGHT BLT, 1203A, E 30	roll	80	20	-	no	or/red	10
32966	E70, E80	pack	210	295	150	yes	or/red	1
32950	BIONET Cardiocare/Cardiotouch	roll	215	25	-	no	or/red	5
32969	BIOSET-HORMAN 3800	roll	80	20	-	no	or/red	10
33050	Bioset 3600/3601/3700	pack	110	100	200	yes	or/red	10
33051	Bioset 8000 - 8100 - 9000 - 9100	pack	210	150	400	yes	or/red	5
32996	BTL 08/MT, 08/MD, 08/MD3	roll	58	25	-	no	or/red	20
32953	08 MT, MD	roll	112	23	-	no	or/red	10
32952	BTL 08/LC, 08/LT	roll	210	25	-	no	or/red	5
32954	BURDICK Atria 3100/6100, quest	pack	210	300	200	yes	or/red	1
32955	CARDIOLINE Elan 100	pack	112	100	300	yes	or/red	25
32956	Delta 1 plus	pack	60	100	300	yes	or/red	25
32957	Delta 1 plus	roll	60	30	-	no	or/red	20
32958	Delta 3 plus	pack	112	100	300	yes	or/red	25
32959	Delta 30	roll	183	30	-	no	or/red	5
32960	Delta 60 plus	roll	210	30	-	no	or/red	5
32961	Elan 2100, Delta 612	pack	210	280	200	yes	or/red	1
33053	ECG 100+	pack	100	150	200	yes	or/red	10
33054	AR2100 (VIEW/ADV) - 66010042	pack	210	140	200	yes	or/red	8
33055	ECG 200+	pack	210	295	180	yes	or/red	1
32963	CAREWELL ECG-1101B, 1101C, 1101G	roll	50	25	-	no	or/red	20
33025	ECG-1103B, 1103G, 1103L	roll	63	30	-	no	or/red	20
33058	ECG-1103GW, 1103LW	roll	80	30	-	no	or/red	10
33059	ECG-1106G, 1106L	roll	112	25	-	no	or/red	10
32950	ECG-1112L, 112M, T/12	roll	215	25	-	no	or/red	5
32969	COMEN CM300	roll	80	20	-	no	or/red	10
32965	CM600	roll	110	20	-	no	or/red	20
32992	CM 1200 A/B	roll	210	30	-	no	or/red	5
32966	CM 1200 A/B	pack	210	295	150	yes	or/red	1
32968	CONTEC 90A, 100G	roll	50	20	-	no	or/red	20
32969	300G, 300GT	roll	80	20	-	no	or/red	10
32970	600G	roll	110	20	-	no	or/red	10
32967	1200, 1201	roll	210	30	-	no	or/red	5
32963	DIMED LTD400	roll	50	25	-	no	or/red	20
32996	LTD410, Heartscreen 60G	roll	58	25	-	no	or/red	20
32964	LTD405S, LTD405W, LTD415 Heartscr. 80G	roll	80	25	-	no	or/red	10
32951	LTD418, Heartscreen 112	roll	112	25	-	no	or/red	10
32965	LTD440, LTD445/S	pack	110	140	143	yes	or/red	20
32960	LTD450, LTD455/S, LTD455/W	roll	210	30	-	no	or/red	5
32966	LTD450, LTD455/S, LTD455/W	pack	210	295	150	yes	or/red	1
32963	EDAN SE-1	roll	50	25	-	no	or/red	20
32964	SE-3	roll	80	25	-	no	or/red	10
32965	SE-601	pack	110	140	143	yes	or/red	20
32966	SE-6, 12, 1200 EXP	pack	210	295	150	yes	or/red	1
32960	SE-6, 12, 1200 EXP	roll	210	30	-	no	or/red	5
32962	SE/1201	pack	210	140	215	yes	or/red	10
32971	ELETTRONICA TRENTINA/CARDIETTE/CARDIOLINE Autoruler 12/1, comp. 1x12	roll	50	30	-	yes	blue	20
32972	Start 100	roll	130	27	-	yes	blue	10
32973	AR 600	roll	60	15	-	yes	blue	25

code	ECG MANUFACTURER AND MODEL	Type	Width mm	Length m	Sheet	Marker	Grid*	Min. order
32977	AR 600 Adv	pack	60	75	250	yes	blue	25
32974	AR 1200	roll	120	18	-	yes	blue	10
32978	AR 1200 (View/Adv)	pack	120	100	300	yes	blue	10
32975	Daedalus, AR2100	roll	210	20	-	yes	blue	5
32976	Daedalus, Start 200, AR2100	pack	210	150	200	yes	blue	8
32980	ESAOTE BIOMEDICA P 80 base	roll	90	28	-	no	or/red	10
32981	P 80 base	pack	90	70	400	yes	or/red	25
32982	P 80 Power, P 80 SIX	pack	210	280	215	yes	or/red	1
32983	P8000 base	pack	80	70	300	yes	or/red	20
32984	P8000 Power	pack	210	280	200	yes	or/red	1
32985	Archimed 4240, Archiwin	pack	210	300	200	yes	or/red	1
32986	Personal 120	pack	126	150	170	yes	white	20
32987	My Cardiopad base	pack	114	90	200	yes	or/red	20
33040	Esaote my Cardiopad 2157036	pack	210	140	180	yes	or/red	5
32988	FUKUDA ME - FUKUDA DENSHI 501A, FX121, FCP-500, OP18TE	roll	50	30	-	no	or/red	20
32989	FCP15, FCP11, OP110TE, OP119TE FCP2101, 2155, FX 2111, CASE10, FCP 7101, FX 7102	roll	63	30	-	no	or/red	20
32994	OP358TE, FCP/131, FX3010, FX3101, FX-8822	roll	145	30	-	no	or/red	10
32990	OP 111 TE, OP 115 TE, FX102	pack	50	75	400	yes	or/red	20
32991	OP 112 TE, FX 2111, FX 7101, FX 7102, FCP 2201 G	pack	63	75	400	yes	or/red	25
32992	FCP231, OP69TE, FX7402, FX7542, FX 8322	roll	210	30	-	no	or/red	5
32993	OP382TE, FX-3010, FX-8222	pack	145	75	400	yes	or/red	10
32965	OP222TE, FX7202	pack	110	140	143	yes	or/red	20
32996	GIMA Cardiogima 1M, 3M	roll	58	25	-	no	or/red	20
32953	Cardiogima 6M, colour	roll	112	23	-	no	or/red	10
32950	Cardiogima 12, 12M	roll	215	25	-	no	or/red	5
32999	HEWLETT PACKARD Page Writer 100/200, M1709A, M2483A	pack	210	300	200	hole	or/red	1
32988	40453 A, 43120	roll	50	30	-	no	or/red	20
32996	INNOMED HearthMirror IKO 3, HearthScreen 60 IKO, 60 G	roll	58	25	-	no	or/red	20
32964	HeartScreen IKO 80G-L, 80C-L	roll	80	25	-	no	or/red	10
32953	HeartScreen 112 C-D	roll	112	23	-	no	or/red	10
33002	KENZ - SUZUKEN Cardico 302/601	roll	112	27	-	no	or/red	10
33003	Cardico 302/601	pack	112	90	200	yes	or/red	20
32960	Kenz-Cardico 1210, 1211	roll	210	30	-	no	or/red	5
32988	103, R50-30R, TEC 8300	roll	50	30	-	no	or/red	20
33010	MARQUETTE - HELLIGE - GE MAC PC	roll	108	23	-	no	or/red	10
33011	Case 10-12-15, MAC 3000-5000	pack	215	280	300	hole	or/red	1
32966	Cardiosmart, MAC 1200/1600	pack	210	295	150	yes	or/red	1
33012	MAC 400, MAC 600	pack	80	90	280	yes	or/red	25
33013	MAC 800	pack	110	140	200	yes	or/red	25
33014	MINDRAY Beneheart R3	roll	80	20	-	no	or/red	10
33016	Beneheart R3	pack	80	70	200	yes	or/red	25
32966	BeneHeart R12	pack	210	295	150	yes	or/red	1
33017	MORTARA Eli 50	pack	50	70	200	yes	or/red	25
33010	Eli 100	roll	108	23	-	no	or/red	10
33019	Eli 210, 250, 280, 350, 380	pack	210	300	250	yes	or/red	1
33020	Eli 150	pack	108	140	200	yes	or/red	25
33021	Eli 230	roll	210	20	-	no	or/red	5
33025	NIHON KOHDEN CARDIOFAX 8110, 9620, 1150K	roll	63	30	-	no	or/red	20
33026	Cardio-fax GEM/1250/1950, ECG-9010/9020/9022	pack	210	140	215	yes	white	10
32962	Cardio-fax GEM/1250/1950, ECG-9010/9020/9022	pack	210	140	215	yes	or/red	10
33027	GEM 9010, 9020, 9022, 1250, 1950	pack	110	140	143	yes	white	20
33028	1500, 1550, 9110, 9130, 9132, 9320, 2250	pack	210	295	170	yes	white	1
32998	PHILIPS Page Writer TC/10	roll	110	25	-	no	or/red	10
32999	Page Writer TC/50 - TC/70	pack	210	300	200	hole	or/red	1
32997	Touch, TRIM I / II / III, Page Writer TC/20, TC/30	pack	210	300	100	hole	or/red	1
32953	PROGETTI EPG 612	roll	112	23	-	no	or/red	10
32996	EPG Basik-pocket	roll	58	25	-	no	or/red	20
33037	SCHILLER AT 1, AT 4	pack	90	90	390	yes	green	25
32982	AT 2, CS 200	pack	210	280	215	yes	or/red	1
33038	AT 10	pack	210	140	250	yes	green	10
32983	AT 101	pack	80	70	300	yes	or/red	20
32984	AT 102	pack	210	280	200	yes	or/red	1
33039	AT110, AT 10 Plus, AT 2 Plus	pack	210	140	150	yes	green	5
32987	Cardiopad, MS 2010	pack	114	90	200	yes	green	20
33040	Esaote my Cardiopad 2157036	pack	210	140	180	yes	or/red	5
32990	SIEMENS Cardiostat 1	pack	50	75	400	yes	or/red	20
32991	Cardiostat 11	pack	63	75	400	yes	or/red	25
32989	TRISMED Cardipia 201N	roll	63	30	-	no	or/red	20
33046	Cardipia 400, 406RS	roll	110	30	-	no	or/red	25
33047	Cardipia 800, 812RS	roll	215	30	-	no	or/red	5

*or/red: grid could be orange or red colour

SONY MEDICAL PRINTERS



Space saving design:
154x240xh 88 mm,
for flexible integration
into medical carts

33968

SONY

- 33968 SONY HYBRID GRAPHIC PRINTER UP-X898 MD - black/white
Produces A6 size printings in about 2 seconds, with superb print quality with 325 dpi and grey level of 256 steps. Can take both analogue video and digital signal inputs. 110-240 V AC, 50/60 Hz.

- 33993 SONY COLOUR PRINTER UP-25 MD
High quality analogue A6 Dye.

Sublimation Printer for use in medical applications.

An ideal technology for making high quality, accurate photographic prints.

See more info on www.gimaitaly.com



33993

SONY ORIGINAL PAPER



SONY

SONY VIDEOPRINTER PAPERS

- 72726 SONY PAPER - UPP-110 HD - box of 10 rolls
High density printing paper - 110 mm x 20 m
- 72727 SONY PAPER - UPP-110 HG - box of 10 rolls
High glossy printing paper - 110 mm x 18 m
- 72728 SONY PAPER UPP-110S - box of 10 rolls
- 72729 SONY PAPER UPP-110HA - box of 10 rolls
- 72735 SONY COLOUR PAPER UPC-21L
(4 ink rolls + 200 supports 144x100 mm)

MITSUBISHI ORIGINAL PAPER

- 72740 MITSUBISHI PAPER
K65HM-CE - box of 4



COMPATIBLE PAPERS FOR SONY AND MITSUBISHI PRINTERS



ULTRASOUND COMPATIBLE PAPER FOR VIDEOPRINTERS

Top quality thermal print media perfectly fitting Sony and Mitsubishi thermal printers.

Long lasting image durability for high storage durability
- high humidity and heat resistance for long storage
- strong resistance to water, finger prints and ultrasound gel drops.

Precise, high resolution image reproduction
- first class colour intensity for highest black colour density

- outstanding, bright, sharp and detailed medical image

- high glossy, brilliant, photorealistic reproduction

Trouble-free printing and long-term use of printer
- easy tearing along the cross direction

- minimum curling for flat photo media and easy filing

- built-in anti-electrostatic layer preventing thermal head damage.

code	Compatibility		Paper grade	Size mm x m	Minimum order
	SONY	MITSUBISHI			
72745	UPP-110HG	K91HG/KP91HG	high glossy	110x18	box of 5
72746	UPP-84HG	-		84x12.5	box of 10
72747	UPP-110HD	-		110x20	box of 5
72748	-	K65HM/KP65HM	high density	110x20	box of 5
72749	UPP-210HD	-		210x25	box of 5
72750	UPP110S	-	standard	110x20	box of 5
72751	-	K61S/KP61S/KP61B		110x20	box of 5



72745

72751

COMPATIBLE DEFIBRILLATOR ECG THERMAL PAPER - DIFFERENT BRANDS

code	MANUFACTURER AND MODEL	Type	Width mm	Length m	Sheet	Marker	Grid	Min. order	GIMA code	MANUFACTURER AND MODEL	Type	Width mm	Length m	Sheet	Marker	Grid	Min. order
33100	CORPLUS Corplus 3	roll	106	20	-	no	or/red	10	33102	PHILIPS Defibrillator MRX	roll	75	25	-	no	or/red	10
32968	MINDRAY Beneheart D3, D6	roll	50	20	-	no	or/red	20	33103	Heartstart XL	roll	50	30	-	no	or/red	20
33103	HEWLETT PACKARD 40457CD, Codemaster 100, XL	roll	50	30	-	no	or/red	20	33032	PHYSIO CONTROL Life Pack 8-9-10	roll	50	23	-	no	or/red	20
33029	NIHON KOHDEN Def. TEC 5521, 5531, BSM 2300, 3000	pack	50	100	200	no	or/red	25	33033	Life pack 11-12-15	roll	107	25	-	no	or/red	10
32988	Tech-8300	roll	50	30	-	no	or/red	20	32983	SCHILLER Defigard 6002	pack	80	70	300	yes	or/red	20
									33106	ZOLL Defii/1400 (P/N 8000-0300)	pack	90	90	200	yes	or/red	20

*or/red: grid could be orange or red colour

GIMA ULTRASOUND GEL



code	ULTRASOUND GEL	Minimum order
33269	Sterile ultrasound gel - sachet - 20ml - transp	box of 48
33271	Ultrasound gel - sachet - 20ml - transparent	box of 200
33270	Ultrasound gel - tube 60 ml - transparent	box of 12
33272	Ultrasound gel - tube 250 ml - blue	box of 40
33273	Ultrasound gel - tube 250 ml - transparent	box of 40
33274	Ultrasound gel - bottle 1 l - blue	box of 12
33275	Ultrasound gel - bottle 1 l - transparent	box of 12
33276	Ultrasound gel - tank 5 l - blue	box of 2*
33277	Ultrasound gel - tank 5 l - transparent	box of 2*
33278	Ultrasound gel - bag 5 l - blue	box of 4**
33279	Ultrasound gel - bag 5 l - transparent	box of 4**
33283	Pump for tank 5 l and bag 5 l	

*includes 2 empty bottles 250 ml ** includes 4 empty bottles 250 ml and 1 nozzle

GIMA ULTRASOUND GEL

Hypoallergenic, water soluble gel suitable for ultrasonography, doppler and defibrillator applications. It ensures the ultrasound waves come to the equipment display in a clear and uninterrupted way. Salt, formaldehyde, fragrance free.



GEL CLEANER

• 33281 GEL PROBE CLEANER 250 ml

It removes the gel left over the probe, makes the image clearer and extends the probe life. Thanks to the active agents contained, it prevents the bacteria to pass from patient to patient, and it ensures hygiene. Alcohol-free.



33281



COSMETIC GEL

33254



33253



33255



TECARTHERAPY CREAM

• 33251 TECARTHERAPY CREAM 1 l

It allows to reduce the contact impedance between the probe and the skin. The high conductivity ensures the best results both in the capacitive phase and in the resistive phase of the treatment. Preservatives and dyes used are non-toxic. Latex free.

33251



EEG PASTE

• 33262 EEG PASTE - 400 g

Used with EEG electrodes in EEG application for brain mapping. Thanks to the active substances in its content, it allows the electrode to cling to the strand of hair easily and provides conductivity. It is hypoallergenic, does not irritate skin, soluble in water and can be cleaned easily. Does not contain oil and oily substances. It has no toxic effects and odour.



33262

KONIX COSMETIC LASER & CAVITATION GEL

Laser & Cavitation gel reduces the pain that patients experience during depilation and makes the device last longer by cooling the device head and window. Thanks to the vacuum technology, its active substances and its high viscosity it preserves probe from damages. It is not affected by the body salt during the use, ensures an easy application.

Technical properties: it is hypoallergenic, does not irritate skin, is water soluble and easily cleanable. Oily substances, formaldehyde and salt free. No toxic effects and odourless.

code	COSMETIC LASER & CAVITATION GEL	Minimum order
33253	Cosmetic gel - tube 250 ml	box of 40
33254	Cosmetic gel - bottle 1 l	box of 12
33255	Cosmetic gel - bag 5 l	box of 4**
33283	Pump for bag 5 l	

** includes 4 empty bottles 250 ml and 1 nozzle for easy refill

GIMA PORTABLE, BIDIRECTIONAL, VASCULAR DOPPLER

- 33230 GIMA BIDIRECTIONAL DOPPLER NON STEREO with two probes: 4 and 8 MHz
- Continuous wave (CW) bidirectional doppler equipped with electronic probes for high sensitivity and low background noise.
- bidirectional graphic separation of flow (forward and reverse)
- LCD graphic display for real time display of forward and reverse flow in bidirectional or separate mode
- selectable amplitude scale: 1, 2, 4, 8 kHz during the test and before printing. Preset zero line
- 5 minutes (300 sec.) continuous and reviewable memorized test. Operator can select the most meaningful exam and print it.
- calculation of: heart rate, peak flow and mean flow
- simultaneous connection of high sensitivity probes
- internal rechargeable large capacity battery (Ni-Cd 1.8 Ah); the system can be operated during charging. Autonomy 8 hours
- footswitch for freezing or memorizing the graphs
- hardcopy may or may not include the parameter calculation
- printing time scale: 25 mm/s
- Hi-fi audio output for correct acoustic diagnosis

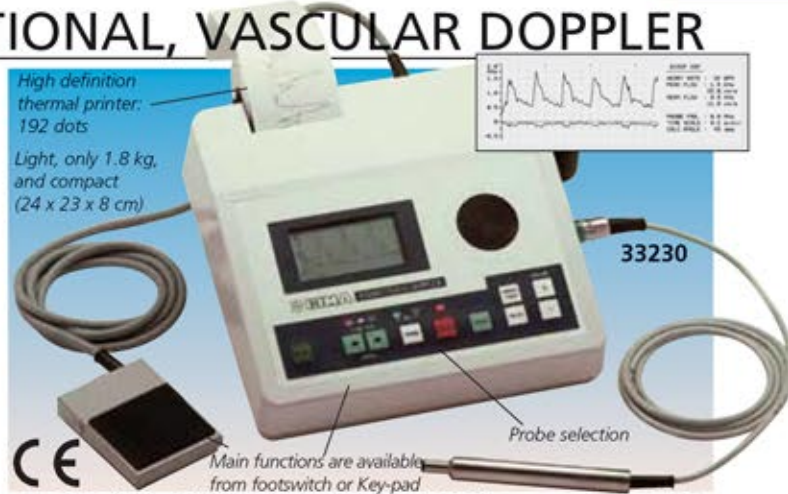

- 33240 GIMA BIDIRECTIONAL PROBE 4 MHz - spare for 33230
- 33241 GIMA BIDIRECTIONAL PROBE 8 MHz - spare for 33230
- 33250 THERMAL PAPER 58 mm x25m (pack of 5 rolls)

POCKET DOPPLER WITH INTERCHANGEABLE OR FIXED PROBES



TECHNICAL SPECIFICATIONS	
Ultrasound	Power supply
Frequency: 2, 5 or 8 MHz continuous wave	Battery 9V Alkaline (not included)
Transducer: 2 crystal narrow beam	Expected battery life: >9 hours
Output power: <15mW/cm ² SATA	Output
Audio Response: 300Hz - 4 KHz	Headset: Audio output to optional headset (not included)
Unit Controls	Material: ABS / Noryl
Keys: 1 Key (for unit on/off)	Size - weight: 150 mm by 75 mm - 299 g
Controls: rotary volume	Classification: Class I Type B - IEC 60601-1
Indicators: Yellow battery low LED	

GIMA POCKET DOPPLERS

Small, lightweight, high sensitivity pocket Doppler. Its probes are ideal for use by a General Practitioner, vascular specialist for routine vascular examination in ER for vessel location, or by specialists in diabetes, urology and gynaecology. Vascular flow signals and FHR are easily located using the transducer while internal signal processing minimizes noise artefacts. The flow signal is also available to the user via the built-in loudspeaker with output level controlled by rotary volume control. 2 years warranty.

Supplied in a nice bag with probe, cable, gel tube and 7 languages user manual: GB, FR, DE, IT, ES, GR, PT.

code	GIMA POCKET DOPPLERS
33120	DOPPLER V2005 with 5 MHz fixed vascular probe
33121	DOPPLER V2008 with 8 MHz fixed vascular probe
33123	DOPPLER V2000 (without probe)
33126	2 MHz interchangeable probe - foetal for V2000
33127	5 MHz interchangeable probe - vascular for V2000
33128	8 MHz interchangeable probe - vascular for V2000
29511	ON/OFF membrane switch spare for 33120/3

SONOTRAX DOPPLERS



code	DOPPLERS AND INTERCHANGEABLE PROBES - LATEX FREE
29490	SONOTRAX LITE DOPPLER - without probe - with bag
29491	SONOTRAX BASIC DOPPLER - with display - without probe - with carrying bag
29493	SONOTRAX PRO II DOPPLER with backlit display built-in audio recorder and rechargeable batteries, battery charger, carrying bag, without probe
29496	2MHz waterproof probe - gynaecology
29497	3MHz waterproof probe - gynaecology
29498	4MHz waterproof probe - vascular
29499	8MHz waterproof probe - vascular

SONOLINE COLOUR DOPPLER

• 29480 COLOUR SCREEN POCKET DOPPLER

- portable and lightweight
- built-in speaker
- TFT-LCD, real-time display of FHR
- three working modes: real-time FHR, average FHR and manual calculation
- display of FHR, bar graph and heart-beat waveform, red alarm for abnormal FHR
- low power consumption, continuously work for more than 8 hours with two "AA" batteries LR6 - 1.5 VDC
- indication for probe-off and low battery

- 29481 2 MHz WATERPROOF PROBE - gyn
- 29482 3 MHz WATERPROOF PROBE - gyn
- 29483 4 MHz WATERPROOF PROBE - vascular
- 29484 8 MHz WATERPROOF PROBE - vascular

TECHNICAL SPECIFICATIONS		
Ultrasound working frequency:	2 MHz ± 10%	
Fetal heart rate:	range: 50-240 bpm	accuracy: ± 2 bpm
	resolution: 1 bpm	
Alarm:	high limit: 160 bpm	low limit: 120 bpm
Ultrasound intensity:	< 5 mm/cm ²	
Auto power off after 1 minute no signal		
Dimension - weight:	135x92x29 mm - 245 g	

MINDRAY DP-10 AND DP-20 DIGITAL ULTRASOUND SYSTEM

DP-10 slim and smart

Good image quality, easy to use and lightweight to take it anywhere. It combines fashionable design, diagnostic confidence and economy.

DP-20 exceeds your expectations

Smart portable B/W ultrasound system with advanced features

Display modes and imaging processing:

Broadband, multi-frequency imaging: B, B/B, 4B, B/M, M

Imaging processing:

- multi-frequency probes for 2D imaging modes -
- iClear: speckle reduction image
- THI (Tissue Harmonic Imaging) with convex probe 33976 only

- TSI (Tissue Specific Imaging)

- zoom function: spot zoom, pan zoom

- ExFOV (Extended field of view)

Extended view of the anatomical structure on all convex and linear probes allow to discover better diagnostic information.

- iTouch (Auto image optimization)

User interface

- alphanumeric QWERTY keyboard with backlight
- trackball: speed presettable
- 8-segment TGC
- user defined blank keys: shortcut for easy access to menus

iStation™ intelligent workflow

Intelligent patient data management system

- integrated search engine for patient data
- detailed patient information review
- intelligent data backup/restore
- patient data/image sending, data deleting (USB, DVD, DICOM)
- exam managing: activate exam

Storage/review mode:

- image archive on hard disk and USB mobile storage medium, temporary saving in cine memory, directly transfer report to PC
- 2 USB ports

- multiple image formats: BMP, JPG, DCM, FRM, AVI, DCM, CIN

- iVision: demo player

- Cine review: auto, manual (auto review segment can be set), supports linked cine review for 2D, M images

- Cine memory capacity (max.)

- clip length presettable: 1-60 s

B mode: 11959 frames M mode: 110.0 s

Supplied with GB, IT manual and CD manual (GB, FR, IT, ES, PT, DE, RU, BR).



iScanHelper function

Dedicated inbuilt tutorial function to enhance ultrasound experience.

- wide selection of application specific exam planes
- anatomical illustrations
- standard ultrasound images
- scanning reference pictures
- tips on scanning and diagnosing

Optional PW doppler for probes 33976 (Convex), 33977 (Linear)

DP-10/20 support superb PW Doppler imaging to access blood flow in different clinical conditions.

With PW, doctors will be able to:

- differentiate non echoarea and blood vessels
- distinguish arteries and veins
- evaluate blood flow velocity for more comprehensive diagnosis
- Check the health of a fetus by blood flow evaluation of the umbilical cord

Features

Parameter adjustment: Gain, Sample volume size, Scale, Steer, Dynamic range, Wall filter, etc.

Measurement: Trace, HR, Velocity, PS/ED, PI, RI, etc.

33985



code	DIGITAL ULTRASONIC DIAGNOSTIC IMAGING SYSTEM
33970	MINDRAY DP-10 B/W system with 1-probe connector, 12.1" high resolution LED monitor, 2 USB port, 1 VGA OUT port, 1 video OUT, 1 S-Video OUT, software, without probe
33971	MINDRAY DP-20 portable B/W system with 1-probe connector, 12.1" high resolution LED monitor, 2 USB port, THI, iStation™, software package, without probe
PW DOPPLER	
33969	PW (Pulse Wave) doppler for probes 33976, 33977
ACCESSORIES	
33875	Needle guided brackets for Linear probe (33977, 33983)
33876	Needle guided brackets for Micro-Convex probe (33979, 33984)
33974	Lithium-ion rechargeable battery for DP-20
33985	Carrying bag for DP-10, DP-20, DP-30
33986	UMT-110 mobile trolley for DP-10, DP-20, DP-30
33968	SONY HYBRID GRAPHIC PRINTER X898 MD

PROBES DP-10 - DP-20		FREQUENCY (MHz)		● Main application									
code	Mindray code	Scanning method	Main freq.	Probe band width	ABDOMINAL OB / GYN	UROLOGY	SMALL PARTS	CARDIOLOGY	MSK	VASCULAR	PEDIATRIC	ORTHOPEDICS	INTRAOPERATIVE
33976	35C50EB	Convex	3.5	2.0 - 5.0	●	●	●	●	●	●	●	●	●
33977	75L38EB	Linear	7.5	5.0 - 10.0	●	●	●	●	●	●	●	●	●
33978	65C15EA	Micro-convex	6.5	5.0 - 8.5	●	●	●	●	●	●	●	●	●
33979	65EC10EB	Micro-convex	6.5	5.0 - 8.5	●	●	●	●	●	●	●	●	●
33980	35C20EA	Micro-convex	3.5	2.0 - 5.0	●	●	●	●	●	●	●	●	●
33983	75L53EA	Linear	7.5	5.0 - 10.0	●	●	●	●	●	●	●	●	●

TECHNICAL SPECIFICATIONS

- Dimension: 16x29xh 35.4 cm (6.3"x11.4"xh 13.9")
- Weight: 5.1 kg
- Display: 12.1" LED, high-resolution 1024x768
- Display language: DP-10, DP-20: GB, FR, DE, IT, ES, PT, RU, CZ, PL
- Power: AC100-240 V, 50-60 Hz
- Rechargeable lithium-ion battery (DP-20 only) - on request



MINDRAY DP-50 DIGITAL ULTRASOUND DIAGNOSTIC SYSTEM

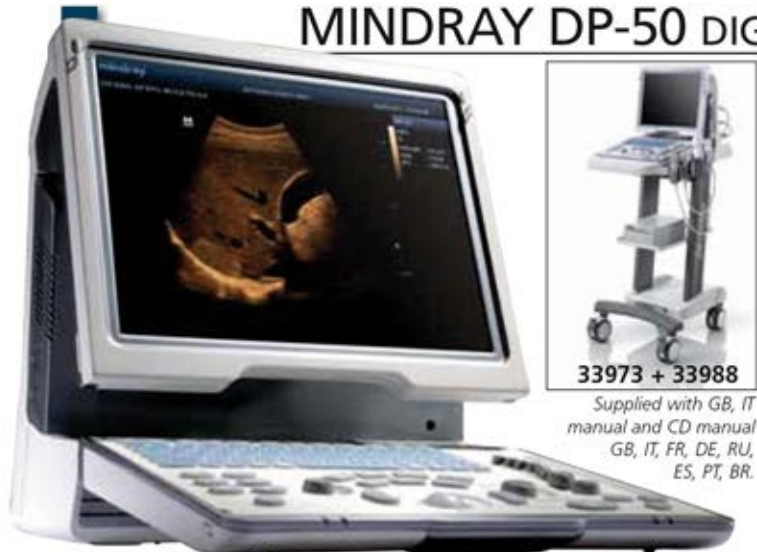

33973 + 33988
Supplied with GB, IT manual and CD manual
GB, IT, FR, DE, RU, ES, PT, BR.

- **33973 MINDRAY DP-50 PORTABLE ULTRASOUND** with 15" high resolution LCD monitor, 2 probe connectors, 320GB hard disk, 4 USB ports, multiple software package, without probes. **Imaging mode:** B, B/B, 4B, B/M, M
Image processing technology:
 - Phase Shift Harmonic Imaging
 - Tissue Harmonic Imaging
 - iBeam™ Spatial Compound Imaging
 - iClear™ Adaptive Speckle Suppression Imaging
 - iTouch™ Auto Optimization
 - Trapezoid imaging
 - iZoom™ Automatically expand the image to full screen
 - Slant scanning for linear probes (2D Steer)
- Wideband multifrequency probes:** continuously adjustable 2-14 MHz
- Intelligent Workflow/Storage/Review:**
 - iStation™ Intelligent patient data management system
 - 320 GB integrated hard disk for storage
 - 4 USB ports
 - Cine memory capacity (Max.) B mode: 10566 frames
 - M mode: 66.3 s
- **33972 MINDRAY DP-50 PT PORTABLE ULTRASOUND PHYSIOTHERAPY PRESET** with 15" high resolution LCD monitor, 2 probe connectors, 320GB hard disk, 4 USB ports, multiple software package, without probes. Same as 33973 but with real time ultrasound imaging (RTUI) for physiotherapy. Dedicated Physiotherapy presets: pelvic/hip/lumbar spine/shoulder/elbow/wrist/knee/ankle/Achilles tendon/cervical spine. Dynamic tracking therapeutic effects with image comparison function. Optimal musculoskeletal image quality

TECHNICAL SPECIFICATIONS	
Display:	15" LCD
Display language:	GB, FR, IT, ES, PT, RU, PL, CZ, TR, FI, DK, NO, SE, DE
Power:	AC 100-240 V - 50/60 Hz rechargeable lithium-ion battery - on request
Size and weight:	19x41.5x37.8 cm (7.5"x16.3"x14.9"); 7.7 kg (17 lb)

MINDRAY Z5 COLOUR DIAGNOSTIC ULTRASOUND SYSTEM

- **33880 MINDRAY Z5 COLOUR PORTABLE ULTRASOUND** with 15" high resolution LCD monitor, 2 probe connectors, 320GB hard disk, 4 USB ports, multiple software package, without probes. A colour doppler system that offers a rare combination of high performance and low cost. Superior image quality, affordability, versatility and mobility in a unique portable Doppler system:
- Versatility**
 - scanning modes: B, Colour, PW, Power, M, FreeXros M
 - image display modes: B, 2B, 4B, B/C, B/M, B/PW, Triplex PW
 - applications: ABD/OB/GYN/CAR/SML/URO/VAS/ORTH/EM/NERVE
 - transducer variety : Convex, Linear, Micro-convex, Endocavity
 - extended scanning angle with ExFov function
 - high frequency linear probe for superficial scanning
- Productivity**
 - iTouch: quick image optimization with one-click
 - iZoom: instant full screen zoom with one-click
 - iStation: patient database review and analysis platform
 - iStorage: direct data transfer to PC
 - Clipboard: easy play, preview and sharing of cineloop
 - Multiple image formats : BMP, JPG, DCM, AVI, DCM, CIN
- Mobility**
 - compact and streamlined design weighing 7.7kg
 - 15" LCD monitor with 30 degree tilt function
 - dual universal transducer connectors

- two level backlit keyboard for varying requirements
- can be packed in a convenient hand-carried bag for easy transportation
- 1.5 h uninterrupted scanning with rechargeable battery
- Supplied with CD manual: GB, FR, IT, ES, PT, DE, RU, BR.

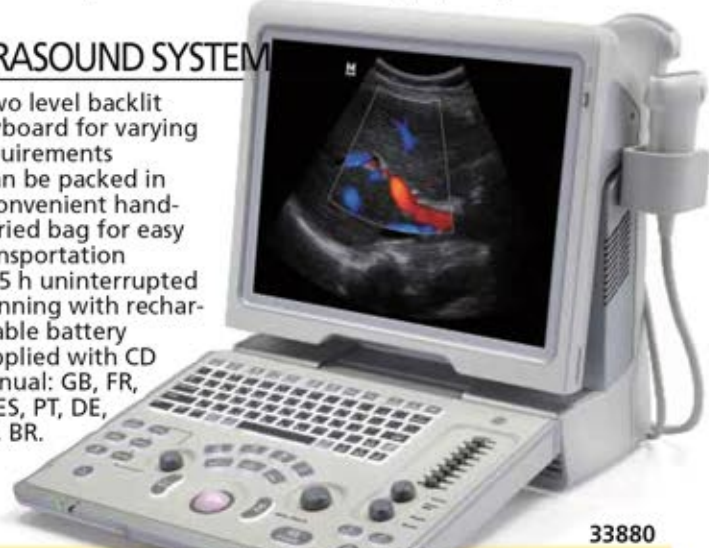

TECHNICAL SPECIFICATIONS	
Display:	15" LCD high resolution 1024x768
Software display + keyboard input:	GB, FR, IT, ES, PT, RU, PL, CZ, DE
Keyboard input:	TR, FI, DK, NO, SE
Power:	AC 100-240 V - 50/60 Hz rechargeable lithium-ion battery - on request
Size and weight:	19x41.5x37.8 cm (7.5"x16.3"x14.9"); 8.8 kg (19.4 lb)

PROBES AND ACCESSORIES FOR DP-50 AND Z5

code	ACCESSORIES for DP-50 and Z5
33875	Needle guided brackets for Linear probe (33983)
33876	Needle guided brackets for Micro-Convex probe (33984)
33975	Lithium-ion rechargeable battery for DP-50 and Z5
33987	Carrying bag for DP-50 and Z5
33988	UMT-150 mobile trolley for DP-50 and Z5
33968	SONY PRINTER UP-X898 MD FOR DP-50
33993	SONY COLOUR PRINTER UP-25 MD FOR Z5



33987
Trolley size:
44,5x53,5x
h 81 or 87 cm

Height selectable
(2 levels) when installing

PROBES DP-50 and Z5			FREQUENCY (MHz)		Main application									
code	Mindray code	Scanning method	Main freq.	Probe band width	ABDOMINAL	OB/GYN	UROLOGY	SMALL PARTS	CARDIOLOGY	MSK	VASCULAR	PEDIATRIC	PROSTATE	ORTHOPEDIC
33982	35C50EA	Convex	3.5	2.0 - 5.0	•	•	•	•	•	•	•	•	•	•
33983	75L53EA	Linear	7.5	5.0 - 10.0	•	•	•	•	•	•	•	•	•	•
33978*	65C15EA	Micro-convex	6.5	5.0 - 8.5	•	•	•	•	•	•	•	•	•	•
33984*	65EC10EA	Micro-convex	6.5	5.0 - 8.5	•	•	•	•	•	•	•	•	•	•
33990*	10L24EA	Linear array	10.0	8.0 - 14	•	•	•	•	•	•	•	•	•	•
34004	75L38EA	Linear	7.5	5.0 - 10.0	•	•	•	•	•	•	•	•	•	•



*not for DP-50PT

CHISON ECO1 AND ECO3EXP. DIGITAL ULTRASOUND SYSTEMS

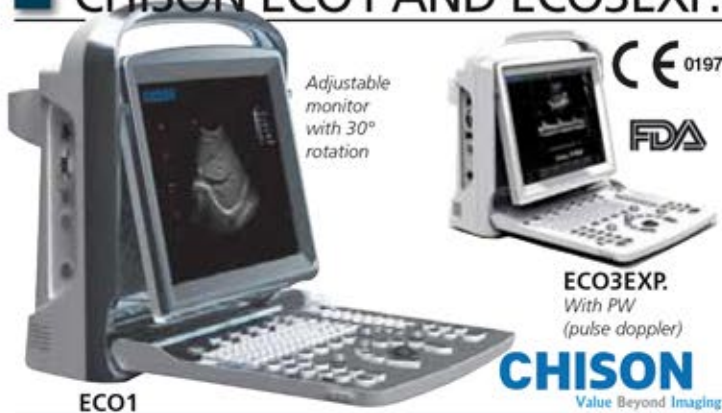

Adjustable monitor with 30° rotation



ECO3EXP. With PW (pulse doppler)

CHISON
Value Beyond Imaging

ECO1

code DIGITAL ULTRASOUND B&W DIAGNOSTIC IMAGING SYSTEM

33863	CHISON ECO1 with 1 probe connector without probe
33864	CHISON ECO3EXP. with 2 probe connectors without probe

STANDARD PACKAGE

	ECO1	ECO3EXP.	ECO5
12" high resolution LED monitor - B&W	•	•	
12" high resolution LED monitor - colour			•
8G memory card			•
Hot Key	•	•	•
PC printer connection	•	•	•
3 USB port	•	•	•
1 ethernet port	•	•	•
1 video out port, 1 VGA out port	•	•	•
1 footswitch port	•	•	•
Full screen display	•	•	•
2.5 hours rechargeable lithium-ion battery	optional	•	•
Power adaptor	•	•	•
Standard software package	•	•	•
Easy View image archive system	•	•	•
THI	•	•	•
PW (doppler function to detect blood flow speed)		•	•

TECHNICAL SPECIFICATIONS

Dimension and weight: 33.5x15.5x35 cm (13.2"x6.1"x13.8"); 6 kg
 Display: 12" LED, high resolution 1024x768
 Power: AC 100-240 V - 50/60 Hz
 rechargeable lithium-ion battery (ECO1 option, ECO3EXP. standard)

LANGUAGE - switchable by user

	GB	IT	FR	ES	DE	CZ	TR	CN	RU
Software	•	•	•	•	•	•	•	•	•
User manual	•	•	•	•	•	•	•	•	•

ECO1 Premium Design, Surprising Price

ECO3EXP. Premium Black&White Model with Doppler,

- ultra-compact and ultra-light weight, easy to carry
- latest LED screen technology, super bright images allow to easily view scan even outdoor.
- ergonomic monitor design, 30 degree rotation, adjustable.
- ultra-long battery life up to 2.5 hours, for outdoor scanning
- one-key to enlarge image to full screen, easy to view from distance
- streamlined workflow, easy to operate, 6-one-key to finish the cycle of diagnosis.

Display modes and imaging processing

B, B/B, 4B, M, B/M, PW (ECO3EXP. only) multi-frequency imaging

Imaging processing

- compound Imaging
- i-image intelligent image optimization
- THI (Tissue Harmonic Imaging)
- SRA (Speckle Reduction Algorithm)
- full digital beam-former
- full screen display
- trapezoidal
- automatic PW trace (ECO3EXP. only)
- Chroma
- AIO (Automatic Image Optimization)

User interface

- fold-up control panel and alphanumeric keyboard
- back-lit keyboard for good visibility in dark room
- interactive back-lighting
- indicator lights identify activated keys
- 8 TGC slides for easy adjustment
- short cut knob for quick adjustment (hot key user- defined)
- neat and clear keyboard layout, doctor can remember easily
- user defined preset

Streamlined workflow, one key to:

- select desired application with automatic preset
- optimize the image automatically (AIO)
- save still image and CINE loop
- print to PC printer* (laser or inkjet) or video printer
- Make report
- Measure

*See list of compatible printers on our websites

EASYVIEW™ Archive system

- image archive on hard disk and USB mobile storage
- 3 USB ports
- multiple image formats: BMP, JPG, DCM, CIN, AVI
- cine review: auto, manual (auto review segment can be set) for 2D, M, PW (ECO3EXP. only) images
- cine memory capacity (256 frames/10s)

CHISON ECO5 COLOUR DOPPLER DIGITAL ULTRASOUND SYSTEM

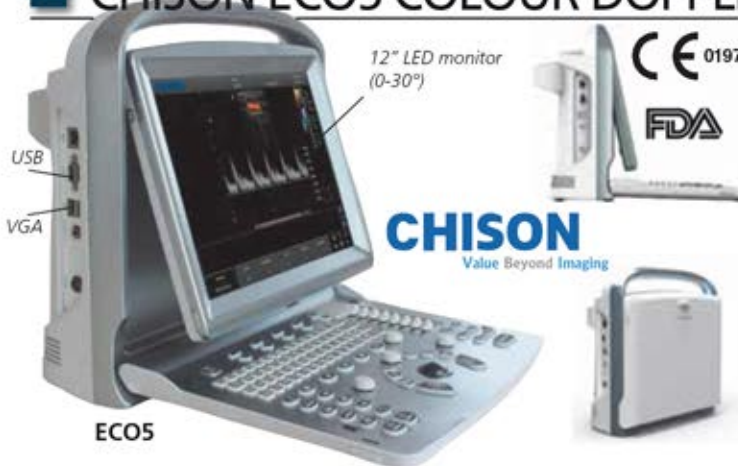

12" LED monitor (0-30°)



CHISON
Value Beyond Imaging

ECO5

• 33865 CHISON ECO5 Colour Doppler 12" high resolution color

LED monitor, 8G high speed memory, 3 USB ports, 2 probe connectors, EASYVIEW™ archive system, without probe
 Imaging model: B, B/B, 4B, B/M, M, CFM, PW

Imaging processing:

- MCI (Multiple Compound Imaging)
- i-image intelligent image optimization
- THI (Tissue Harmonic Imaging)
- SRA (Speckle Reduction Algorithm)
- full digital beam-former
- trapezoidal
- automatic PW trace
- Chroma
- full screen display model
- AIO (Automatic Image Optimization)

Other specifications as ECO3EXP.

TECHNICAL SPECIFICATIONS

Dimension and weight: 33.5x15.5x35 cm(13.2"x6.1"x13.8"); 6.5kg
 Display: 12" LED, high-resolution colour 1024x768
 Power: AC 100-240 V, 50-60 Hz
 Rechargeable lithium-ion battery

PROBES AND ACCESSORIES FOR CHISON ECO SERIES

PROBES ECO1 - 3 - 5			FREQUENCY(MHz)		Main application								
code	CHISON code	Scanning method	Main freq.	Probe band width	ABDOMINAL	OB/GYN	UROLOGY	SMALL PARTS	BASIC CARDIOL.	MSK	VASCULAR	PEDIATRIC	ORTHOPED.
33998	C3-A	Convex	3.5	2.5 - 5.0	•	•	•	•	•	•	•	•	•
33999	L7M-A	Linear**	7.5	5.3 - 10.0	•	•	•	•	•	•	•	•	•
33871	L7S-A	Linear***	9.0	5.3 - 11.0	•	•	•	•	•	•	•	•	•
33872	V6-A	Trans-vaginal	6.0	4.5 - 8.0	•	•	•	•	•	•	•	•	•
33997	MC6-A	Micro-convex	6.0	4.5 - 8.0	•	•	•	•	•	•	•	•	•
33873*	R7-A	Trans-rectal	7.5	5.0 - 10.0	•	•	•	•	•	•	•	•	•
33874	MC3-A	Micro-convex	3.0	2.5 - 5.0	•	•	•	•	•	•	•	•	•

*For ECO3EXP. and ECO5 only **With 40 mm footprint, general linear probe
 ***With 30 mm footprint for superficial tissue exams with higher resolution

code	ECO SERIES ACCESSORIES
33869	Rechargeable lithium-ion battery BT-2500 (2.5 hours)
33867	ECO trolley TR-9000
33868	Carrying bag
33866	Needle guided brackets - specify for which probe (for 33998-9, 33872-4 only)
PRINTERS	
33968	SONY UP-X898 MD B&W printer (for ECO1 and ECO3EXP.)
33993	SONY UP25MD colour printer(for ECO5)



33865 + 33867

CHISON QBit5 AND i8 ECOCOLOURDOPPLERS



CHISON
Value Beyond Imaging
CE 0197
FDA



• 33877 QBit5 ECOCOLOURDOPPLER - 15" flat high resolution LED monitor. Supplied with 2 probe connectors and 1 parking probe connector, trolley, keyboard, large image storage: 32 GB HardDisk, 6 USB ports, VGA format, without probes. Affordable and reliable colour doppler with advanced technologies: compound imaging, quad beam former imaging, Q-image, Q-flow, X-contrast providing superb images. The Streamlined workflow and ergonomic outlook design improve work efficiency.

Imaging modes:
- Power Doppler / Directional PD - B/BC
- CFM - PW mode - CW mode - full screen - duplex, triplex
- chroma B/M/PW/CW - B, 2B, 4B, B/M, M
- trapezoidal on linear probe
Image processing technology:
- Speckle Reduction Algorithm (SRA)
- direct print to PC or video printer
- automatic image optimizer (AIO)
- fusion harmonic imaging (FHI)

Special radiology function: 2D steer and super needle (optional)
Phased array probe and package
Phased array probe functions include CW, TDI, ECG, Colour M and complete calculation packages including PISA/Dp/Dt

code for QBit5	code for i8	PROBES Scanning Method	FREQUENCY (MHz)		Main application									
			Main freq.	Probe band width QBit5	Probe band width i8	ABDOMINAL	OB/GYN	UROLOGY	SMALL PARTS	CARDIOLOGY	TCD	PROCTOLOGY	PEDIATRICS	VESSELS
33953	33953	CONVEX	3.5	2-6.8	2.5-5.3	•	•	•						
33955	33955	LINEAR	7.5	4-15	5-10				•					•
33956	33956	MICRO-CONVEX (TRANSVAGINAL)	6.0	4-12	4-10.7				•					
33964	33964	MICRO CONVEX (BASIC CARDIAC)	3.0	2-6.8	2.5-6.4					•				•
-	33963	CARDIAC (PHASED ARRAY)	3.0	-	2.5-4					•				
33879	-	CARDIAC (PHASED ARRAY)	3.0	1.5-5.3	-					•	•			
33958	33958	PEDIATRIC	5.0	4-10.7	3.5-8									•
-	33959*	4D CONVEX	4.5	-	2.2-6.4	•	•							

*Spare for 33966

• 33965 i8 ECOCOLOURDOPPLER - 19" flat high resolution monitor Supplied with 4 probe connector, trolley, keyboard, large image storage: 500 GB HardDisk, 6 USB port, DVD-RW, VGA format, I-image, Cardiac Package, without probes. Digital colour Doppler System with professional features: I-IMAGE improves image quality and offers ECG Intelligent I-image optimization.

Imaging mode:
- B, 2B, 4B, B/M, M
- CFM, Power doppler, Directional PD - B/BC mode
- PW mode, CW mode (with cardiac probe) - panoramic
- instant triplex, duplex, quadplex
- trapezoidal on linear probe - chroma B/M/PW/CW

Image processing technology:
- Tissue Harmonic Imaging (THI) on all probes
- Speckle Reduction Algorithm (SRA)
- Multiple Compound Imaging (MCI)

Wideband multifrequency probes
Continuously adjustable, 2.5-12 MHz
Operating voltage: 100-240 V, 50-60 Hz

Cardiac Package (colour M, CW, steering M, ECG, TDI, IMT)
• 33966 i8 ECOCOLOURDOPPLER+4D PROBE AND PACKAGE
Same as 33965 but with 4D real time imaging composed of 3D pictures with addition of live motion and probe 4D convex (33959).
• 33993 SONY UP - 25 MD COLOUR PRINTER A6 for i3, i8, QBit5
• 33968 SONY UP-X898 B/W PRINTER for i3, i8, QBit5



CHISON 600M PORTABLE ULTRASOUND



• 33930 CHISON 600M PORTABLE ULTRASOUND
10" SVGA monitor with two probe connectors, 256 frames cine memory, USB port, VGA port, without probes
- zooming and measurement functions (max scanning depth: 252 mm)
- wide applications: GYN, urology, abdominal, small parts
- 4-steps sweep speeds for cardiac study: 2s, 4s, 6s, 8s
- 4-steps zoom with depth control: x0.8, x1.0, x1.5, x2.0

- various measurements: distance, circumference, area, volume
- full Ob/Gyn software included: 7 EDD tables (BPD, GS, FL, AD, HC, AC, CRL), G.A. (fetal age) from 4-43 weeks
- fetal weight, fetal heart rate measurement
- imaging reversing: up/down, left/right, positive/negative
- power supply: 110-230 V, 50-60 Hz
• 33968 SONY PRINTER UP-X898 MD • 33901 TROLLEY FOR 33930

code	PROBES Outlook	Scanning Method	Main freq.	FREQUENCY (MHZ) 4-Step Multi-frequency	Main application					
					ABDOMINAL	OB/GYN	UROLOGY	SMALL PARTS	BREAST	VESSELS
33932	CONVEX	3.5	2.5/3.5/4.0/5.0	•	•	•				
33933	LINEAR	7.5	5.0/6.0/7.5/9.0				•	○	•	

Lightweight: only 7 kg (size: 42x27x25 cm)

SONOTOUCH™ 10.4" TOUCH ULTRASOUND COLOUR DOPPLER

• 33919 SONOTOUCH™ 30 - colour doppler with built-in probe connector, 10" high contrast LED monitor, 16 G memory, 3 USB port, video, LAN port, without probe. Lightweight, portable, small size, touchscreen ultrasound devices.



- Main features:
- display mode: B, B/B, 4B, B/M, M, Colour and PW mode. In the M or B/M mode, 4 steps sweep speeds.
 - multi-step display magnification, depth enhancement
 - setting adjustment of total gain, and 8 segments of TGC slides for selection and adjustment
 - multifocal firing focus, edge enhancement, frame averaging, compound
 - image freezing and storage function, built-in 16 GB high-speed memory and external USB memory disk can be connected to the system for mass storage through USB port. Stored images can be retrieved for analysis.
 - 256 frames of real-time images can be stored in Cine-memory
 - probe scanning direction can be changed and the image can be reversed in left/right, up/down direction
 - measurements of distance, area, circumference, volume, OB etc. Automatic calculation of OB and cardiology. Direct display of gestation age, expected date of child delivery and direct measure of heart rate
 - real-time clock displays date and time automatically
 - display of body marks with corresponding probe position indication
 - annotation function in image area of the screen. Special annotation terms for different exam-mode can be added according to user's requirement
 - built-in rechargeable lithium Ion battery. Life up to 2.5 hours
 - full touch screen display

Button free screen and waterproof front panel

Select your applications from visual icons



Refine the image with easy, touch driven TGC, focus and depth

Take measure with your fingers, no trackball (accuracy 1 mm)

Adjustable angle stand converts into carrying handle



code	PROBES			FREQUENCY (MHz)		Main application					
	Scanning Method	Main freq.	Probe band width	ABDOMINAL	OB/GYN	UROLOGY	CARDIOLOGY	VASCULAR	SMALL PARTS	MSK	PAEDIATRIC
33922	CONVEX	3.5	2.5 - 5.0	•	•	•					
33923	LINEAR	7.5	5.0 - 10.0					•	•	•	
33924	MICRO-CONVEX	3.0	2.5 - 5.0	•	•	•					
33926	TRANSVAGINAL	6.0	4.0 - 7.5		•	•					
33927	MICRO-CONVEX	6.0	4.0 - 8.0								•

CHISON Q5, Q9 AND Q9 4D PORTABLE COLOURDOPPLER

• 33950 CHISON Q5 COLOURDOPPLER with 2 probe connector, 15" high resolution monitor, 500 GB hardisk, 2 USB port, LAN port, Video, TV, VGA out, I-Image, without probe.



Portable digital colour doppler with high professional features:
Imaging mode:
 - B, 2B, 4B, B/M, M
 - CFM
 - PW mode
 - Instant Triplex, Duplex
 - Power Doppler / Directional PD
 - Trapezoidal
 - Chroma B/PW

Image processing technology:
 - Multi-beam former technology
 - I-image™: image optimization technology
 - THI

- Speckle reduction algorithm (SRA)
 - Multiple compound imaging (MCI)
 Operating voltage: 110-240 V, 50-60 Hz. Manual: GB, IT, on request FR.

• 33952 CHISON Q9 COLOURDOPPLER
 Same as Q5 but with TDI quantitative cardiac dialysis, THI on all probes, double phase digital beam, DPDBF, IMT calculation, needle enhancement, 500 GB hard disk, quadplex, Cardiac Package. Suitable for cardiac use.

Cardiac Package (ECG software, CW, Free Steering M, colour M, TDI) included.

• 33951 CHISON Q9+4D COLOURDOPPLER
 Same as Q9 but with 4D real time imaging.
 • 33901 TROLLEY FOR Q5, Q8, Q9



code for Q5	code for Q9	PROBES			FREQUENCY (MHz)		Main application					
		Scanning Method	Main freq.	Probe band width	ABDOMINAL	OB/GYN	UROLOGY	SMALL PARTS	ENDOCAVITY	CARDIOLOGY	PEDIATRICS	VESSELS
33954	33954	CONVEX	3.5	2.5 - 5.3	•	•	•					
33955	33955	LINEAR	7.5	5.0 - 12.0				•				•
33956	33956	TRANSVAGINAL (MICRO-CONVEX)	6.0	4.0 - 12.0		•	•					
-	33957	CARDIAC (PHASED ARRAY)	3.0	2.5 - 5.0						•		
33958	33958	PEDIATRIC	5.0	3.5 - 9.6							•	
33959	33959	4D CONVEX	4.0	2 - 6.8	•	•						

For probes purchased separately from ultrasound it is necessary to supply the serial number of the device 287

GIMA VITAL SIGNS MONITORS

"Vital Signs" is a line of small multi-parameter patient monitors, which can monitor the vital physiological parameters: non-invasive blood pressure (NIBP), pulse oxygen saturation (SpO₂), electrocardiogram (ECG) and temperature (TEMP).

Features:

- small size, clear and bright display (14x17 cm) for remote view
- up to 12,000 groups of NIBP measurements can be stored and listed
- up to 96 hours of SpO₂ and HR trend curve can be displayed
- built-in rechargeable battery, 2 hours use (35120-2) or 3 hours (35124)
- USB port (35124 only)
- optional built-in thermal printer

code	MONITOR	SpO ₂	NIBP	ECG	TEMP
35120	VITAL-S	•			
35121	VITAL-SNT	•	•		•
35122	VITAL-SNET	•		•	
35124	VITAL PRO-SNET	•	•	•	•
35125	Printer* - optional	* Installation done by Gima if ordered with monitor.			
35141	Paper 5.1 cm x 12 m - box of 5	Need service if ordered later.			
35126	Lead acid re-chargeable battery - spare for 35120-2				
35129	Lithium re-chargeable battery - spare for 35124				
35135	Adult SpO ₂ probe - spare				35120
35136	Pediatric SpO ₂ probe				35128
35137	ECG cable - spare				
35140	NIBP cuff - 10-19 cm - pediatric				
35142	NIBP cuff - 18-26 cm - pediatric XL				
35139	NIBP cuff - 21-35 cm - adult				
35143	NIBP cuff - 27-42 cm - adult XL				
35127	Trolley - adjustable 73 to 113 cm				
35128	Rail clamp				

STANDARD ACCESSORIES	35120	35121	35122	35124
- Adult SpO ₂ probe	•	•	•	•
- NIBP adult cuff	•	•	•	•
- Temperature probe - skin type	•	•	•	•
- ECG cable + 10 ECG electrodes	•	•	•	•
- Lead acid battery	•	•	•	•
- Lithium battery	•	•	•	•
- Manual (English)	•	•	•	•



TECHNICAL SPECIFICATIONS

NIBP
 Technology: Oscillometric method
 Standard measurement range:
 Systolic: Adult: 50 - 240 mmHg
 Diastolic: Adult: 15 - 180 mmHg
 MAP: Adult: 25 - 200 mmHg
 Measurement mode: Manual, Auto, STAT
 SpO₂ measurement range: 0 - 99%
 SpO₂ measurement accuracy:
 75 - 99% ±2%
 50 - 74% ±3%
 Low perfusion performance: 0.4%
 Pulse rate measurement range:
 30bpm-240bpm

Pulse rate measurement accuracy:
 ± 2 bpm or 2% whichever is greater
Size: 18.5 x 18 x h 29 cm **Weight:** 2.4 kg
ECG and TEMP
 Heart rate range: 20 - 300 bpm
 TEMP measurement range: 25 - 45 °C
Accuracy: ±2 bpm or 1% whichever is greater (ECG) ±0.2 °C (TEMP)
Power
 AC power supply: 100 - 250V, 50/60 Hz
 Internal power supply: 12 VDC (rechargeable)
Battery:
 12V 2,3AH (lead-acid battery) (35120-2)
 11.1 V, 4,400 mAh lithium battery (35124)

PC-3000 MULTI-PARAMETER PATIENT MONITOR



- 35134 PC 3000 MULTI-PARAMETER PATIENT MONITOR
- 7" high resolution colour TFT display, 5-channel waveform display
- standard parameters: ECG, RESP, SpO₂, NIBP, 2-TEMP, PR; Arrhythmia analysis and ST segment analysis
- up to 12,000 groups parameter data & 60-hour ECG waveform storage and recall
- 1,000-hour graphic and tabular trends for all parameters
- 7-channel ECG simultaneous waveforms display
- protection against interference from defibrillator, electrosurgical knife
- adult / pediatric measurement modes
- visual and audible alarms; networking capability
- carrying handle with bed-hooks

Internal software: GB, IT. On request: FR, ES, PT, PL, CZ, TR, CN.

STANDARD ACCESSORIES		
1 ECG cable	1 NIBP cuff	10 Disposable electrodes
1 SpO ₂ probe	1 Li-ion battery	1 Body surface temperature transducer
1 AC power Adapter	1 Power cable	User manual

code	ACCESSORIES - SPARES
35135	Adult SpO ₂ probe - spare
35136	Pediatric SpO ₂ probe
35137	ECG cable - spare
35138	Li-ion battery - spare
35140	NIBP cuff - arm circumf. 10-19 cm - pediatric
35142	NIBP cuff - arm circumf. 18-26 cm - pediatric XL
35139	NIBP cuff - arm circumf. 21-35 cm - adult - spare
35143	NIBP cuff - arm circumf. 27-42 cm - adult XL

TECHNICAL SPECIFICATIONS

NIBP Monitoring
 Measuring method: Automatic measurement by oscillating method
 Initial cuff inflation pressure: Adult mode: <180mmHg infant mode: <120mmHg
 Overpressure protection limit: Adult mode: 300mmHg Infant mode: 240 mmHg

Measuring range
 Systolic pressure: Adult: 40-225 mmHg Infant: 40-200 mmHg
 Diastolic pressure: Adult: 20-215 mmHg Infant: 20-165 mmHg
 Mean arterial pressure: Adult: 10-195 mmHg Infant: 10-150 mmHg
 Measurement accuracy: Systolic ±10% Diastolic ±10% MAP ±10%
 Measurement mode: Manual, Auto, STAT
 Automatic measuring: 1-240min

TEMP Monitoring
 Measuring range, accuracy: 25.0 - 45.0 °C, ±0.2°C

SpO₂ & Pulse Rate Monitoring
 Transducer: dual-wave length LED
 SpO₂ measuring range: 35%-100%
 Low perfusion capability: 0.4%-5%
 SpO₂ display accuracy: 70%-100% ±3%
 PR measuring range: 30bpm-250bpm
 PR measuring accuracy: ±2bpm

ECG Monitoring
 Heart rate measurement: ±0.4 mVp - ±5 mVp
 Heart rate display range: 20 - 250bpm
 Display accuracy*: ±1% or ± 2 bpm, whichever is greater
 Heart rate alarm delay time: ≤10s
 Sensitivity selection: Auto, x1/2, x1, x2, x4 tolerance: ≤5%
 Sweeping speed: 12.5 mm/s, 25 mm/s, 50 mm/s tolerance: ≤10%
 Common-mode rejection ratio: ≥89 dB
 Frequency response: Monitoring mode: 0.5 - 40 Hz
 Diagnostic mode: 0.05 - 75 Hz

RESP Monitoring
 Monitoring range, accuracy: 0 - 120 rpm, ±5% or 2 rpm, whichever is greater
 RESP alarm range: 0 - 100 bpm ±10%

Other Technical Specifications
 Power supply: 100 - 250 Vac, 50/60 Hz <80 VA
 Networking port: serial/Net port



Wide option of screen views available

UP 7000 MULTI-PARAMETER PATIENT MONITOR

ECG+RESP+SpO₂+
2 TEMP+PR



- 35145 MULTI-PARAMETER PATIENT MONITOR ECG, RESP, SpO₂, 2 TEMP, PR
- 12.1" high resolution colour TFT display
- 3 channel ECG amplification
- arrhythmia analysis and ST segment analysis
- up to 800 groups parameter data & 24-hour ECG waveform storage and recall
- 480-hour graphic and tabular trends for all parameters
- 7 trace ECG waveforms simultaneous display
- protection against interference from defibrillator
- adult/pediatric measurement modes
- visual and audible alarms
- built-in rechargeable battery
- built-in thermal printer
- multilanguage internal software: GB, FR, IT, ES, PT, PL, CZ, TR, RU, CN



code	ACCESSORIES AND SPARES
35135	Adult SpO ₂ probe
35136	Pediatric SpO ₂ probe
35137	ECG cable
35140	NIBP cuff - arm circumf. 10-19 cm - pediatric
35142	NIBP cuff - arm circumf. 18-26 cm - pediatric XL
35139	NIBP cuff - arm circumf. 21-35 cm - adult
35143	NIBP cuff - arm circumf. 27-42 cm - adult XL
35126	Lead acid rechargeable battery - spare
35141	Paper 5.1 cm x 12 m - box of 5
35150	Trolley - adjustable 73 to 113 cm



STANDARD ACCESSORIES		
- Adult SpO ₂ probe	- Re-chargable battery	- Disposable electrode
- NIBP adult cuff	- Printer	- Dust-protective mantle
- Temperature probe - skin	- Power supply cable	- Manual (GB, IT)
- Temperature probe - rectal	- ECG cable 5 leads (RA - LA - LL - PL - C)	

TECHNICAL SPECIFICATIONS			
NIBP Monitoring			
Measuring method:	Oscillometric		
Measuring range:	Systolic pressure:	Diastolic pressure:	Mean arterial pressure:
adult:	40-255mmHg	10-220mmHg	20-215mmHg
pediatric:	40-200mmHg	10-110mmHg	20-165mmHg
TEMP Monitoring			
Measuring range:	25.0°C-45.0°C ±0.2°C		
Response time:	≤ 150 sec		
SpO₂ & Pulse Rate Monitoring			
SpO ₂ measuring range:	35% - 100%		
PR measuring range:	30bpm-240bpm ±2bpm		
ECG Monitoring			
Heart rate measurement:	±0.4mVp-±5mVp		
Heart rate display range:	20bpm-250bpm		
RESP Monitoring			
Measuring method:	Thoracic impedance		
Monitoring range:	0rpm-120rpm		
Monitoring accuracy:	±5% or ±2rpm whichever is greater		
Other Technical Specifications			
Power supply:	100-250Vac, 50/60Hz		
Power consumption:	<80 VA		
Display mode:	12.1 inches TFT color LCD		
Alarming mode:	Audible-visual alarm		
Networking port:	Ethernet port		
Size - weight:	29x31.5x15 cm - 3.9 kg		

CMS 8000 CONTEC PATIENT MONITOR

ECG+RESP+SpO₂+
NIBP+2 TEMP+PR



- 35151 CMS 8000 PATIENT MONITOR ECG, RESP, SpO₂, PR, NIBP, DUAL CHANNEL TEMP
- 12.1" TFT colour LCD display
- multilanguage interface (GB, IT, FR, DE, ES, PT, NL, PL, CZ, TR, RO, RU)
- adult/pediatric/neonate measurement modes
- 8 channel waveform synchronous display
- 7 lead ECG waveform on one screen
- anti-motion, anti-ambient light interference digital SpO₂ technology
- AC/DC rechargeable lithium battery
- manual/AUTO/continuous NIBP measurement mode
- standard/OXY- graph/Trend-graph/big characters and view bed interfaces

Size: 314x145x264 mm
Weight: 3.9 kg

code	ACCESSORIES AND SPARES
35149	Adult SpO ₂ probe - 3 m cable - spare
35107	Neonate SpO ₂ probe <3 kg - reusable
35108	SpO ₂ extension cable
35113	Pediatric NIBP cuff 18-26 cm
35114	Adult NIBP cuff 25-35 cm
35115	Adult large NIBP cuff 33-47 cm
35116	Thigh NIBP cuff 46-66 cm
35154	Rectal temp probe - optional
35155	Skin temp probe - spare
35156	ECG cable - spare
35157	Printer - optional
35158	Trolley
35159	Rechargeable lithium battery - spare
32968	Printer paper roll 50 mm x 20 m



STANDARD ACCESSORIES	
- Adult SpO ₂ probe	- ECG cable
- NIBP adult cuff	- power supply cable
- NIBP extension tube	- manual (GB, IT, ES) on request (PT, TR)
- Temperature probe - skin	- ECG electrodes
- Rechargeable lithium battery	

TECHNICAL SPECIFICATIONS	
ECG	Measurement period in CONT mode: 5 min
5-lead, dual channel, 3-lead, single channel	Measurement alarm: 10-270 mmHg
Scan speed: 12.5 mm/s, 50 mm/s	SpO₂
ST segment monitoring	Measurement and alarm range: 0-100%
Measurement and alarm range: -2.0mV ±2.0mV	Measurement accuracy: 70-100% ±2%
RESP	PR
Method: R-F (RA-LL) impedance	Measurement and alarm range: 30-250 bpm
Measurement and alarm range: 0-150 rpm	TEMP
Apnea alarm: 10-40 sec	Channel: dual channel
NIBP	Measurement and alarm range: 0-50 °C
Method: oscillometry	Power supply: 110-240 V - 50/60 Hz
Mode: manual/AUTO/continuous	Safety classification: Classe I type CF
Measurement interval in AUTO mode:	Defibrillation-proof applied part
1/2/3/4/5/10/15/30/60/90/120/240/480/960 min	

BM7 PREMIUM PATIENT MONITOR FOR INTENSIVE CARE



• 33774 BM7 MONITOR 12.1" touch screen LCD display - 7 channels Premium patient monitor for intensive care.

Superior features:

- touch screen operation display
- individual sweep speed setting for each parameter
- 168 full hours of trend data storage
- 4-split large multiple display modes
- oxy/CRG
- drug calculation
- screen freeze ON-OFF
- ST level analysis histogram

High performances:

- ECG, SpO₂, NIBP, Respiration, 2 Temp, 2 IBP
- Sidestream EtCO₂ - optional
- 13 Arrhythmia analysis modes
- high performance Suntech NIBP
- Li-ion battery with longer life time (1.5 hrs continuous operation)
- possibility to connect to BM central monitoring system see page 291

• 33725 CART - adjustable height, basket included

• 33709 Li-ion BATTERY 11.1 V - spare

Same accessories and probes as BM5 monitors, see page 292, 293.

STANDARD ACCESSORIES

5-lead patient Cable (MECA5 (AHA), MACES (IEC))
Electrodes - box of 10
NIBP extension tube (3m)
Reusable Adult Cuff (25-35 cm)

Reusable Pediatric Cuff
SpO₂ extension cable (2m)
Reusable Adult SpO₂ probe
DC adapter (18 VDC, 2.5A)

Li-ion 11.1 V battery
Thermal printer
2 paper roll
User manual: GB, IT

TECHNICAL SPECIFICATIONS

MONITOR
Display, Resolution 12.1" color TFT. 800x600 pixels
Dimension 322x250x224.8 mm
Weight Approx. 4.5 kg
Trace 6 waveforms: 2x ECG, SpO₂, RR or EtCO₂, 2xIBP
Sweep speed: 6.25, 12.5, 25, 50 mm/sec
Categorized alarms (3 priority levels)
Visual alarm lamp handle and heart beat tone
QRS beep & SpO₂ pulse beep
SpO₂ pitch tone
Battery status, external Power LED
Touch screen, rotary knob
Interfaces
Connectors DC input connector: 18 VDC, 2.5 A
Defibrillator Sync. Output:
- Signal level: 0 to 5 V pulse
- Pulse width: 100 ± 10 ms
LAN digital output for transferring data
External VGA monitor connection
DC output 5VDC, 1A Max
Battery
Rechargeable Li-ion battery,
1.5 hours continuous operation
Thermal Printer
Speed: 25, 50 mm/sec,
paper width: 58 mm
168 hours trends, 20 cases of
10 sec alarm waveform
USB memory storage
Internal language (selectable) GB, FR, IT, ES, DE,
CZ, PL, PT, RO, BG, HU, TR, RU, CN, KR

ECG
Leads type 3-lead, 5-lead
Lead selection 3-lead: I, II, III
5 lead: I, II, III, aVR, aVL, aVF, V
3-lead: 1 channel
5-lead: 2/7 channel
ECG waveform
Adult: 15-300 bpm
Neonate/pediatric: 15-350 bpm
Heart rate accuracy
±1 bpm or ±1% whichever is greater
Sweep speed
6.25, 12.5, 25, 50 mm/sec
Filter
Diagnosis: 0.05-120 Hz
Monitoring: 0.5-40 Hz
Moderate: 0.5-25 Hz
Maximum: 5-25 Hz
S-T segment detection range -2.0 to 2.0 mV
Arrhythmia analysis ASYSTOLE, VTACH, VFIB,
BIGEMINY, ACCVNT, COUPLE, IRREGULAR, PAUSE, PVC, RONT, TRIGMINY, VBRADY, SHORTRUN
Pacemaker detection mode
Indicator on waveform display (user selectable)
Protection
Against electro-surgical interference and defibrillation
RESPIRATION
Method Thoracic impedance
Channel selection RA-LA or RA-LL
Measurement range 5-120 breath per minute
Accuracy ±1 breath per minute
Apnea alarm Yes
SpO₂ range 0 to 100%; (70 to 100% ±2% digits)

Pulse rate range 0 to 254 bpm ±2 bpm
NIBP SUNTECH
Method Oscillometry
Operation Mode manual / Automatic / Continuous
Pressure measurement range 0-300 mmHg
Safety pressure: Adult: 300 mmHg
Neonate: 150 mmHg
Blood pressure: Adult pressure: 20 to 220 mmHg
Measurement range: Pulse rate: 30-220 bpm
Pediatric pressure: 20-160 mmHg
Pulse rate: 30-220 bpm
Neonate pressure: 20-130 mmHg
Pulse rate: 30-220 bpm
Accuracy: The static pressure measurement is within ±3 mmHg
Meets ANSI/AAMI SP 10 2002
TEMPERATURE
Measurement range: 10 to 45°C (59 to 113°F) ±0.1°C
Compatibility YSI SERIES 400 temperature probes
IBP
Channels 2
Measurement range: -50 to 300 mmHg
Accuracy <100 mmHg ±1 mmHg
>100 mmHg ±1% of reading
Pulse rate measurement range 0 to 300 bpm
Zero balancing Range: ±200 mmHg
Accuracy: ±1 mmHg
Drift: ±1 mmHg of over 24 hours
Transducer sensitivity: 5 µV/mmHg
Pulse rate measurement range: 0 to 300 bpm

BM1, BM3, BM5, BM7 MONITOR ACCESSORIES

code	ACCESSORIES FOR BM1, BM3, BM5, BM7				
33738	NIBP	Extension cable, 3 m (necessary for all cuffs)		33735	
33735		Adult cuff - 49x15 cm - need ext. cable 33738			
33736		Child cuff - 35x11 cm - need ext. cable 33738			
32848		Obese cuff 62x75.5 - need ext. cable 33738			
33737		Kit of 3 neonatal cuffs* - needs cable 33738			
32810	Temp	Mini cuff 16x5 cm - needs 33738+33739		32810	
32811		Mini cuff 23x5 cm - needs 33738+33739			
33739		Metal connector (necessary for mini cuff)			
33771		Temperature sensor 3.0 m, skin type <i>Compatible with Drager MM15114, MM15822, GE 21733601, Philips HP21059B, Nihon Kohden P242A, Datascope 0206-02-0003</i>		33771	
33772		Temperature sensor 3.0 m, rectal type			
33743	Paper	Thermal paper 57.5 mm, 38 Ø			
33742	Battery	Ni-MH 12V battery - up to January 2006** - BM3, BM3 Plus		33742	
33715		Ni-MH 12V battery - Since January 2006** - BM3, BM3 Plus			
33717		Li-ion battery - Since Sept. 2007** - new BM3, Plus, BM5			
33798		Li-ion battery 11.1 V - 6 cell for EtCO ₂ - for 33782 only			
33710		Li-ion battery 11.1 V for BM1			
33709		Li-ion battery 11.1 V for BM7			
33747	Adapter	AC adapter for BM3, BM5, BM7			

**Date is approximative. Please select battery according to picture and specifications

* Cuff 3.3-5.6 cm, 4.2-7.1 cm, 5-10.5 cm

COLOUR MULTIPARAMETER MONITORS



Bed-rail hook Ergonomic handle

Pacemaker detection indicated on ECG display

58 mm built-in printer for both real time and trend date (Speeds: 25-50 mm/sec)

Battery status indicator - continuous operating time 1.5 h

- 33718 GIMA BM3 MONITOR (7" - 800x480 - TFT display)
- 33719 GIMA BM3 VET MONITOR - VETERINARY

ECG+SpO₂+NIBP+RESP+TEMPERATURE

- GIMA monitors are configured with
- 7" colour TFT LCD for a clear view
 - Individual sweep speed setting for each parameter
 - 128 full hours trend data stored
 - SpO₂ measurement with very low perfusion detection and pulse beep
 - 2 traces ECG
 - screen freeze on/off
 - connection to Central monitoring system using LAN or W-LAN
 - Li-ion Battery (for 1.5 hours continuous operation)
 - High-performance ECG detection and analysis
 - input impedance for dry skin or electrode patch
 - ST level, PVC count real-time display
 - 3 kinds of Arrhythmia analysis
 - pacemaker detection function
 - Enhanced data management
 - graphical and tabular trends
 - 20 cases per 10 sec alarm waveform stored, reviewed and printed
 - Internal software selectable in GB, DE, FR, IT, PT, PL, RO, HU, ES, CZ, BG, RU, TR, CN
 - User manual: GB, IT (on request: ES, FR, DE).



Angle of plate adjustable

Height of cart is adjustable

CE 0123

33725

Moving cart increase flexibility around the ward or department.

See temperature sensors, cuffs, batteries and accessories at page 290, 293

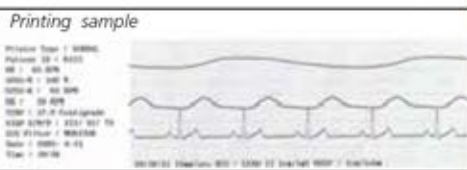

Printing sample



Easy mounting with bed-rail hook



Direct connection of external monitor through optional card

STANDARD ACCESSORIES	33718	33719
3 lead patient cable (ECG)	•	• vet
Disposable electrodes: 10 pcs	•	•
NIBP tubing - 3m	•	•
Reusable adult cuff 25-35 cm	•	•
Reusable child cuff	•	•
Set of 3 veterinary cuffs	•	•
SpO ₂ sensor - reusable	•	• vet
SpO ₂ sensor extension cable 2 m	•	•
Thermal printer 58 mm	•	•
DC adaptor (18 VDC, 2.5A)	•	•
Battery	•	•
User manual: GB, IT	•	•



ST analysis display mode

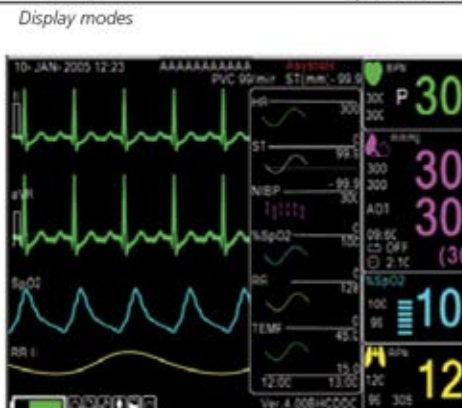

Trend display mode



Large parameter display mode

PATIENT CENTRAL SYSTEM (up to 31 monitors)

It allows the user to monitor and extract the exact status of several patients simultaneously at a place. Convenient bidirectional communication allows you to admit new patient information, set alarms at either central station or patient monitor.

- 33745 WIRE CENTRAL SYSTEM (PC, monitor, 16 port switch and software)
- 33746 LAN CABLE - 3 m
- 33767 LAN CABLE - 30 m

One for any monitor to be connected. Customized cable length on request.

- 33758 WIRELESS CENTRAL SYSTEM (PC, monitor, wireless router and software)
 - 33759 WIRELESS CONNECTION KIT (Ethernet converter and power cable)
- One for any monitor to be connected.

TECHNICAL SPECIFICATIONS

GENERAL	
Display:	7" colour TFT 800x480 pixels
Dimensions - Weight:	238x250xh 163 mm - 3.1 kg
Trace:	4 waveforms: 2*ECG, SpO ₂ , Respiration
Indicators:	Sweep speed: 6.25, 12.5, 25, 50 mm/sec Categorized alarms (3 priority levels) Visual alarm, QRS beep & SpO ₂ Pulse beep Percent (%) SpO ₂ , pitch tone, Battery status, External Power LED
Thermal printer:	25, 50 mm/sec (paper width 58 mm)
Battery:	Rechargeable Li-ion battery Operating time: 1.5 hours (fully charged)
Interfaces:	LAN digital output for transferring data DC input connector: 18 VDC, 2.5 A max
Operating voltage:	100-240 V, 50-60 Hz
Data storage:	128 hours trends, 20 cases of 10 sec alarm waveform
ECG	
Lead type:	3-lead, 5-lead (option)
Lead selection:	3-lead I, II, III 5-lead I, II, III, aVR, aVL, aVF, V (option)
Heart rate range:	Adult: 30 to 300 bpm, Neonate/Pediatric: 30 to 350 bpm
Heart rate accuracy:	± 1bpm or ± 1%, whichever is greater
Sweep speed:	6.25, 12.5, 25, 50 mm/sec
Filter:	Diagnosis: 0.05 to 150 Hz - Monitoring: 0.5 to 40 Hz Moderate: 0.5 to 25 Hz - Maximum: 5 to 25 Hz
S-T segment detection range:	-2.0 to 2.0 mV

Arrhythmia analysis:	ASYSTOLE, VTACH, VFIB
Pacemaker detection mode:	Indicator on waveform display (user selectable) Against electro-surgical interference and defibrillation
Protection:	
SpO ₂	
% Saturation Range:	0% to 100% ± 2 digits (70% to 100%)
Pulse rate range:	30 to 254 bpm ± 2 bpm
NIBP	
Technique:	Oscillometric
Measurement Modes:	Manual/automatic/continuous
Pressure range:	0 to 300 mmHg ± 3 mmHg
Measurement range:	Adult pressure: 20 to 260 mmHg Pediatric pressure: 20 to 230 mmHg Neonatal pressure: 20 to 120 mmHg
Respirations	
Method:	Thoracic impedance
Range:	5 to 120 breath/min
Accuracy:	± 1 breath/min
Apnea alarm:	yes
Temperature Unit	
Range:	0° to 50°C (32°F to 122°F)
Accuracy:	± 0.1°C (25°C to 50°C), ± 0.2°C (0°C to 24°C)
Compatible with:	YSI Series 400 Temperature Probes



33745

BM5 MULTIPARAMETER MONITOR WITH EXTENDIBLE PARAMETERS

- 33777 GIMA BM5 MONITOR - 10.4" TFT display - 7 ch ECG
 - 33779 GIMA BM5 VET MONITOR - 10.4" TFT display
 - high-performance ECG analysis
 - ST level PVC count display
 - 13 kinds of Arrhythmia analysis
 - 7 channels
 - 10.4" colour TFT screen with 6 waveforms
 - visible alarm lamp handle
 - SpO₂ technology with very low-perfusion detection
 - SpO₂ pitch tone
 - 58 mm built-in chart recorder
 - graphical and tabular trends of printing
 - LAN or wireless LAN
 - 128 full hours trend data stored
 - direct DC input for vehicle transport
 - Li-ion battery with long life time
 - connection to central monitoring system
 - selectable software language (GB, DE, FR, IT, PT, PL, RO, HU, ES, CZ, BG, RU, TR, CN).
- Standard accessories as BM3 monitor, page 291. Other accessories page 290-293.



ECG+SpO₂+NIBP+RESP+ 2 TEMP, optional 2 IBP + EtCO₂ MODULE

Visible alarm lamp handle

12 Channel display



Arrhythmia analysis: VTAG, VFIB, ASYSTOLIC Pacemaker detection indicated on the ECG waveform display

code	TEMPERATURE, EtCO ₂ AND IBP KIT
33771	Temperature sensor 2.75 m - skin type
33772	Temperature sensor 2.75 m - rectal
33741	Exacon temperature sensor 2.75 m - rectal
33796	EtCO ₂ Sidestream module for 33714, 33777/8/9
33790	Intubated Filter Line H - adult - box of 10 for 33796
33791	Intubated Filter Line H - infant - box of 10 for 33796
33792	Non intubated CO ₂ nasal cannula - adult - box of 10 for 33796
33793	Non intubated CO ₂ nasal cannula - pediatric - box of 10 for 33796
33794	Non intubated CO ₂ +O ₂ nasal cannula - adult - box of 10 for 33796
33795	Non intubated CO ₂ +O ₂ nasal cannula - pediatric - box of 10 for 33796
33786	Single line monitoring kit (catheter)
33787	IBP Kit - disposable - single
33788	IBP Kit - reusable (not autoclavable) - single
33789	IBP Kit - reusable (not autoclavable) - double

33790
Airway adapter set with dehumidification tubing for intubated adult
Suitable also for VET (dog, horse)

33792
CO₂ nasal carinula - adult

33794
CO₂+O₂ nasal carinula - adult

33791
Airway adapter set with dehumidification tubing for intubated infants
Suitable also for VET (cat, puppy)

33793
CO₂ nasal carinula - pediatric

33795
CO₂+O₂ nasal carinula - pediatric

GENERAL		TECHNICAL SPECIFICATIONS FOR MONITOR 33777 - 33779	
Dimensions/Weight: 270x185xh 250 mm/4 kg	Heart rate range: Adult: 30-300 bpm Neonate/pediatric: 30-350 bpm	Respirations Range: 5 to 120 breaths/min	Accuracy: ± 1 breath/min
Trace: 6 waveform (ECGx2, SpO ₂ , RR or EtCO ₂ , IBPx2)	Heart rate accuracy: ± 1 bpm or ± 1%, whichever is greater	Apnea alarm: yes	Temperature Unit Range: 15° to 45°C (59°F to 113°F)
Indicators: categorized alarms (3 priority levels), visual alarm lamp handle, heart rate, SpO ₂ pulse pitch tone, battery status, external power LED	Sweep speed: 6.25, 12.5, 25, 50 mm/sec	Temperature Unit Accuracy: ± 0.1°C	Compatible with: YSI Series 400 Temperature Probes
Thermal printer: 25, 50 mm/sec (paper width 58 mm)	Filter: Diagnostic mode: 0.67-150 Hz Monitoring mode: 0.67-40 Hz Surgical mode: 5-25 Hz	IBP - option Channels: 2	Measuring range: -50 to 300 mmHg
Battery: Li-ion (2 hours operating time)	S-T Segment detection range: -2.0 to 2.0 mV	Measuring range: ± 1 mmHg (<100 mmHg)	Measuring accuracy: ± 1% of reading (>100 mmHg)
Interfaces: LAN digital output for transferring data, Nurse call system connection, defibrillator sync. output	Arrhythmia analysis: Asystole, Vtach, Vfib, Bigeminy, Accent Couplet, Irregular, Pause, Pvc, Ront, Trigeminy, Vbrady, Shortrun (120 kinds (33779 only))	Measuring accuracy: ± 1 mmHg	Pulse rate counting range: 0 to 300 beats/min
DC input connector: 12 to 18 VDC, 2.5A max	Diagnostic analysis: Indicator on waveform display (user selectable)	Zero balancing: range ± 200 mmHg	accuracy ± 1 mmHg
Operating voltage: 100-240 V, 50-60 Hz	Pacemaker detection mode: (user selectable)	drift ± 1 mmHg over 24 hours	Respiration accuracy: ± 1 breath per minute
SpO ₂ % Saturation Range: 0% to 100%	Protection: against electrosurgical interference and defibrillation	Transducer sensitivity: 5µV/V mmHg	
Pulse Rate Range: 0 to 254 bpm	NIBP Technique: Oscillometric with linear deflation	Measurement mode: Sidestream	
SpO ₂ Accuracy: 70% to 100% ± 2 digits	Measurement Modes: Manual-Automatic-Continuous	Measurement range: 0-150 mmHg, 0 to 19%	
Pulse Rate Accuracy: ± 2 bpm	Measurement range: Adult pressure: 20 to 260 mmHg Pediatric pressure: 20 to 230 mmHg Neonate pressure: 20 to 120 mmHg	Respiration range: 2-150 bpm	
ECG Lead type: 3-lead, 5-lead (33777), 10-lead(33779)	Cuff pressure display: 0 to 300 mmHg	Accuracy: ± 5%, 41-70 mmHg	
Lead selection: 3-lead: I, II, III (33777/79)	B.P. measurement range: Systolic: 40 to 270 mmHg Mean: 20 to 230 mmHg Diastolic: 10 to 210 mmHg	Respiration accuracy: ± 10%, 101-150 mmHg	
10-lead: I, II, III aVR, aVL, aVF, V1, V2, V3, V4, V5, V6 (33779 only)	Adjustable Cuff Inflation Pressure		
ECG Waveforms: 3-lead 1 channel (33777/79)			
5-lead: 3/7 channels (33777/79)			
10-lead: 3/12 channels (33779 only)			

BM1: SLIM AND LIGHT MONITOR WITH STRONG MOBILITY

- 33714 GIMA BM1 MONITOR SpO₂+NIBP optional Temp. and EtCO₂
- Professional multiparameter monitor in compact size:
- only 60 mm (2.36 inch) thick and 1.0 kg (2.2 lb)
- easy mounting to an IV pole
- 4.5 hours battery operation (rechargeable Li-ion)
- top handle and rear grip
- monitoring mode and spot check mode
- 4.3" color TFT monitor for clear view 480x272 pixels
- touch key and wheel navigation
- external VGA output for large LCD monitor (option)
- saves 128 hours trend and 400 cases
- multilanguage selectable software (GB, FR, IT, ES, DE, PL, PT, RO, BG, HU, CZ, RU, TR, CN, KR)
- highly advanced CO₂ monitoring technology
- plug and play EtCO₂ module
- Same accessories of BM line. SpO₂, TEMP, EtCO₂, NIBP technical specifications same as BM5.
- 33710 Li-Ion RECHARGEABLE BATTERY - spare

SpO₂ + NIBP optional TEMP and EtCO₂

Supplied with NIBP adult cuff (25-35 cm) with 3 m extension hose, SpO₂ adult finger probe with extension cable (2 m) DC adapter (15 VDC, 2.0 A) pole mount bracket, shoulder strap, rechargeable battery.



Size: 190x125x60 mm
Weight: 1 kg



ECG CABLES FOR BM GIMA AND BIONET MONITORS

code	ECG CABLES FOR BM3 (33718, 33719, 33720, 33721, 33722, 33723, 33724, 33780, 33781)	ACCESSORIES FOR MONITOR BM3, BM5, BM7	
		NEW (after 6/2006)	OLD (before 6/2006)
33711	3-lead patient cable kit (cable+snap connectors 33748)	<p>33713 Vet cable kit</p> <p>33760 Vet clip connect</p> <p>33762 Cable</p> <p>33748 Snap connect</p>	<p>33727 Vet cable kit</p> <p>33752 Vet clip connect</p> <p>33726 cable kit</p> <p>33750 Snap connect.</p>
33712	5-lead patient cable kit (cable+snap connectors 33749)		
33726	3-lead patient cable kit (cable+snap connectors 33750)		
33728	5-lead patient cable kit (cable+snap connectors 33751)		
33727	3-lead veterinary cable kit (cable+3 clips connectors)		
33713	3-lead veterinary cable kit (cable+3 clips connectors)	<p>33712 cable kit</p> <p>33761 Vet clip connect</p> <p>33763 Cable</p> <p>33749 Snap connect</p>	<p>33728 cable kit</p> <p>33753 Vet clip connect</p> <p>33751 Snap connector</p>
33748	3-lead snap connectors for 33711 - spare - new		
33749	5-lead snap connectors for 33712 - spare - new		
33750	3-lead snap type connectors for 33726 - spare - old		
33751	5-lead snap type connectors for 33728 - spare - old		
33752	Vet 3-lead clip type connectors for 33726-7 - spare - old		
33753	Vet 5-lead clip type connectors for 33728 - spare - old		
33760	Vet 3-lead clip type connectors for 33713 - spare - new		
33761	Vet 5-lead clip type connectors for 33712 - spare - new		
33762	3-lead patient cable		
33763	5-lead patient cable		
ECG CABLES FOR BM5-BM7 (33777, 33778, 33779)			
33764	3-lead patient cable kit (cable + snap connector)		
33765	10-lead patient cable kit (cable + snap connector) only 33778		
33766	3-lead veterinary cable kit (cable + clip connector)		

BM1, BM3, BM5, BM7 SpO₂ SENSORS - NELLCOR COMPATIBLE

code	SpO ₂ SENSORS FOR ALL BM MONITORS	SpO ₂ REUSABLE PROBES	
33730**	Adult reusable finger sensor (> 45 kg) Nellcor comp. - 7 pin	<p>7 pin</p> <p>33730</p>	<p>33731</p>
33731	Pediatric reusable finger sensor (15-45 kg) - Nellcor comp.		
33732	Vet reusable sensor - clip <i>**Not compatible with Nellcor NPB40 and N65</i>		
AVAILABLE OTHER NELLCOR AND NELLCOR OXITECH REUSABLE COMPATIBLE SpO₂ SENSORS - see page 295			
code	EXTENSION CABLES FOR BM SpO ₂ SENSORS	SpO ₂ EXTENSION CABLES	
33733	Extension cable*, 2 m (7 pin small SpO ₂ connector) up to 2005	<p>33733</p> <p>for units sold before Oct. 2005</p>	<p>33734</p>
33734	Extension cable*, 2 m (6 pin SpO ₂ connector) sold in 2005/6/7		
33716	Extension cable*, 2 m (7 pin big SpO ₂ connector) since 2007 <i>*Necessary for all probes. Please select correct one</i>		

NELLCOR COMPATIBLE DISPOSABLE SpO₂ SENSOR

All probes are supplied in sterile pack with 70 cm cable.



code	NELLCOR COMPATIBLE DISPOSABLE SpO ₂ PROBES (not compatible with Nellcor Oximax)
33755	Disposable neonate/adult probe - under 3 kg (neonate foot) - over 40 kg (adult finger)
33756	Disposable infant probe - 3-20 kg
33757	Disposable pediatric probe - 10-50 kg
33754	Disposable adult probe - over 30 kg

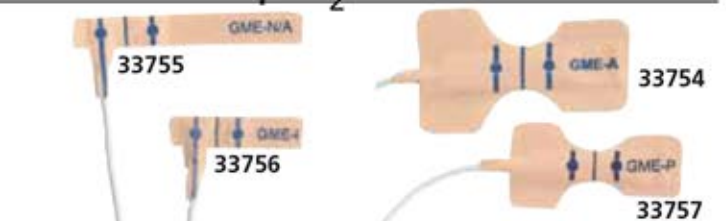

TECHNICAL SPECIFICATION SpO ₂ SENSORS	
Range of SpO ₂ measurement:	70%–100%
Accuracy:	70%–100% ±2%; below 70%: unspecified
Range of pulse measurement:	30–250 bpm
Accuracy:	±2 bpm of 2% (select larger)
Optical Sensor:	red light (wavelength is 650–670 nm, 6.65 mW) infrared (wavelength is 880–910 nm, 6.75 mW)

WRIST OXIMETER

• 34340 WRIST PULSE OXIMETER - with software

Small and lightweight wrist Oximeter available for home and clinical long-term and comfortable monitoring. It can be simply worn on the patient's wrist as a watch to start the monitoring and can be used during sports to measure SpO₂ and pulse rate (PR).

- audible and visual alarm with adjustable alarm limits
- trend review function of SpO₂ and PR
- selectable storage modes: 1 group/1s, 1 group/4s, and 1 group/8s
- up to 500 hours storage for SpO₂ and PR data in default mode (1 group/8s)
- clock setting and date display function
- software to download and store all measurements on PC integrated
- removable finger probe
- not suitable for pediatric use

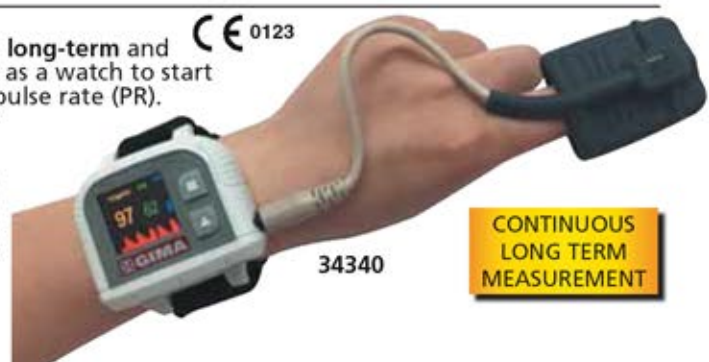

PC-300 SPOT CHECK BLUETOOTH MONITOR

Standard:
SpO₂, PR, NIBP,
TEMP

Optional ECG,
GLUCOMETER

35162



FDA 510 (K)
CE 0476



Bluetooth 2.0
and 4.0 standard

Memory of
6,000 NIBP measures





• **35162 PC-300 SPOT CHECK MONITOR**
PC-300 handheld Spot-check monitor measures SpO₂, Pulse Rate, NIBP and TEMP. Widely used in hospitals, clinics and family daily measurement. Equipped with Bluetooth and USB interface, allows to transfer data to PC, tablets and smartphone (Android and iOS).

- up to 6000 groups NIBP data storage, up to 100 different patients (each user can store 999 measurement records)
- quick ear probe TEMP measurement result in 5 seconds
- data transfer to PC/Smartphone by USB or Bluetooth
- optional NIBP pediatric cuff and SpO₂ pediatric probe
- optional ECG and Glucometer
- built-in rechargeable lithium battery
- communication protocols available on request

STANDARD ACCESSORIES

- SpO₂ adult probe
- NIBP adult cuff
- Ear thermometer (probe covers not included)
- Lithium battery with charger
- Carrying bag
- User manual: GB, FR, IT, ES



code	PC-300 ACCESSORIES	
35164	SpO ₂ pediatric probe - optional	
35165	SpO ₂ adult probe - spare	
35166	NIBP pediatric cuff 10-19 cm - with extension cable - optional	
35167	NIBP adult cuff 22-30 cm - spare	
35170	Ear infrared thermometer	
35171	Ear probe cover - box of 500	
35172	Lithium battery - spare	
PC-300 ACCESSORIES: glucose and ECG (optional)		
23890	Glucose monitor On Call Plus II* - IT, GR	
23891	Glucose monitor On Call Plus II* - GB, FR	
23892	Glucose monitor On Call Plus II* - ES, PT	
23895	Glucose monitor Kit On Call Plus II* - IT, GR	
23896	Glucose monitor Kit On Call Plus II* - GB, FR	
23897	Glucose monitor Kit On Call Plus II* - ES, PT	
23910	Glucose strips - box of 25	
23912	Glucose strips - box of 50	
23913	Glucose strips - box of 100	
35176	Glucose monitor USB cable	
35178	ECG module** needs 33248	
33248	ECG pin lead cable 3 leads	

TECHNICAL SPECIFICATIONS	
SpO₂	
Measuring range:	35%-100%
Accuracy:	±3% (70-100%)
Pulse Rate	
Measuring range:	30-240 bpm
Accuracy*:	±2% or ±2 bpm (whichever is greater)
*Root-mean-square value of deviation according to ISO 1919	
NIBP	
Pressure range:	0-300 mmHg (0-39.9kpa)
Accuracy:	±3 mmHg
Measuring range:	Systolic pressure: 60-240 mmHg Diastolic pressure: 30-180 mmHg
TEMP	
Measuring range:	32-43.0°C
Accuracy:	±0.2°C (35-42°C) - ±0.3°C (other)
Measuring time:	<5 s
ECG (Optional)	
Heart Rate measuring range:	30-240 bpm
Heart Rate accuracy:	±2 bpm or ±2% whichever is greater
Display scale:	5.0 mm/mV ±10%
Common-mode rejection ratio (CMRR):	≥60 dB
Blood Glucose (Optional)	
Measuring range:	20 to 600 mg/DL
SEE other specification at page 5	
Power Supply	
Battery:	3.7 V built-in Li-ion battery
Operating voltage:	3.6-4.2 VDC
Operating current:	≤800 mA
Charger:	100 - 240 VAC, 50/60 Hz, 5 VDC or USB

See glucose monitor accessories at page 5
*Needs USB cable 35176 to connect to PC-300

See electrodes at page 277-278
**ECG module can be used without 3 leads cable in palm mode

PALM SAT® 2500A NONIN PULSE OXIMETER

• **35086 PALM SAT® 2500A PULSE OXIMETER with rubber reusable adult probe and alarm.**
A compact versatile and reliable pulse oximeter designed and tested to exceed all durability requirements.

Main features:
- Pure Sat® technology offers accuracy & speed in getting a reading, even with varying skin pigmentations or polish and is able to monitor, with declared accuracy in challenging conditions, such as motion & low perfusion, for all patients - it is tested to assure performance in challenging conditions, such as drop and liquid ingress (IPX 2). Granted by US Army/Air Force Aeromedical certification
It also features: audible and visual alarms, 72 hour memory, long battery life (60 hours) or rechargeable battery for 40 hours
Supplied with multilanguage cd-rom manual: GB, FR, IT, DE, ES, PT, GR, NL, PL, NO, FI, DK, SE.

TECHNICAL SPECIFICATIONS	
SpO ₂ range:	0% to 100% ±2 (70-100% without movement)
Pulse rate range:	18 to 321 bpm ±3 (18-300% without movement)
Power:	4AA alkaline batteries 1.5 V (for 60 hours use) optional NiMH rechargeable battery (for 40 hours use)
Size:	7x13.8x3.2 cm Weight: 213 g

code	ACCESSORIES SAT 2500
35087	Adult reusable rubber probe (12.5-25.5 mm) - 1 m cable
35088	Pediatric reusable rubber probe (10-19 mm) - 1 m cable
35089	Charger stand with NiMH battery pack, plug kit
35082	NVISION software for data management (GB)
35083	Adaptor for USB - PC connection



Bright LED display of SpO₂ and pulse rate

Audible and visible alarms



Easy 2 button operation

Three-coloured signal quality indicator



Blinking alarm silence indicator
Low battery indicator

Rugged rubberized case with IPX 2 level of liquid ingress protection

35086

35086 + 35089

REUSABLE COMPATIBLE SpO₂ SENSORS FOR ALL BRANDS 0123



code	OEM - Brand	N	Sensor type	Cable length	Connector type	Compatibility	Extension cable - 2.4 m
35220*	BCI	5	Pediatric finger	0.9 m		BCI: 3401, 3304, 3303, 3302, 3301, 3300; Spacelabs Burdick: PRO.; Draeger: Oxipac 2000/2500	35300
35221		1	Adult finger	0.9 m			-
35222		1	Adult finger	3.0 m			-
35225	CSI (Criticare)	6	Neonatal Y-type	3.0 m		Alaris (IVAC): VitalCheck 4400; Criticare: 503DX, 503 Spot, 504DX/P, 504DX, 506 series (except 506LN3), 507ELC2, 8100 Poet Plus, Poet (602-3A), Scholar, Scholar III	-
35226		1	Adult finger	0.9 m			-
35227		1	Adult finger	3.0 m			-
35230*	Datascope	1	Adult finger	0.9 m		Accusat, Accutorr 3/4 SAT, Accutorr Plus, Passport (Database SpO ₂)	35301
35231		1	Adult finger	3.0 m			-
35232*	Datex-Ohmeda	1	Adult finger	0.9 m		Datex-Ohmeda: AS/3, CS/3, CH/5, CH/25, CH-RS, SAF-F, CG/25, Cardiocap I, Cardiocap II, Cardiocap 5, Capnomac Ultima, Light Monitor, M-Estpr, Oscar II, OSP-200, Satlite Trans, Satlite, Trans Plus, System 5, ULT500	35302
35233		5	Pediatric finger	3.0 m			-
35234		1	Adult finger	3.0 m			-
35235		3	Adult Y-type ear sensor	3.0 m			-
35238	GE Datex-Ohmeda	1	Adult finger	3.0 m		GE (Datex-Ohmeda): S/5, i4 Modular Monitors with Eseries modules, Corometrics® 259 with TruSignal Ohmeda Technology	-
35239		2	Adult finger	4.0 m			-
35240		3	Adult soft-finger	3.0 m			-
35241		1	Adult Y-type ear	3.0 m			-
35243		1	Adult finger	3.0 m		Ohmeda TruSat Ohmeda TruSat TD	-
35245	GE	1	Adult finger	3.0 m		GE: Dash 2000/3000/4000 with Nellcor option, Dash 3000/4000/5000 with Ohmeda option, Solar 8000/8000M, i9500 with Tram Module 451/451N/851/851N, CardioLab®/Mac-Lab® with Tram Module 451/451N/Corometrics® 120/2120 series, Eagle 1000/3000/4000 Responder 3000 with Nellcor option	-
35247*	GE TruSignal	1	Adult finger	0.9 m		TruSignal sensors and interconnect cables are backwards compatible with Datex, ohmeda and GE SpO ₂ technologies.	35303
35250	Goldway	1	Adult finger	3.0 m		Goldway: UT4000 A / 4000 A pro / 4000B, UT6000 C	-
35252	Mindray	1	Adult finger	3.0 m		PM-600, PM-5000, PM-6000, PM-7000, PM-8000, PM-9000, MEC-1000 (Nellcor based) PM-50	-
35255**	Nellcor	6	Neonatal Y-type	0.9 m		Artema: Diascope, Datascope: (Mindray): Accutorr Plus, Expert, Passport, PM-50; Drager: Cicero, Narkomed, Vitalert 1000, GE Medical: Corometrics 118, 120, 129, 188, 510, 556, Critikon 9710, 9720, Plus, Compact, Dinamap Select, MPS, Oxyshtuttle, Pro 300/400, Eagle Series, Dash Series, Hellige Eagle, 1000, 3000, Eagle SMK, SMU, SMV, SOLAR Series, TRAM Modular x505L Series; Invivo Research: MI2 (Nellcor SpO ₂), Millennia 4500 Plus 2, Invivo/MDE Escort 100 OPT11A Escort 300A, Escort II OPT30, Prism (Nellcor SpO ₂); Ivy Biomedical: 405A, 4050, 405P, 405T, Vital-Guard 450 CN, Mennen: Horizon XL (Nellcor SpO ₂), MR 1300 Mercury 1200; Nellcor: N100 (req. preamp cable), N180, N200 (req. preamp cable), N-20, NPB-75, NPB-290, NPB-295, N-390, N-395, N-3000, N6000; Nihon Kohden: BSM-1102 Life Scope EC, BSM2304 iPro (Life Scope I), BSM-4102, 4112 Procyon LT (Life Scope P), BSM-4104, 4114 Procyon (Life Scope P), BSM-9510 Life Scope M (Nellcor SpO ₂), OGS2000 PocketCare (Nellcor SpO ₂); Pace Tech Vitalmax 800 Series (cara negra Nellcor SpO ₂); Philips 78352C, 78354C, 78834C, M1020A, M1025B, M1205A, M1350B, M1 722A/B, M1732A/B, M2475B, M2601A, M3000A	35304
35256**		5	Pediatric finger	0.9 m			35304
35257**		4	Adult/neonatal wrap	0.9 m			35304
35258**		1	Adult finger	0.9 m			35304
35259**		1	Adult finger	3.0 m			35304
35260**		2	Adult soft-finger	0.9 m			35304
35261**	3	Adult Y-type ear	3.0 m	35304			
35262**	Nellcor Oxitech	1	Adult finger	0.9 m		Nellcor Oximax: N-550, N-560, N-595, N-600 and Patient monitors with Oximax module	35305
35263**		2	Adult soft finger	0.9 m			-
35265**		4	Adult/neonatal wrap	0.9 m			-
35264	Nihon-Kohden	1	Adult finger	3.0 m		Nihon Kohden: BSM-4101, 4103 4111, 4113 Life scope P BSM-5105, 5135 Life scope A BSM-2351, 2353 Life scope L BSM-2301, 2303 Life scope I, Life scope S	-
35266**	Nonin	1	Adult finger	0.9 m		NONIN: 8500, 8600, 8700, 8800/9840 NONIN: 2500, 9600, 9700	-
35268	Novamatrix	6	Neonatal Y-type	3.0 m		Novamatrix: 505, 510, 511, 515B/C, 520, 7000, 7100; Oxyleth	-
35269		1	Adult finger	3.0 m			-
35272	Ohmeda	1	Adult finger	3.0 m		Datex-Ohmeda: 3740, 3710, 4700 OxiCap, 520RGM, Biox 3760, Ohmeda 3700, 3770, 3775, Rascal II, GE Medical System: 7000 series, Corometrics 511, TRAM A.R., Tram Modular x005L Series, Mennen: Horizon XL800 (Ohmeda SpO ₂)	-
35275	Philips	6	Neonatal Y-type	1.6 m		Philips: M3, M4, MP20, MP30, MP40, MP50, MP70, MP80, VM4, VM6, VM8	-
35276		4	Adult/neonatal wrap	1.6 m			-
35277		1	Adult finger	1.6 m			-
35278		1	Adult finger	3.0 m			-
35279		2	Adult soft-finger	1.6 m			-
35280		2	Adult soft-finger	3.0 m			-
35281	3	Adult Y-type ear	3.0 m	-			
35283		2	Adult soft-finger	3.0 m		Philips: 1205, M1205A, 78352C, 78834C, 78354C, M1020A, M1025A, M1025B, M1350B, M1772A/B, M1732A/B, M2475B	-
35285	Siemens/Drager	1	Adult finger	1.6 m		Siemens/Drager: SC6002XL, 7000, SC8000, SC9000XL	-
35286		2	Adult soft-finger	1.6 m			-
35287		3	Adult Y-type ear	1.6 m			-

*These SpO₂ sensors need extension cable for connection to device.

** Available extension cable.

All products are supplied with manual in GB, FR, IT, ES.

CAPNOGRAPH AND OXIMETER

33698 CAPNOGRAPH AND OXIMETER PC-900B

This innovative and handheld capnograph and oximeter is ideal for monitoring the most severe conditions of patients. It provides reliable SpO₂ and pulse rate measurements thanks to its unique MoveOxy™ technology specially conceived for SpO₂. It offers an accurate monitoring even in weak pulse signals condition and reliable monitoring in movement. Display of graphical trends and plethysmographic waveform.

- 3.5" TFT display showing EtCO₂, RR and SpO₂, PR
- lung pressure and temperature compensation (BTPS compensation)

- for intubated or non-intubated patients
- graphic trend storage up to 24 hours
- USB cable to transfer data on PC
- wireless module to connect to Bluetooth printer

Internal languages: GB, IT, ES, NL

Water filter, sampling line and airway adapter must be changed anytime you use it.

- 34351 ADULT SpO₂ RUBBER PROBE - reusable
- 34345 ADULT SpO₂ CLIP PROBE - reusable - spare
- 34347 PEDIATRIC SpO₂ PROBE - reusable
- 34349 NEONATAL SpO₂ Y PROBE - reusable
- 33699 WATER FILTER
- 33700 SAMPLING LINE
- 33701 AIRWAY ADAPTER
- 34172 NASAL CANNULAS



CE 0123

FDA 510(K)



PC software for data review and analysis
Software (GB only) can be freely downloaded



Wireless connection
Bluetooth printer

STANDARD ACCESSORIES

- | | | |
|------------------------|--|---------------|
| 2 water filters | USB data cable | Support base |
| 2 sampling lines | Nasal CO ₂ sampling cannula | Manual GB, IT |
| 2 airway adaptors | Silicone protective case | |
| SpO ₂ probe | Carrying bag | |



TECHNICAL SPECIFICATIONS

EtCO₂
EtCO₂/CO₂ range: 0-150 mmHg (0-20 kPa, or 0-20% (V/V))
Accuracy: ±2 mmHg when 0-40 mmHg
±5% (reading) when > 41-70 mmHg
±8% (reading) when > 71-100 mmHg
±10% (reading) when > 101-150 mmHg
Update: Every breathing, 10, 20 or 30 sec selectable
Trend length: 24 hours
Respiration rate
Range: 3-150 breaths/min
Accuracy: ±1% (reading) or ±1 times/min whichever is greater
Trend length: 24 hours
Flux: 50-250 cc/min selectable

SpO₂
Oximetry saturation range: 0-100%
Accuracy: ±2% when 70-100%, ±3% when 50-69%
Trend length: 24 hours
Pulse rate
Range: 30-250 bpm
Accuracy: ±2 bpm or ±2% (reading) when 30-250 bpm
Trend length: 24 hours
Power supply
AC input consumption: 100-250 V, 50-60 Hz, 5 W
Battery: Built-in rechargeable lithium battery - 3.6 V, 3000 mAh
Working time: 10 hours
Dimension - Weight: 70x160x44 mm - 600 g

OXY-200 DESKTOP PULSE OXIMETER

Continuous working time: more than 1 hour

Audible and visible alarm for over-limit and low battery.
Upper and lower alarm limit can be set.



35101

Screen brightness, volume and display mode can be adjusted

320x240 TFT screen and LCD

Menu operation easy to use

35101 OXY-200 DESKTOP PULSE OXIMETER with monitor and battery

Portable oximeter displays SpO₂, PR, bar graph, PI, pulse waveform and battery power. Multiuser data storage and review. Stored data can be uploaded to PC in real time. Finger adult probe, battery and software for PC download are included.

- 35102 LITHIUM RECHARGEABLE BATTERY - spare
- 35105 SpO₂ FINGER-PROBE - adult or child over 15 kg - spare
- 35106 PEDIATRIC PROBE 3-15 kg - reusable
- 35107 NEONATAL PROBE <3 kg - reusable - needs 35108
- 35109 ADULT NEONATAL PROBE* - disposable - needs 35108
- 35108 EXTENSION CABLE necessary for 35107, 35109

TECHNICAL SPECIFICATIONS

Power supply: 100-240 V, 50/60 Hz rechargeable lithium battery
SpO₂ measuring range: 0-100% ±2% (between 70-100%)
Pulse rate: 30-250 bpm ±2 bpm or ±2% (select larger)
PI measuring range: 0-20% ±1% (between 1%-20%)
Size: 269x222x79 mm - Weight: 1 kg
Resolution: 1%
Resolution: 1 bpm
Resolution: 0.1%
User manual (GB, IT)

*Suitable for adult over 40 kg (finger) or neonate less than 3 kg (foot)

ETCO₂ + SPO₂

Size: 170x88x44 mm

PORTABLE OXI-CAPNOGRAPHY MONITOR

- 33702 OXY CAPNOGR. HUMAN
- 33703 OXY CAPNOGR. VET

Portable multifunctional Capnography monitor providing SpO₂, Pulse, EtCO₂, Respiration with accuracy and reliable performance. Light and large LCD display providing graphical SpO₂, EtCO₂ and Trend function all in one design. Through optional software link to PC via USB. Filter replacement after 8 hours of use. Supplied with adult sensor, AC adapter, sampling tube, carrying bag, 4 AA rechargeable batteries.

72 hours memory with trend function

- 33705 FILTER - box of 10
- 33706 SAMPLING TUBE 1.2 m - box of 20
- 33708 VET PROBE - spare

TECHNICAL SPECIFICATIONS

SpO ₂ Saturation:	Range: 0% to 100%	Accuracy: ±2% between 80% to 100%
Pulse Rate:	30 bpm to 250 bpm	±1% of full scale
EtCO ₂ :	Range: 0 mmHg to 100 mmHg	Average: 4 breaths of EtCO ₂
Respiration rate:	0 l/min to 99 l/min	8 breaths of respiration rate
Memory: 72 hours		
Output interface: USB		
Default Alarm Settings:		
SpO ₂ upper limit: 100%		SpO ₂ lower limit: 50%
Pulse rate upper limit: 250 bpm		Pulse rate lower limit: 30 bpm
EtCO ₂ upper limit: 100 mmHg		EtCO ₂ lower limit: 0 mmHg
Resp upper limit: 99 l/min		Resp lower limit: 0 l/min
Power 4 AA rechargeable batteries 6 volts or AC/DC adapter		



OXY-50 HANDHELD PULSE OXIMETER



CE 0476
FDA K090671

Plethysmogram waveform

• **35100 OXY-50 PULSE OXIMETER** - with software Pocket fingertip pulse oximeter with colour display for both routine check and continuous monitoring use.

Main features:

- display: 1.8" colour OLED
- resolution: 160x128
- alarm sound, pulse tone
- power supply: DC3V, <100MA
- record: data can be recorded up to 24 hours
- alarm: adjustable high and low limits
- PC software for transferring real time data

code	ACCESSORIES OXY-50
35105	Adult probe >15 kg - reusable - spare
35106	Pediatric probe 3-15 kg - reusable
35107	Neonatal probe < 3 kg - reusable
35109	Adult neonatal probe* - disposable - 70 cm cable
35108	Extension cable necessary for 35107, 35109 - 2 m

*Suitable for adult over 40 kg (finger) or neonate less than 3 kg (foot)



Supplied with one adult probe, 2 AA batteries, USB cable, PC software (GB, IT, PL) and user manual (GB, FR, IT, ES)



TECHNICAL SPECIFICATIONS

Display mode (OLED display)

Pulse oxygen saturation (SpO₂): 2 digits
Pulse rate (PR): 3 digits
Pulse intensity: bar-graph

Pulse rate

Measuring range: 25 - 250bpm
Resolution: 1 bpm
Accuracy: ±2bpm or ±2%

SpO₂

Measuring range: 0 - 100%, (resolution 1%)
Accuracy: 70 - 100%: ±2%
Average value: Calculate the average value every 4 measure value
Deviation between average value and true value does not exceed 1%

Average pulse rate:

Moving calculate the average pulse rate every 4 cardio-beat's cycle. Deviation between average value and true value does not exceed 1%

Pulse intensity Range:

Continuous bar-graph display, the higher display indicates the stronger pulse

Battery:

Oxymeter probe: dry battery (2AA)
Dimension: wavelength: 660 - 880nm
Weight: 110(L)x60(W)x23(H) mm about 180g (with dry battery 2AA)
Safe type: BF Type

OXY-100 HAND-HELD PULSE OXIMETER

• 34342 OXY-100 PULSE OXIMETER

Compact pulse oximeter for hospital and rescue applications to monitor SpO₂ pulse rate, and perfusion index (PI). SpO₂ can be displayed in numbers with bar-graph of pulse as well as full display of plethysmogram.

Includes adult SpO₂ sensor and extension cable.

Features:

- high accuracy and repeatability
- visual and audible alarm, with adjustable limits
- 384-hours data storage and review (with 1/2/4/8 sec.)

- automatic power-off
Manual: GB, FR, IT, ES, PT.

• 34344 SOFTWARE

This software allows to download and store all measurements on a PC through USB port.

- 34345 ADULT SpO₂ CLIP PROBE - reusable - spare
 - 34351 ADULT SpO₂ RUBBER PROBE - reusable
 - 34347 PEDIATRIC SpO₂ PROBE - reusable
 - 34348 EXTENSION CABLE - spare for 34345-34347-34349-34351 - 1 m
 - 34349 NEONATAL SpO₂ Y-TYPE PROBE - reusable
- All probes with cable 0.9 m

3 ways switchable display to show: numbers, number and waveform, waveform

Battery status display

TECHNICAL SPECIFICATIONS

Oxygen saturation range: 35% to 100%
Pulse rate range: 30 bpm to 240 bpm
Perfusion index (PI) range: 0.2% to 20%
Display: oxygen saturation, pulse rate, pulse strength, low battery indicator, perfusion index
SpO₂ accuracy: not greater than 3% for SpO₂ range from 70% to 100%
Accuracy defined as root-mean-square value of derivation according to ISO 9919
Pulse accuracy: ± 2% of full scale
Range alarm setting: SpO₂ upper limit: 95%
SpO₂ lower limit: 85%
pulse rate upper limit 100 - 240 bpm
pulse rate lower limit 30 - 60 bpm
Power requirements: 3 alkaline AA size batteries 4.5 V
continuous working time >30 hours
Dimensions: 145x74x29 mm - Weight: 210 g
Warranty: 1 year



Output for USB

High resolution LCD display, backlight to display SpO₂, PR, Pulse Bar, Pi, and Plethysmogram



34342



Portable and lightweight

CE 0476



MINDRAY PM-60 PULSE OXIMETER



Size: 55x120x30 mm
Weight 300 g with battery

• **35060 MINDRAY PM-60 PULSE OXIMETER**
PM-60 is a miniature, lightweight device capable of **spot-check and continuous monitoring of SpO₂ and pulse rate.**

Spot Check Mode

- auto-standby and power off during the idle status
- auto-increase the patients IDs
- non-alarm setting for "sensor off" occasion

Continuous monitoring mode

- regular alarm handing
- enable to input patient ID manually
- view SpO₂ waveform for maximum 96 hours trend

Other features

- suitable for adult and pediatric patients
- high resolution 2.4" colour LCD display
- adjustable visual and audible alarms
- real-time data transfer by infrared technology
- choose between Lithium-ion or AA alkaline batteries (for up to 36 hours continuous working) depending on your run-time needs

Supplied with adult reusable sensor

- **35062 PROTECTIVE COVER - light blue**
- **35063 DATA MANAGEMENT KIT**
- **35064 BATTERY CHARGING KIT (EU)**
- **35065 PEDIATRIC REUSABLE SENSOR**

35060
+
35062



TECHNICAL SPECIFICATIONS	
Performance specifications	
Display:	2.4" colour TFT Resolution: 320x240
Multi displays selectable:	standard or waveform screen
Trace:	1 plethysmogram waveform
Indicator:	alarm indicator light, power indicator light, pulse tone, alarm sound, button tones
Interface:	dual-purpose socket for connecting SpO ₂ sensor and communication cable
IR interface:	infrared link allows downloading realtime patient data to computer
DC power interface:	Charger stand for Li-ion battery
DC power requirements:	input voltage 5V DC Power 1.2A
Battery:	Li-ion battery 24 hours continuous working 3xAA batteries 36 hours continuous working
Trend memory:	Monitoring mode: Resolution: 2s Spot-check mode: Maximum time: 96 h Review of up to 4,000 data Measure up to 99 patients
Alarm:	user adjustable high and low limits 3-level audible and visual alarm
SpO₂	
Measurement range:	0-100% ±2% (70-100%)
Resolution:	1% Alarm range: 50-100%
Refreshing rate:	1 s
Averaging time:	7 s (sensitivity set HIGH) 9 s (sensitivity set MED) 11 s (sensitivity set LOW)
Pulse rate	
Range:	18-300 bpm (±3 bpm non-motion) (±5 bpm motion)
Resolution:	1 bpm Alarm range: 18-300 bpm
Refreshing rate:	1 s
Averaging time:	same as SpO ₂
Type of protection:	Class II with internal electric power supply
Degree of protection:	BF (defibrillation proof)
Protection against ingress of liquid:	IPX 2

COMDEK HOSPITAL PULSE OXIMETERS

- **34290 MD-600 PULSE OXIMETER with alarms**
- **34291 MD-630 PLUS PULSE OXIMETER with alarms, printer and USB**

Light-weight pulse oximeters with high accuracy and reliable performances:
- adjustable SpO₂ and pulse alarm settings
- quick assessment of oxygen saturation and pulse rate
- with SpO₂ and pulse rate display

Pulse oximeter with printer and USB (34291 only)

Built-in thermal printer allows immediate data printing.
36 hours memory (with interval of 6 seconds) or 24 hours (with interval of 4 seconds) with possibility to recall up to 100 records (print out the last records up to 240 seconds).

Tone function and adjustable volume.

- **34295 THERMAL PAPER - for code 34291**
- **33704 PC-SMART LINK SOFTWARE - for code 34291**
- **34292 ADULT FINGER SENSOR over 40 kg - reusable**
- **34294 CHILD TOE SENSOR 3-15 kg - reusable - need 34299**
- **34299 EXTENSION CABLE for 34294**

TECHNICAL SPECIFICATIONS (codes 34290-34291)

Oxygen saturation range:	0% to 100% ± 2% between 80% to 100%; ± 3% between 65% to 79%
Pulse rate range:	30 bpm to 250 bpm ± 1% of full scale
Display:	oxygen saturation, pulse rate, pulse search indicator, low battery indicator
Range alarm setting:	SpO ₂ upper limit: 100%, lower limit: 50%; pulse rate upper limit 250 bpm, lower limit 30 bpm
Power requirements:	DC 6 volts by 4 alkaline AA size batteries AC adapter output DC 6 Volts, 600 mA
Dimensions - weight:	172x90x36 mm (34290) - 170x88x44 mm (34291) - 240 g - 300 g (34291) - without battery

34290



STANDARD ACCESSORIES (codes 34290-34291)

- 1 AC/DC Adaptor
- 1 SpO₂ standard adult sensor
- 4 AA Batteries - alkaline
- 1 User manual (GB, IT, FR, ES)
- 1 Carrying bag



OXY 110 PULSE-OXIMETER FOR NEONATES, CHILDREN AND ADULTS

- **34341 OXY 110 PULSE OXIMETER**
- large 3.5 inch auto rotation TFT display for SpO₂, PI, Plethysmogram, PR and temperature
- patented MoveOxy™ SpO₂ technology with artifact removal and anti-motion performance
- various choice of SpO₂ probes for adult, pediatric and neonate
- in-built lithium battery up to **20 hours continuous monitoring**
- adjustable alarm limit, pitch tone level, key tone and brightness
- up to 1,000 hours SpO₂ data storage
- upgradeable to infrared ear temperature

Supplied with adult probe, charging base, USB cable.

- **34345 ADULT SpO₂ CLIP PROBE - reusable - cable 0.9 m - spare**
- **34351 ADULT SpO₂ RUBBER PROBE - reusable - cable 0.9 m**
- **34347 PEDIATRIC SpO₂ PROBE - reusable - cable 0.9 m**
- **34349 NEONATAL SpO₂ Y-TYPE PROBE - reusable - cable 0.9 m**
- **35170 EAR INFRARED THERMOMETER**
- **35171 EAR PROBE COVER for 35170 - box of 500**
- **34344 SOFTWARE for download and store**

TECHNICAL SPECIFICATIONS

Technique:	dual wavelength LED
Oxygen saturation range:	35 to 100% ±3%
Pulse rate range:	30 to 250 bpm ±2%
Perfusion index (PI) range:	0.2 to 20%
Display:	3.5" TFT display
Data storage:	up to 1,000 hours
Measuring mode:	continuous or spot check
Power supply:	lithium battery
Charging:	charging stand or USB cable
Dimension:	158x73x25 mm
Weight:	240 g
Data upload:	USB cable or wireless

34341



34341

OXY-5 AND OXY-6 PROFESSIONAL OXIMETERS



34282



34285



34285

- 34282 OXY-5 FINGERTIP OXIMETER
 - 34265 OXY-5 PEDIATRIC FINGERTIP OXIMETER
 - 34285 OXY-6 COLOUR FINGERTIP OXIMETER
- To monitor pulse oxygen saturation and pulse rate through patient's finger (10-22 mm finger thickness for 34282, 34285 - 8-16 mm finger thickness for 34265) in medical and hospital environments.

Main features:

- SpO₂ and pulse rate measurement
- bargraph of pulse rate
- perfusion index display. P.I. is a numerical value that indicates the blood perfusion condition at the sensor site. It is a relative value that varies from patient to patient and from measuring site
- high accuracy and repeatability: products are manufactured by GIMA (in P.R.C. facilities) under strong quality controls guaranteed by Italian notified body (CE 0476 CERMET)
- accuracy from the first reading in few seconds thanks to a unique noise rejection capability feature
- extra stability against motion during measurement (finger bending, Parkinson's disease, hand movement, button pressing)

- audible and visible alarms
- automatic power on and power off when finger is out
- low voltage alarm display
- 8 or 9 language manual (GB, FR, IT, ES, DE GR, PT, PL, Arabic)
- 50 hours working time with full batteries (30 hours for oxy-6)
- supplied in plastic case with batteries and pouch
- 4 direction adjustable display (Oxy-6 only)

• 35076 CORDURA BAG with belt loop - blue *34265, 34282 only

TECHNICAL SPECIFICATIONS			
	RANGE	ACCURACY	RESOLUTION
Pulse rate:	30-240 bpm	± 2 bpm (2%)	1bpm
SpO ₂ :	35%-99%	± 2% (75-99%) ± 3% (50-75%)	1%
Perfusion Index:	0-20%	± 0.1% (0.2-2%) ± 0.2% (2-10%)	0.1%
Alarm:	SpO ₂ : low limit 90% Pulse rate: low: < 50 bpm - high > 120 bpm		
Power:	1.5V (AAA size) alkaline battery x 2		
Norms:	IEC 60601-1-2 Class II CE 0476		
LCD Display:	oxygen saturation, pulse rate, low battery indicator		
Size - weight:	6.6x3.6x3.3 cm - 60 g including batteries		
Italian manufacturer (made in P.R.C.)			

OXY-3 OXIMETER



35090

- 35090 OXY-3 OXIMETER - blister
- Easy to use pocket device, measures oxygen level and pulse rate.

Main features:

- simple operation, small & lightweight design, portable
- display SpO₂, SpO₂ waveform, PR, Pulse bar
- low power consumption
- 2 AAA alkaline batteries included
- low battery indication, auto power off
- accommodates widest range of finger sizes from pediatric to adult
- soft silicone padding, strong slip
- resistant clip, non-invasive, no pricking
- 4 direction display
- user manual in GB, IT, ES, FR

- 35075 SILICONE COVER - light blue
- 35076 CORDURA BAG with belt loop - blue



Supplied in blister with batteries and lanyard.

35090



35076

OXY-4 COLOUR OXIMETER



35091

35092

CE 0123

- 35091 OXY-4 OXIMETER - blue
- 35092 OXY-4 OXIMETER - orange
- 35093 OXY-4 OXIMETER - other colour (minimum 100 pieces)

Select colour with order

1 2 3 4 5 6

- Fingertip pulse oximeter to monitor pulse oxygen saturation, pulse rate, and perfusion index.
- it is light, small in size and easy to take
 - accurately measures SpO₂ value and pulse rate value
 - dual-color display of SpO₂, PR, PI, Plethysmogram and pulse bar
 - measuring range, SpO₂ 35 - 99%, Pulse rate 30 - 240 bpm
 - innovative 4 directions display
 - automatic power On/Off
 - more than 30 hours continuous working with 2AAA alkaline batteries
 - audible and visible alarm function
 - battery voltage indication, low battery voltage alarm
 - prevention against water ingress, drop resistant
 - manual in 8 languages: GB, FR, IT, DE, ES, PT, GR, PL
 - 35076 CORDURA BAG with belt loop - blue

NONIN GO2 OXIMETER



Back light display
2400 tests performed with one AAA battery (21 hours continued use)



CE 0123

Lead (PB) free and latex free

- 35079 NONIN GO2 - 9570 - IT, FR, DE, NL
- 35080 NONIN GO2 - 9570 - GB, FR, ES, PT

GO2 are manufactured to the same technical specifications and technology used in NONIN professional

oximeters, but are dedicated to consumers for people suffering from shortness of breath, fatigue or limited activities.

- highly resistant: it is tested to resist 25 times to fall down from 1 meter, to liquids and to continuative use
- patient oriented display
- finger size range from pediatrics to adult
- easy to read perfusion indicator
- suitable for low perfusion patient

Other manuals for download: GR, PL, DK, NO, SE, FI.

TECHNICAL SPECIFICATIONS

Saturation range: 0-100% ± 2 digit (70-100%)
Pulse rate range: 18-321 bpm ± 3 digit (20-250 bpm)

OXY-PED

4 direction OLED colour display



PEDIATRIC

Visual and audible alarms

• 34266 OXY-PED PEDIATRIC OXIMETER
Similar to OXY-6 but suitable for pediatric use. Input shaped to fit children's fingers thickness 8-16 mm. It is supplied with two rechargeable batteries and USB battery recharger. All other specifications are like OXY-6 model.

- 34270 RECHARGEABLE BATTERY - spare



TECHNICAL SPECIFICATIONS

	RANGE	ACCURACY	RESOLUTION
Pulse rate:	30-240 bpm	± 2 bpm (2%)	1bpm
SpO ₂ :	35%-99%	$\pm 2\%$ (75-99%) $\pm 3\%$ (50-75%)	1%
Perfusion index:	0-20%	$\pm 0.1\%$ (0.2-2%) $\pm 0.2\%$ (2-10%)	0.1%

Alarm: SpO₂: low limit 90%
Pulse rate: low: < 50 bpm - high > 120 bpm
Power: 3.6V rechargeable batteries
Norms: IEC 60601-1-2 Class II

NONIN ONYX® VANTAGE 9590



Large Bright LED Display
SpO₂ and pulse rate can be read from any angle, day or night



The original all-in one digital fingertip pulse oximeter™

Lead (PB) free and latex free



CE 0123

- 35085 NONIN ONYX® VANTAGE 9590 PULSE OXIMETER

The Onyx is the only finger pulse oximeter with scientifically proven accuracy in motion and low perfusion, and it is tested for use on fingers, thumbs, or toes.

- Accurate - Scientifically proven performance in the widest range of patient populations and settings
- Durable - Protects against dropping and water spills; allows for thousands of uses in the most demanding environments and exceed IP32 water ingress testing
- Efficient - Up to 6000 spot checks or 36 hours of continual operation on two AAA batteries
- Safe - Built in the USA with lead-free and latex-free construction
- Versatile - One unit works on the widest range of patients from pediatric to larger adult patients. Accommodates a wide range of digit thicknesses from 8 mm to 25.4 mm
- Warranted - Industry-leading 4-year warranty
- Cost Effective - Proven accuracy, quality and durability make the Onyx Vantage a smart purchase for the long term

Supplied with multilanguage CD-ROM manual: GB, FR, IT, DE, ES, PT, GR, NL, PL, NO, FI, DK, SE.

TECHNICAL SPECIFICATIONS

Pulse rate range:	18-321 bpm	± 3 digit (20-250 bpm)
SpO ₂ range:	0-100%	± 2 digit (70-100%)
Low perfusion SpO ₂ :	70-100%	± 2 digit
Low perfusion pulse rate:	40-240 bpm	± 3 digit

OXY-10 OXIMETER - WIRELESS



OLED COLOUR DISPLAY

- 35095 OXY-10 FINGERTIP MULTIFUNCTION OXIMETER

Professional oximeter to monitor pulse oxygen saturation and pulse rate through patient's finger (adult, child, neonate).

- wireless Bluetooth technology for transmission to PC Windows (XP and Seven) and Android (need APP). Software for data management
- external pediatric SpO₂ probes available in 4 sizes for pediatric and neonatal use
- large true colour OLED display
- SpO₂, PR, Pulse bar, P.I. and plethysmogram
- accuracy from the first reading in a few seconds
- extra stability against motion during measurement
- audible and visible alarms with high and low alarm limits adjustable by user

CE 0476

- patient oriented display with automatic change of 4 directions
- 9 languages manual (GB, FR, IT, DE, ES, GR, PT, PL, Arabic)
- Communication protocols on request
- Supplied in nylon bag with batteries

- 35096 PEDIATRIC CLIP PROBE - reusable
- 35097 PEDIATRIC RUBBER PROBE - reusable
- 35094 NEONATAL PROBE KIT - reusable probe + 20 disposable wraps
- 35099 NEONATAL Y-PROBE - reusable

TECHNICAL SPECIFICATIONS

	RANGE	ACCURACY
Pulse rate:	30-240 bpm	± 2 bpm or 2%
SpO ₂ :	70%-100%	$\pm 3\%$
Perfusion index (PI):	0.2-20%	
Alarm: SpO ₂ :	85-99%	
Pulse rate:	high 100-240 bpm low 30-60 bpm	
Power:	2xLR03 (AAA) Alkaline batteries 3.0 VDC	
Size:	60x33x30 mm	Weight: 35 g

EXTERNAL PEDIATRIC - NEONATAL PROBES



Neonatal reusable probe with disposable wrap

35094

Neonatal reusable probe

35099

Pediatric clip reusable probe

35096

Pediatric rubber reusable probe

35097

External pediatric SpO₂ probe with 1 m cable

35096

IPAD CU-SP1 INTELLIGENT PUBLIC ACCESS DEFIBRILLATOR

CU-SP1 is the last generation of intelligent public access defibrillators with innovative features:

- Auto volume adjustment

It detects the ambient noise and automatically adjusts the volume of its prompts to make them audible over the background noise.

- Smart pads - intelligent storage

The pre-connected "Smart" electrode pads are stored in an easy access compartment on the underside of the unit. This ensures that the iPad SP1 is always ready to be used in the shortest time possible. In addition, the visual frontal indicator shows if the connected pads are within their life expectancy. The indicator will change when the pads have only 3 months life left before their expiry date giving you time to arrange for replacements. It will change again when the expiry date is reached.

- CPR detection

CPR ensures that the casualty has the best chances of survival. The CU-SP1 detects if CPR is being performed with appropriate prompts, if not it encourages the responder to perform it.

- Easy communication with CU-EX1 software

Installing CU-EX1 software onto a computer allows you to see and analyze the usage history of the unit. Information such as time of "power on", the casualty's heart rhythm and shocks delivered are all clearly presented.

The iPad CU-SP1 can store up to 5 events with up to 3 hours of ECG analysis on an SD memory card.

- 16 languages available (to be indicated with order)

Selectable software languages: US, GB, FR, IT, ES, DE, PT, NL, PL, SE, DK, NO, CZ, GR, AE, KR, IL. On request LT.

Supplied with adult SAVE PADS, carrying bag, disposable lithium battery pack, paper manual (GB, IT) and CD manual in above languages excluding PL and GR.



Automatic defibrillator without shock button

35339



35340

TECHNICAL SPECIFICATIONS

Defibrillator	
Operating mode:	Semi-automatic
Waveform:	e-cube biphasic (Truncated exponential type)
Energy:	150J fixed Adult: nominal 150J at 50 ohm load Infant/child: nominal 50 joules at 50 ohm
Charge control:	controlled by automated patient analysis system
Charging time:	within 10 seconds since voice instruction "an electric shock is needed"
Sealing:	waterjet proof IPX5 per IEC60529 (IP55) dust protected IP5X per IEC60529
User interface	
User support:	detailed voice prompts and flashing indicators
CPR guidance:	voice prompts for how to perform CPR for adult and child
Controls:	on/off button, "i" button, shock button (only 35340)
Indicator:	LCD display (Device status, Battery status, Pads status)
Sensing:	pads expiry date, Pads connection status
CPR Monitoring	
Automatic Volume adjustment	
Data recording and transmission	
IrDA port:	wireless transmission of event data to PC, SD Card
Internal Memory (Nand-flash):	ECG, Event
Storage capacity:	multi recording 5 events / Max 3 hours
Data review PC Programme:	CU-EX1
Patient analysis system	
Patient Analysis:	Shockable Rhythms - Ventricular Fibrillation, Tachycardia
Sensitivity/Specificity	Meets AAMI DF80 Guideline
Disposable high capacity battery	
Standard	Type: DC 12 Volt 4.2 Ah, Lithium manganese dioxide Capacity: Minimum 200 shocks (150J)

code	IPAD CU-SP1 AED DEFIBRILLATOR
35340	iPad CU-SP1 defibrillator - semiautomatic
35339	iPad CU-SP1 defibrillator - automatic
ACCESSORIES FOR CU-SP1	
35342	Trainer Defi Pads - kit of 2
35343	Trainer - 16 selectable software languages
35344	Adult PADS - kit of 2 pcs - disposable
35345	Pediatric PADS - kit of 2 pcs - disposable
35346	Disposable lithium battery LiMnO ₂ high capacity 4.2 Ah
33423	Wall cabinet with sound alarm
35349	SD card+ software for event recording download

METAL CABINETS FOR DEFIBRILLATORS - INDOOR OR OUTDOOR

METAL CABINETS FOR DEFIBRILLATORS - INDOOR USE

- 35330 METAL CABINET - INDOOR USE - white
- 35331 METAL CABINET WITH ALARM - INDOOR USE - white
Door with opening at 180° with transparent acrylic window. Suitable for wall mounting or use with pole. Horn alarm at 100 dB (only 35331)
- 35333 POLE for cabinet - white

METAL CABINETS FOR DEFIBRILLATORS - OUTDOOR USE

- 35334 METAL CABINET - OUTDOOR USE - yellow
Water tight welding on the sides, water and dust proof gaskets. Made in carbon steel, thickness 15/10. Adjustable internal shelf. Door with transparent acrylic window.
- 35335 METAL CABINET WITH THERMO REGULATION SYSTEM AND ALARM - OUTDOOR USE - yellow
Same as 35334, with antitheft magnetic sensor that activates a 100 dB siren in case of non authorized withdrawal. 9V alkaline battery for alarm. Low charger indicator. Power 230V for thermoregulation. Suitable for wall mounting or use with pole.
- 35337 POLE for cabinet - yellow

INDOOR USE



External size: 42.5x16xh 42.5 cm
Internal size: 40x13xh 40 cm

OUTDOOR USE



External size: 43x21xh 48 cm
Internal size: 42x20xh 45 cm

IP 44 PROTECTION

IPAD CU-SP2 AED MODE DEFIBRILLATOR

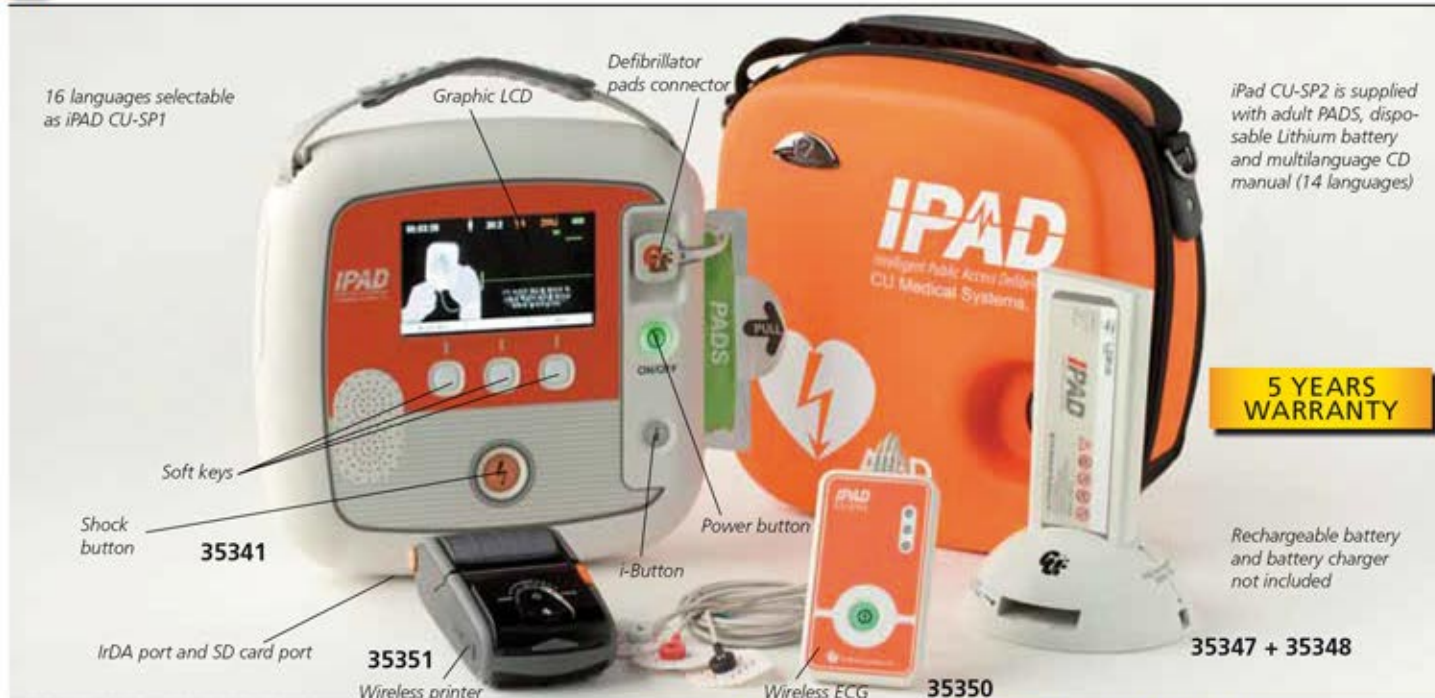

• 35341 IPAD CU-SP2 DEFIBRILLATOR - AED MODE

CU-SP2 is the last generation of intelligent public access defibrillators with innovative features:

- Auto volume adjustment

It detects the ambient noise and automatically adjusts the volume of its prompts to make them audible over the background noise.

- Smart pads - intelligent storage

The pre-connected "Smart" electrode pads are stored in an easy access compartment on the underside of the unit ensuring use in the shortest possible time. In addition, the visual frontal indicator shows if the connected pads are within their life expectancy. The indicator will change when the pads have only 3 months life left before their expiry date giving you time to arrange for replacements. It will change again when the expiry date is reached.

- CPR detection

CPR is vital to ensure that the casualty has the best chances of survival. iPad CU-SP2 detects if CPR is being performed with appropriate prompts, if not it encourages the responder to perform it.

- Easy communication with CU-EX1 software

It allows to see and analyze information such as time of "power on", the casualty's heart rhythm and shocks delivered. It saves 3 events on the internal memory (up to 17 hours per event).

- Wireless ECG transmission device (CU-EM1) - optional

In monitor mode, iPad CU-SP2 uses Bluetooth to receive ECG data from CU-EM1 and displays it on the LCD screen.

- Printer - optional

iPAD CU-SP2 supports connection to an external Bluetooth printer.

- 16 languages available

Selectable software languages: GB, FR, IT, ES, DE, PT, NL, SE, PL, FI, DK, NO, CZ, GR, UA, KR.

Supplied with adult SAVE PADS, carrying bag, disposable Li-ion battery pack, paper manual (GB, IT) and CD manual in above languages excluding PL and GR. Warranty 5 years.

TECHNICAL SPECIFICATIONS

Defibrillator	
Operating mode:	Semi-automatic
Waveform:	e-cube biphasic (Truncated exponential type)
Energy:	AED mode: 150/200J fixed or 150-150-200J energy escalating Manual mode: 2-200J, R-Sync
Charging time:	within 10 seconds
Charging time after CPR finished:	at least 6 seconds
Sealing:	waterjet proof IPX5 per IEC60529 (IP55) dust protected IP5X per IEC60529
User interface	
User support:	detailed voice and text prompts
CPR guidance:	voice prompts for how to perform CPR for adult and child
Controls:	on/off button, "i" button, shock button, soft keys
Indicator:	graphic LCD display (status, user's guide, ECG, heart rate,)
Sensing:	pads expiry date, pads connection status
CPR Monitoring, ECG Monitoring, Automatic Volume adjustment	
Data recording and transmission	
IrDA port:	wireless transmission of event data to PC, SD Card
Internal Memory (Nand-flash):	ECG, Event
Storage capacity:	multi recording 3 events / Max 17 hours for each event
Bluetooth:	communication with the printer
Data review PC Programme:	CU-EX1
Patient analysis system	
Patient Analysis:	Shockable Rhythms (Ventricular Fibrillation, Tachycardia)
Sensitivity/Specificity	meets AAMI DF80 Guideline
Battery	
Rechargeable battery Type:	DC 11.1 Volt 1.9 Ah, Li-ion rechargeable
Capacity:	Minimum 60 shocks or 3 hours of operation
Standard Type:	DC 12 Volt 4.2 Ah, Lithium manganese dioxide
Capacity:	Minimum 200 shocks (150J)

code	ACCESSORIES FOR CU-SP2
35344	Adult PADS - kit of 2 pcs - disposable
35345	Pediatric PADS - kit of 2 pcs - disposable
35346	Disposable Lithium battery LiMnO ₂ high capacity 4.2 Ah - spare
35347	Rechargeable 12 V, 1.9 Ah Li-ion battery - optional
35348	Battery charge dock + battery charger for 35347
35349	SD card+ software for event recording download
35350	Wireless ECG for CU-SP2
35351	Wireless printer for CU-SP2

COMPATIBLE DEFIBRILLATOR ECG THERMAL PAPER - DIFFERENT BRANDS

code	MANUFACTURER AND MODEL	Type	Width mm	Length m	Sheet	Marker	Grid*	Min. order
33100	CORPLUS Corplus 3	roll	106	20	-	no	or/red	10
32968	MINDRAY Beneheart D3, D6	roll	50	20	-	no	or/red	20
33103	HEWLETT PACKARD 40457C/D, Codemaster 100, XL	roll	50	30	-	no	or/red	20
33029	NIHON KOHDEN Def. TEC 5521, 5531, BSM 2300, 3000	pack	50	100	200	no	or/red	25
32988	Tech-8300	roll	50	30	-	no	or/red	20

*or/red: grid could be orange or red colour

GIMA code	MANUFACTURER AND MODEL	Type	Width mm	Length m	Sheet	Marker	Grid*	Min. order
33102	PHILIPS Defibrillator MRX	roll	75	25	-	no	or/red	10
33103	Heartstart XL	roll	50	30	-	no	or/red	20
33032	PHYSIO CONTROL Life Pack 8-9-10	roll	50	23	-	no	or/red	20
33033	Life Pack 11-12-15	roll	107	25	-	no	or/red	10
32983	SCHILLER Defigard 6002	pack	80	70	300	yes	or/red	20
33106	ZOLL Defi/1400 (P/N 8000-0300)	pack	90	90	200	yes	or/red	20

5 YEARS WARRANTY
in standby mode*

*If used during 5 years battery should be replaced

i-PAD NF 1200 PUBLIC ACCESS DEFIBRILLATOR

Semi-automatic external defibrillator designed for minimally trained individuals. It provides simple and direct voice prompts and indications for a straightforward rescue operation. Lightweight and battery powered for maximum portability. Designed to treat Ventricular Fibrillation (VF) and Fast Ventricular Tachycardia: the most common causes of sudden cardiac arrest (SCA). In SCA, the heart of the victim suddenly stops pumping. The only effective treatment for VF is the application of a defibrillating shock. It may be used on children 1-8 years old (less than 25 kg) with pediatric reduced energy pads, over with adult pads. Supplied with a set of adult pads, lithium battery (200 Shocks or 10 hours operating time), manual. According to ERC Guidelines 2010.

TRAINER: simulates all the functions of i-PAD, with 8 rescue scenarios.

Voice version and manual	i-PAD DEFIBRILLATOR AND TRAINER					
	Spanish	French	Portuguese	Italian	English	Other languages*
DEFIBRILLATOR	33408	33409	33413	33414	33416	33417
TRAINER	-	-	-	33424	33405	33406

*Voice languages: DE, DK, KR, JP, NL, SE, with same language manual, updated to ERC guidelines 2010
*Voice languages: CZ, GR, HU, IL, IR, NO, TR, with English manual, updated to ERC guidelines 2005

code	Original accessories for i-PAD
33418	Lithium battery pack for i-PAD and i-PAD trainer (for 200 Shocks)
33441	Disposable pads - kit of 2 pcs
33443	Disposable pediatric pads - kit of 2 pcs
33422	Carrying bag
33423	Wall cabinet with alarm sound
33403	IrDa connector for data communication + software for event recording download with key file



SPECIALLY DESIGNED FOR PUBLIC USAGE



TECHNICAL SPECIFICATIONS

Operating mode: Semi-automatic
Waveform: e-cube biphasic (Truncated exponential type); impedance compensated
Energy: 200J fixed
Adult: nominal 200J into a 50 ohm load
Infant/child: nominal 50 joules into a 50 ohm load
Shock energy accuracy: Within ±3% (200J into 50 Ω)
Shock to shock cycle time: Typically less than 20 seconds
Protocol: Voice prompts and indicators guide through protocol
Charge control: Automatic by Software (Arrhythmia Detection System and Charging Control)

Charge time from "Shock advised": < 10 seconds, typical
Voice instruction: Voice messages guide through use of defibrillator
Controls: Shock Button, i-Button, On/Off Button
Indicators: 7 LEDs (different colours), i-Button
Patient isolation: Type BF, defibrillation protected
Battery: 12 Volt DC, 4.2 Ah, lithium manganese dioxide, disposable long-life primary cell
Battery capacity: Min. 200 Shocks or 4 hours of operating time
Data recording: Data Stored: First 40 minutes of ECG and the entire incident's events and analysis decision
Size - Weight: 220x260x70 mm - 2.2 kg (4.84 lbs) with battery pack

RESCUE SAM AED DEFIBRILLATORS - SEMI OR FULL AUTOMATIC

5 YEARS WARRANTY
MADE IN ITALY

Rescue Sam with carrying bag 33421

33425 + 33421



Semi or full automatic external defibrillators designed for public use by minimally trained people. They provide easy and simple indications for rescue operations. Designed to treat Ventricular Fibrillation (VF) and Fast Ventricular Tachycardia (VT). Supplied with lithium battery, set of adult pads and manual. According to AHA/ERC Guidelines 2010. Made in Italy.

RESCUE SAM DEFIBRILLATOR - Semi automatic

English	Italian	French	Spanish	Other languages*
33425	33426	33427	33430	33559

Other languages available in 20 days: DE, PL, RU (manual and voice), PT, CZ, FI, GR, LT, NL, RO, TR, KR, TH (voice with English manual)

RESCUE SAM DEFIBRILLATOR - Full automatic

33165	-	33167	-	-
--------------	---	--------------	---	---

German available on request in 20 days

TRAINER FOR SEMI-AUTOMATIC RESCUE SAM

33170	33171	-	-	33174
--------------	--------------	---	---	--------------

Trainer: other languages available in 20 days: ES, FR, PL (voice only)

ACCESSORIES FOR RESCUE SAM DEFIBRILLATORS

33558	USB PC interface	33420	Disposable adult pads with cable
33419	Lithium battery pack		
33458	Disposable pediatric pads (kit of 2)		
33451	Disposable adult pads (kit of 2)		
33420	Disposable adult pads (kit of 2) and cable		
33421	Carrying bag		

TECHNICAL SPECIFICATIONS

Operating mode: Semi-automatic or Full-automatic
Waveform: BTE (Biphasic Exponential Truncated) impedance compensated
Energy: 200 J fixed
Charge control: Automatic by software (Arrhythmia Detection System and charging control)
Charge time: < 8 seconds, typical with new battery
Shock delivery vector: adult pads in the anterior (Lead II) position or reduced energy paediatric pads in anterior-posterior position
Voice instructions: Vocal and optical message guide
Automatic manual tests: Battery insertion test and daily self tests
Long life lithium battery: 12 Volt DC, 4.2 Ah, LiMnO₂, disposable
Battery capacity: 200 shocks or 4 hours of continuous operating time
Data recording, stored: first 60 minutes of ECG and the entire incident's event
Size-weight: 30x28x9 cm - 2.3 kg with battery



TRAINER AED RESCUE SAM PRO
Designed to effectively train emergency responders to the use of RESCUE SAM, thanks to simple, clear, spoken and visual instructions. 5 pre-programmed scenarios selected directly by the remote control. Totally safe real shock simulation. Supplied with remote control, training pads, battery charger.

COMPATIBLE PADS FOR OVER 90% OF DEFIBRILLATORS ON THE MARKET

CE 0086



ADULT COMPATIBLE PADS - disposable

A range of compatible pads BSI certified for patients >8 years (25 kg) for most defibrillators on the market. Excellent adherence and adequate gel thickness. Includes a couple of pads, cable and connector. Maximum shelf life 30 months from production date. Latex free.

Compliance to regulations: Directive 93/42/EEC and amendments. Class IIb medical device. ANSI/AAMI: DF-80; IEC/EN: 60601-1, 60601-2-4; ISO: 10993-1. Made in Italy.

code	BRAND	MODEL	code	BRAND	MODEL
33576	Agilent-Philips	- Heartstream/HeartStart XL M4735A - Heartstream/HeartStart XLT M3500B - HeartStart XL 861290 - HeartStart 4000 M5500B (all with Philips cable M3508A)	33587	Mindray	- Beneheart D3 - Beneheart D6
33577	Agilent Hewlett-Packard	- Codemaster 100-XE-XL-XL+ - Heartstream XL, XLT, XL+ with cable M3507A	33579	MRL	Life - Lifequest
33579	Artema Innomed	- Cardio Aid 100 - 200 - 200B - 360B - XL - XL+	33579	Nihon Kohden	Cardiolife TEC 2202 - 2203 - 5500 - 7531 - 7600 - 7700 - 8251 all with cable JC-755V, TEC 8300 with cable JC855V
33579	Artema S&W	- Cardio Aid LS - MC - MC+	33587	Osatu Bexen	- Reanibex 200 - 300 - 500 - 700 - 800
33587	Cardioline	- Elife 700	33576	Philips Laerdal Medical	- Heartstream Fore Runner I AED models E, S, EM - Heartstart FR1 AED 940010XX - 940020XX - 940030XX - Heartstart FR2 AED M3841A - M3861A - Heartstart FR2+ AED, with ECG module M3840A, M3860A - Codemaster M1722A/B, M1723A/B, M1724A, M2475B (with Philips cable M3507A and pad adapter 05-200) - Heartstart MRx M3535A (with Philips cable M3508A)
33448	Cmos Drake	- Futura	33588	Schiller	- Fred Easy - Fred Easy 2G - Defigard DG4000 - DG5000 - DG6002
33448	CU Medical System	- i-PAD NF1200	33586	Schiller	- Defigard DG1002 - DG3002 - DG2000 EDOS
33578	Defibtech	- DDU 100 Lifeline AED - DDU 120 Lifeline Auto AED	33592	Schiller	- Fred easy port - Argus PRO Lifecare - Argus PRO Lifecare 2 - Cardiovit AT 101 Easy
33579	Drager	- Cardiolog 2000	33579	S&W	- Cardio Aid LS - MC - MC+
33586	Esaote	- MDF SAED - MDF II	33579	Welch-Allyn	- AED 10 - AED20 - PIC30 - PIC40 - PIC50
33579	Innomed	- CardioAid 200B - 200 - 100 - 360B - XL+ - XL	33589	Zoll Medical Corp	- Zoll PD 1200 - 1400 - 1600 - 1700 - 2000 - M series - E series - R series
33577	Laerdal Medical	- HeartStart 4000			
33589	M&B	- AED 7000			
33587	Medtronic-Physiocontrol	- Lifepak 9 connector Quick-Combo - Lifepak 10 - 12 - 15 - 20 - 500 AED pink or grey socket - 1000 AED			
33609	Metrax Primedic	- Heartsave AED - AED-M - 6 - 6S since S.N. 739xxxxxxx - Defimonitor XD			

Connectors to defibrillator of compatible pads

Multilanguage envelope: English, Italian, French, German, Spanish, Portuguese, Greek, Dutch, Russian, Swedish



PEDIATRIC COMPATIBLE PADS WITH ENERGY REDUCTION SYSTEM

PEDIATRIC COMPATIBLE PADS - disposable

These pads have an energy reduction system: defibrillator output of 150J (33606) or 200J (33603) is reduced to 50J. International RCP guidelines state 8 years as limit age for

pediatric treatment, corresponding to about 25 kg according to standard growth curves. Compliance to regulation as above adult compatible pads. Latex free. Made in Italy.

code	BRAND - MODEL	code	BRAND - MODEL
33603	Medtronic-Physiocontrol - Lifepak 500 AED pink socket - Lifepak 1000 AED - Lifepak CR plus AED - Lifepak Express AED	33606	Philips Laerdal Medical - Heartstart FR2 AED M3841A & M3861A - Heartstart FR2 AED, with ECG module 3840A, M3861A

ORIGINAL CU, PRIMEDIC AND PROGETTI PADS

code	BRAND - MODEL	code	BRAND - MODEL
PEDIATRIC PADS		ADULT PADS	
33569	CU Medical System CU-ER1, CU-ER2, CU-ER3	33565	CU Medical System CU-ER1, CU-ER2, CU-ER3
33443	iPad NF 1200	33441	iPad NF 1200
35345	CU-SP1, CU-SP2	35344	CU-SP1, CU-SP2
35390	Metrax-Primedic HeartSave Pad, AED, AED-M, 6, 6S since S.N. 739xxxxxxx	35392	Metrax-Primedic HeartSave Pad, AED, AED-M, 6, 6S since S.N. 739xxxxxxx
33458	Progetti Rescue Sam, Rescue 230, Rescue Life 5.7" and 7"	33388	Progetti HeartSave Pad, AED, AED-M, 6, 6S up to S.N. 738xxxxxxx
		35380	Defimonitor XD1, XD3, XD10, XD30, XD100, XD300, XD110, XD330
		33451	Progetti Rescue Sam, Rescue 230, Rescue Life 5.7 "and 7"

PRIMEDIC™ EXTERNAL DEFIBRILLATORS - AED

PRIMEDIC HeartSave product range is easy to operate and offers fast operation. Clear voice prompts guide first aiders through the rescue procedure.

Current controlled defibrillation - CCD

CCD Biphasic technology delivers peak-free current defibrillation on the patient's heart muscle through its individualized, gentle, effective and current-controlled defibrillation pulse. Featuring an escalating defibrillation strategy, HeartSave is impedance compensated and capable of a maximum energy of 360J.

Effective workflow

HeartSave is designed to help first aiders delivering the most effective life support. Through its advanced workflow, HeartSave supports the rescuer in minimizing the perishock pause as well as no-flow fraction.

Pediatric mode

At a touch of a button the Paediatric Mode can be promptly selected. No need of dedicated paediatric electrodes and extreme ease of use result in optimized costs of maintenance and prompt operation.

Fast

It turns on automatically as soon as the cover has been opened and rhythm analysis starts immediately as the pre-connected electrodes are attached to the patient. All accessories (razor, breathing mask, scissors and gloves) are included.

Status display

Active status display provides comprehensive information on the device's operating status and battery status (daily and monthly self-tests).

HEARTSAVE PAD and HEARTSAVE AED

Automatic external defibrillator with 3 years life (PAD) or 6 years life (AED) in standby mode with non rechargeable lithium battery.

The HeartSave AED has 4 selectable languages.

HEARTSAVE AED-M

Same features as HeartSave AED, plus large LCD display for ECG waveform, HR, shockable rhythm counts and other relevant information. AED-M is supplied with non rechargeable lithium battery

HEARTSAVE 6

For professional and non professional users. In addition to the AED-M features, HeartSave 6 offers both AED and MANUAL mode, 6 leads ECG, alarms and SYNC for Cardioversion.



PRIMEDIC™
Saves Life. Everywhere.

High resolution LCD monitor gives important information for resuscitation



HEART SAVE EXTERNAL DEFIBRILLATORS		Voice version and manual			
	WITH LITHIUM BATTERY 140 DISCHARGES AT 360J 3 YEARS STANDBY	Italian	English	French	Other languages**
	HeartSave PAD	33393	33395	33398	33402

** We can provide following languages (voice + manual): ES, PT, GR, DK, FI, CZ, PL, DE, SE BG, RU, TR, AE, IR, BR, HU, TH, JP, RO, SI, IL. Only voice: MK, HR, FI, NL, LT, IS, IL, KT, TR, IR, BR, JP. Only manual NO.

AED		Voice version and manual			
	WITH LITHIUM BATTERY 200 DISCHARGES AT 360J 6 YEARS STANDBY	English Spanish Greek Portuguese	Italian French German Polish	Other languages***	
	HeartSave AED HeartSave AED-M	33391 33396	33392 33397	33394 33399	

WITH AKUPAK LITE RECHARGEABLE BATTERY AND CLIP CHARGER		Voice version and manual			
	HeartSave AED-M	English Italian Spanish French	English Spanish Greek Portuguese	Italian French German Polish	Other languages***
	HeartSave 6	33440 -	- 33452	- 33453	33446 33456

***We can provide following languages (voice + manual): BG, CZ, DK, FI, HR, HU, MK, NL, NO, RO, RU, SE, SI, TR, AE, CN, IR, TH. Please specify with order. Available in 40/60 days.

SAVEPADS	GB, IT, FR, ES	Other languages
Self-adhesive electrode, cable, razor and gloves - shelf life 3 years		
SavePads mini for 1-8 years max 25 kg	35390	35391
SavePads preconnect for over 8 years, 25 kg Since S. N. 7390000000	35392	35393
SavePads for over 8 years 25 kg Only for 33384/5 and AED sold before April 2014 up to S.N. 738000000	33388	33386

ACCESSORIES - SPARES		
Lithium BATTERY - not rechargeable life 6 years for AED and AED-M	33387	33387
AkuPak Lite Rechargeable battery****	33400	33400
PowerPak Battery charger for code 33400	33407	33407
Flashcard ERC guidelines update (2010 to 2015)****	33401	33401

****For defibrillators sold up to December 2010 - Specify serial number with order *****For AED-M and HeartSave

STANDARD ACCESSORIES		
Lithium battery, 3 years stand-by (140 shocks @360J), (PAD only)		
Lithium battery, 6 years stand-by (200 shocks @360J), (AED, AED-M*)		
AkuPak Lite, rechargeable battery with clip charger, (AED-M*, H56)		
ECG cable 3 leads (HeartSave 6 only)		
SavePads		
Data and voice recording		
Manual		

*AED-M is available with lithium battery or with Akupak Lite rechargeable battery. Select code for requested model

	TECHNICAL SPECIFICATIONS					PAD	AED	AED-M	H56
	PAD	AED	AED-M	H56					
Defibrillation									
Semi-automatic mode	•	•	•	•					
Manual mode									
Wave: biphasic, current controlled pulse	•	•	•	•					
Energy 50-360J	•	•	•	•					
Charging time: < 12 sec @ 360J	•	•	•	•					
Operating modes: asynchronous	•	•	•	•					
Paediatric mode	•	•	•	•					
ECG									
Lead: II			•						
I, II, III, aVR, aVF, aVL				•					
Patient's impedance range: 23-200 Ohm	•	•	•	•					
Heart rate: 30-300 per min	•	•	•	•					
VF:VT Detection									
VF/VT Detection	•	•	•	•					
Analysis time 7-12 sec	•	•	•	•					
Asystole threshold <0.2mV	•	•	•	•					
Artefact-Pacemaker detection	•	•	•	•					
Electrodes									
Non polarized electrodes, cable length 2 m	•	•	•	•					
LCD Monitor									
95x72 mm (diagonal 4.7"/120 mm)									
320x240 (pixel size 0.36x0.36 mm)									
Storage battery status display									
Speed 25 mm/s									
Heart rate, number of defibrillation, number of VF/VT, total resuscitation time									
Data backup									
Removable memory		•	•	•					
Voice recording		•	•	•					
Power supply									
Lithium battery 3 years life or 140 discharges at 360J		•	•	•					
Lithium battery 6 years life or 200 discharges at 200J - 15 hours monitoring			•	•					
AkuPak Lite with rechargeable battery									
100-240 V, 50/60 Hz - 150 discharges at 200J									
- 5 hours monitoring									
Status display									
Defibrillator and battery status visualization	•	•	•	•					

PRIMEDIC™ DefiMonitor XD - PROFESSIONAL DEFIBRILLATORS

DEFIMONITOR XD

The sophisticated high performance instrument with multifunctional features.

It combines a compact product design, proved and tested in practice with the highest possible degree of safety and user friendly handling.

Range of 8 manual (XD1, XD3, XD10, XD30) or manual + AED (XD100, XD300, XD110, XD330) defibrillators with or without SpO₂ and external pacer.

Supplied with adult/pediatric paddles, disposable adult Save Pads, connect cable, ECG cable, power cable, 1 tube gel, 1 paper roll.

Standard software: GB, FR, DE, IT, ES, KT, PT, RO, TR, CN.

Manual: GB, IT (on request DE, ES, PT, RU, UA).

Other softwares available on request: CZ, FI, HU, NL, NO, PL, RU, SE, DK, GR, LT, JU, AE, BR, CN, IR, JP, TH, US.



Size: 33x29x16 cm

EN 1789

MADE IN GERMANY

code	DefiMonitors XD
35370	DefiMonitor XD1 manual
35371	DefiMonitor XD3 manual + SpO ₂
35372	DefiMonitor XD10 manual + pacer
35373	DefiMonitor XD30 manual + SpO ₂ + pacer
35374	DefiMonitor XD100 manual + AED
35375	DefiMonitor XD300 manual + AED + SpO ₂
35376	DefiMonitor XD110 manual + AED + pacer
35377	DefiMonitor XD330 manual + AED + SpO ₂ + pacer

code	Accessories for DefiMonitors XD
35380	SAVE PADS Connect GB, FR, IT, ES (require cable 35384)
35383	SAVE PADS Connect other languages (require cable 35384)
35384	Connect cable for SAVE PADS Connect 35380/3 - spare
33400	AKuPak LITE rechargeable battery
35386	Charge base for 33400 for DefiMonitor XD
35387	Paper roll 58 mm x25 m - box of 10
35388	DefiMonitor carrying bag with shoulder strap

TECHNICAL SPECIFICATIONS

	XD1	XD3	XD10	XD30	XD100	XD300	XD110	XD330		XD1	XD3	XD10	XD30	XD100	XD300	XD110	XD330	
Defibrillation									TFT LCD blue-mode monitor									
Wave: biphasic, current controlled impulse	•	•	•	•	•	•	•	•	115x86 mm (diagonal 5.7"/144 mm)	•	•	•	•	•	•	•	•	•
Energy (automatic mode) 140-360 J	•	•	•	•	•	•	•	•	320x240 pixels	•	•	•	•	•	•	•	•	•
Manual energy stages:									Electrodes									
5J, 10J, 20J, 30J, 50J, 100J, 200J, 300J, 360J	•	•	•	•	•	•	•	•	Adhesive electrodes, 3 years shelf life	•	•	•	•	•	•	•	•	•
Charging time: < 6 sec at 200 J	•	•	•	•	•	•	•	•	Cable length 3.5 m Save pads connect	•	•	•	•	•	•	•	•	•
Cardio version: manual activation, QRS marker	•	•	•	•	•	•	•	•	Data backup									
ECG									Removable memory 2 GB	•	•	•	•	•	•	•	•	•
Derivation: Eindhoven I, II, III	•	•	•	•	•	•	•	•	Data/Voice recording up to 35 h	•	•	•	•	•	•	•	•	•
Goldberger, aVR, aVF, aVL	•	•	•	•	•	•	•	•	Power supply									
Patient's resistance: 23-200 Ohm	•	•	•	•	•	•	•	•	Voltage 90-264 V, 50/60 Hz	•	•	•	•	•	•	•	•	•
Heart rate: 30-300 per min	•	•	•	•	•	•	•	•	Rechargeable Lithium-ion battery (LiFePO₄):									
VF: recogniton									Capacity 2.5 Ah Voltage: 13.2 Vdc	•	•	•	•	•	•	•	•	•
VF recogniton	•	•	•	•	•	•	•	•	Discharges 160-200 J	•	•	•	•	•	•	•	•	•
Analysis time 7-12 sec	•	•	•	•	•	•	•	•	Monitoring 5.30 h Charging time: 3.2 h	•	•	•	•	•	•	•	•	•
VF threshold 200 µV	•	•	•	•	•	•	•	•	Resuscitation guidelines									
Asystole threshold < 200 µV	•	•	•	•	•	•	•	•	AHA/ERC	•	•	•	•	•	•	•	•	•
Artefact, Pacemaker detection	•	•	•	•	•	•	•	•	Standards									
Pulse Oximeter									IEC60601-1:1988+A1:1991+A2:1995	•	•	•	•	•	•	•	•	•
Nellcor Oximax	•	•	•	•	•	•	•	•	(Electrical Safety of Med. Electrical Devices)	•	•	•	•	•	•	•	•	•
Pacer									IEC60601-1-2:2001 (Electromagnetic compatibility)	•	•	•	•	•	•	•	•	•
Trans thoracic heart pacemaker	•	•	•	•	•	•	•	•	IEC60601-1-4:1996+A1:1999	•	•	•	•	•	•	•	•	•
Modes: fix, demand, overdrive	•	•	•	•	•	•	•	•	(Programmable electrical medical systems)	•	•	•	•	•	•	•	•	•
Thermal printer									IEC60601-2-4:2002 (Defibrillators)	•	•	•	•	•	•	•	•	•
Resolution: 200 dpi	•	•	•	•	•	•	•	•	EN1789:2003 (Ambulance standard)	•	•	•	•	•	•	•	•	•
Advance: 25 mm/s, 50 mm/s	•	•	•	•	•	•	•	•	Protection class IP33	•	•	•	•	•	•	•	•	•

DEFI-B BATTERY DEFIBRILLATOR - MADE IN GERMANY



33380

In emergency situation the well structured and logical operator guidance may save a life

Suitable for adult and children (reference norms ERC 2005 use of joule depending on kg).

Compact and handy: PRIMEDIC DEFI-B is easily transportable and immediately ready to use everywhere

• 33380 DEFI-B DEFIBRILLATOR - 220 V

The mobile security: PRIMEDIC DEFI-B is a state-of-the-art accumulator-driven defibrillator. It was designed in accordance with strict requirements of emergency medical science. Fully developed and reliable technique, world-wide in use since years. PRIMEDIC DEFI-B is



a battery supplied version and has proved successful in daily use in ambulances, with cardio sport groups and in hospitals. The convincing advantages: PRIMEDIC DEFI-B is immediately ready for application and is not depending on the main power supply due to large accumulator capacity. After switching on, the defibrillator carry out an internal self-test. In order to ensure a functional optimal handling, the user is supported by clear instructions and pictograms. A shock-resistant plastic casing protects the device, especially under rough conditions.

• 33381 SPARE BATTERY

TECHNICAL SPECIFICATIONS

Mode: Asynchronous, external defibrillator
 Energy step: 20, 50, 100, 160, 250, 360 Joule
 Discharges: 45 shocks at 360 Joule, (10 reserve after signal "battery low")
 Charging time: 2 sec up to 100 Joule, 4.5 sec up to 360 Joule
 Paddles for children integrated
 Accumulator: 14.4 V / 1.4 Ah
 Charging time: 3.5 hours
 Safety: Internal discharge of energy after 15 sec. Internal self-testing and fault recognition Protection class II, type BF
 Mains voltage: 200-240 V 50/60 Hz
 Dimensions: 40x48x12 cm (W x D x H)



Weight: 8.5 kg

RESCUE 230 BIPHASIC MANUAL DEFIBRILLATOR

RESCUE 230 BIPHASIC MANUAL DEFIBRILLATOR

A range of 2 professional models with advanced features:

- BTE (Biphasic Truncated Exponential) discharge type
- impedance compensated energy delivery
- energy selection from 2 to 230 joule directly from the front panel
- charge time 5 sec for 230 joule with fully charged battery
- 100 shocks of 230 j with fully charged batteries
- charge/discharge control from the paddles
- ECG 'R' wave synchro mode or async mode
- large (5.7") high resolution backlight LCD display (320x240 dots)
- ECG through the paddles or through patient cable
- adjustable HR and SpO₂ alarms limits

- 33447 RESCUE 230 BIPHASIC DEFIBRILLATOR

- 33457 RESCUE 230 BIPHASIC DEFIBRILLATOR WITH PACEMAKER

(rectangular pulse, pulse duration 22 msec, pulse max amplitude 150 V, stimulation frequency 30 to 150 BPM)

- 33458 DISPOSABLE PADDLES - box of 2 - pediatric

- 33451 DISPOSABLE PADDLES - box of 2 - adult

- 33449 CABLE/ADAPTOR FOR DISPOSABLE PADDLES

- 33439 SpO₂ PROBE

- 33250 THERMAL PAPER



Battery charging car plug on request

TECHNICAL SPECIFICATIONS

Display:

- large (5.7") high resolution backlight LCD display (320x240 dots)
- ECG through the discharge paddles (1 trace) or through 4 leads patient cable (6 traces): I, II, III, aVR, aVL, aVF
- Automatic change over when plugging the patient cable
- Filters: 50/60 Hz, base line, low pass
- heart rate indicator

Printer:

- auto printing mode
- integrated thermal printer for ECG traces and events documentation hardcopy
- paper speed 5, 10, 25 mm/sec (paper width 58 mm)

Safety:

- two hands safety shock release
- ECG input insulation CF class
- internal discharge after 30 sec of standby after charge

Power supply: internal Ni-Cd high capacity batteries (charging time 95%: 2 hours) universal mains adaptor charger 110/220 VAC, 50/60 Hz

Dimensions: 34x26x13 cm Weight: 5.5 kg Made in Italy

33447



Adult and pediatric standard pads



33451

Optional paddles for monitoring

STANDARD ACCESSORIES

- Internal Ni-Cd high capacity battery
- Carrying case
- Patient cable 4 leads
- Manual GB, IT, on request ES, TR

- Printer
- 1 paper roll
- 2 reusable paddles
- Mains adaptor charger
- Disposable paddle*+cable*

*Only for 33457

AMBU® TRAINING MANIKINS

- 34044 AMBU® MAN COMPRESSION

A basic instruction and training manikin for the practice of external chest compression that meets recommendations of AHA (American Heart Association) and ERC (European Resuscitation Council). With the size of a normal adult torso, provides a life-like representation of human anatomy. **Indicator for correct compression**

The manikin includes an indicator bar that shows the correct compression depth, changing colour from red to green.

Compact and portable Easy AED training

Due to the closed shaped torso, defibrillation pads can be placed and AED training can be performed realistically. Weight: 2.0 kg

Size: 45x37x25 cm

Max compression depth: 7.5 cm

Manual in: GB, FR, IT, ES, DE, PT, GR, HU, DK, PL, NO, SE, SI, CZ, TR, JP, CN.



34044

- 34047 AMBU® MAN BASIC

Cost efficient and reliable training manikin designed to fulfill all requirements for the BLS algorithm training. The closed shaped torso with its anatomical correct landmarks allows trainees to learn and train the use of Automatic External Defibrillators (AED) and the placement of pads. It allows an optimal training of chest compression in combination with realistic ventilation. The unique hygienic system prevents cross contamination. It allows a realistic ventilation resistance and expiration through mouth and nose. The correct compression depth and required ventilation volume can be monitored by the feedback indicator on the manikin.

Ventilation as in real life

The trainees will feel the realistic airway resistance and the chest will start rising when the head is correctly tilted and air blown into the manikin. Weight: 6.0 kg. Size: 70x37 cm

Max ventilation: 1,200 ml

Max compression depth: 7.5 cm

Manual in: GB, FR, IT, ES, DE, PT, HU, DK, NL, PL, CZ, TR.

- 34039 HEAD BAG - box of 100 pcs



34047

- 34042 AMBU® AIRWAY MAN I Adjustable stiffness

- 34049 AMBU® AIRWAY MAN W with CPR

Adult-sized training manikins that provide an optimal lifelike representation of the human anatomy. **Mechanical instrument** gives you instant feedback on ventilation volume, stomach inflation, chest compression depth in mm and wrong hand position. **PC connection (34049 only)** of Ambu CPR Software Kit, Ambu CPR Printer or USB Interface. **Make intubation possible** with ET tube, Guedel, Laryngeal Mask and combi-tube. Ambu Airway man includes torso with hooks for arms, computer interface with CPR software kit (34049 only), supplied in track suit jacket and training mat. CPR software kit selectable languages: GB, FR, IT, ES, DE, PT, PL, DK, HU, NL, RU, JP.

Size: 80x35 cm Weight: 13 kg

• 34043 COMPLETE SET: ARMS, LEGS, TROUSERS AND BAG



34042

Size: 80x35 cm Weight: 13 kg

RESCUE LIFE MANUAL AND SEMIAUTOMATIC DEFIBRILLATORS

Bright, high contrast, wide-angle TFT LCD colour display 5.7" to view simultaneously up to 3 ECG channels

Ergonomic design. Impact proof, compact and lightweight. Comfortable and washable carrying bag keeps all accessories at hand and protects Rescue

RESCUE 7 ONLY:
- 7" TFT COLOUR DISPLAY
- AUTOMATIC SELF TEST

MADE IN ITALY

AVAILABLE WITH:

- SpO₂
- NIBP
- PACEMAKER

YOU MAY ORDER UNIT WITH 1 TO 3 OF ABOVE PARAMETERS

Fast connection.

User can choose between ergonomic reusable paddles for manual defibrillator or disposable pads for AED defibrillation.

Both types are equipped with a single fast lock connection for reliable rescue operations



RESCUE LIFE 7"



Large TFT LCD colour display 7"



Adult and pediatric reusable paddles

RESCUE LIFE BIPHASIC DEFIBRILLATORS 5.7" and 7"

Rescue Life is an external defibrillator with monitor. It is designed to be used by out-of-hospital and hospital users. Lightweight, transport facility, attractive line, ergonomic shape, studied in every details. It is a complete acute cardiac care response system designed for Basic Life Support (BLS) and Advanced Life Support (ALS) patient management protocols. The IPX4 standard permits the operation under adverse climatic situations. Rescue Life is totally MADE IN ITALY.

SpO₂ and pacemaker

Range includes models with pacemaker and SpO₂. ECG module for monitoring (not for diagnosis) includes up to 12 derivations standard 5 leads patient cable (for I, II, III, aVL, aVR, aVF) or optional 10 leads patient cable (for 12 derivations).

NIBP

The NIBP option is focused on advantage A+ module of SunTech Medical that provides the highest NIBP performance during movements. Suitable for adult, pediatric and neonatal.

High contrast TFT LCD colour display 5.7" or 7" (Rescue Life 7) Bright, high contrast, wide-angle colour display for simultaneous view of up to 3 ECG channels

Data management

The memory is based on a flash disk of 4 GB for 300 recorded hours for all AED models

Asynchronous and synchronous

- in *asynchronous* defibrillation, Rescue is advised on patients with the following symptoms: unconsciousness, absence of normal breathing and lack of detectable pulse.

- in *synchronous* defibrillation, Rescue Life is advised on patients with ECG's reporting Atrial Fibrillation.

3 operation modes: manual, AED, Advisory

- in *manual mode* RESCUE LIFE is intended for use by doctors and trained individuals. Only 3 steps: energy selection from 1 to 230J, energy charge and shock.

- in *AED mode*, RESCUE LIFE is intended for use by personnel authorized by a physician or medical director. The voice prompts and display messages are assisting the operator during CPR operations, charging automatically to 150J when a shock-able ECG rhythm is detected.

- in *advisory Mode*, the system alerts when the shock is necessary leaving the energy level and charging choice to the operator.

Initialising and system test at switching on of the device (Rescue Life 7 only)

Auto test and fault recognition (Rescue Life 7 only).

Clinical test

Available on our web site.

STANDARD ACCESSORIES

- Internal Ni-Mh battery (Rescue 5.7")
- Internal Li-Ion battery (Rescue 7")
- Manual: GB, IT
- Printer
- 1 paper roll
- 2 adult and pediatric reusable paddles
- 2 disposable pads (AED only)
- Main adaptor charger
- Patient cables 5 leads

English	Italian	Other languages	RESCUE LIFE 5.7" DEFIBRILLATORS
33590	33537	33538*	Rescue life defibrillator
33597	33540	33541*	Rescue life defibrillator with SpO ₂
33591	33543	33544*	Rescue life AED defibrillator with pacemaker
33598	33545	33546*	Rescue life AED defibrillator with SpO ₂
33547	33548	33549*	Rescue life AED defib. SpO ₂ +NIBP+Pacemaker
		33539**	Rescue life AED defib. other configuration

*On request we can offer Rescue Life and Rescue Life AED in Spanish and French

**On request we can offer Rescue Life and Rescue Life AED with SpO₂+NIBP, SpO₂+Pacemaker (available in GB, FR, IT, ES)

English	Italian	RESCUE LIFE 7" DEFIBRILLATORS
33182	33183	Rescue Life 7 defibrillator
33185	33186	Rescue Life 7 AED
33188	33189	Rescue Life 7 AED defib. other configurations*

*On request we can offer Rescue Life 7 with SpO₂, NIBP or Pacemaker.

You can choose 1 to 3 of above parameters. *Available on request manual in FR and ES.

code	RESCUE LIFE ACCESSORIES
33448	Disposable paddles - box of 2 - adult - compatible
33451	Disposable paddles - box of 2 - adult - original
33458	Disposable paddles - box of 2 - pediatric - original
33593	Cable for disposable paddles
33594	ECG cable 10 leads
33595	Rescue Life bag
33250	Thermal paper
33596	12V car light adapter - inverter

TECHNICAL SPECIFICATIONS

- Display:**
- high contrast TFT colour LCD 5.7" (320x240 pixel) or LCD 7" (800x480 dots)
 - ECG through the discharge paddles (1 trace) or through 5, 10 leads patient cable for 3, 6, or 12 traces and SpO₂ value
 - Automatic change over when plugging the patient cable
 - filters: 50/60 Hz, base line, EMG
 - heart rate indicator
- ECG monitoring**
- bandwidth: 0.5 to 120 Hz (-3db) with filters off
 - speed: 5, 10, 25, 50 mm/sec.
 - gain: 2.5, 5, 10, 20, 40 mm/mV with patient cable; auto with paddles
 - HR digital readout on the display 20 to 300 bpm (± 2%)
 - alarm: settable HR, min 20 bpm, max 250 bpm
- Pulse oxymetry (SpO₂) 33540-1-5-6-7-8-9, 33597-8 only**
- oxygen saturation range: 0 to 100%
 - pulse rate range: 30 - 250 pulses per minute
 - accuracy SpO₂: 70-100% ± 2 digits for adults using the finger clip sensor
 - SpO₂ Alarms adjustable (min. 50%)
- Non-invasive pacemaker (33543-4, 33591, 33547-8-9)**
- rectangular wave
 - operating mode: fixed on demand
 - pulse rate: 0 to 180 ppm adjustable in steps of 5 ppm
 - impulse duration: 22 ms
 - pulse Current: 0 to 180 mA adjustable in steps of 5 mA

- amplitude: MAX 150 V
- **NIBP (33547-8-9 only)**
- technique: oscillometric
- accuracy: meets ANSI/AAMI SP10-2002, EN 1060-4
- patient application: adult/pediatric/neonatal
- range mmHg

	adult	pediatric	neonatal
systolic	40-260	40-160	40-130
MAP	26-220	26-133	26-110
diastolic	20-200	20-120	20-100

- **Printer:**

 - manual, automatic (10" pre and post recording)
 - integrated thermal printer for ECG traces and events documentation including HR/SpO₂ values
 - paper speed: 5, 10, 25, 50 mm/sec.
 - paper width: 58 mm

- **Safety:**

 - two hand safety shock release
 - ECG input insulation CF class
 - internal discharge after 30 sec. of standby after charge

- **Power supply:**

 - internal Ni-Mh battery (Rescue Life 5.7")
 - internal Li-Ion battery (Rescue Life 7") (charging time 95%: 2 hours)
 - AC 100-240 VAC, 50/60 Hz
 - Memory: internal flash 4 GB up to 300 hours of ECG data, events and usage review

- **General:**

 - Dimensions: 36x24x34 cm
 - Weight: 5.5 kg with battery

DTS-3000 SMART PNEUMATIC TOURNIQUET SYSTEM



33138



33138
+
33139



STANDARD ACCESSORIES

- No pinch single cuff 61x9 cm - red - arm L or thigh S
- No pinch single cuff 80x9 cm - blue - thigh - M
- No pinch single cone cuff 90x12 cm - blue - thigh - L
- No pinch double cuff 57x10 cm - blue - arm - M
- No pinch double cuff 80x15 cm - red - thigh - M
- Air hose
- Power cord
- LOP sensor
- User manual (GB, IT)

TECHNICAL SPECIFICATIONS

- Max pressure: 800 mmHg
- Voltage: Ac 100-240 V - 50/60 Hz
- Power consumption: 50 W
- Time range: 5-180 min.
- Compressor dimension - weight: 170x210x260 mm - 3 kg

- 33138 DTS-3000 PNEUMATIC TOURNIQUET - 2 channels for 2 double cuffs or 2 single cuffs with 5 no pinch cuffs
- DTS-3000 provides stable operation, easy setup and effective alarm system for safe surgery in an operation room.

System features

- 2 channels (4 ports for 2 double cuffs or single cuffs)
- easy settings by touch key operation
- graphic LCD screen: easy checking and cleaning
- operation recording (date, time, pressure)
- LOP (Limb Occlusion Pressure) sensor to check limb occlusion pressure and set automatically the optimized pressure
- self test of pressure and system check
- self air pressure sensor calibration
- safety alarm system (cuff, pressure, battery, time)
- built-in battery (max life time: 12-72 hours)

Full autoclavable no pinch cuffs included

- no pinching, no damage to the skin
- lower pressure compared to normal cuff (about 50 mmHg lower)
- no leaking (main reason for lower pressure)

• 33139 TROLLEY

Standard	No pinch	CUFFS for DTS-2000 and DTS-3000	Size	
			Arm	Thigh
-	33141	Single cuff 61x9 cm - red	L	S
-	33142	Single cuff 80x9 cm - blue		M
33160	-	Single cone cuff 70x10 cm		
33161	33144	Single cone cuff 90x12 cm - blue		L
-	33145	Double cuff 57x10 cm - blue	M	
-	33146	Double cuff 80x15 cm - red		M

No pinch arm



INTENDED USE OF TOURNIQUET SYSTEM

- To be used by qualified medical professionals to temporarily occlude blood flow in patient's extremities during surgical procedures. Tourniquet has been found useful in producing bloodless operation field in surgical procedures involving the extremities including:
- reduction of certain fractures
 - Kirschner wire removal
 - tumor and cyst excision
 - subcutaneous fasciotomy
 - nerve injuries
 - bone grafts
 - total wrist joint replacements
 - replacement of joints in the fingers
 - knee joint replacements
 - amputations
 - replantations
 - tendon repair

RIESTER INFUSION CUFFS

- 32684 RIESTER METPAK® INFUSION CUFF - 500 cc - latex free
 - 32685 RIESTER METPAK® INFUSION CUFF - 1,000 cc - latex free
 - 32683 RIESTER METPAK® INFUSION CUFF - 3,000 cc - latex free
- Pressure cuff for infusion with high quality chrome-plated gauge Ø 49 mm up to 300 mmHg.
Made in Germany.



32684



Sturdy blue cotton cuff washable at 60°

ECONOMIC INFUSION CUFF



32680

- 32680 INFUSION CUFF - 500 cc
- Infusion cuff similar to above. Latex bladder and bulb. Made in Asia.

PNEUMATIC TOURNIQUET

- 33150 RIESTER PNEUMATIC TOURNIQUET with adult arm and thigh cuff - latex free bladder
- 33151 CHILD CUFF 38x8 cm - latex free bladder
- 33148 ADULT CUFF 57x9 cm - latex free bladder - spare
- 33149 THIGH CUFF 96x13 cm - latex free bladder - spare

- Reliable pneumatic tourniquet used during amputations to restrict blood circulation in the limbs. A robust and accurate manometer provide exact measurements and a long service life.
- sturdy metal pump to produce pressure
 - air in the cuff can escape by opening the release valve
 - chromium-plated metal manometer with easy-to-read aluminium scale up to 700 mmHg.
- Supplied with 2 cuffs (upper arm 57x9 cm and thigh 96x13 cm) with latex-free bladders.



33150

VOLUMETRIC INFUSION PUMP

• 35200 INFUSION PUMP IP-7700

This pump using peristaltic method is a cutting-edge pump realizing high flow precision with compatibility with I.V. set of various brands through ultrasonic bubble detection. IP-7700 provides simple and easy setup process with its numerical silicon keypad. FND and color LCD provides complete information and user gets the information at one glance. Most infusion condition such as K.V.O. rate, purge rate and bolus can be setup as operating application. Supplied with battery.

Main features

- **Light and compact design:** light as 3.5 kg, compact design, and easy to use.
- **Standard compatibility with 4 brands of IV SET:** TERUMO (TS PA 200L), BD (A122), KOREAN VACCINE (1 and 2), ARIES. Each pump can be calibrated for up to 9 different IV set.
- **Flexible flow setting and easy operation method:** Flow-setting range of 1-1000 ml/h, 0.1-999.9 ml/h is available for wide range settings and numerical keypad is easy to use for setting flow-volume.
- **Full program dosage feature (option):** it can calculate the right flow rate for a patient and inject promptly.
- **Easy recognition of alarm:** it notifies errors and emergencies with LED light and buzzer, simultaneous visual and audio alarm system.
- **Notifying remaining battery:** battery LED is attached to notify charged battery showing remaining battery and when to recharge.
- **Keep Vein Open feature:** when reached preset value, it converts to low flow speed of 3ml/h (when IV set is 15, 19, 20 drops/ml) or 1ml/h (when IV set is 60 drops/ml) automatically to prevent flow route clog due to blood coagulation.
- **Ultrasonic air bubble detector**
- **Suitable also for VET use**
- **35202 DROP SENSOR - for more accurate dropping control (suggested for ICU and new born)**
- **35211 DOSAGE AND PROFILE PROGRAM need Serial Number**
- **35203 Ni-Cd BATTERY - spare**
- **26073 I.V. SET ARIES - box of 150 (6 bags of 25)**
- **35204 ADAPTER 110 V - 60 Hz - for 35200**

Flow volume setting range
1-1000 ml/h (1 ml infusion interval)
0.1-999.9 ml/h (0.1 ml infusion interval)
Flow volume error margin ±5%
Infusion limit volume range
1-9999 ml
Total estimated volume range
1-9999 ml
K.V.O rate (Keep Vein Open)
1 ml/h - 10 ml/h adjustable
Pump method Peristaltic method
Size (WxDxH) 100x190x250 mm
Weight 3.5 kg (battery included)

Rapid flow volume (Purge)
1-1000 ml/h adjustable
Bolus 1-1000 ml/h adjustable
Alarm features
Air in line, occlusion, flow error (free flow), door open, K.V.O. (Infusion completion), standby, low battery, alarm, device malfunction (CPU error), empty container (with optional drop sensor)
Special features
Keypad lock, retain memory, remaining time, alarm repeat, open system, K.V.O., purge, bolus, occ. level, history call-back.

Power
AC 230V, 50/60Hz and DC9.6V inner source adapter DC 12 / 24V - 2A Switchable at 110V / 60Hz - with adapter 35204
Maximum power consumption 40VA
Electric protection levels
Class II B, inner source device, CF type
Waterproof level IPX2
Battery type Ni-Mh rechargeable
Battery using time
4 hrs (when infusing 125 ml/h)
Battery recharging time Minimum 6 hours.
Battery life approx 6 months

TECHNICAL SPECIFICATIONS

CALIBRATION TO ANY IV SET BRAND
Please send 5 samples of your pump use IV set.
Delivery in 40 days

Colour LCD

IV clamp included

English and Italian manual

Automatic setup system (flow rate, time, delivery volume)

Numerical silicone key pads



AUTO SYRINGE PUMP

• 35205 SYRINGE PUMP SP-8800

SP-8800 provides easy syringe installing through one-touch method by slider hook, simple and easy setup process with its numerical silicon keypad. Color LCD displays infusion information dramatically shortcut key manages easy approach for frequent functions. K.V.O. rate, purge rate, bolus and anti bolus can be setup as operating application. Supplied with battery.

Flexible flow volume setting.

Full program dosage feature (optional): it automatically calculates flow rate by patient's weight, injection's mass and melting.

Keep Vein Open (K. V. O.) feature: When reached to the preset value, it converts to low flow speed of 0.1 ml/h automatically to prevent flow route clog due to blood coagulation.

Standard compatibility with 5 major brands of syringes*: Setting feature enables you to choose from following syringe brands: BD (Precise), TERUMO, RAYS, PENTAFERTE, KOVA. Each pump can be calibrated for up to 9 different syringes. Alarm and notification feature: It notifies errors and emergencies with LED light and buzzer. Simultaneous visual and audio alarm. Occlusion error range setting: You can set the pressure level of occlusion stage to High, Medium and Low by patient's age condition. Suitable also for VET use.

- **35210 Ni-MH BATTERY- spare**
- **35211 DOSAGE AND PROFILE PROGRAM need Serial Number**
- **23857 BD SYRINGES 50 ml LL - box of 60 - BD 300865**
- **35204 ADAPTER 110 V - 60 Hz - for 35205**

Flow volume setting range
Syringe 10ml: 0.1-300 ml/h
Syringe 20ml: 0.1-400 ml/h
Syringe 30ml: 0.1-500 ml/h
Syringe 50ml: 0.1-1,200 ml/h
Flow volume error margin ±3%
Infusion limit volume range
0.1-999.9ml (0.1 ml infusion interval)
Total estimated volume range
0.1-999.9ml (0.1ml infusion interval)
K.V.O rate (Vein maintaining function)
1-10 ml/h adjustable
Size (WxDxH) 220x130x108 mm
Weight 2 kg (battery included)

TECHNICAL SPECIFICATIONS

Rapid flow volume (Purge)
0.1-1200 ml/h adjustable
Bolus: adjustable 0.1-1200 ml/h
0.1-1000 ml
Alarm features
Occlusion, K.V.O. (infusion completion), standby, near empty, low battery, device malfunction (CPU error), clamp/handle lever/slider disengaged, syringe disengaged.
Special features
Keypad lock, shortcut key, retain memory, remaining time, alarm repeat, open system, K.V.O., purge, bolus, anti bolus, occ. level, history call-back.

Power
AC 230V, 50/60Hz and DC9.6V inner source adapter DC 12 / 24V - 2A Switchable at 110V / 60Hz - with adapter 35204
Maximum power consumption 45VA
Electric protection levels
Class II B, inner source device, CF type
Waterproof level IPX2
Battery type Ni-MH rechargeable
Battery using time 2 hours
Battery recharging time Minimum 6 hrs.
Battery life about 6 months.

CALIBRATION TO ANY SYRINGE BRAND
Please send 5 samples of your syringe.
Delivery in 60 days

IV clamp included

Colour display



English and Italian manual

Automatic set-up system (flow rate, time, delivery volume)

Easy and quick installation of syringe, just in five seconds



* We can calibrate our pumps for other syringe brands, please provide minimum 5 samples. Availability in 60 days.

PLASTER COVER FOOTWEAR

code	PLASTER COVER EU SIZE
28630	N 36
28631	N 37
28632	N 38
28633	N 39
28634	N 40
28635	N 41
28636	N 42
28637	N 43
28638	N 44
28639	N 45
28640	N 46
28641	N 47/48



Upper made of biocompatible synthetic materials mold resistant and breathable

Non-slip rubber sole

Cover plaster footwear to be worn over plaster or similar rigid bandage.

It can be worn immediately after application of the plaster because breathable.

The sizes are the same as for standard shoes, with appropriately increased fit.

The shape is symmetrical, then the same cover can be used indifferently on the right or left foot. Washable at 30°.

ORTHOPEDIC SUPPORTS



Wrist support Elbow support Knee support Ankle support

Elastic knitting supports to fit body contour. Gel pad inside to release pressure for nerves, muscle, joints and improve stabilization. Hand washable.

Size	WRIST		ELBOW	KNEE	ANKLE	
	Left	Right			Left	Right
S	28731	28741	28751	28761	28771	28781
circumference	15-16 cm		21-23 cm	28-31 cm	19-21 cm	
M	28732	28742	28752	28762	28772	28782
circumference	16-17 cm		23-25 cm	31-34 cm	21-23 cm	
L	28733	28743	28753	28763	28773	28783
circumference	17-18 cm		25-27 cm	34-37 cm	23-25 cm	
XL	28734	28744	28754	28764	28774	28784
circumference	18-19 cm		27-29 cm	37-40 cm	25-27 cm	

ARM SLINGS



Suitable for supporting a sprained or broken arm during recuperation. The shoulder strap is adjustable to allow a correct positioning of the arm. Stitched from cotton fabric requiring normal laundry care. Fits any arm. Available in 3 sizes.

code	POUCH ARM SLINGS
28624	Arm sling - small
28625	Arm sling - medium
28626	Arm sling - large

UNIVERSAL ARM SLINGS



• 28623 UNIVERSAL ARM SLING
Universal arm sling with adjustable strap and loop contact closure. Fits left and right. Made in comfortable polypropylene material in navy colour. Machine washable.

SOFT AND RIGID COLLARS

SOFT CERVICAL COLLARS

This collar is made of soft expanded polyurethane lined with an anti - allergic 100% cotton fabric. Velcro fixing on the back. Available in 3 sizes.

RIGID CERVICAL COLLARS

Made of polyethylene, with comfortable resting support in vinyl leather and height adjustable. Velcro straps on the back. Available in 3 sizes.

Soft

Rigid



code	SOFT AND RIGID NECK COLLARS X-Ray Translucent	CE
34600	Rigid cervical collar 32-40 cm (neck circumference)	
34601	Rigid cervical collar 41-46 cm (neck circumference)	
34602	Rigid cervical collar 47-52 cm (neck circumference)	
34610	Soft cervical collar 43x8 cm - small (h 7 cm)	
34612	Soft cervical collar 46x8 cm - medium (h 8.5 cm)	
34614	Soft cervical collar 49x10 cm - large (h 10.5 cm)	

UNIVERSAL COLLARS



UNIVERSAL CERVICAL COLLARS

Collars made of foam coated PVC. Washable, non toxic, with velcro straps. X-Ray translucent. Available in 3 sizes or in a set of 3 in a bag.

code	NECK COLLARS	A	B	C
34050	Set of 3 collars in a bag			
34051	Cervical collar - small	513 mm	87 mm	112 mm
34052	Cervical collar - medium	560 mm	95 mm	123 mm
34053	Cervical collar - large	623 mm	101 mm	132 mm
34054	Bag for 3 collars - blue			

AMBU® REDI-ACE™



Ambu® REDI-ACE™ Mini is adjustable in 6 sizes

34638



Ambu® REDI-ACE™ Adult is adjustable in 8 sizes

34639

AMBU® REDI-ACE™ COLLARS

Unique adjustable disposable collar available in 2 versions adult and pediatric for immobilizing of cervical column. With 8 sizes of Ambu® REDI-ACE™ and 6 sizes of Ambu® REDI-ACE™ Mini the majority of patients can be treated. Easy to use, it has an automatic flip up chin and two locking buttons. It can be placed on the patient using only 3 steps; sizing - locking - placement. Made from radiotranslucent material. Packaged completely flat. Latex free.

code	ADJUSTABLE NECK COLLARS
34638	Ambu® REDI-ACE™ paed.-yellow
34639	Ambu® REDI-ACE™ adult-blue

AMBU® PERFIT™



Ambu® Mini Perfit™ ACE® is adjustable in 12 sizes

34640



Ambu® Perfit™ ACE® is adjustable in 16 settings from neckless (size 3) to tall (size 6)

34641

AMBU® PERFIT™ ACE® COLLARS

The Ambu® Perfit™ ACE® extrication collar is a one-piece rigid cervical spine immobilization device, available in 2 versions, adult and pediatric, both adjustable in different sizes/positions. Adult has 16 adjustments, covering neckless, short, regular and tall. Paediatric has 12 adjustments, covering infant, child, small adult. Radiotranslucent CT and MRI compatible it comes with a ventilated, posterior shell for fluid drainage. Made in polyethylene. Flat storage. Latex free.

code	ADJUSTABLE NECK COLLARS
34640	Ambu® Perfit™ paediatric-yellow
34641	Ambu® Perfit™ adult-white

PERFIT™ MILITARY

Designed to assist with the maintenance of neutral alignment, prevention of lateral sway and anterior-posterior flexion and extension of the cervical spine during transport.



Ambu® Perfit™ ACE® Militar extrication collar is adjustable in 16 settings

34642

Flat storage



AMBU® PERFIT™ ACE® MILITARY

Ambu® Perfit™ ACE® is also available in a military version that incorporates a camouflage colour scheme of olive drab body and charcoal black foam and label. The features and specifications are identical to Ambu® Perfit™ ACE®:

- 16 sizes in one collar
- flat storage
- radiotranslucent CT and MRI compatible
- Latex free.

code	ADJUSTABLE NECK COLLARS
34642	Ambu® Perfit™ Military

FIRST AID CERVICAL COLLARS



34622



ONE PIECE AND TWO PIECES FIRST AID COLLAR

Made in polyethylene with washable internal part made in EVA (kind of rubber) fixed to structure by plastic rivets. With a tracheal hole, removable chin support and velcro fastener. X-ray translucent. Available in 6 sizes differentiated by safety closure colour or in a set of 6 in a bag.

code	ONE PIECE FIRST AID NECK COLLARS
34620	Infant 44-48 cm - pink
34621	Pediatric 45-48 cm - light blue
34622	Stout (bull-neck) 56-60 cm - yellow
34623	Adult small 56-62 cm - blue
34624	Adult medium 56-64 cm - orange
34625	Adult large - tall 56-66 cm - green
34626	Set of 6 collars in a bag
34627	Bag for 6 collars - green

code	TWO PIECES FIRST AID NECK COLLARS
34630	Infant 2-6 years 35-99 cm - pink
34631	Pediatric 6-12 years 40-46 cm - light blue
34632	Stout (bull neck) 48-52 cm - yellow
34633	Adult small 50-54 cm - blue
34634	Adult medium 54-58 cm - orange
34635	Adult large - tall 56-60 cm - green
34636	Set of 6 collars in a bag
34627	Bag for 6 collars - green

AIR CUSHION SPLINTS



• **34106 FIRST AID AIR CUSHION SPLINTS** - set of 4 pieces
 Indispensable instrument for first aid in case of accidents, cutting and crushing injuries. Prevent surface bleeding without stopping the circulation and secure painless transportation of the injured part. The bandage is a transparent cover of PVC easy to clean and reusable, resistant against water and shifting weather conditions. X-rays can penetrate and medical diagnosis can be made without removing the bandage. The long tube (14.5 cm) with the valve make the inflation of the bandage easy, even by the injured part himself.

Set of 4 different pieces: full leg, foot/ankle, full arm, hand/wrist splints in a 4 compartment bag, with inflating pump.

ALUMINIUM SPLINTS soft lining

With curved edges to avoid harming yourselves. Aluminium thickness 1.2 mm. Made in Italy.

- 34120 SPLINTS - size 13x500 mm
- 34121 SPLINTS - size 19x500 mm
- 34122 SPLINTS - size 24x500 mm



BOSTON SPLINTS



• 34123 BOSTON SPLINTS

Adaptable light-weight splints, x-ray translucent, coated with a non-toxic material which can be easily washed and disinfected. Size cm 92x11. Made in Italy.

FINGER SPLINTS

FINGER Set of 8 finger splints in different size (from 5 to 6.5 cm length, from 4.5 to 7.8 cm width circumference). Available in clear and skin tone colours. Made in polypropylene. With holes for air circulation and cooling.

- 34113 FINGER SPLINT KIT - clear - kit of 8
- 34115 FINGER SPLINT KIT - skin - kit of 8



GIMASPLINTS IN 5 SIZES: LEG, ARM, FOREARM, WRIST AND ELBOW

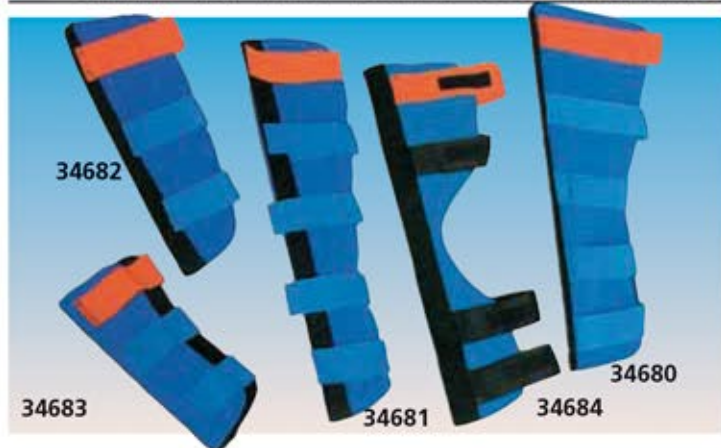

GIMASPLINTS these supports immobilize your limbs in an efficient and practical way. Each splint can be shaped to fit the patient's personal need. It ensures a high degree of rigid support: thanks to inner part made of neoprene lined with 100% laminated, absorbent-proof nylon assembled to a rigid metal splint. A velcro band allows a quick fixing. Available in 5 sizes or in a bag set of 5 pieces.

code	GIMASPLINTS
34680	Splint for leg - 57 cm
34681	Splint for arm - 60 cm
34682	Splint for forearm - 39 cm
34683	Splint for wrist - 33 cm
34684	Splint for elbow/ankle - 54 cm
34685	Set of 5 splints in a blue bag
34054	Bag for 5 splints - blue



VACUUM SPLINT KIT

• 34689 VACUUM SPLINT KIT

The set includes vacuum splints for arm (70x50 cm), leg (100x70 cm) forearm (50x30 cm) and a nylon bag. Produced with high quality materials these splints allow perfect immobilization of the lower and upper limbs by removing the air inside.

Equipped with an outside valve, to avoid troubles to the patient, and three velcro straps.

Made in vinyl covered nylon, x-ray translucent.

- 34093 ALUMINIUM PUMP - for vacuum splints and mattress
- 34084 ALUMINIUM MINI PUMP



VACUUM MATTRESS

• 34089 MAT PLUS VACUUM MATTRESS

PVC, X-ray translucent mattress provided with 4 immobilization straps and 12 transport holes. Suitable for any kind of emergency situation. Size: 210x90 cm. Weight: 11.2 kg. Loading capacity: 150 kg. Supplied with nylon bag size 86x43x17 cm, pump not included.



34089



Nylon carrying bag included with all vacuum mattresses



34093

• 34093 ALUMINIUM PUMP for vacuum mattress

Capacity: 0.75 l
Supplied with hose and fitting. Rotating handle.



34088

• 34088 MAT VACUUM MATTRESS

PVC, X-ray translucent mattress with 6 transport handles, perfectly fits the patient body. Sturdy material and careful manufacture make it suitable for Civil Defence, Fire Brigades, Industry and First-aid on the mountains. Size: 200x75 cm. Weight: 8.8 kg. Loading capacity: 150 kg. Supplied with nylon bag size 70x43x15 cm, pump not included.



34091

• 34091 MAT ORANGE VACUUM MATTRESS

X-ray translucent, comfortable vacuum mattress with 8 transport handles and 4 immobilization straps. Size: 210x90 cm. Weight: 9 kg. Loading capacity: 150 kg. Supplied with nylon bag size 86x43x15 cm, pump not included.

SEMIRIGID SPLINT KIT

• 34119 SEMIRIGID SPLINT KIT

Kit of 3 splints (arm, wrist, leg) in nylon carrying bag. All splints are made of polyester + PVC, with lightweight stays providing high strength support. Adjustable velcro for easy use.



34119

EXTRICATION KITS



34028

34027

Provide horizontal flexibility and vertical rigidity support

• 34027 SPINAL IMMOBILIZER TYPE A
• 34028 SPINAL IMMOBILIZER TYPE B
GIMA presents 2 different shape of spinal immobilizers, both are ideal for the immobilization and setting free of patients from emergency situations. They allow to fix vertically and horizontally the head and spine of the patient to limit any injuries caused by wrong transport. Supplied with different colour buckles and belt for easy use, padded cushion velcro straps and waterproof bag.

BODY BAGS



• 34116 BODY BAG - PVC

Made of PVC (Inner transparent PVC, over black), provided with two long slide fasteners. Colour: black. Size: 210x90 cm. Loading capacity: 150 kg.



• 34117 BODY BAG - vinyl - blue

Made of vinyl covered nylon conform to standard EN 1865. Provided with a long slide fastener. Size: 210x90 cm. Loading capacity: 150 kg.

CARRYING COT

Multilanguage manual:
GB, FR, IT, ES,
PT, DE

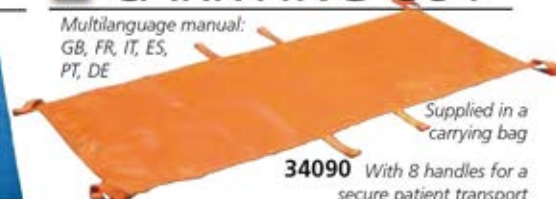

34090

Supplied in a carrying bag
With 8 handles for a secure patient transport

• 34090 CARRYING COT

Made in polyester, PVC coated. Anti-putridity, bacterial and fungus proof, waterproof, easy to wash and disinfect, X-ray translucent material. Size 185x57 cm. Loading capacity: 150 kg. Certified EN1865-2010 + A1 2015

GIMA STRETCHERS AND SPINAL BOARDS



• **34101 GIMA STRETCHER 2 - foldable in 2**
Emergency stretcher is sturdy, but lightweight in construction, with aluminium frame and three solid iron cross-bars for heavy use. Reinforced nylon canvas, fluid repellent and non-tear.



34101

Supplied with carrying bag

• **34107 GIMA STRETCHER 4 - foldable in 4**
Made of strong alloy and water-tight material. Light weight, easy to carry, foldable in 4. Length foldable in 2 parts, width foldable in 2 parts.



34107

• **34105 STACKABLE STRETCHER**
Used in small rooms where it is necessary to store a large number of stretchers. PVC does not absorb blood or body fluids. Strong lightweight aluminium construction with vinyl coated polyester



34076

• **34076 BLUE STRETCHER - foldable in 2**
Light-weight, small sized, easy to carry. High-strength aluminium poles and vinyl coated waterproof nylon canvas.



34077

• **34077 WHEEL STRETCHER - foldable in 2**
Wheels, outriggers and adjustable backrest. High strength aluminium poles and vinyl coated, waterproof nylon canvas. Light weight, small sized, easy to carry.

• **34083 SPINAL BOARD**
X-ray translucent, washable, buoyant and impervious to all fluids. Made in linear high density polyethylene with plastic pins. Compatible with all head-immobilization devices and strapping system. CT and MRI transparent. Colour orange.

• **34022 B-BAK PIN SPINAL BOARD - yellow**
PE spinal board with Pin with robust and light structure to ensure high resistance. The 14 handles and their shape offer an easy grip, the low thickness make the application easier. Equipped with 8 plastic pins to allow easy fixing of belts with snap hook.

• **34097 SPINAL BOARD WITH SAFETY GLASS FIBRE PINS - orange**
Strong and lightweight high density PE spinal board, with two fibre reinforced plastic stays. Provided with glass fibre pins for better fixation of immobilisation belts. Excellent in water rescues. X-ray translucent, except 2 plastic stays.



Glass fibre pins



2 fibre reinforced plastic stays

• **34023 BABY GO PEDIATRIC SPINAL BOARD**
Baby go is a professional board, designed for children, which maintains the spine in neutral position with the ideal alignment for air flow. Board has four different profiles which guarantee the correct position of the child according to his body size.

• **34024 PEDIATRIC HEAD IMMOBILIZER**
Ensure optimal immobilization of the head of children perfectly fitting their pronounced occipital prominence.

• **34025 PEDIATRIC SPIDER STRAP SYSTEM**



34025

The central tape can be used as a tape measure

TECHNICAL SPECIFICATIONS	34101	34107	34105	34076	34077	34083	34022	34097	34023
	GIMA 2	GIMA 4	STACKABLE	BLUE	WHEEL	SPINAL	SPINAL WITH PINS	SPINAL WITH PINS	PAED SPINAL
Open size cm:	203x50x14	221x53x16	188x48x18	188x45x7	188x53x21	184x44.5x6.5	184x40.5x4.5	183x46x5	119.5x32x4.5
Folded size cm:	96x50x17	104x19x12	-	94x48x10	92x53x12	-	-	-	-
Weight:	6 kg	5 kg	6 kg	4 kg	8 kg	7.6 kg	6 kg	7 kg	2.2 kg
Load:	120 kg	150 kg	170 kg	150 kg	150 kg	150 kg	180 kg	200 kg	30 kg

SCOOPIING STRETCHER



34103

Supplied with multilanguage manual:
GB, FR, IT, ES, PT, DE

• 34103 SCOOPIING STRETCHER

A wonderfully practical scooping stretcher allows to put the stretcher under the patient without moving him/her much. The shape of the stretcher has been designed to immobilize the patient properly during transport.

- effective hooking and unhooking device for stretcher uncoupling
- adjustable stretcher length with automatic locking device
- bag with 3 quick unhooking safety belts for patient immobilization
- once folded can be easily stored inside the ambulance
- completely built in light and sturdy aluminium

TECHNICAL SPECIFICATIONS

Open size cm:	min 171x43	max 212x43
Folded size cm:	120x43	
Weight:	8 kg	
Load:	150 kg	

HEAD IMMobilIZERS



34020



34021



34078



34079

Radiolucent material,
suitable for x-ray chamber

HEAD IMMobilIZERS
GIMA introduces four models of head immobilizers, different in shape, material and colour. All are composed of two head blocks and two straps to prevent any head movement of the injured person during transport. We can offer "STOP" head immobilizer in yellow, blue, red, green, military green for minimum 50 pieces.



34021

code	Type	Colour	Material
34020	FERMO-1	yellow	PE foam covered with PVC
34021	FERMO-2	red	NBR foam dipped with PVC
34080	STOP	orange	High density foam+water repellent coating
34078	STOP	black	High density foam+water repellent coating
34079	CONTOUR	yellow	Moulded polyurethane and PVC

IMMobilISATION BELTS FOR STRETCHERS AND SPINAL BOARDS



34010



Adjustable belt

34011



Set of 3 adjustable belts with pouch

34014



Set of 3 belts with pouch

34015



34012



34013



34081

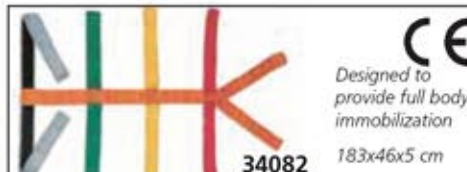

34082

Designed to provide full body immobilization
183x46x5 cm



34018

Spider strap adjustable in different sizes for child and adult
203x51x5 cm

code	Type	Colour	Size cm	Max load kg	Buckle style	To be used with
34010	Belt-A	red	5x213	60	plastic snap-lock	stretchers + boards
34011	Belt-B - adjust.	black	5x213	60	2 swivel speed clip + plastic snap-lock	spinal boards with pin
34012	Belt-C	red	5x213	200	automatic quick release (unique belt)	stretchers + boards
34013	Belt-D	black	5x213	200	automatic quick release (belt in 2 pcs.)	stretchers + boards
34014	Set 3 belt-B	orange	5x274	60	2 swivel speed clip + plastic snap-lock	spinal boards
34015	Set 3 belt-D	yellow	5x213	200	2 swivel speed clip (belt in 2 pcs.)	stretchers + boards
34081	Set 3 Belts	orange	-	-	quick release plastic hook	stretchers + boards
34082	Ragno/Spider	mix	5x46x183	-	velcro strapping system	spinal boards
34018	Adjustable spider	mix	5x51x203	-	velcro strapping system - adjustable	spinal boards
32794	Nylon bag	red	-	-	-	contains up to 3 belts

AUTOMATIC LOADING STRETCHER



• 34055 AUTOMATIC LOADING STRETCHER

Automatic stretcher to load and unload patients from emergency vehicles, can be moved by only one person. Specially designed with roll-in system to easily load and unload patients from emergency vehicle without lifting them. Legs fold under cot automatically as stretcher is rolled into the vehicle. Lock-in operating position as cot is removed from vehicle, left-hand and right-hand control levers unlock front and back legs respectively so as to be folded when cot is loaded. Polyethylene covered legs allow cot to roll smoothly in and out of vehicle. Mattress, belts, side rails, IV stand and fixing devices are included.

TECHNICAL SPECIFICATIONS

Maximum size (LxWxH):	193x60x88 cm
Minimum size (LxWxH):	193x60x21 cm
Packing size:	195x61x26 cm
Weight:	40 kg
Load:	159 kg



Fixing device in vehicle

MULTIPOSITION STRETCHER



• 34056 MULTIPOSITION AUTO STRETCHER

Multifunctional automatic stretcher for ambulance with easily adjustable positioning system, for any emergency situation. The stretcher can bend through 6 different grades, forwards or backwards. The back of the stretcher is fixed by pneumatic springs moving in the range of 0 to 60 degrees, also equipped by front and back fixed supports. It can be locked into place inside ambulance at proper position. Mattress, belts, side rails, I.V. stand and fixing devices are included.



TECHNICAL SPECIFICATIONS

Maximum size (LxWxH):	198x53x93 cm
Minimum size (LxWxH):	198x53x34 cm
Packing size:	200x60x35 cm
Load:	159 kg
Net weight, Gross weight:	35 kg, 40 kg
Maximum angle of leaning forwards:	11 degrees
Maximum angle of leaning backwards:	25 degrees
The height scope of touching down (6 grades):	98 cm - 94 cm - 87 cm 77 cm - 60 cm - 34 cm



Fixing device

AUTOMATIC MULTIPosition STRETCHER



• 34072 FULL AUTOMATIC MULTIPosition STRETCHER

Full automatic multiposition stretcher. Easily adjustable to 6 levels for any emergency situation. Back wards and forwards reclining, back and foot rest adjustable to different positions. Can be loaded into ambulance by one operator only and locked at desired position. Structure in high-strength aluminium alloy. Soft foam surface mattress, covered by special seamless welded PVC. Protective block side rust proof and easy to clean. Mattress, belt, side rails, IV stand and fixing device are included.

TECHNICAL SPECIFICATIONS

Maximum size (LxWxH):	198x54x93 cm
Minimum size (LxWxH):	198x54x30 cm
Packing size:	218x67x35 cm
Load:	159 kg
Net weight, Gross weight:	39 kg, 45 kg



WHEELCHAIR STRETCHER



• 34070 WHEELCHAIR STRETCHER

Wheelchair stretcher with varied positions. Lightweight emergency cot quickly convert to any of four chair positions for maneuvering in narrow hallways, elevators and other confined spaces. Stretcher is made in high quality aluminium alloy. Soft foam mattress and protective block side, rust proof and easy to clean. Mattress, belts, side rails, IV stand and fixing device are included.

TECHNICAL SPECIFICATIONS

Size (LxWxH):	190x57x85 cm
Packing size:	198x60x25 cm
Load:	159 kg
Net weight, Gross weight:	32 kg, 40 kg



Fixing device



BASKET STRETCHER

- 34094 TWIN SHELL BASKET STRETCHER - orange
- 34098 BASKET STRETCHER - orange

Robust, resistant and flexible, it is ideal for a wide range of rescue operations in mines, at altitude and in water. A revolutionary production technique ensures uniform thickness of the entire length of the stretcher. The shell is in high-density polyethylene and is joined to an aluminium framework for better strength. The handles for transport, integrated in the structure, are placed along the entire perimeter. The grommets for the fixing of the spring catches of the harnessing are in stainless steel. Inside the shell there is a removable mattress, applied with Velcro®, made in closed-cell EPDM, which makes it impermeable to both blood and water. High density polyethylene guarantees shatterproofness and sanitization. It can contain a spine board. Comes with nylon rope along entire perimeter, three 50 mm nylon belts with quick-release buckles, water resistant and closed-cell mattress, footrest in pre-formed polyethylene with position regulator.

Twin shell basket stretcher

It can be transversally divided in half to improve the storage and transport. To ensure a perfect hold between the two shells, have been inserted four nylon cones and a security system protected by a protuberance placed in the mould itself.

- 34099 LIFTING BRIDLES

Adjustable, can be used for horizontal and vertical patient lifting. Manufactured in durable woven nylon with sound steel attachment hardware and brass locking mechanism.

- 34100 FLOTATION SYSTEM
- 34096 CARRYING BAG for 34094



34098

TECHNICAL SPECIFICATIONS

	34098	34094
Size (LxWxH):	215x65x19 cm	118/215x64x19 cm
Load capacity:	280 kg	280 kg
Weight:	13.5 kg	17 kg

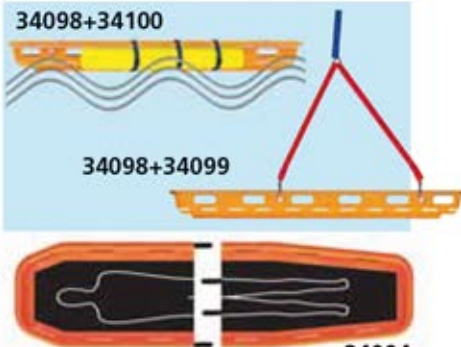

34098+34100

34098+34099

34094

WHEELCHAIR STRETCHERS

- 34060 WHEELCHAIR STRETCHER - 2 wheels
- 34074 WHEELCHAIR STRETCHER - 4 wheels

Specially designed for confined areas such as narrow hallways or multiple landing stairways; anywhere access is seriously limited. Made in light aluminium with waterproof orange sheet. Two rear stationary wheels Ø 12 cm (34060) or 4 wheels, 2 with brake (34074) two back handles and four front handles, 2 adjustable 30 cm, facilitate transport on most floor types. 2 quick lock safety belts immobilize patient during transport. Locking safety latch maintains chair position during use.

TECHNICAL SPECIFICATIONS

Folded size:	91x52x19.5 cm	Open size:	91x52x71 cm
Wheelchair size:	- back height: 91 cm - width: 52 cm		
	- seat height: 48 cm - width: 52 cm		
Loading:	150 kg	Weight:	8.5 kg

Foldable down handle

Foldable up handle

CE



34060

34074

34060

Adjustable handle (+30 cm)

FOLDING STAIR CHAIR AND EVACUATION CHAIR

- 34058 EVACUATION CHAIR - orange/chrome

Designed and built for emergency patient removal from confined spaces. Folded it can be stored in most ambulances. Manufactured from chromed steel with brakes on the front wheels.

Seat cover made of vinyl coated nylon, easily washable. Folds in one movement, equipped with two quick-release patient restraints.

- 34059 FOLDING CHAIR - black/yellow (orange/chrome on request)

A cost effective choice for moving patients through difficult situations. Four non-slip grip handles make lifting the patient safer and easier.

Two large rear wheels provide easy manoeuvring. Tough, black, vinyl coated seat cover easy to clean, resists stain and provides bacteriostatic protection.

Supplied with a set of 3 plastic buckle belts. Made in Italy

- 34061 SKID EVACUATION CHAIR - with braking slide

Skid-Ok a new ultra compact evacuation chair with innovative aluminium frame and tubular trellis swing fork.

New concept materials and components make the chair lightweight and easy to manoeuvre to offer top performance in any scenario.

Reclining armrests to increase patient comfort. The innovative self braking slide system offers the operator total control during the stair descent.

Manufactured in welded aluminium with polished finish.

Adjustable seat strengthened with Spentex®.

Skid-OK is supplied with 2x50 mm polypropylene belts. Made in Italy.

TECHNICAL SPECIFICATIONS

	34059	34058	34061
	FOLDING	EVACUATION	SKID
Height (open/closed):	92 cm	98/78 cm	154/104 cm
Width:	48 cm	41 cm	52 cm
Depth with retracted handles:	59 cm	-	-
Depth with extended handles:	125 cm	open 80 cm	-
Depth when folded handles:	19 cm	closed 31 cm	-
Weight:	10 kg	12 kg	11 kg
Load:	165 kg	116 kg	150 kg

CE

34058

Height open/closed 154/104 cm

Pivoting front wheels

34061

34059

SMART OXYGEN CONCENTRATOR

- **34598 SMART OXYGEN CONCENTRATOR 5 l**
Medical grade, ultra quiet, small oxygen concentrator for home use. Provide high concentration of oxygen through nasal cannula. Work continuously.
- **34599 PAPER FILTER - box of 10**
- **34608 HUMIDIFIER BOTTLE**
- **34167 OXYGEN MASK with tube - pediatric**
- **34166 OXYGEN MASK with tube - adult**
- **34172 OXY GLASSES - nasal cannulas**

TECHNICAL SPECIFICATIONS	
Flow range:	0.5 ~ 5 l/min
Oxygen concentration:	95.5-87 %
Output pressure:	40 ~ 70 kPa
Input power:	400 W
Operation noise level:	≤ 48 dB (front) - ≤ 52 dB (whole unit)
Size - weight:	39x24x50 cm - 16 kg
Operating voltage:	230 V - 50 Hz (110 V - 60 Hz on request)

Supplied with filter and nebulizer set



OXYGEN CONCENTRATORS 3 AND 5 LITRES

- **34604 OXYGEN CONCENTRATOR 3 l**
- **34605 OXYGEN CONCENTRATOR 5 l - with nebulizing function**
Bionic and streamlined fashion design, which won the national outlook top award-Red Star Award. Low noise achieved by using advanced round airway and multi-level noise decreasing design. Large LCD screen for clearer figures. Cumulative time metering and timing off function. Fault self-detection system.

Four alarm functions:
 - power failure alarm - low oxygen concentration alarm
 - pressure cycle failure alarm - compressor failure alarm

Nebulizing function (only 34605)

Oxygen concentrator (with nebulizer function) uses the combination of oxygen uptake and atomization function to offer clean and safe air. It assists in atomized treatment while maintaining the same oxygen concentration.

- **34607 PAPER FILTER - box of 10 (5 internal + 5 external)**
- **34608 HUMIDIFIER BOTTLE**
- **34166 OXYGEN MASK with tube - adult**
- **34172 OXY GLASSES - nasal cannulas**
- **34167 OXYGEN MASK with tube - pediatric**

CE 0123

yuwell
 Top manufacturer
 over 200,000 pcs/years

Supplied with filter, nasal oxygen canula, nebulizer set (34605 only) and manual (GB, IT)



TECHNICAL SPECIFICATIONS		
	34604	34605
Flow range:	0.5 ~ 3 l/min	0.5 - 5 l/min
Oxygen concentration:	93% ± 3%	95.5% ~ 87%
Output pressure:	20 ~ 50 kPa	40 ~ 70 kPa
Operation noise level:	≤ 50 dB (A)	≤ 53 dB (A)
Input power:	320VA	400VA
Net/gross weight:	25/27 kg	
Packing size:	62x37x71 cm	
Operating voltage:	230 V - 50 Hz (on request 110 V - 60 Hz)	

OXYGEN CONCENTRATOR 3 AND 5 L DELUXE

- **34616 OXYGEN CONCENTRATOR 3 l DELUXE**
- **34617 OXYGEN CONCENTRATOR 5 l DELUXE**
Top of the range oxygen concentrator with innovative design and superior features:
 - backlit LCD screen with adjustable brightness
 - built-in oximeter for monitoring SpO₂ in real time
 - oil free pump: the heart of concentrator adopt compressor with German technology for 30,000 hours service life and 5 years warranty
 - high intake position, cleaner air
 - remote control function
 - 4 alarm system (low oxygen concentrator alarm, power outage alarm, pressure cycle failure alarm, compressor failure alarm), self detection of fault
 - 4 safety protections
- **34618 PAPER FILTER - box of 10**
- **34619 HUMIDIFIER BOTTLE**
- **34166 OXYGEN MASK with tube - adult**
- **34167 OXYGEN MASK with tube - pediatric**
- **34172 OXY GLASSES - nasal cannulas**

Manual: GB, IT.

yuwell

Backlit LCD screen with adjustable light

CE 0123

Nebulizer function

Built-in oximeter for real time detection

Supplied with filter, nasal oxygen canula, nebulizer set, remote control and manual (GB, IT)

Remote control

Compact and lightweight only 17.5 kg

TECHNICAL SPECIFICATIONS

	34616	34617
Flow range:	0.5 ~ 3 l/min	1 ~ 5 l/min
Oxygen concentration:	93% ± 3 %	87-95.5 %
Operation noise level:	≤ 46 dB(A)	≤ 49.5-52 dB(A)
Output pressure:	20 ~ 50 kPa	40 ~ 70 kPa
Input power:	320VA	400VA
Size - Packing size:	50x21x64 cm - 56x32x71.5 cm	
Operating voltage:	230 V - 50 Hz (110 V - 60 Hz on request)	



OXYGEN CYLINDERS: 0.5, 2, 3, 5 AND 7 LITRES



CYLINDERS FOR OXYGEN THERAPY (empty)
Steel cylinders for therapeutic oxygen at 200 bar pressure, with valve and safety lock. These cylinders are ideal for home and hospital therapeutic use, particularly in case of desultory oxygen supply. Supplied in a sturdy plastic bag (5 and 7 l) or soft bag (2 and 3 l) with cover. Oxygen cylinders are provided with a pressure reducer with two-stage release valve (0-15 l/min) and high pressure manometer to indicate oxygen quantity in the cylinder (Code 34510/34511) and face mask (excluding 34500/34520).

OXYGEN CYLINDERS WITH INTEGRATED PRESSURE REDUCER						
code	UNI	NF	Litres	Flow	Size	Weight kg
34500	34520*		0.5	fixed 6 l	Ø 60x400mm	2.75
34502	34522*		2	0/15 l	Ø110x410mm	4.5
34503	34523*		3	0/15 l	Ø110x530mm	5.5
34505	34525*		5	0/15 l	Ø140x550mm	9
34507	34527*		7	0/15 l	Ø140x680mm	11

PRESSURE REDUCER with valve 9 steps for flow adjustment

Pressure reducer with valve and index flowmeter adjustable 0-12 l/min, suitable for cylinders 1 to 3 litres (code 34510/34530) and 5 to 7 litres (34511/34531). It includes two stages, release valve and high pressure manometer.

Thread cylinder connection: E25/E17 conical refill thread connection

UNI 21.7 x 1/14" or NF Ø 22.91 x 1.514



0123

34510

Apparatus to be connected to a cylinder without valve.

UNI	NF	PRESSURE REDUCERS WITH VALVE - spare
34510	34530*	Integrated pressure reducer with valve for 2/3 litres
34511	34531*	Integrated pressure reducer with valve for 5/7 litres
34539		Cover protection for cylinders 2/3/5/7 litres



Oxygen therapy masks are produced with non toxic material, complete with adjustable elastic clip for nose and connecting tube

0086



OXYGEN THERAPY MASKS		
34166		Oxygen therapy mask - adult - with tube
34167		Oxygen therapy mask - paediatric - with tube
34168		HI-Oxygen therapy mask - adult - with tube
34169		HI-Oxygen therapy mask - paediatric - with tube
34276		Disposable oxy tube - 2m - female - female
34172		Oxy glasses - nasal cannulas

*Products not in stock, available in 15 days

GENERAL PURPOSE CYLINDERS 5 AND 10 l AND PRESSURE REDUCERS



GENERAL PURPOSE CYLINDERS (empty)
Supplied with valve. Ideal for anaesthesia apparatus, can be used with pressure reducer code 34540-34541 or other standards (NF, DIN, BRITISH STD or PIN INDEX).

code						OXYGEN CYLINDER WITH VALVE AND ACCESSORIES
UNI	NF	DIN	BULL NOSE BRITISH STD	PIN INDEX		
34545	34555*	34565*	34575*	34585*		Oxygen Cylinder 5 l with valve
34548	34558*	34568*	34578*	34588*		Oxygen Cylinder 10 l with valve
34540	34550*	34560*	34570*	34580*		Pressure reducer
34541	34551*	34561*	34571*	34581*		Pressure reducer with flowmeter and humidifier
34590	34590	34590	34590	34590		Humidifier autoclavable at 121°C

*Products not in stock, available in 15 days

PRESSURE REDUCER (34540, 34550, 34560, 34570, 34580)
Same as code 34541, with adjustable flow 0-15 l/m in 9 steps (1/1.5/2/3/4/6/9/12/15), LP* port, without flowmeter and humidifier.



PRESSURE REDUCER - WITH FLOWMETER AND HUMIDIFIER (34541, 34551, 34561, 34571, 34581)
Pressure reducer with release valve and H.P. manometer with adjustable ball flowmeter 0-15 l/min and autoclavable humidifier apparatus to be connected with cylinder valve.



- 34590 AUTOCLAVABLE HUMIDIFIER
- 34177 TROLLEY FOR OXYGEN CYLINDER - 5 l - 7 l
- 34178 TROLLEY FOR OXYGEN CYLINDER - 10 l

*Low pressure port (for ventilators,...)

AMBU® MARK IV RESUSCITATORS



• **34200 AMBU® MARK IV RESUSCITATOR - adult**
 Designed in accordance with the original double wall principle, the new 100% latex-free Ambu bags are more robust and provide users with exceptional visual and tactile lung condition feedback during manual resuscitation, making operation safer and more secure. Built-in pressure limitation prevents compression if there is any resistance in the patient's airways. Suitable for adults and children over 15 kg (3 years). Supplied with face mask N°5 and single shutter valve. Autoclavable at 134°C. Maximum volume 1300 ml.

• **34204 AMBU® MARK IV RESUSCITATOR - baby**
 Same as 34200, but suitable for neonates, infants and children up to 20 kg (approx 4-5 years). Supplied with face mask N°0A, oxygen reservoir tube 250 mm and pressure limiting valve 4.0 kPa (40 cm H₂O). Maximum volume 300 ml.

• **34217 AMBU MARK® IV RESUSCITATOR - adult with kit bag**
 Same as code 34200, supplied with helicoidal mouth-wedge, tongue holding forceps, 3 Guedel airways (small, medium and large) and oxygen tube, all fitted in a resistant nylon bag.



TRANSSPARENT

SILICONE AMBU FACE MASKS - Latex-free

The silicone face masks are self-inflating and the cuff pressure can be regulated for an easy and efficient seal. They are comfortable to grip and feature a thumb rest so rescuers can achieve a tight seal. Visual checks of bleeding, vomitus and spontaneous breathing can be made through the transparent dome. Autoclavable at 134°C

code	AMBU TRANSPARENT LATEX-FREE FACE MASKS AND RESERVOIR
34210	Ambu Baby N° 0A - newborns/prematures - blue
34205	Ambu Baby N° 0 - newborns/children - blue
34206	Ambu N° 2 - boys - blue
34207	Ambu N° 3/4 - adults/small - blue
34208	Ambu N° 5 - adults - blue
34209	Ambu N° 6 - adults/large - blue
34215	Reservoir bag 1500 ml - adult



GIMA RESUSCITATORS - DOUBLE CHAMBER, WITH QUALITY MASK

GIMA RESUSCITATOR BAG - with double chamber

Highly professional resuscitator bag with an antistatic autoclavable and self expanding rubber internal bag and with extra soft external bag.

Available in 2 models: adult and infant.

All models are equipped with connections in accordance with EN 1281-1 directives for peep valve, intubation fitting, oxygen reservoir, oxygen intake and face masks.

Radiotransparent and latex free

All equipped with removable and autoclavable valve.

Made in Italy.

• **34240 RESUSCITATOR BAG - adult**

Supplied with facemask N° 4 - volume 1900 cc

• **34241 RESUSCITATOR BAG - with kit bag**

Same as 34240 supplied with helicoidal mouth-wedge, tongue holding forceps, 3 Guedel airways (small, medium and large) and oxygen tube, all fitted in a resistant nylon bag.



• **34242 RESUSCITATOR BAG - infant**

Supplied with facemask N° 2 - volume 400 cc



GIMA RESUSCITATORS WITH DOUBLE STAGE VALVE



34231
Resuscitator with
kit bag and
facemask N° 4

GIMA RESUSCITATOR BAGS

The line offers 3 models of different size: adults, children, infants and an adult kit. All models are supplied with pressure relief valve and equipped with connector under EN 1281-1 directive for: peep valve, intubation fitting, reservoir, oxygen intake, face mask. Each resuscitator can be completely disassembled for cleaning and sterilization. Made in Italy. Autoclavable at 121°C max 20 times.

- **34230 RESUSCITATOR BAG - with mask N°4 - adult**
With a special double stage valve at 54 m/bar. Volume 1800 cc.
- **34233 RESUSCITATOR BAG - with mask N°3 child**
With a special double stage valve at 54 m/bar. Volume 800 cc.
- **34232 RESUSCITATOR BAG - with mask N°2 - infant/newborn**
With a special double stage valve at 54 m/bar. Volume 400 cc.
- **34231 RESUSCITATOR BAG - adult with kit bag**
Same characteristic as code 34230. It is supplied with helicoidal mouth-wedge, tongue holding forceps, 3 Guedel airways (small, medium and large) oxygen tube, in a nylon bag.
- **34271 NYLON BAG - 18.5x15xh 30 cm - spare**

Double side overpressure valve at 54 m/bar avoids inconvenients in case of a regurgitation due to the presence of food in the stomach of the patient

Size 330 x Ø120 mm
Capacity = 1,800 cc



34232 Pediatric resuscitator with child facemask N° 2



34230

SILICONE TRANSPARENT AUTOCLAVABLE RESUSCITATORS

SILICONE RESUSCITATORS - latex free

Transparent resuscitators made of silicone and polysulfone fully autoclavable at 134°C.

- **34244 SILICONE RESUSCITATOR KIT - adult**
Supplied with silicone face mask N° 4, 60 cm H₂O pop-off valve, oxygen tube 2 metres, autoclavable reservoir valve and 2500 ml reservoir bag. Volume: 1,600 ml.
 - **34245 SILICONE RESUSCITATOR - adult**
Supplied with silicone face mask N° 4. Volume: 1600 ml.
 - **34246 SILICONE RESUSCITATOR - child**
Supplied with silicone face mask N° 3 and 40 cm H₂O pop-off valve. Volume: 500 ml.
 - **34247 SILICONE RESUSCITATOR - infant**
Supplied with silicone face mask N° 1 and 40 cm H₂O pop-off valve. Volume: 280 ml.
- All silicone resuscitator have multilanguage manual:
GB, FR, IT, ES, PT



34244



34246



34247

- **34243 SILICONE RESUSCITATOR BAG KIT - adult**
Supplied with silicone face mask N° 4, 60 cm H₂O pop-off valve, oxygen tube 2 metres, autoclavable reservoir valve and 2,500 ml reservoir bag (volume: 1,600 ml), helicoidal mouth wedge (34273), tongue holding forceps, 10 Guedel airways (34439) with Cubo emergency bag (27163).



34243

AMBU® SPUR II RESUSCITATOR - THE NEXT GENERATION

AMBU SPUR II RESUSCITATOR - single patient

Ambu SPUR II provides users with exceptional tactile and visual feedback during resuscitation. The bag is highly responsive, with minimal mechanical resistance. Furthermore the characteristic design provides optimum stroke volume with perfect recoil. Range includes infant, pediatric, and adult sizes. All Ambu SPUR II resuscitators come in individual, resealable plastic carrying bags, complete with mask, reservoir bag (34235, 34236 only) oxygen tube and pressure limiting valve 4.0 kPa H₂O (34236/7 only). The bags are color-coded for fast identification of infant, pediatric, and adult sizes.

- 34235 AMBU SPUR II ADULT - with face mask n° 5 and reservoir bag
- 34236 AMBU SPUR II PEDIATRIC - with face mask n°1 and reservoir bag
- 34237 AMBU SPUR II INFANT - with face mask n° 0

		34235	34236	34237
Suitable for		adult > 30 kg	baby 10 to 30 kg	infant < 10 kg
Stroke volume	1 hand	800 ml	450 ml	150 ml
	2 hand	1,000 ml		
Resuscitator volume		1,475 ml	635 ml	220 ml
Size (Length x diameter)		295x127 mm	234x99 mm	168x71 mm
Bag reservoir volume		2600 ml	1500 ml	-

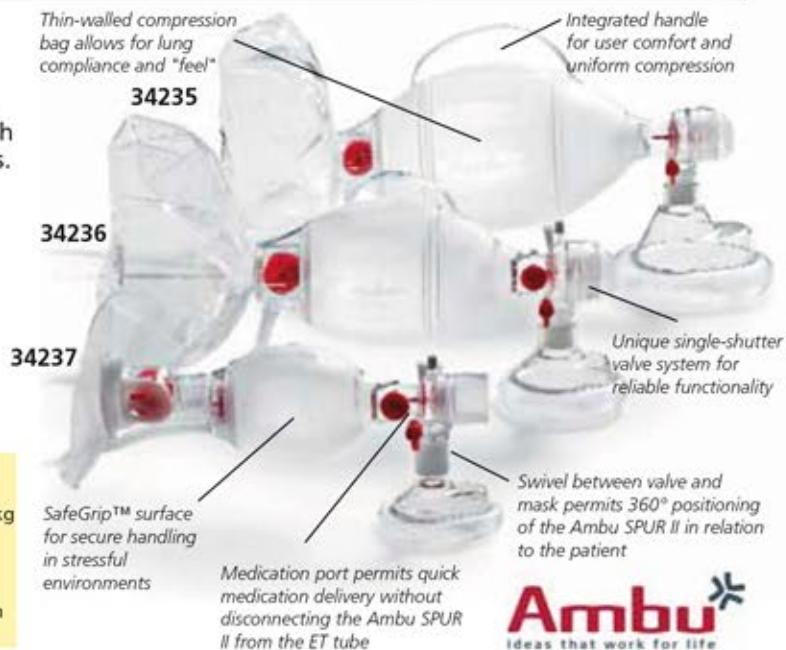

Ambu
Ideas that work for life

RESUSCITATOR BAGS SINGLE-USE, SINGLE PATIENT - LATEX FREE

PVC RESUSCITATORS - SINGLE PATIENT USE

Disposable resuscitator bags with disposable mask, no return membrane valve and connection for PEEP valve.

PVC disposable, transparent mask shaped to allow a perfect adhesion to the patient's face. Latex free.

- 34277 PVC RESUSCITATOR - adult
Supplied with single use mask N° 5. Volume: 1,600 ml



- 34248 PVC RESUSCITATOR - child
Supplied with single use mask N° 3 and 40 cm H₂O pop-off valve. Volume: 500 ml

- 34249 PVC RESUSCITATOR - infant
Supplied with single use mask N° 1 and 40 cm H₂O Pop-off valve - Volume: 280 ml

- 34239 PVC RESUSCITATOR KIT - adult
Same as code 34277. Supplied with oxygen reservoir 2,500 ml, tongue holding forceps and oxygen tube in a nylon bag.



GUEDEL AIRWAYS

STERILE AND NON STERILE GUEDEL AIRWAYS

Guedel airways in 9 sizes with smooth surface and round tip for improved patient comfort.

Made in polyethylene (PE). Latex free.

code	GUEDEL AIRWAYS - STERILE FLEXIBLE, TRANSPARENT, INDIVIDUALLY PACKED GUEDEL AIRWAYS	Minimum order
34431●	Guedel airway 40 mm - pink - newborn - 000	box of 10
34432●	Guedel airway 50 mm - blue - newborn - 00	box of 10
34433●	Guedel airway 60 mm - black - child - 0	box of 10
34434▲	Guedel airway 70 mm - white - boy - 1	box of 10
34435▲	Guedel airway 80 mm - green - adult/small - 2	box of 10
34436●	Guedel airway 90 mm - yellow - adult/small - 3	box of 10
34437●	Guedel airway 100 mm - red - adult/medium - 4	box of 10
34438●	Guedel airway 110 mm - orange - adult/large - 5	box of 10
34383	Guedel airway 120 mm - purple - adult/x-large	box of 10
34439	Mixed Guedel airways pack of 1 pcs. of ● marked and 2 pcs. of ▲ marked airways for a total of 10 pcs.	



code	GUEDEL AIRWAYS - NON STERILE FLEXIBLE, TRANSPARENT,	Minimum order
57751	Guedel airway 40 mm - pink - newborn - 000	box of 50
57752	Guedel airway 50 mm - blue - newborn - 00	box of 50
57753	Guedel airway 60 mm - black - child - 0	box of 50
57754	Guedel airway 70 mm - white - boy - 1	box of 50
57755	Guedel airway 80 mm - green - adult/small - 2	box of 50
57756	Guedel airway 90 mm - yellow - adult/small - 3	box of 50
57757	Guedel airway 100 mm - red - adult/medium - 4	box of 50
57758	Guedel airway 110 mm - orange - adult/large - 5	box of 50

SILICONE AUTOCLAVABLE AND SINGLE USE FACEMASKS

GIMA AUTOCLAVABLE FACE MASKS

Made in silicone and polycarbonate (sizes 3, 4, and 5) or all in silicone (sizes 0, 1 and 2). Completely transparent, allowing a total visibility. They can be used with any resuscitator and lung ventilator.

AUTOCLAVABLE UP TO 40 TIMES



code	SILICONE FACE MASKS LATEX FREE
34220	Facemask N° 0 - infant small
34221	Facemask N° 1 - infant large
34222	Facemask N° 2 - child small
34223	Facemask N° 3 - child large
34224	Facemask N° 4 - adults small
34225	Facemask N° 5 - adults large

GIMA PLUS AUTOCLAVABLE FACE MASKS - ANAESTHESIA MASKS

Blue silicone inflating cuff and unbreakable transparent polysulfone hood. They can be used with any resuscitator or lung ventilator. Available in 5 sizes. Latex free.

AUTOCLAVABLE UP TO 120 TIMES



code	GIMA PLUS FACE MASKS LATEX FREE
34252	Face mask N°2 - child small
34253	Face mask N°3 - child large
34254	Face mask N°4 - adult small
34255	Face mask N°5 - adult large
34250	Face mask N°6 - adult extra large

HIGH QUALITY

INFLATABLE AIR CUSHION

FACE MASKS - ANAESTHESIA MASKS
Quality disposable single patient face masks provided of connector for air inflation and hook. Available in 7 sizes.

CE 0434

SINGLE PATIENT

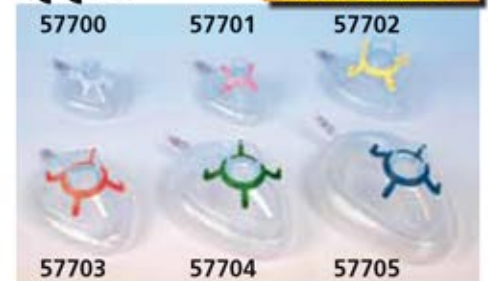

code	GIMA SINGLE PATIENT FACE MASKS LATEX FREE
57700	Facemask N° 0 - newborn - white
57701	Facemask N° 1 - infant - pink
57702	Facemask N° 2 - child - yellow
57703	Facemask N° 3 - child large - red
57704	Facemask N° 4 - adult - green
57705	Facemask N° 5 - adult large - blue
57706	Facemask N° 6 - adult extra large

OXYGEN RESERVOIRS, VALVES AND ACCESSORIES

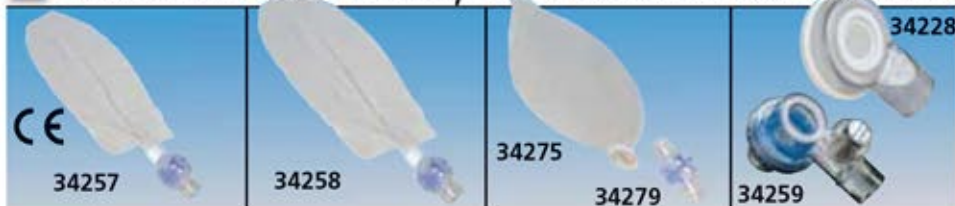

code	OXYGEN RESERVOIR - OXYGEN TUBE	To be used with GIMA codes
34275	SINGLE USE OXYGEN RESERVOIR - 2,500 ml - without valve	34244 - 34245 - 34277 - 34200 (need valve 34279), AMBU, LAERDAL 34275
34279	RESERVOIR VALVE - autoclavable	34246 - 34247 - 34248 - 34249
34257	SINGLE USE OXYGEN RESERVOIR - 1,000 ml - with valve	34244 - 34245 - 34277
34258	SINGLE USE OXYGEN RESERVOIR - 2,500 ml - with valve	All resuscitators
34276	OXYGEN TUBE - 2 m	34244 - 34245 - 34277
34259	NON-REBREATHING VALVE with 60 cm H ₂ O Pop-off - autoclav.	34244-5 - 34277 (need 34228)
34227	PEEP VALVE - 30 mm (5-20 cm H ₂ O) autoclavable at 121°C/248°F	34230 - 34240 - 34200
34228	PEEP VALVE ADAPTOR - int. Ø 22 mm, ext. Ø 30 mm	34227 - 34248 - 34249
34256	REAR VALVE (intake valve)	34244 - 34245 - 34246 - 34247

ULTRA FACE MASKS

ULTRA ANAESTHESIA - FACE MASKS

Disposable single patient face masks. Anti-slip design and anatomical shape for a precise fit. Excellent visibility, soft and comfortable seal. Provided with hook. Medical grade non-PVC, phthalate free.



code	ULTRA SINGLE PATIENT FACE MASKS LATEX FREE - box of 50	Suitable for kg
57711	Facemask N° 1 - infant - pink	2-10
57712	Facemask N° 2 - child - yellow	10-25
57713	Facemask N° 3 - adult S - green	25-60
57714	Facemask N° 4 - adult M - red	60-110
57715	Facemask N° 5 - adult L - blue	>110

MOUTH OPENERS AND TONGUE HOLDING



- 34272 HELICOIDAL MOUTH OPENER PINOCCHIO
- 34273 TEETH SCREW DRIVER
- 34274 TONGUE HOLDING FORCEPS

NYLON BAG

- 34271 NYLON BAG Suitable for all resuscitators



STERILE CUFFED AND UNCUFFED ENDOTRACHEAL TUBES

code	UNCUFFED ENDOTRACHEAL TUBES - STERILE	Minimum order	code	CUFFED ENDOTRACHEAL TUBES - STERILE	Minimum order
34385	Uncuffed Endotracheal tube Ø 3 mm - 16.5 cm	box of 10	34387	Cuffed Endotracheal tube Ø 3.5 mm - 18.5 cm	box of 10
34386	Uncuffed Endotracheal tube Ø 4 mm - 21 cm	box of 10	34388	Cuffed Endotracheal tube Ø 5 mm - 24.5 cm	box of 10
			34389	Cuffed Endotracheal tube Ø 6 mm - 28.5 cm	box of 10
			34390	Cuffed Endotracheal tube Ø 6.5 mm - 29.5 cm	box of 10
			34391	Cuffed Endotracheal tube Ø 7 mm - 31 cm	box of 10
			34392	Cuffed Endotracheal tube Ø 7.5 mm - 31.5 cm	box of 10
			34393	Cuffed Endotracheal tube Ø 8 mm - 33 cm	box of 10
			34394	Cuffed Endotracheal tube Ø 8.5 mm - 33 cm	box of 10
			34395	Cuffed Endotracheal tube Ø 9 mm - 33 cm	box of 10
			34396	Cuffed Endotracheal tube Ø 10 mm - 33 cm	box of 10

Ø: Internal diameter

LARYNGEAL MASKS FOR SAFE AND EASY INTUBATION

SILICONE REUSABLE LARYNGEAL AIRWAY MASK

- Optimal anatomical design ensure convenient and safe insertion. Universal 15 mm connector (ISO).
- See-through flexible airway tube, clear guideline for easy insertion.
- Tiny protruding bumps minimize the vomiting substance flowing from exophagus and into the lung.
- Seamless cuff formation offers maximum comfort.
- Strengthened oval tip prevents possible bending during insertion.
- Thin walled pilot balloon facilitates the sensing of the inflation tube.

code	Size	Patient range	Weight range	Cuff volume (ml. of air)
34424	1.5	infant	5-10 kg	7 ml
34425	2	infant	10-20 kg	10 ml
34426	2.5	child	20-30 kg	14 ml
34427	3	boy	30-50 kg	20 ml
34428	4	adult	50-70 kg	30 ml
34429	5	adult	>70 kg	40 ml

CE 0476

Each laryngeal airway mask is individually serialized for identification and traceability purposes



AMBU® AURAONCE™ DISPOSABLE LARYNGEAL MASK

AMBU® AURAONCE™ DISPOSABLE LARYNGEAL MASKS

AuraOnce has a special curve that carefully replicates natural human anatomy. Molded directly into the tube, the unique shape makes correct insertion easy without abrading the upper airway. AuraOnce's curve also ensures that the patient's head remains in a natural supine position when the mask is in use without extra stress on the upper jaw. Moreover, Auraonce is specially designed to give the airway tube the flexibility needed to adapt to individual anatomical variances and wide range of head positions. AuraOnce has a D-shaped airway tube to give a firm and ergonomic grip during insertion. In short, positioning is fast and accurate, with least possible internal pressure.

- Packaged sterile and ready for use
- Colour coded pouch with directions for use
- Available in 5 sizes fitting a wide range of patients.



Cuff and airway tube moulded as single unit with built-in, anatomically correct curve

The airway tube is flexible at the cuff and rigid at the connector for easy, atraumatic insertion and removal



code	AMBU® AURAONCE™	Patient weight	Maximum cuff inflation volume
34406	Laryngeal Mask N 2 - pink	10-20 kg	10 ml
34407	Laryngeal Mask N 2.5 - pink	20-30 kg	14 ml
34408	Laryngeal Mask N 3 - green	30-50 kg	20 ml
34409	Laryngeal Mask N 4 - yellow	50-70kg	30 ml
34410	Laryngeal Mask N 5 - blue	70-100 kg	40 ml

AMBU® AURA-i™ LARYNGEAL MASK VENTILATION & INTUBATION

AMBU® AURA-i™ DISPOSABLE LARYNGEAL MASKS

Ambu® Aura-i™ is a disposable laryngeal mask designed for everyday use. Pre-formed to follow the anatomy of the human airway, the soft rounded curve of the Aura-i ensures fast and easy placement and guarantees long-term performance. Aura-i is the preferred everyday routine device for establishing an airway where an ET-tube is deemed unnecessary. At the same time it holds a place on the difficult airway cart. In case of a "Cannot Intubate - Cannot mask Ventilate" (CI-CV) situation, where the purpose is to intubate the patient, Aura-i can be used as conduit for direct endotracheal intubation assisted by a flexible scope.

The airway tube is designed to allow easy passage of an appropriately sized ET-tube. The recommended ET-tube size is indicated on the connector block of the mask. Aura-i comes in a complete range of 5 sizes, suitable for pediatrics and adults.

- packaged sterile and ready for use
- colour coded pouch with directions for use
- available in 5 sizes fitting a wide range of patients.

Direct endotracheal intubation using a flexible scope and standard ET-tubes



Built-in, anatomically correct curve for fast and easy insertion

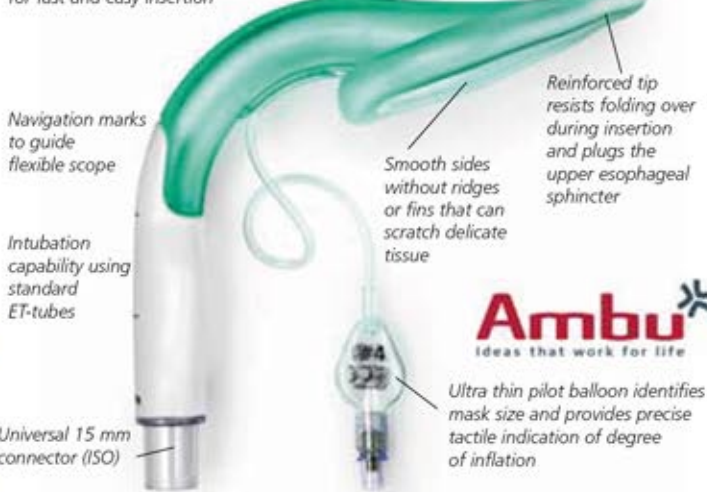

code	AMBU® AURA-i™	Patient weight	Maximum cuff inflation volume	Mask ET-Tubes
34593	Laryngeal Mask N 2 - pink	10-20 kg	10 ml	5.0
34594	Laryngeal Mask N 2.5 - violet	20-30 kg	14 ml	5.5
34595	Laryngeal Mask N 3 - green	30-50 kg	20 ml	6.5
34596	Laryngeal Mask N 4 - orange	50-70kg	30 ml	7.5
34597	Laryngeal Mask N 5 - blue	70-100 kg	40 ml	8.0

TECHNICAL SPECIFICATIONS	
Maximum intra-cuff pressure:	60 cm H ₂ O
Airway connector:	15 mm ISO 5356-1
Tube/cuff material:	PVC

STANDARD LARYNGOSCOPE BLADES AND SETS - 2.5 V

McINTOSH BLADES

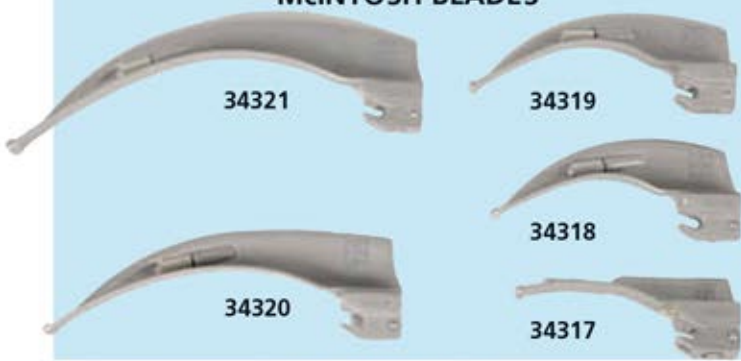

MILLER BLADES



- Great features of the unique GIMA blades and handles
- standard 2.5 V vacuum bulb
 - light ergonomic, satin finish handle to reduce glare
 - Stainless Steel contacts guarantee long working life
 - easy sterilization ETO or steam
 - full range of Mc Intosh & Miller blades, latex free
 - ISO 7376 fittings allow use of blades with existing handles
 - set is packaged in an anti-shock case and in cardboard box
 - 2.5 V handles work with both alkaline batteries or rechargeable batteries
 - good light transmission of 3,500 LUX with 2.5 V handles
 - autoclavable up to 134° for 5 minutes (approx. 2,000 times)
 - non magnetic blades and handles

code	STANDARD RECHARGEABLE SETS (HANDLE+BLADES)	
34301	Pediatric set	2 blades MILLER 0-1
34307	Pediatric set	3 blades MILLER 00-0-1
34305	Pediatric set	3 blades MILLER 0-1, Mc INTOSH 0
34306	Doctor set	3 blades MILLER 1, 2, 3
34302	Adult set	3 blades Mc INTOSH 2-3-4
34303	Adult set	4 blades Mc INTOSH 1-2-3-4

code	BULBS, BATTERIES AND RECHARGEABLE HANDLES	
34352	Small rechargeable handle - pediatric (2xAAA) - 2.5 V	
34354	Large rechargeable handle - adult (2XC) - 2.5 V	
34466	Pediatric rechargeable Li-ion battery 2.5 V AA	
34467	Adult rechargeable Li-ion battery 2.5 V "C"	
<i>Charging time 2.5 hours (34466), 5 hours (34467)</i>		
31542	Charging station (including pediatric adaptor, wall support, UK, US and EU plug) 100-240 V	
34324	Small Bulbs for MAC N°0 and MILLER N°00,0,1	
34325	Large Bulbs for MAC N°1,2,3,4 and MILLER N°2,3	
<i>compatible with Kawe and Riester</i>		



code	STANDARD BLADES	Overall Length mm	Distal Width mm
34310	Blade N° 00 MILLER OXY - premature	65	12.5
34311	Blade N° 0 MILLER - premature/newborn	78	11.5
34312	Blade N° 1 MILLER - babies	102	11.5
34313	Blade N° 2 MILLER - adults	155	16.5
34314	Blade N° 3 MILLER - adults/large	195	16.5
34317	Blade N° 0 Mc INTOSH - newborn	80	13
34318	Blade N° 1 Mc INTOSH - babies	92	14
34319	Blade N° 2 Mc INTOSH - infants	100	14
34320	Blade N° 3 Mc INTOSH - adults	130	18
34321	Blade N° 4 Mc INTOSH - adults/large	155	18

DISPOSABLE F.O. LARYNGOSCOPE BLADES MILLER AND MC INTOSH

SINGLE-PATIENT USE LARYNGOSCOPE F.O. BLADES
Choice of 5 different blades: Mc Intosh N° 2, 3, 4 and Miller N° 0,1. All blades are tested for tensile strength. Individually packed, non sterile.

COMPATIBILITY WITH ALL "GREEN" F.O. SYSTEMS

- 34381 EMERGENCY PACK: plastic handle +3 disposable blades Mc Intosh N° 2,3,4
- 34382 NYLON BAG - empty
- 34384 EMERGENCY CASE: plastic handle+6 disposable blades Miller 0,1,2 and Mc Intosh 2,3,4.

code	DISPOSABLE BLADES NON STERILE	Overall Length mm	Distal Width mm
34481	Metal handle		
34364	Plastic handle		
34365	N° 0 Miller - infant	90	22
34366	N° 1 Miller - child	100	23.3
34375	N° 2 Mc Intosh - adult small	115	34.4
34376	N° 3 Mc Intosh - adult	132	40.6
34377	N° 4 Mc Intosh - adult large	155	58.7
34359	Bulb for old plastic handle sold up to may 2016		
34358	Bulb for new plastic handle sold since june 2016		



GIMA GREEN F.O. XENON/HALOGEN AND LED LARYNGOSCOPES



GIMA GREEN LARYNGOSCOPES

- maximum light transmission thanks to durable and high quality fibres
- specially designed blades for easy intubation
- matt finished to reduce glare
- autoclavable up to 134°C for 5 minutes. Blades autoclavable up to 2,000 times
- compatible to plasma sterilization
- all blades are compatible to BS EN ISO 7376 Green standard handles
- all blades are made from Austenitic Stainless steel thereby making them rust proof
- long life blades. GIMA offers 3 years Warranty
- a large selection of power sources to use: 'AA' and 'C' type batteries or 2.5 V and 3.5 V rechargeable batteries
- 2.5 V handles can be used with standard or rechargeable batteries
- handles are available with 2.5 V and 3.5 V Xenon/Halogen and LED bulbs
- all blades and handles are non magnetic

Mc INTOSH BLADES

MILLER BLADES

HALOGEN/XENON BATTERY HANDLE

LED BATTERY HANDLE



Gima Green and Maxlite: Miller and Mc-Intosh blades

- Gima Green 4.0 mm Ø F.O. bundle with more than 5,500 individual fibre strands
- Miller Maxlite 3.0 mm Ø bundle with more than 5,000 individual fibre strands
- McIntosh Maxlite 4.5 mm Ø bundle with more than 6,500 individual fibre strands

High quality fibres ensuring excellent light transmission Gima Green and Miller

- Maxlite:** 7,000 lux with 2.5 V Xenon/Halogen lamp, 12,500 lux with 3.5 V Xenon/Halogen lamp, 18,000 lux with 2.5 LED lamp, 30,000 lux with 3.5 V LED lamp
- McIntosh Maxlite:** 8,000/14,000/20,000/40,000 lux



Xenon/Halogen and LED handles 2.5 V and 3.5 V

- closed battery compartment prevents liquid penetrating inside the battery
- handles are supplied with lamp. Battery not included
- solid metal handle of chromium plated metal

GIMA GREEN RECHARGEABLE BATTERY HANDLES

G.F.O. XENON/HALOGEN BATTERY HANDLES - 2.5 V	
code	34480 Pediatric rechargeable metal handle (2xAA) - 2.5 V
code	34481 Adult rechargeable metal handle (2xC) - 2.5 V
code	34466 Pediatric rechargeable Li-Ion battery 2.5 V 1,000 mAh
code	34467 Adult rechargeable Li-Ion battery 2.5 V 2,200 mAh
code	34485 Halogen bulb 2.5 V (minimum order 6 pcs)
"GIMA GREEN" RECHARGEABLE HANDLES AND BATTERIES 3.5 V - OLD up to lot 8 (ped handle) up to lot 7 (adult handle)	
code	34487 Pediatric rechargeable metal handle (3.5 V) - old
code	34488 Adult rechargeable metal handle (3.5 V) - old
code	34489 Pediatric rechargeable NiCa battery 3.5 V/700 mAh for 34487
code	34490 Adult rechargeable NiCa battery 3.5 V/1,300 mAh for 34488
code	34491 Halogen Bulb 3.5 V
F.O. XENON/HALOGEN BATTERY HANDLE 3.5 V	
code	34456 Pediatric rechargeable metal handle (3.5 V)
code	34457 Adult rechargeable metal handle (3.5 V)
code	31540 Pediatric rechargeable Li-ion battery** 3.5 V for 34456
code	31541 Adult rechargeable Li-ion battery** 3.5 V for 34457, 34482
**for handles sold after may 2013	
code	34491 Halogen Bulb 3.5 V
F.O. LED BATTERY HANDLES 2.5 V AND 3.5 V	
code	34476 Pediatric LED rechargeable handle 2.5 V
code	34477 Adult LED rechargeable handle 2.5 V
code	34482 Adult rechargeable metal handle - LED light 3.5 V

code	"GIMA MAXLITE" FIBRE OPTIC BLADES	A	B
58051	MILLER N° 0 blade - Newborn	80	55
58052	MILLER N° 1 blade - Infant	100	75
58056	Mc INTOSH N° 0 blade - Newborn	82	57
58057	Mc INTOSH N° 1 blade - Infant	93	68
58058	Mc INTOSH N° 2 blade - Child	115	90
58059	Mc INTOSH N° 3 blade - Adult	135	110
58060	Mc INTOSH N° 4 blade - Adult large	155	130
58061	Mc INTOSH N° 5 blade - Adult x-large	176	151

code	"GIMA GREEN" FIBRE OPTIC BLADES*	A	B
34460	MILLER N° 00 OXY blade - Premature	65	40
34461	MILLER N° 0 blade - Newborn	78	53
34462	MILLER N° 1 blade - Infant	102	77
34463	MILLER N° 2 blade - Child	155	130
34464	MILLER N° 3 blade - Adult	195	170
34469	Mc INTOSH N° 0 blade - Newborn	80	55
34470	Mc INTOSH N° 1 blade - Infant	92	67
34471	Mc INTOSH N° 2 blade - Child	100	75
34472	Mc INTOSH N° 3 blade - Adult	130	105
34473	Mc INTOSH N° 4 blade - Adult large	155	130
34474	Mc INTOSH N° 5 blade - Adult x-large	175	150

*equipped with detachable fibre optic light guide

F.O. LIGHT GUIDE FOR GIMA GREEN BLADES

code	34483 F.O. Light guide for "GIMA Green" N°3
code	34484 F.O. Light guide for "GIMA Green" N°4
code	34486 F.O. Light guide for "GIMA Green" other - specify code

• 31542 GIMA GREEN CHARGING STATION - 100/200 V - 50/60 Hz
It can charge either 2.5 V / 3.5 V NiCa, NimH or Li-ion rechargeable batteries independently of their status of charge. Unit is designed to prevent over charging of batteries. Simultaneously charging of pediatric and adult handle.



Charging station includes pediatric adaptor, wall support, UK, US and EU plug

COMPATIBILITY HANDLE - BATTERY - BULB

code	Handle		V	Battery			Bulb
	Xenon	LED		Standard 2xAA	Rechargeable 2xC	Li-ion*	
34480	Ped.	-	2.5	yes	no	34466	34485
34481	Adult	-	2.5	no	yes	34467	34485
34456	Ped.	-	3.5	no	no	31540	34491
34457	Adult	-	3.5	no	no	31541	34491
34476	-	Ped.	2.5	yes	no	34466	-
34477	-	Adult	2.5	no	yes	34467	-
34482	-	Adult	3.5	no	no	31541	-

*Li-ion batteries have twice the capacity of an equivalent size NimH batteries.

GIMA GREEN F.O. XENON/HALOGEN, LED LARYNGOSCOPE SETS



GIMA F.O. XENON/HALOGEN AND LED SETS

- Mc Intosh or Miller blades
- F.O. laryngoscopes provide cool bright illumination
- Gima Green F.O. blades with detachable fibre or Maxlite F.O. blades with integrated fibre
- Xenon/Halogen or LED F.O. rechargeable battery handle
- 2.5 V or 3.5 V rechargeable battery handle (battery not included). 2.5 V rechargeable battery handle can be used with standard or rechargeable batteries. Rechargeable battery handles should be used with charging station 31542 (not included).
- non magnetic blades and handles

LARYNGOSCOPE SET WITH F.O. BLADES

GIMA GREEN F.O. XENON/HALOGEN SET - 2.5 V		
code		
34451	Pediatric set	2 blades Miller 0-1
34454	Pediatric set	3 blades Miller 0-1, Mc Intosh 0
34452	Adult set	3 blades Mc Intosh 2-3-4
34453	Adult set	4 blades Mc Intosh 1-2-3-4
34455	Doctor set	3 blades Miller 1-2-3
34485	Halogen bulb 2.5 V (minimum order 6 pcs)	
34450	Empty box without sponge	
GIMA GREEN F.O. LED SET - 2.5 V OR 3.5 V		
code		
34327	Adult set	3 blades Mc Intosh 2-3-4 - 2.5 V
34328	Adult set	4 blades Mc Intosh 1-2-3-4 - 2.5 V
34329	Adult set	3 blades Mc Intosh 2-3-4 - 3.5 V
34330	Adult set	4 blades Mc Intosh 1-2-3-4 - 3.5 V

MAXLITE F.O. BLADE WITH INTEGRATED FIBRE

Built with an integrated F.O. bundle with no cavities to trap dirt or body fluids, this allowing the blade to be easily cleaned and decontaminated.



GIMA GREEN F.O. BLADE

TECHNICAL SPECIFICATIONS - BLADES AND BULBS

	Gima Green F.O. blade	Maxlite F.O. Mc Intosh blade
Fibre light carrier:	detachable	integrated
F.O. bundle Ø:	4.0 mm	4.5 mm
Individual fibre strands:	> 5,500	> 6,500
Light transmission with 2.5 V (Xenon):	7,000 lux	8,000 lux
Light transmission with 2.5 V (LED):	18,000 lux	20,000 lux
Light transmission with 3.5 V (Xenon):	12,500 lux	14,000 lux
Light transmission with 3.5 V (LED):	30,000 lux	40,000 lux
Autoclavable at 134 °C:	2,000 times	2,000 times
LED bulb life:	50,000 hours	50,000 hours

LARYNGO SET WITH F.O. BLADES - INTEGRATED FIBRE

MAXLITE F.O. XENON/HALOGEN SET - 2.5 V		
code		
34332	Pediatric set	3 blades Miller 00-0-1
34333	Adult set	3 blades Mc Intosh 1-2-3
34334	Adult set	4 blades Mc Intosh 1-2-3-4
34485	Halogen bulb 2.5 V (minimum order 6 pcs)	
MAXLITE F.O. LED SET - 2.5 V or 3.5 V		
code		
34336	Pediatric set	3 blades Miller 00-0-1 - 2.5 V
34335	Adult set	3 blades Mc Intosh 2-3-4 - 2.5 V
34337	Adult set	4 blades Mc Intosh 1-2-3-4 - 2.5 V
34338	Adult set	4 blades Mc Intosh 1-2-3-4 - 3.5 V
BATTERIES FOR GIMA GREEN and MAXLITE		
code		
34466	Pediatric rechargeable Li-ion battery 2.5 V 1,000 mAh	
34467	Adult rechargeable Li-ion battery 2.5 V 2,200 mAh	
31541	Adult rechargeable Li-ion battery 3.5 V*	

*Packed and shipped at half charged state

FLEXTIP F.O. XENON/HALOGEN AND LED SETS FOR DIFFICULT INTUBATIONS

F.O. SET FOR DIFFICULT INTUBATION

Deluxe boxed set including one F.O. rechargeable handle, one or two F.O. Mc Intosh blades N° 3 or N° 3 and 4, for difficult intubations and bulb. The movable blade tip facilitates lifting of the epiglottis and enables a perfect visibility of the intubation process even in case of difficult anatomical conditions. A better visibility and a lower lever force reduce the risk of injury of the larynx and the teeth. Autoclavable at 134° C.

- stainless steel construction, matt finish
- can be used with all Green Spec Handles
- compatible with ISO 7376 Green Standards
- channel provides improved viewing area
- 4.0 mm fibre bundles (GimaGreen) or 4.5 mm fibre bundle (Maxlite) for maximum light output
- 2x"C" batteries or rechargeable batteries



34492



34494

34493

FLEXTIP F.O. SET - 2.5 V		
code		
34492	GIMA GREEN FLEXI F.O. SET 1 blade Mc Intosh 3	
34495	GIMA GREEN FLEXI F.O. SET 2 blades Mc Intosh 3-4	
34498	MAXLITE F.O. LED FLEXI SET 2 blades Mc Intosh 3-4 with integrated fibre	

ACCESSORIES AND SPARES		
code		
34493	FLEXI F.O. BLADE N° 3 Mc Intosh (130x105 mm)	
34494	FLEXI F.O. BLADE N° 4 Mc Intosh (155x130 mm)	
34485	Bulb 2.5 V - spare	
34467	Adult rechargeable Li-ion battery 2.5 V	
31542	Charging station 100-240 V - see page 327	

HEINE CLASSIC+® F.O. XHL OR LED^{HQ} LARYNGOSCOPES

HEINE CLASSIC+® F.O. XHL OR LED^{HQ} LARYNGOSCOPES

The "Classic+" range of F.O. blades with HEINE HiLite® Fibre bundle with over 6,500 individual micro-fibres offer improved light transmission and longer life. Together with the innovative HEINE LED^{HQ} light in the handle or the traditional XHL Xenon Halogen Bulb, the exclusive HEINE HiLite® Fibre Optic bundle with up to 4.3 mm of Ø offers 3X or 40% brighter light as with other conventional halogen bulbs.

5 years warranty 5-years guarantee or 4,000 standard autoclave cycles of 134°C/5 min. with more than 1,000 lux on all blades with HEINE HiLite® fibre bundle.

Long lasting bulbs HEINE XHL® Xenon Halogen bulbs incorporate the latest Xenon Halogen Technology to give you up to 40% more light! HEINE XHL Xenon Halogen 3.5 V bulbs last up to twice as long as 2.5 V bulbs and give up to three times the light of conventional 2.5 V Halogen laryngoscope bulbs. HEINE LED^{HQ} handles offer even three times the light intensity of the 3.5V Xenon Halogen bulbs for an outstanding and constant bright illumination.

Long lasting 3.5 V rechargeable batteries HEINE 3.5 V systems (LED^{HQ} or XHL) use a long-lasting 3.5 V lithium rechargeable battery which avoids the need to replace non-rechargeable batteries at frequent intervals. HEINE F.O. laryngoscope blades and handles are compatible with the ISO 7376 (green standard).

For fast charge in 2 hours

Size: 14x6x6.6 cm



34374

• **34374 NT 4 CHARGER UNIT FOR 2 HANDLES - X-002.99.494**

- Two independent charging compartments:
- fast charge capability: 2 hours for Li-ion handle
- automatic charging
- charger indicator



5 YEARS WARRANTY



code	HEINE code	HEINE FIBRE OPTIC BLADES	Overall length	Distal length
34411	F-000.22.119	MILLER 00	76 mm	9.5 mm
34412	F-000.22.120	MILLER 0	80 mm	10.5 mm
34413	F-000.22.121	MILLER 1	100 mm	11.5 mm
34414	F-000.22.122	MILLER 2	152 mm	13 mm
34415	F-000.22.110	PAED 0	82 mm	12 mm
34416	F-000.22.111	PAED 1	95 mm	13 mm
34417	F-000.22.100	MAC 0	82 mm	9 mm
34418	F-000.22.101	MAC 1	93 mm	11 mm
34419	F-000.22.102	MAC 2	115 mm	13 mm
34420	F-000.22.103	MAC 3	135 mm	15 mm
34421	F-000.22.104	MAC 4	155 mm	15 mm
34422	F-000.22.105	MAC 5	176 mm	15 mm
34423	F-000.22.313	MAC 3 - Flex Tip+	115 mm	13.2 mm
34368	F-000.22.314	MAC 4 - Flex Tip+	137 mm	13.2 mm

HEINE STANDARD LARYNGOSCOPE HANDLES AND ACCESSORIES

34430	F-001.22.800	Slim F.O. handle 2.5 V - pediatric
34400	F-001.22.812	Short F.O. handle 2.5 V - pediatric and obese
34401	F-001.22.860	Standard F.O. handle 2.5 V
34405	F-008.22.860	Standard F.O. handle 2.5 V LED
31769	X-001.88.035	Spare bulb 2.5 V for 34400, 34401, 34430
31768	X-002.88.044	Spare bulb 3.5 V for 34369

HEINE RECHARGEABLE LARYNGOSCOPE HANDLES AND BATTERIES

34371	F-008.22.804	Pediatric LED handle 2.5 V Li-ion rechargeable*
34372	F-007.22.894	Standard F.O. handle 3.5 V Li-ion - rechargeable*
34373	F-008.22.894	Standard LED handle 3.5 V Li-ion - rechargeable*
34378	X-007.99.104	Re-chargeable 2.5 V battery pediatric for 34371
34448	X-007.99.383	Re-chargeable 3.5 V battery for 34372-3, 34402, 34367

HEINE CLASSIC+® FIBRE OPTIC LARYNGOSCOPE SETS with 2.5V handle**

34403	F-119.10.860	3 blades set with paed 1, mac 2, mac 3, XHL handle
34404	F-120.10.860	4 blades set with paed 1, mac 2, mac 3, mac 4, XHL handle
34446	F-120.18.860	4 blades set with paed 1, mac 2, mac 3, mac 4, LED HQ handle

with 3.5V rechargeable handle

34367	F-119.94.865	3 blades set with paed 1, mac 2, mac 3, LED HQ rechargeable handle
-------	--------------	--

**Set includes spare bulb and F.O. handle 2.5 V (34401) or F.O. LED handle 2.5 V

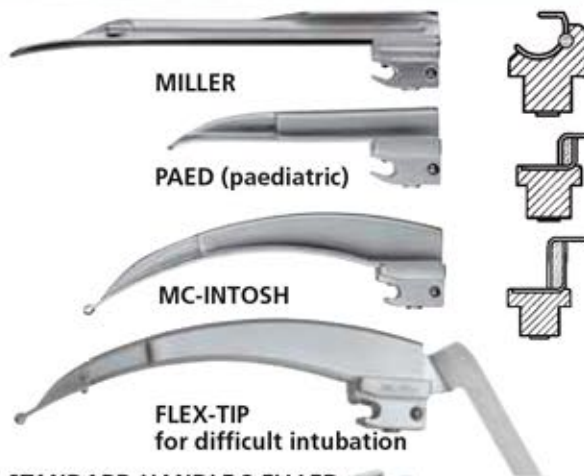

STANDARD HANDLE 3.5V LED Li-ion®

Rechargeable 3.5V F.O. LED handle with charge status display in bottom cap. State of charge is indicated for 10 seconds after switching on or after removing from the charger. Two hours charging time with NT4 charger, up to 13 hours ON time.

LED HANDLE:
- 5,000 Kelvin
- 12,000 LUX at 40 mm
- 50,000 hours bulb life

Handle with charge status display

LED HQ
LED NOW IN HEINE QUALITY.



AMBU® KING VISION® VIDEO LARYNGOSCOPE

• 58101 KING VISION® VIDEO LARYNGOSCOPE SET

The King Vision® video laryngoscope is especially designed to visualize, in the most reliable way, the airways for routine and difficult intubations.

The reusable display is lightweight, water resistant, non-glare, smudge-proof, packaged in a protective foam case and is battery operated.

The blades are disposable and are individually packaged, eliminating cross contamination risks.

It can be used continuously about 80 minutes, making it highly portable.

Video output compatible with external monitor and recording devices.

Two blade types: a standard blade that requires the use of a stylet to direct the ET tube and a channeled blade where you can guide the ET tube with the blade.

Made in the U.S.A.

- 58104 STANDARD VISION BLADE - size 3 - spare
- 58105 CHANNELED VISION BLADE - size 3 - spare

STANDARD ACCESSORIES

- Vision display
- 3 channeled vision blades - size 3
- 1 standard vision blade - size 3
- AAA batteries
- Case



USB F.O. LARYNGOSCOPE HANDLE

• 34468 USB F.O. LARYNGOSCOPE HANDLE

Universal USB handle for green fibre optic blades. This handle is a charging unit including lithium-ion rechargeable battery and USB port for easy recharging without charging station.

Features:

- glass bead blasted, matt chromium plated surface for a high quality optic
- no surface structure, lateral grooves for hygienic use and secure grip in the hand
- metallic lamp case
- quick and easy removal of bulb
- autoclavable up to 134° (without batteries)
- handle in accordance with ISO 7376 (green standard)

Made in Germany.



F.O. LARYNGOSCOPE BLADES AND BATTERY HANDLES SINGLE PATIENT STERILE

SINGLE PATIENT USE F.O. LARYNGOSCOPE BLADES

Choice of 6 blades Miller 0.1 and McIntosh 1, 2, 3, 4 for everyday hospital use. Compatible to ISO 7376 Green System. Light conductor made from material with excellent light transmission: 4,000 lux with 2.5 V Xenon handle and 10,000 lux with LED handle. Need F.O. handle.

A high impact resistant plastic block coupled with metal spatula provides great strength to the whole blade comparable to all metal reusable blades



code	SINGLE PATIENT F.O. BLADES	A	B
58001	MILLER N° 0 blade - Newborn	78	54
58002	MILLER N° 1 blade - Infant	105	80
58006	Mc INTOSH N° 1 blade - Infant	90	66
58007	Mc INTOSH N° 2 blade - Child	100	76
58008	Mc INTOSH N° 3 blade - Adult	130	106
58009	Mc INTOSH N° 4 blade - Adult large	155	131

SINGLE PATIENT USE BATTERY HANDLES

- lightweight, suitable for everyday hospital use
- single patient use, prevent cross infection
- compatible to ISO 7376 Green System
- perfect solution to cleaning problems confronting EMS field
- Ready To Use (RTU) handles are supplied with preloaded batteries, thus eliminating the hessel of loading batteries
- the 'C' type handles are identified with yellow colour bottom cap, supplied without batteries
- suitable also for reusable blades
- made in ABS



code	SINGLE PATIENT USE F.O. LED BATTERY HANDLES 2.5 V
58012	Battery handle "C" type - adult
58014	Battery handle "RTU" (ready to use) - pediatric
58015	Battery handle "RTU" (ready to use) - adult

EMERGENCY KITS COMPLETE WITH STANDARD EMERGENCY DEVICES



34173

SMART BAGS - medium - blue

- 27152 SMART BAG - medium empty - 55x35xh 32 cm
- 34173 "GIMA 3" EMERGENCY BAG - filled - without cylinder



34174

SMART BAGS - large - red

- 27153 SMART BAG - large empty - 65x35xh 35 cm
- 34174 "GIMA 7" EMERGENCY BAG - filled



34163

LOGIC 2 RUCKSACKS - red

- 27171 LOGIC 2 RUCKSACK - empty - 40x25xh 47 cm
- 34162 "GIMA 8" EMERGENCY RUCKSACK - filled
- 34163 "GIMA 9" EMERGENCY RUCKSACK - filled
- 34164 "GIMA 10" EMERGENCY RUCKSACK - filled - without cylinder
- 34175 "GIMA 11" EMERGENCY RUCKSACK - filled

LOGIC 2 RUCKSACKS PVC COATED - red

- 27172 LOGIC 2 RUCKSACK PVC COATED - empty - 40x25xh 47 cm
- 34165 "GIMA 12" EMERGENCY RUCKSACK PVC COATED - filled - same as "GIMA 9", without cylinder

27172



EMERGENCY ALUMINIUM CASE

- 34159 ALUMINIUM CASE - empty - 40x35x10 cm
- 34161 "GIMA 2" EMERGENCY CASE - filled

34161

Aluminium emergency case



34156

EMERGENCY BAGS - red

- 27165 EMERGENCY BAG - empty - 35x45x21 cm
- 34155 "GIMA 6" EMERGENCY BAG - filled - without cylinder
- 34156 "GIMA 4" EMERGENCY BAG - filled
- 34157 "GIMA 5" EMERGENCY BAG - filled

EMERGENCY BAGS PVC COATED - blue

- 27167 EMERGENCY BAG PVC COATED - empty - 35x45xh 21 cm
- 34154 "GIMA 13" EMERGENCY BAG PVC COATED - filled - same as "GIMA 4", without cylinder

27167



34176

IP67 CERTIFIED DURABLE CASE - waterproof and dustproof

- 27222 LARGE DURABLE CASE - empty - 55x43xh 21 cm
- 34176 "GIMA 1" EMERGENCY DURABLE CASE - filled

EMERGENCY KITS - BAGS, RUCKSACKS, CASES

KIT CONTENTS	Size cm	34155	34156	34157	34154	34173	34174	34161	34176	34162	34163	34164	34175	34165
		GIMA 6 bag	GIMA 4 bag	GIMA 5 bag	GIMA 13 bag	GIMA 3 bag	GIMA 7 bag	GIMA 2 al case	GIMA 1 pl case	GIMA 8 rucksack	GIMA 9 rucksack	GIMA 10 rucksack	GIMA 11 rucksack	GIMA 12 rucksack
Container (bag, rucksack or case)														
Smart bag - medium - blue 600D polyester (27152)	55x35xh 32						•							
Smart bag - large - red 600D polyester (27153)	65x35xh35							•						
Emergency bag - red 600D polyester (27165)	35x45xh 21	•	•	•										
Emergency bag - blue 600D polyester PVC coated (27167)	35x45xh 21				•									
Logic 2 rucksack - red 600D polyester (27171)	40x25xh 47									•	•	•	•	
Logic 2 rucksack - red 600D polyester PVC coated (27172)	40x25xh 47													•
Durable case - orange (27222)	55x43xh 21								•					
Aluminium case (34159)	40x35xh 10							•						
Products included in kits														
Emergency cover (34085)		•	•	•	•	•	•	•	•	•	•	•	•	•
Universal scissors - 15 cm (34128)		•	•	•	•	•	•	•	•	•	•	•	•	•
Facemask n. 2 - child/small (34222)		•	•	•	•	•	•	•	•	•	•	•	•	•
Silicone resuscitator bag with mask n 4 - adult (34245)		•	•	•	•	•	•	•	•	•	•	•	•	•
Teeth screw driver (34273)		•	•	•	•	•	•	•	•	•	•	•	•	•
Tongue holding forceps (34274)		•	•	•	•	•	•	•	•	•	•	•	•	•
Oxygen tube - 120 cm (34276)		•	•	•	•	•	•	•	•	•	•	•	•	•
Mixed Guedel airways - box of 10 (34439)		•	•	•	•	•	•	•	•	•	•	•	•	•
Oxygen therapy mask - adult (34166)		•	•	•	•	•	•	•	•	•	•	•	•	•
0.5 l oxygen cylinder (empty) with reducer UNI std (34500)		•	•	•	•	•	•	•	•	•	•	•	•	•
Yton nurse stethoscope (32514)		•	•	•	•									
Jotarap dual head stethoscope - black (32580)						•	•	•	•	•	•	•	•	•
Yton sphygmomanometer (32720)		•	•											
London sphygmomanometer (32725)				•		•	•	•	•	•	•	•	•	•
Welch Allyn DURASHOCK sphygmomanometer (32700)													•	
Emergency pack - 3 F.O. single-use blades+plastic handle (34381)		•	•		•					•				
Laryngoscope set 3 Mc-Intosh blades 2-3-4 (34302)				•		•	•				•	•	•	•
"Gima green" F.O. laryngoscope set 4 Mc-Intosh blades 1-2-3-4 (34453)													•	•
Hand suction unit (28180)		•				•	•						•	
Res-q-vac hand suction unit (28124)				•					•		•		•	•
Delta pen light (25629)						•	•		•				•	•
Fast tourniquet - green (25728)				•		•	•		•		•		•	•
Magill forceps - 20 cm (34002)						•	•		•		•		•	•
Gima digital thermometer °C (25560)				•		•	•		•				•	•
Disinfectant wipes - tube 100 wipes (36625)				•		•	•		•				•	•
Emocontrol elastic bandage (34782)				•		•	•		•				•	•
Gauze bandage 3.5 m x 7 cm - box of 10 (34841)				•		•	•		•				•	•
Sterile adhesive dressing 10 x 10 cm - box of 6 (34851)				•		•	•		•				•	•
Oxy-4 fingertip oximeter (35092)						•	•		•				•	•
Instant ice - bag 3 pcs. (34111)						•	•		•				•	•
Burn dressing - 10x10 cm (34871)								•			•	•		•
3 E3 padded pouches with window red (27188), blue (27189), green (27191)									•					
2 E4 pouches with window red (27192), yellow (27194)									•					

INTUBATION BAG WITH EMERGENCY ACCESSORIES

- 27133 INTUBATION BAG - empty
 - 34152 INTUBATION KIT - complete
 - 34153 INTUBATION KIT F.O. - complete
- Compact nylon bag suitable for various uses: 2 internal zip pockets, 9 elastic retainers for instruments, made in water-resistant anti-scratch 600D polyester, blue colour. Size: 32x22.5xh 7.5 cm.

STANDARD ACCESSORIES	34152	34153
Mc-Intosh Laryngoscope s/s blades N 1, 2, 3	3	3 F.O.
Laryngoscope metal handle	1	1
Magill forceps	1	2
Tongue holding forceps	1	1
Guedel cannula	3	5
Mouth opener	1	1
Scissors cm 14.5	1	1
Endotracheal tubes	-	4



MEDICATION FIRST AID BAG

- 27132 MEDICATION FIRST AID BAG - empty - 31x22x11 cm
 - 34149 MEDICATION FIRST AID BAG - filled
- First aid bag provided with 2 internal transparent pockets, one external pocket, internal division with 2 zip on both sides, handle and carrying belt.

- STANDARD ACCESSORIES**
- London palm sphygmomanometer (32725)
 - Yton single head stethoscope (32514)
 - Delta Led pen light (25629)
 - Fast tourniquet (25728)
 - Digital thermometer (25560)
 - Sterile adhesive dressing 10x10 cm - box of 6 (34851)
 - Liester bandage scissors - 15 cm (34129)
 - CPR mask (34218)
 - Disinfectant wipes
 - 3M Steri strips (34915 - 34916 - 34917 - 34918)
 - Emergency cover (34085)



GIMA RESUSCITATION KITS

- 34181 SPEED 1 RESUSCITATION KIT - UNI cylinder
- 34182 SPEED 2 RESUSCITATION KIT - NF cylinder
- 34183 SPEED 3 RESUSCITATION KIT - without cylinder
- 34180 SPEED EMPTY CASE - with sponge
- 34222 FACEMASK N° 2 - child small



First aid kits for reanimation, very useful for medical and dental rooms, sport clubs, factories, ambulances... Case made of anti-shock plastic. Size: 43 x 37 x 11 cm.

STANDARD ACCESSORIES	SPEED 1	SPEED 2	SPEED 3
Silicone resuscitation bag - autoclavable	•	•	•
Silicone Face mask n° 4	•	•	•
Oxygen cylinder 0.5 l (empty). UNI standard	•	•	•
Oxygen cylinder 0.5 l (empty). NF standard	•	•	•
High pressure manometer	•	•	•
Guedel airways (small + medium + large)	•	•	•
Helicoidal mouthwedge + Tongue holding forceps	•	•	•
Atoxing tubing for connection to oxygen cylinder	•	•	•
Plastic case	•	•	•



34181

SPLINTER REMOVAL KIT



Small metallic splinters, eye tool remove

Anti-abrasive nylon loop

34192

"NEODIMIO" magnetic point

The body is made of anodised aluminium and the neoprene seals guarantee a better pencil hold. Supplied in a box and CE marked.

34190

• 34190 SPLINTER REMOVAL KIT

Includes everything to remove splinters and for first aid medications. In a polypropylene box size 235x190x43 mm:

- 1 Eye wash solution 100 ml with an eye glass
- 1 magnifying glass, 2 sterile gauze pads 18x40 cm
- 1 Professional removal pencil, 1 mirror.
- 1 stainless steel tweezers 11.5 cm

• 34192 PROFESSIONAL REMOVAL PENCIL

Small metallic splinters eye tool remover. On one side a magnetic point to remove any metallic splinter avoiding any risk for the eye. On the other side an antiabrasive nylon loop for non metallic splinters.

EYE WASH SYSTEMS

• 34889 DROP - eye wash station

Thermo-formed wall kit with all necessary items for an efficient first emergency eye wash:

- 2 sterile saline solutions of 500 ml
- 2 integrated eye cups and one mirror.
- 34888 EYE WASH SOLUTION 500 ml
- sterile - spare



34889

FIRST AID FAMILY CASE



Case in polypropylene

Guidance in: GB, FR, IT, ES, DE, TR

Size: 235x190x43 mm

34136

• 34136 FAMILY FIRST AID CASE

Small first aid case suitable for use anywhere and anytime: (at home or office, in the car or boat...). Made in Italy

• 34450 EMPTY CASE

STANDARD ACCESSORIES

- | | |
|--|------------------------------------|
| 2 sterile gauze pads 18x40 cm | 3 antiseptic wipes |
| 1 pair of scissors. 1 plastic tweezers | 1 adhesive dressing 10 x 6 cm |
| 1 sterile bandage 60x40 cm | 1 gauze bandage 5 cm |
| 1 cotton wool pack 5 g | 1 adhesive plaster roll 2 cm x 1 m |
| 1 pack of 10 adhesive plasters | 1 pair of protection gloves |
| 1 tissue pack 10 pcs | Guidance Leaflet 6 languages |

MEDICAL SPORT BAG



• 34135 MEDICAL SPORT BAG

Special kit designed for first aid in sporting clubs (tennis clubs, swimming pools, gymnasium,....).

Soft nylon bag has 2 side pockets and zip closure.

Size: 470x240x190 mm
Weight: 6.5 kg

STANDARD ACCESSORIES

- | | |
|---|---|
| 1 isothermic blanket Gold/Silver 160x210 cm | 1 pack of 20 adhesive plasters 2x7 cm |
| 1 Disinfectant liquid 250 ml | 8 adhesive plasters 10x6 cm |
| 2 adhesive plasters 5 m x 2,5 cm | 1 sterile TNT bandage 60x40 cm |
| 2 pairs of sterile gloves | 1 elastic TNT bandage 60x80 cm |
| 2 VENTO mouth to mouth resuscitators | 6 sterile TNT pads 10x10 cm |
| 6 sterile gauze pads 18x40 cm | 5 instant ice packs |
| 2 instant ice sprays 150 ml | 1 hydrogen peroxide solution |
| 3 triangular TNT bandages 96x96x136 cm | 1 elastic net bandage |
| 3 Elastic bandages 6 cm | 1 haemostatic lacet |
| 3 Elastic bandages 8 cm | 1 sterile tweezers |
| 1 cotton wool pack | 5 ammonia towelettes |
| 1 pair of LISTER scissors 14,5 cm | 1 sterile saline solution bottle 250 ml |
| 2 compressive pad bandages 80x100 mm | 1 gel hands disinfectant 100 ml |
| 2 compressive pad bandages 100x120 mm | guidance leaflet 5 languages |

FIRST AID CASE AND BAG



• 34184 SMALL KIT - plastic case

Size: 290x215x90 mm - 1.4 kg
See content of kit at page 334

• 34188 REFILL PACK for 34184-34185-34194

• 34186 EMPTY PLASTIC CASE 290x215x90 mm

• 34185 MIZAR BAG - nylon
Size: 250x180x90 mm

Same contents as 34184 see page 334

34185



34184

Advised for offices or workshops of 2 people
Meets Italian law 388-Art. 2

FIRST AID PLASTIC CASES AND METAL CABINETS



34196



34197

- 34196 MEDIUM KIT - plastic case Size: 275x240x123 mm - 2 kg
- 34197 MEDIUM KIT - metal cabinet Size: 370x300x140 mm - 3.8 kg
- 34187 REFILL PACK for code 34196-97
- 34141 EMPTY METAL CABINET 370x300x140 mm



34195



34199

- 34195 LARGE KIT - plastic case 1 Size: 460x345x135 mm - 6.2 kg
- 34198 LARGE KIT - plastic case 2 Size: 395x270x135 mm - 6.2 kg
- 34199 LARGE KIT - metal cabinet Size: 460x300x140 mm - 7.5 kg
- 34189 REFILL PACK for code 34195-34198-34199 without sphygmomanometer
- 34191 EMPTY PLASTIC CASE 1 460x345x135 mm
- 34138 EMPTY PLASTIC CASE 2 395x270x135 mm



- 34143 METAL CABINET
Supplied with 3 internal metal shelves, removable bottle floor support, 2 small shelves on the door, lock and key.
Size 402x582x202 mm - 12.9 kg
- 34145 EMPTY METAL CABINET 402x582x202 mm

STANDARD CASES / CABINETS CONTENT	34194 34184-5	34196 34197	34195 34198-9	34143	34151	SPARES see page
Bags liquid soap		3		3		348
Bags antiseptic wipes		3		3		349
Bottle antiseptic solution 125 ml	1	1				-
Bottle antiseptic solution 250 ml				1		349
Bottle antiseptic solution 500 ml			2	3	2	-
Oxygenated water bottle				1		349
Ammonia bag		2		2		-
Pair protective gloves, sterile	2	2	5	5	5	19
Box of 10 assorted plasters	1	1	2		2	345
Box of 100 assorted plasters Plastosan				1		345
Box of 100 assorted 7x2 cm Plastosan				1		345
Adhesive plaster roll 2,5 cm x 5 m	1	1	2	2	2	343
Elastic bandage with clip 4,5 cm x 7 m				1		339
Pack of 8 assorted gauze bandages				1		339
Gauze bandage 10 cm x 3,5 m	1	1				339
Tubular net gauze			1	1	1	336
Pack of sterile compress 10 x 10 cm	3	3	10	10	10	341
Pack of sterile compress 18 x 40 cm	1	3	2	6	2	341
Pack of cotton wool	1	1	1	3	1	342
Mask with face shield			1	1	1	16
Pair of scissors cm 14,5	1	1	1	1	1	335
Sterile forceps	1	1	2	2	2	38
Haemostatic lacet	1	1	3	3	3	56
Sphygmomanometer + Stethoscope			1	1	1	229-250
Sterile blanket 40x60 cm		1	2	2	2	-
Pack of instant ice, single use	1	1	2	2	2	347
Digital thermometer			1	1	1	78
Trash bag	1	1	2	5	2	-
First aid multilanguage booklet	1	1	1	1	1	-
Guidance leaflet	1	1	1	1	1	-
Irrigating solution 250 ml	1	1				349
Irrigating solution 500 ml			3	3	3	-
Triangular blanket 96x96x136 cm		1		4		-
Isothermic blanket gold/silver 160x210 cm				1		347
Sterile burn gel sachet 3.5 g				3		347
Compressive Emocontrol bandage				1		339
Pinocchio helicoidal open mouth Vento				1		324
Autoclavable resuscitator with facemask N° 4					1	322
Oxygen bottle 0.5 l empty - UNI standard					1	320
Guedel airways					3	323
Atoxic tube for oxygen					1	324
Mouth opener					1	324

- 34151 GIMA 3 - FIRST AID CASE + OXYGEN CYLINDER
Advised for up to 50 people Size: 32x44.5x15 cm
Meets Italian law D.M. 388 (15.7.03) art. 1 + emergency kit.
Emergency kit includes:
- autoclavable resuscitation with security valve, and silicone mask n. 4.
- oxygen bottle 0.5 l (empty) with reductor and oxygen distributor - UNI standard.
- 3 guedel airways, atoxic tube for connection to oxygen, mouth opener and wall support.



34151



34148

- 34148 GIMA 3 - EMPTY PLASTIC CASE

MASK FOR MOUTH-TO-MOUTH REANIMATION



Ambu
Ideas that work for life

• **34216 LIFEKEY MASK**
Pocket mask for mouth-to-mouth reanimation. Its special one-direction valve allows oxygen to flow straight to the patient and minimizes risks of cross-contamination. Single-use, non sterile, made in atoxic transparent material, easy to use and carry. Suitable for adults and children.



GIMA

• **34218 CPR MASK - pocket resuscitator**
The CPR pocket mask is a non-invasive, latex free mask with an integral non-rebreathing valve and efficient filter to prevent direct mouth contact with the patient's face when providing mouth-to-mouth resuscitation. It can be used on adult, child and infant. Supplied in a compact plastic box with a corrugated tube for an easier use.



• **34211 VENTO AIRWAYS - Poly-bag**
• **34213 VENTO AIRWAYS - Key-holder box**
Disposable mouth to mouth airway with a one way polycarbonate valve and non-toxic pvc protective foil to avoid any direct contact between patient and rescuer. Available in 2 versions: in poly-bag or key-holder box. Instructions in GB, IT, FR, DE.

EMERGENCY

Supplied with transport bag



34127

Weight: 540 g

• **34127 EMERGENCY SCISSORS**
23.5x10.8 cm
Autoclavable Stainless steel AISI 420. Made in Italy.

LISTER BANDAGE S/S SCISSORS



LISTER BANDAGE SCISSORS			
code	STAINLESS STEEL	GIMA code	FANTASY - COLOURED RING
34125	Lister - 11 cm	20501	Lister - Green ring - 14 cm
34129	Lister - 15 cm	20502	Lister - Lilac ring - 14 cm
34130	Lister - 18 cm	20509	Lister - Foot print - 14 cm
20500	Lister with belt clip - 14 cm	20511	Lister - Leropard - 14 cm
38530	Lister tungsten carbide - 14 cm	20512	Lister - Bubble - 14 cm
38532	Lister tungsten carbide - 18 cm	20513	Lister - Hearts - 14 cm

STAINLESS STEEL UTILITY AND BANDAGES SCISSORS



20581 20582 20573 20574 20560

Plastic coloured finger-contour handles for maximum comfort.

All purpose, first aid scissors, easily cut bandages, leather and plaster casts. Autoclavable at 136°C

UTILITY SCISSORS			
12 cm - 4.7"	16.5 cm - 6.5"	19 cm - 7.5"	Colour
20560	20570	20580	Black
-	20571	20581	Blue
-	20572	20582	Red
-	20573	20583	Purple
-	20574	20584	Pink
20590	Steel chain for scissors and forceps		



20590

LEUKOTAPE® K NEUROMUSCULAR TAPE



NEUROMUSCULAR TAPE

Elastic adhesive tape for neuromuscular taping. 100% cotton fabric coated with a strong acrylic adhesive mass. Water resistant. Latex-free. Multilanguage GB, FR, IT, ES, DE, PT, NL.



code	BSN code	LEUKOTAPE® K NEUROMUSCULAR TAPE
59010	72978-11	LEUKOTAPE® K 5 m x 5 cm - skin
59011	72978-16	LEUKOTAPE® K 5 m x 5 cm - red
59012	72978-21	LEUKOTAPE® K 5 m x 5 cm - blue
59013	72978-23	LEUKOTAPE® K 5 m x 5 cm - black
59014	72978-24	LEUKOTAPE® K 5 m x 5 cm - light blue
59015	72978-25	LEUKOTAPE® K 5 m x 5 cm - pink

KINTAPE KINESIOLOGY TAPES

High quality Kinesiology tape conforms to all areas of the body. Provides firm support and compression. Ideal for treatment of muscular symptoms, stimulus to blood circulation and lymph and fascia diversion. Reduce pain improving athletic performance. Easy to tear and unwinds to the core. Individually packed in a plastic bag and cardboard box. - soft hypoallergenic cotton cloth, elasticity up to 160%

- 70% water proof (level 3) and sweat proof
- supersticky: up to 7 days, over 10 days for kinesiology PRO
Kinesiology PRO: supersoft and quick drying

code	KINESIOLOGY STANDARD TAPES - thickness 0.48 mm	Minimum order
34745	Kinesiology tape 5 m x 5 cm - black	box of 1
34746	Kinesiology tape 5 m x 5 cm - ceil blue	box of 1
34747	Kinesiology tape 5 m x 5 cm - red	box of 1
34749	Kinesiology tape 5 m x 5 cm - green	box of 1
34750	Kinesiology tape 5 m x 5 cm - pink	box of 1
34751	Kinesiology tape 5 m x 5 cm - skin	box of 1
34752	Kinesiology tapes 5 m x 5 cm - mix colours	box of 6
KINESIOLOGY PRO TAPES - thickness 0.32 mm		
34757	Kinesiology PRO tapes 5 m x 5 cm - skin	box of 1

Mixed colours box includes 6 rolls in different colours: ceil blue, red, pink, green, black, beige



Multilanguage box and instructions (GB, FR, IT, ES)

Made of 97% cotton, 3% spandex

34752

FABRIC SPORT TAPES



34755

34754



Made in Italy

code	WHITE ZINC OXIDE FABRIC TAPE NON ELASTIC ADHESIVE BANDAGE	Minimum order
34753	Tape 14 m x 2.5 cm - for finger	box of 48
34754	Tape 14 m x 3.8 cm - for wrist	box of 30
34755	Tape 14 m x 5 cm - for ankle	box of 24

ELASTICATED TUBULAR NET

Elastic tubular net for the application of gauze and medication. Versatile, suitable for all parts of the body. The special structure of the material allows a stretching which holds without compressing. Made in Italy.



code	Range	Length under tension: 25 m
34701	1	4
34702	2	7 small
34703	3	8 medium
34704	4	9 large
34705	5	
34706	6	
34707	7	
34708	8	
34709	9	



STRAPPAL® SPORT TAPE

STRAPPAL® SPORT TAPE

Inelastic adhesive bandage (tape) indicated in traumatology to limit the joint movements.

High quality fabric made of inelastic viscose fibres coated with a strong adhesive mass. Hand tearable. Latex free.

Multilanguage GB, FR, IT, ES, DE, PT, NL.



code	BSN code	STRAPPAL® SPORT TAPE	Minimum order
59051	71490-00	STRAPPAL® 10 m x 4 cm	box of 24
59052	71493-00	STRAPPAL® 10 m x 5 cm	box of 18



COMPRILAN® COMPRESSIVE BANDAGES



COMPRILAN® COMPRESSIVE BANDAGES
Short stretch compression bandage (90%) for phlebological and lymphological application. 100% cotton fabric (flesh colour). Stretched length 5 m. Washable and sterilizable. Latex-free.

code	BSN code	COMPRILAN® COMPRESSIVE BANDAGES	Minimum order
59150	01026-00	COMPRILAN® 5 m x 6 cm	box of 1
59151	01027-00	COMPRILAN® 5 m x 8 cm	box of 1
59152	01028-00	COMPRILAN® 5 m x 10 cm	box of 1
59153	01029-00	COMPRILAN® 5 m x 12 cm	box of 1

ELASTIC COMPRESSION BANDAGES - LIGHT TO STRONG COMPRESSION



PREVIBIELASTICA
- medical prescription bandage
- ideal for bandaging when support and strong, constant compression is required
- used in the treatment of varicose veins and post-operative patients
- its ability to stretch in any direction makes it ideal for bandaging joints.



PREVIFORTE
- medical prescription bandage
- compression bandage for phlebitis treatment
- support bandage with strong, constant compression, ideal for varicose veins, for the prevention and cure of sport and work injuries. Suitable for distortions, light fractures and sprains.

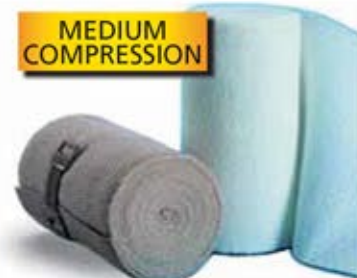

PREVINOVA
- universal compression bandage
- protects and supports all types of medication
- to fix medications, support light fractures, distortions, sprains, sport and work injuries with medium compression.



PREVIMEDICAL
- universal compression bandage
- protects and supports all types of medication
- to fix medications, for support and relief in case of contusions and haematomas with medium-light compression.

TECHNICAL SPECIFICATIONS					
	PREVI BIELASTICA	PREVI FORTE	PREVI NOVA	PREVI MEDICAL	
Composition:	Cotton 70%	polyamide 19%	polyurethane 11%	longitudinal 160%	transversal 80%
Extensibility	70%	92%	69%	60%	
	19%	-	25%	33%	
	11%	8%	6%	7%	
	160%	170%	250%	160%	
	80%	-	-	-	

code	ELASTIC COMPRESSION BANDAGES individually packed, with clip	Minimum order
PREVIBIELASTICA - strong compression		
34644	PreviBielastica 7 m x 8 cm	box of 10
34645	PreviBielastica 7 m x 10 cm	box of 10
PREVIFORTE - strong compression		
34647	PreviForte 7 m x 8 cm	box of 10
34648	PreviForte 7 m x 10 cm	box of 10
PREVINOVA - medium compression		
34650	PreviNova 4.5 m x 6 cm	box of 10
34651	PreviNova 4.5 m x 8 cm	box of 10
34652	PreviNova 4.5 m x 10 cm	box of 10
PREVIMEDICAL - medium light compression		
34654	PreviMedical 5 m x 8 cm	box of 10
34655	PreviMedical 5 m x 10 cm	box of 10

CO-PLUS® BANDAGES



CO-PLUS® BANDAGES
Flexible cohesive bandage. Sticks only to itself, not on skin. Indications: support and compression in traumatology and phlebology. Longer than competitors (6.3 m stretched instead of 4.5 m). Multilanguage box: GB, FR, IT, ES, DE, NL.

code	BSN code	CO-PLUS® BANDAGES	Minimum order
59182	72100-09	CO-PLUS® 6.3 m x 7.5 cm - skin	box of 1
59183	72100-04	CO-PLUS® 6.3 m x 10 cm - skin	box of 1
59186	72102-03	CO-PLUS® 6.3 m x 7.5 cm - mix colours*	box of 24
59187	72102-02	CO-PLUS® 6.3 m x 10 cm - mix colours*	box of 18

*Mix of bandages in 6 colours (blue, light blue, red, violet, neon green, neon pink)

3M COBAN™ ELASTIC WRAP



code	3M code	3M COBAN™ SELF ADHERENT COHESIVE ELASTIC WRAP - LATEX	Minimum order
34923	1583	COBAN™ 7.5 cm x 2 to 4.57 m	box of 24
34924	1584	COBAN™ 10 cm x 2 to 4.57 m	box of 18

ELASTOMULL® HAFT COHESIVE BANDAGES



Multilanguage box:
GB, FR, IT, ES, DE,
PT, NL, SE

ELASTOMULL® COHESIVE BANDAGES
Elastic retention bandage. It provides wound care splint retention and light support. Comfortable non woven fabric (cotton, viscose and polyamide) coated with synthetic latex. Stretched length 4 m.



code	BSN code	ELASTOMULL® HAFT COHESIVE BANDAGES	Minimum order
59211	45471-00	Elastomull® Haft 4 m x 6 cm	box of 10
59212	45472-00	Elastomull® Haft 4 m x 8 cm	box of 10
59213	45473-00	Elastomull® Haft 4 m x 10 cm	box of 10
59214	45474-00	Elastomull® Haft 4 m x 12 cm	box of 10
59218	45477-00	Elastomull® Haft 20 m x 8 cm	box of 1
59219	45478-00	Elastomull® Haft 20 m x 10 cm	box of 1

ELASTIC COHESIVE BANDAGES



- to fix dressings.
- ideal for supporting light joint fractures.
- this bandage does not require clips because perfectly adherent.

TECHNICAL SPECIFICATIONS

Composition: 42% cotton, 29% viscose, 29% polyamide, latex or latex free
Width: 6 - 8 - 10 - 12 cm
Length: stretched length 4 m
Extensibility: approx. 50%

code	ELASTIC COHESIVE BANDAGE	Minimum order
34657	Cohesive bandage 4 m x 6 cm	box of 10
34658	Cohesive bandage 4 m x 8 cm	box of 10
34659	Cohesive bandage 4 m x 10 cm	box of 10
34660	Cohesive bandage 4 m x 12 cm	box of 10
34661	Cohesive bandage 20 m x 6 cm	box of 1
34662	Cohesive bandage 20 m x 8 cm	box of 1
34663	Cohesive bandage 20 m x 10 cm	box of 1

code	ELASTIC COHESIVE BANDAGE - LATEX FREE	Minimum order
59201	Cohesive bandage 4 m x 8 cm	box of 10
59202	Cohesive bandage 4 m x 10 cm	box of 10
59206	Cohesive bandage 20 m x 8 cm	box of 1
59207	Cohesive bandage 20 m x 10 cm	box of 1

COHESIVE BANDAGES

ELASTIC COHESIVE BANDAGES

Cohesive bandage with instantaneous and lasting fixation. It adheres only to itself and not to the skin, hair or clothing. Doesn't slip, is air-permeable, with stretchability of approx 115%. Comfortable, well tolerated by skin, it adapts perfectly to part to be treated. Versatile to use, easy to apply, permits free movement. Made in Italy.



code	COHESIVE BANDAGE	Minimum order
34710	Cohesive bandage size 4 m x 6 cm	box of 72 pcs
34711	Cohesive bandage size 4 m x 8 cm	box of 72 pcs
34712	Cohesive bandage size 4 m x 10 cm	box of 36 pcs
34713	Cohesive bandage size 4 m x 12 cm	box of 36 pcs

ELASTIC COLOUR COHESIVE BANDAGES - EXTENSIBILITY 90%

Cohesive bandages through microfine latex dots

- for fixing dressings
- ideal for supporting joint treating light fractures
- this bandage does not require clips because it remains well-attached to itself.

TECHNICAL SPECIFICATIONS

Composition: 42% cotton, 29% viscose, 28% polyamide, 1% elastan and latex
Width: 6 - 8 - 10 cm Length: stretched length 4 m
Extensibility: approx. 90%

COHESIVE COLOUR BANDAGE

Size	Green	Blue	Red	Yellow	Colours*	Minimum order
4 m x 6 cm	-	34665	34666	-	34668	box of 10
4 m x 8 cm	34669	34670	34671	34672	34673	box of 10
4 m x 10 cm	34674	34675	34676	-	34678	box of 10

*Mix 2 bandages x 5 colours (red, green, blue, yellow, white)



Cohesive through microfine latex dots

PREVITNT COHESIVE NON WOVEN ELASTIC BANDAGES

PREVITNT NON WOVEN ELASTIC BANDAGES

For fixing dressings. Ideal for supporting joints, treating light fractures. This bandage does not require clips because it remains well-attached to itself. Particularly suitable for use on joints, for sports and veterinary use. Composition: 85% polypropylene - 15% spandex and latex. Extensibility: approx 100%.

COHESIVE COLOUR NON WOVEN BANDAGE

Size	Blue	Red	Colours*	Minimum order
4.5 m x 7.5 cm	34734	34735	34736	box of 10
4.5 m x 10 cm	34738	34739	34740	box of 10

*Mix 2 bandages x 5 colours (red, green, blue, yellow, skin)



TENSOPLAST® ELASTIC ADHESIVE BANDAGES



TENSOPLAST® BANDAGES
Elastic adhesive bandage. High quality elastic fabric, soft edges and porous adhesive mass. Yellow center line. It provides strong support and compression in traumatology and phlebological disease. Stretched length 4.5 m. Multilanguage box: GB, FR, IT, ES, DE, PT, GR, NL, SE.



code	BSN code	TENSOPLAST® BANDAGES
59250	71545-00	TENSOPLAST® 4.5 m x 5 cm
59251	71546-00	TENSOPLAST® 4.5 m x 7.5 cm
59252	71547-00	TENSOPLAST® 4.5 m x 10 cm

GAUZE BANDAGES

For fixing dressing and for absorption of exudates. 100% cotton wool. Latex free. Made in Europe.



code	Threads	GAUZE BANDAGES - DISPOSABLE	Minimum order
34840	20	Gauze bandage 3.5 m x 5 cm	box of 12
34841	20	Gauze bandage 3.5 m x 7 cm	box of 10
34842	20	Gauze bandage 3.5 m x 10 cm	box of 6
34844	20	Gauze bandage 5 m x 5 cm	box of 100
34846	20	Gauze bandage 5 m x 7 cm	box of 100
34847	20	Gauze bandage 5 m x 10 cm	box of 100

FIXATION ELASTIC BANDAGES

For fixing dressing, for support and light compression. Its characteristic crepe like touch enables the bandage to remain well-attached to itself. Well-tolerated by the skin, it ensures a high level of breathing. Washable at 60°C. Made of 99% cotton - 1% lycra. Made in Europe.



code	PREVICREPE S FIXATION ELASTICATED BANDAGES - 75 g ²	Minimum order
34725	Previcrepe bandage 4 m x 5 cm	box of 10
34726	Previcrepe bandage 4 m x 7 cm	box of 10
34727	Previcrepe bandage 4 m x 10 cm	box of 10
34728	Previcrepe bandage 4 m x 15 cm	box of 10

ELASTICATED BANDAGES

Elasticated **non adhesive** bandages for containment, individually cellophane wrapped, in a box. Non adhesive bandages are made of 65% cotton and 35% polyamide fibre. Provided with clasp. Made in Italy.



code	ELASTICATED BANDAGES	Minimum order
34720	Bandage size 4.5 m x 5 cm	box of 20 pcs
34721	Bandage size 4.5 m x 7 cm	box of 20 pcs
34722	Bandage size 4.5 m x 10 cm	box of 20 pcs

ELASTICATED ADHESIVE BANDAGES

Elasticated **adhesive** bandages for containment, individually cellophane wrapped, in a box. Adhesive bandages are made of 99.7% cotton and 0.3% polyamide. Made in Switzerland.



code	ELASTICATED ADHESIVE BANDAGES
34730	Adhesive bandage size 4.5 m x 6 cm
34731	Adhesive bandage size 4.5 m x 8 cm
34732	Adhesive bandage size 4.5 m x 10 cm

HYPOR-PLAST

Extensible adhesive bandage
White extensible non-woven 100% polyester bandage roll. Extremely breathable and conformable. Hypoallergenic, reliable skin friendly acrylic adhesive. **Indications:** suitable to fix dressings and other medical devices.



code	EXTENSIBLE ADHESIVE BANDAGE
34863	roll m 10 x 5 cm
34864	roll m 10 x 10 cm
34865	roll m 10 x 15 cm

EMOCONTROL

• **34782 EMOCONTROL**
Emocontrol is an easy, quick and effective elastic bandage for injuries and small haemorrhages. Length 4.5 m, width 10 cm with a 10x10 cm pad and 2 clips. English and Italian instructions. Made in Italy.



ZINC-OINTMENT BANDAGE

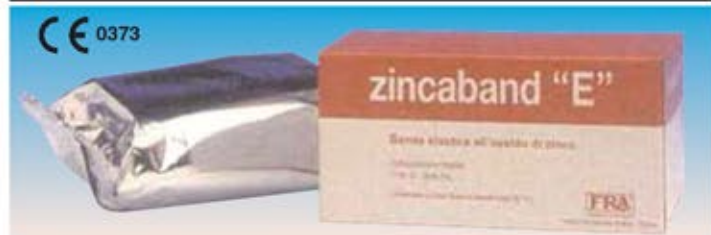

- 34715 ZINC-OINTMENT ELASTIC BANDAGE 5 m x 10 cm
 - 34717 ZINC-OINTMENT ELASTIC BANDAGE 10 m x 10 cm
- Homogeneously soaked in zinc ointment ready for use and stretchable (in length).
Each band is packed in sealed aluminium foil bag and cardboard box.
Made in Italy.

TEXTILE COMPOSITION

Viscose 71% - Polyamide 29% - Soaked with zinc oxide, gelatine, glycerin, propyl-hydroxybenzoate, methyl-hydroxybenzoate, water. Elasticity: 60% (±10%)

PREVIZINC A and E



Previzinc "A" and "E" are bandages impregnated with zinc oxide paste indicated in the treatment of thrombophlebitis, oedema, chronic venous insufficiency and in the healing phase and follow-up care of fractures, sprains and strains.

code	PREVIZINC "A" INELASTIC BANDAGES	Minimum order
34714	Previzinc "A" 6 m x 8 cm	box of 10
34716	Previzinc "A" 5 m x 10 cm	box of 10
PREVIZINC "E" ELASTIC BANDAGES		
34718	Previzinc "E" 6 m x 8 cm	box of 10
34719	Previzinc "E" 5 m x 10 cm	box of 10

TEXTILE COMPOSITION

Previzinc A: 100% cotton zinc oxide paste
Previzinc E: 54% polyamide, 46% viscose zinc oxide paste

PLATRIX® HIGH QUALITY PLASTER OF PARIS BANDAGES



PLATRIX® PLASTER OF PARIS
High quality plaster of Paris bandages. Economic thanks to the high strength and the minimal plaster loss.
Multilanguage box: GB, FR, IT, ES, DE, NL.

code	BSN code	PLATRIX® PLASTER OF PARIS	Minimum order
34686	71996 - 05	Platrix® 2 m x 15 cm	box of 40
34688	71996 - 14	Platrix® 3 m x 20 cm	box of 20
34691	71996 - 28	Platrix® 4 m x 20 cm	box of 20

P.O.P. (PLASTER OF PARIS) BANDAGES

PLASTER OF PARIS BANDAGES

Absorbent 100% cotton gauze 170 threads/cm² complying with British Pharmacopoeia requirements.

code	CELLONIT - PLASTER OF PARIS BANDAGE	Minimum order
34692	P.O.P. Bandage 2 m x 10 cm	box of 100
34693	P.O.P. Bandage 2 m x 15 cm	box of 50
34694	P.O.P. Bandage 2 m x 20 cm	box of 50
34695	P.O.P. Bandage 2.7 m x 10 cm	box of 80
34696	P.O.P. Bandage 2.7 m x 15 cm	box of 40
34697	P.O.P. Bandage 2.7 m x 20 cm	box of 40



Individually packed in a plastic bag and cardboard box

OSCILLATING PLASTER SAW



- 59100 SG - 600 PLASTER SAW
- 59101 SAW BLADE Ø 50 mm
- 59102 SAW BLADE Ø 65 mm

German made professional plaster saw, ideal for cutting plasters and synthetic bandages. Adjustable oscillating speed.

STANDARD ACCESSORIES

Saw blade Ø 50 mm
Saw blade Ø 65 mm
One pair of wrenches
Locking screw
Fixation ring
User manual: GB, IT, ES
(DE on request)

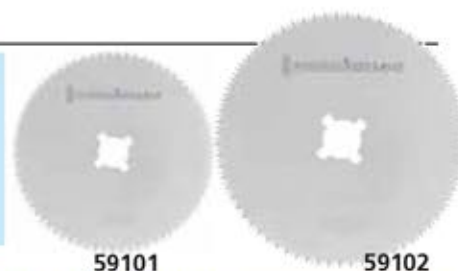

59101

59102

TECHNICAL SPECIFICATIONS

Voltage:	220-240 V, 50-60 Hz
Power:	250 W
Strokes:	12,000 - 21,000 oscillations/min
Length without cord:	340 mm
Weight with/without cable:	1.3/1.7 Kg
Noise:	68-82 dB
Cord length:	4.5 m
IP code:	IP2X

COTTON GAUZE SWABS



CE 0373

34772

34790-1-2

code	Plies	Threads	GAUZES - NON STERILE	Minimum order
34770	16	20	Cotton gauze swab 5x5 cm	pack of 100
34771	16	20	Cotton gauze swab 7.5x7.5 cm	pack of 100
34772	16	20	Cotton gauze swab 10x10 cm	pack of 100
34773	12	20	Cotton gauze swab 10x20 cm	pack of 150
34790		20	Cotton gauze pad 10x10 cm - 1 kg	1 pack
34791		20	Cotton gauze pad 20x20 cm - 1 kg	1 pack
34792		20	Cotton gauze pad 30x30 cm - 1 kg	1 pack

GAUZE SWABS: COTTON, NON-WOVEN

Gauze swabs pure cotton, 20 threads, yarn 40/40, folded and hemmed without X-ray thread, non-sterile.
Non woven swabs, 30% polyester, 70% viscose 30 g/m² folded and hemmed without X-ray thread.
Carton of 10 packs of 100.



Cotton	Plies	Non Woven	Plies	GAUZE SWABS NON STERILE	Minimum order
35005	16	35010	4	Size 5x5 cm	box of 1,000 (10 packs of 100)
35006	12	35011	4	Size 7.5x7.5 cm	box of 1,000 (10 packs of 100)
35007	16	35012	4	Size 10x10 cm	box of 1,000 (10 packs of 100)

COTTON GAUZE SWABS - STERILE



CE 0476

34762

34761

34760

34764

34763

code	Threads	COTTON GAUZE SWABS - STERILE Made in Italy	Minimum order
34760	12/8	Size 10x10 cm	carton of 150 bags of 25 pcs
34761	12/8	Size 15x15 cm	carton of 100 bags of 25 pcs
34762	12/8	Size 20x20 cm	carton of 100 bags of 25 pcs
34763	12/8	Size 18x40 cm	carton of 50 box of 12 pcs
34764	12/8	Size 36x40 cm	carton of 50 box of 12 pcs

NON WOVEN GAUZE SWABS - STERILE



CE 0476

35025

35028

35029

code	NON WOVEN GAUZE SWABS - STERILE Made in Italy	Minimum order
35025	Size 10x10 cm	carton of 100 bags of 25 pcs
35028	Size 18x40 cm	carton of 30 box of 12 pcs
35029	Size 36x40 cm	carton of 30 box of 12 pcs

COTTON GAUZE SWABS - STERILE



100% cotton gauze, 17 threads / 59 cm², according to European Pharmacopoeia and EN 14079. Each dispenser contains sterile packs of 5 gauze swabs.

CE 0373

35035

35037

35039

35038

code	Plies	Threads	GAUZE SWABS - STERILE	Minimum order
35035	12	17	5x5 cm	dispenser of 350 (70 packs of 5 swabs)
35036	12	17	5x5 cm - X-ray	dispenser of 350 (70 packs of 5 swabs)
35037	12	17	7.5x7.5 cm	dispenser of 250 (50 packs of 5 swabs)
35038	12	17	7.5x7.5 cm - X-ray	dispenser of 250 (50 packs of 5 swabs)
35039	12	17	10x10 cm	dispenser of 150 (30 packs of 5 swabs)
35040	12	17	10x10 cm - X-ray	dispenser of 150 (30 packs of 5 swabs)

COTTON GAUZE BALLS - STERILE



CE 0373 100% cotton gauze, 20 threads / 59 cm² according to European Pharmacopoeia and EN 14079.
Each dispenser contains sterile packs of 5 gauze balls.

Pack of 5

code	Threads	GAUZE BALLS - STERILE	Minimum order
35045	20	Gauze balls Ø 30 mm	dispenser of 250 (50 pack of 5)
35046	20	Gauze balls Ø 40 mm	dispenser of 200 (40 pack of 5)
35047	20	Gauze balls Ø 50 mm	dispenser of 300 (60 pack of 5)

COTTON GAUZE BALLS



34780

code	COTTON GAUZE BALLS	Minimum order
34780	Cotton gauze balls Ø 30 mm	100 pcs. (1 bag of 100)
34781	Cotton gauze balls Ø 50 mm	100 pcs. (1 bag of 100)

COTTON GAUZE BALLS

Pure hydrophilic cotton gauze balls 20 threads, yarn 40/40, without X-ray thread, non sterile package. Carton of 10 bags of 100 balls.



35017

35016

35015

Cotton	Non Woven	GAUZE ROUND BALLS	Open size	Minimum order
35015	35020	Gauze ball Ø 15 mm	11x11 cm	1,000 pcs (10 bags of 100)
35016	35021	Gauze ball Ø 25 mm	12x15 cm	1,000 pcs (10 bags of 100)
35017	35022	Gauze ball Ø 50 mm	30x40 cm	1,000 pcs (10 bags of 100)

GAUZE LAPAROTOMIC SPONGE

100% cotton gauze according to the European Pharmacopoeia and EN 14079, non sterile. X-ray detectable apx 60% Barium Sulphate.



code	Plies	Threads	LAPAROTOMIC SPONGE GAUZE	Minimum order
34775	4	17	Size 20x20 cm	box of 100
34776	4	17	Size 30x30 cm	box of 100
34777	4	17	Size 40x40 cm	box of 100
34778	4	17	Size 50x50 cm	box of 100

DENTAL COTTON ROLLS

• 35000 COTTON ROLLS 1x3.8 cm
100% cotton interior, soft, pliable, non-linting, non-irritating, highly absorbent up to 6 times their weight. Will not adhere to mucous membranes, maintains shape better when wet, non sterile.
Minimum order: carton of 10 boxes of 1,000 pcs.



35000



100% COTTON WOOL



code	COTTON WOOL
34837	Cotton wool 100 g - box of 50 packs
34832	Cotton wool 250 g - box of 20 packs
34838	Cotton wool 1000 g - box of 10 packs

STERILE ABSORBENT PADS



Multilanguage box:
GB, FR, IT, ES,
PT, DE, NL, SE

Ideal for situations where a great capacity of absorption is needed, such as blendings and chronic wounds. Made of cellulose pulp, white and blue polypropilene and tissue paper.

GIMA code	STERILE ABSORBENT PADS	Minimum order
59402	10x10 cm	box of 60
59403	10x20 cm	box of 30
59404	20x20 cm	box of 30
59405	20x40 cm	box of 25

100% COTTON GAUZE ROLLS

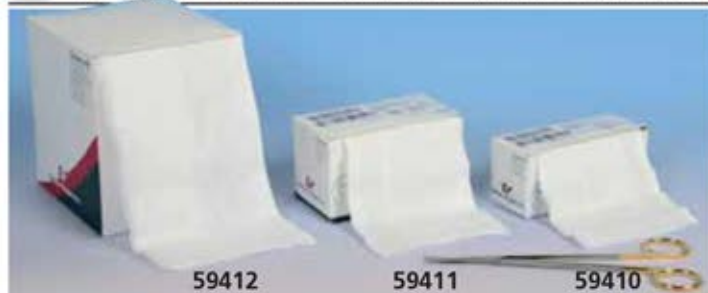

59412

59411

59410

GAUZE ROLLS

100% cotton gauze rolls with 20 threads sq cm according to European Pharmacopoeia and EN 14079. X-Ray detectable thread (approx. 60% barium sulphat) 80 cm width, folded 8 to 10 cm ply. Multilanguage box: GB, FR, IT, ES, PT, DE, NL, SE.

code	GAUZE ROLLS		Plies	Threads sq cm
	Extended width	Folded width		
59410	80 cm x 1 m	10 cm x 1 m	8	20
59411	80 cm x 2 m	10 cm x 2 m	8	20
59412	80 cm x 10 m	10 cm x 10 m	8	20

100% COTTON RIBBON GAUZE



- Latex and PVC free
- Absorption of fluids inside cavities
- Wound care during surgery

Multilanguage box:
GB, FR, IT, ES,
PT, DE, NL, SE

code	GIMA code	100% COTTON RIBBON GAUZE weight 33 g/sq. m 22 threads/sq. m	Minimum order
59420	59430	5 m x 1.25 cm	box of 24
59421	59431	5 m x 2.5 cm	box of 12
59422	59432	5 m x 5 cm	box of 12
59423	59433	5 m x 7.5 cm	box of 8
59424	59434	5 m x 10 cm	box of 6
59440	-	5 m x 1.25 cm - sterile	box of 60
59441	-	5 m x 2.5 cm - sterile	box of 30
59442	-	5 m x 5 cm - sterile	box of 26

*X-Ray: approx. 60% barium sulphat contents

3M RESTON™ FOAM PAD

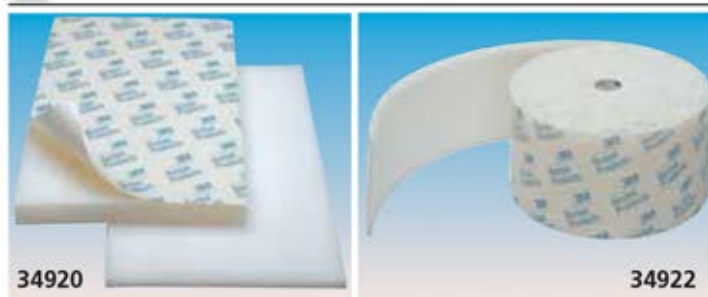

34920

34922

Self-adhering open cell foam designed to protect skin from splints, casts and prostheses. Not intended to be used as a pressure reducing device. It can also be used as a padding for beds and chairs. Can be cut, layered and shaped.



code	3M code	3M RESTON™ FOAM PAD	Minimum order
34920	1560	RESTON™ 30x20x1.1 cm	box of 10
34921	1561	RESTON™ 30x20x2.5 cm	box of 5
34922	1563	RESTON™ ROLL 10cmx5mx4mm	1 roll

ADHESIVE DRESSING



code	STERILE - NON WOVEN ADHESIVE WOUND DRESSING HYPOALLERGENIC	Minimum order
34860	Sterile adhesive dressing 5x7 cm	box of 100 pcs
34861	Sterile adhesive dressing 8x10 cm	box of 50 pcs
34862	Sterile adhesive dressing 8x15 cm	box of 50 pcs

STERILE ADHESIVE DRESSINGS



- **34848 OCULAR ADHESIVE DRESSING**
Sterile, extremely absorbent ocular dressing on hypoallergenic permeable adhesive backing. Suitable for a safe and comfortable eye medication. Size 6.5x9.5 cm - box of 10 pcs
- **34845 STERILE ADHESIVE DEVICE for cannula fixation**
Size 8x5.8 cm - box of 50 pcs

ADHESIVE DRESSINGS



code	STERILE HYPOALLERGENIC ADHESIVE DRESSING WITH CENTRAL NON-WOUND-STICKING ABSORBANT PAD	Minimum order
34850	Sterile adh. dressing 7.2x5 cm	box of 8 pcs
34851	Sterile adh. dressing 10x10 cm	box of 6 pcs
34852	Sterile adh. dressing 10x15 cm	box of 4 pcs
34853	Sterile adh. dressing 10x8 cm	box of 50 pcs
34854	Sterile adh. dressing 10x15 cm	box of 50 pcs

code	HYPOALLERGENIC EXTENSIBLE NON WOVEN ADHESIVE DRESSING TO BE CUT, WITH HIGHLY ABSORBENT CENTRAL WOUND PAD	Minimum order
34855	Size 1 m x 6 cm	1 roll
34856	Size 5 m x 6 cm	1 roll

Recommended for sensitive skin

BWT ADHESIVE DRESSING



code	STERILE HYPOALLERGENIC ADHESIVE DRESSING WITH CENTRAL NON-WOUND-STICKING ABSORBANT PAD
34857	Sterile adh. BWT dressing 8x6 cm - box of 50 pcs
34858	Sterile adh. BWT dressing 10x10 cm - box of 50 pcs
34859	Sterile adh. BWT dressing 10x15 cm - box of 50 pcs

SILK PLASTER ROLL

- **34787 SILK PLASTER ROLL 10 m x 2.5 cm - box of 12**
 - **34788 SILK PLASTER ROLL 10 m x 5 cm - box of 6**
- Silk surgical tape, white colour.

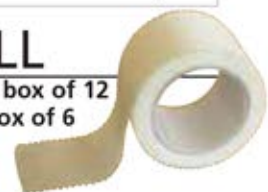

PLASTER ROLLS



Each roll is supplied with a plastic roll cover except code 34798

PLASTER ROLLS - MADE IN ITALY			
Skintone fabric	Hypoallergenic Non woven	Size	Minimum order
34803	34804	5 m x 2.5 cm	box of 12 rolls
-	34798	9.14 m x 2.5 cm	box of 12 rolls
34806	34807	5 m x 5 cm	box of 6 rolls
34799	Shop Display: for showing up to 88 boxes (32 x 25 xh 63 mm)		

NON WOVEN PAPER TAPE ROLL

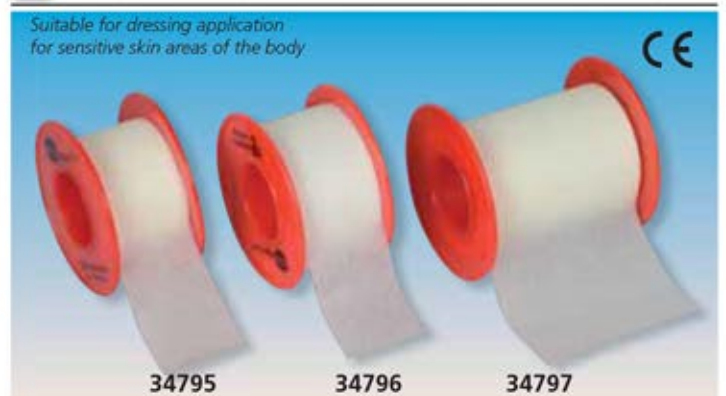

code	NON WOVEN PAPER TAPE ROLL HYPOALLERGENIC ADHESIVE	Minimum order
34795	Tape roll h 25 mm x 5 m	box of 12 pcs
34796	Tape roll h 25 mm x 9.14 m	box of 12 pcs
34797	Tape roll h 50 mm x 9.14 m	box of 6 pcs

3M TAPES: MICROPORE™, MEDIPORE™, DURAPORE™, TRANSPORE™



A latex-free, hypoallergenic paper tape that is gentle to the skin and doesn't leave adhesive upon removal. Highly breathable and economical. Can be used on wet skin.



code	3M code	3M MICROPORE™ PAPER TAPES	Minimum order
34904	1530-0	MICROPORE™ - h 12.5 mm x 9.14 m	box of 24 rolls
34905	1530-1	MICROPORE™ - h 25 mm x 9.14 m	box of 12 rolls
34906	1530-2	MICROPORE™ - h 51 mm x 9.14 m	box of 6 rolls
34907	1530-3	MICROPORE™ - h 76 mm x 9.14 m	box of 4 rolls



A silk tape with a latex-free, hypoallergenic adhesive that offers high strength and adhesion to skin.



code	3M code	3M DURAPORE™ SILK TAPES	Minimum order
34925	1538-1	DURAPORE™ - h 25 mm x 9.14 m	box of 12 rolls
34926	1538-2	DURAPORE™ - h 51 mm x 9.14 m	box of 6 rolls



Latex-free, hypoallergenic soft cloth tape. Gentle, breathable and easy-tear. Excellent cross and diagonal stretch to accommodate swelling and body movements. Available also with unique non-adherent pad.

code	3M code	3M MEDIPORE™ SOFT CLOTH TAPES and 3M MEDIPORE™ + PAD	Minimum order
34930	2991-1	MEDIPORE™ - h 50 mm x 10 m	box of 1 roll
34931	2991-2	MEDIPORE™ - h 100 mm x 10 m	box of 1 roll
34932	2991-3	MEDIPORE™ - h 150 mm x 10 m	box of 1 roll
34933	2991-4	MEDIPORE™ - h 200 mm x 10 m	box of 1 roll
34936	3562E	MEDIPORE™ + PAD - 5x7 cm	box of 25 pcs
34937	3566E	MEDIPORE™ + PAD - 10x10 cm	box of 25 pcs
34938	3569E	MEDIPORE™ + PAD - 10x15 cm	box of 25 pcs
34939	3570E	MEDIPORE™ + PAD - 10x20 cm	box of 25 pcs



Latex-free, hypoallergenic, transparent and perforated plastic tape that offers strong adhesion. Elastic and water-resistant.

code	3M code	3M TRANSPORE™ PLASTIC TAPES	Minimum order
34941	1527-1	TRANSPORE™ - h 25 mm x 9.14 m	box of 12 rolls
34942	1527-2	TRANSPORE™ - h 51 mm x 9.14 m	box of 6 rolls

BSN TAPES: LEUKOPOR®, LEUKOPLAST®, HYPAFIX®



The gentle tape for highly sensitive skin. For the fixation of dressings of all types and sizes. Non woven fabric and skin friendly adhesive mass.

code	BSN code	LEUKOPOR®	Minimum order
59501	02454-00	LEUKOPOR® 25 mm x 9.2 m	box of 12 rolls
59502	02455-00	LEUKOPOR® 50 mm x 9.2 m	box of 6 rolls



Highly adhesive tape for normal skin indicated when a strong adhesion is needed. Viscose fabric coated with a traditional adhesive mass (natural rubber).

code	BSN code	LEUKOPLAST®	Minimum order
59504	01532-00	LEUKOPLAST® 25 mm x 5 m	box of 12 rolls
59505	01534-00	LEUKOPLAST® 50 mm x 5 m	box of 6 rolls



Non woven dressing retention sheet for the retention of dressings especially on highly contoured and frequently moved parts of the body. Conformable non woven fabric coated with a polyacrylic adhesive mass



code	BSN code	HYPAFIX®	Minimum order
59510	71443-01	HYPAFIX® 50 mm x 10 m	box of 1
59511	71443-02	HYPAFIX® 100 mm x 10 m	box of 1
59512	71443-03	HYPAFIX® 150 mm x 10 m	box of 1
59513	71443-04	HYPAFIX® 200 mm x 10 m	box of 1

3M STERI-STRIP™ - SKIN CLOSURE STRIPS

Adhesive skin closures made of non-woven backing coated with a pressure-sensitive hypoallergenic adhesive. Sterile, breathable and comfortable to wear.



REINFORCED STERI-STRIP™
With polyester reinforcing filaments for higher tensile strength, reduced infection and scarring risk and better cosmetic outcomes.



34912



code	3M code	3M REINFORCED STERI-STRIP™ - sterile - skin closure	Minimum order
34909	R1540	STERI-STRIP™ - 3x75 mm	50 bags of 5 strips
34910	R1541	STERI-STRIP™ - 6x75 mm	50 bags of 3 strips
34908	R1542	STERI-STRIP™ - 6x38 mm	50 bags of 6 strips
34911	R1546	STERI-STRIP™ - 6x100 mm	50 bags of 10 strips
34913	R1549	STERI-STRIP™ - 12x50 mm	50 bags of 6 strips
34912	R1547	STERI-STRIP™ - 12x100 mm	50 bags of 6 strips
34914	R1548	STERI-STRIP™ - 25x125 mm	25 bags of 4 strips



ELASTIC STERI-STRIP™
Stretches with body movement or edema. Mostly suited for special applications (e.g. joints) or plastic surgery. Skin tone.

34990

code	3M code	3M ELASTIC STERI-STRIP™ - sterile	Minimum order
34987	E4540	STERI-STRIP™ - 3x75 mm	50 bags of 5 strips
34988	E4541	STERI-STRIP™ - 6x75 mm	50 bags of 3 strips
34989	E4542	STERI-STRIP™ - 6x38 mm	50 bags of 6 strips
34990	E4546	STERI-STRIP™ - 6x100 mm	50 bags of 10 strips
34991	E4549	STERI-STRIP™ - 12x50 mm	50 bags of 6 strips
34992	E4547	STERI-STRIP™ - 12x100 mm	50 bags of 6 strips
34993	E4548	STERI-STRIP™ - 25x125 mm	25 bags of 4 strips

SUTURE STRIPS

• **34997 STERILE SUTURE STRIPS** - box of 8
Sterile adhesive strips for cut and wound suture. Cut to measure. Dermatologically tested. It contains 5 small strips (3x75 mm) and 3 medium strips (6.4x80 mm). Multilanguage box: GB, FR, IT, ES, DE.



34997

SOOTHING PATCH

• **34830 PREVIDOL SOOTHING PATCH**
9x14 cm - pouch of 5
Previdol is a Medical Device patch adjuvant in the treatment of pains in the joints and the muscular-skeletal system. It acts on the affected part, keeping the skin protected and helping to give relief in presence of pain. To improve the cutaneous tolerability of the patch, some plant extracts like Arnica Montana, Devil's Claw and Boswellia were inserted, as well as some essential oils of Mint and Menthol to give a pleasant fragrance. Box: GB, IT.



3M SKIN CARE SOLUTIONS - CAVILON™

A complete range of barrier products to protect the skin from body fluids and friction. Cavilon™ products create on the skin a highly breathable, long lasting transparent coating to prevent maceration and trauma. Alcohol-free, hypoallergenic and non irritating, can be used on broken skin and under any tapes and dressing.

code	3M code	3M CAVILON™	Minimum order
34974	3346E	Cavilon™ no sting barrier film - spray 28 ml	box of 12
34973	3346P	Cavilon™ no sting barrier film - spray 28 ml	box of 1
34975	3392G	Cavilon™ durable barrier cream 92 g	1 dispenser
34976	9274	Cavilon™ continence care wipes	12 boxes of 8

3M CAVILON™ NO STING BARRIER FILM
Up to 72 hours of protection for peri-wound and peri-ostomy skin.



3M CAVILON™ DURABLE BARRIER CREAM
Zinc-oxide free barrier cream for continence care. Apply twice a day.

3M CAVILON™ CONTINENCE CARE WIPES
«All in 1» wipes for cleansing, moisturizing and protecting the skin.



ADHESIVE PLASTERS AND SPRAY



code	HYPOALLERGENIC ADHESIVE PLASTERS	Minimum order
34809	Water resistant - 19x72 mm	2,000 (100 boxes of 20)
34814	Water resistant - 4 mixed sizes	2,000 (100 boxes of 20)
34817	Sensitive skin - 5 mixed sizes	3,200 (80 boxes of 40)
34823	Spray plaster - bottle of 30 ml	box of 12

PLASTER DISPENSER



• **34826 PLASTER DISPENSER** - with 2 refills (one each type)
• **34827 REFILL 42 TEXTILE PLASTERS** 19x72 mm - box of 6
• **34828 REFILL 38 TEXTILE PLASTERS** 25x72 mm - box of 6
Dispenser for adhesive plasters ready for use. It allows operator to extract plaster with one hand and apply directly on the wound. Transparent cover protects plaster and shows residual quantities. Lockable and with fixing wall kit included.

3M TEGADERM™ DRESSINGS



TEGADERM™

Transparent, sterile waterproof dressing. Highly breathable. Frame style for easy application also available in non-sterile roll.



34895

TEGADERM™ + PAD

Transparent, sterile waterproof dressing. Highly breathable. Frame style for easy application. With a non-adherent absorbent PAD. Ideal for surgical wounds.



code	3M code	3M TEGADERM™ FILM	Minimum order
34900	1624W	TEGADERM™ - 6x7 cm - sterile	box of 100 pcs.
34901	1626W	TEGADERM™ - 10x12 cm - sterile	box of 50 pcs.
34902	1627	TEGADERM™ - 10x25 cm - sterile	box of 20 pcs.
34903	1628	TEGADERM™ - 15x20 cm - sterile	box of 10 pcs.
34899	16004	TEGADERM™ - 10 cmx10 m non sterile	1 roll

code	3M code	3M TEGADERM™ PAD	Minimum order
34895	3582	TEGADERM™ + PAD 5x7.2 cm - sterile	box of 50 pcs.
34896	3586	TEGADERM™ + PAD 9x10 cm - sterile	box of 25 pcs.
34897	3589	TEGADERM™ + PAD 9x15 cm - sterile	box of 25 pcs.
34898	3591	TEGADERM™ + PAD 9x25 cm - sterile	box of 25 pcs.

3M VASCULAR ACCESS SOLUTIONS - TEGADERM™ IV

A complete range of sterile, waterproof, highly-breathable transparent film dressings to protect IV sites from water, virus and bacteria. With antifriction backing and reinforced non-woven borders for longer wearing time and minimized catheter dislodgement risk.



TEGADERM™ IV

A cost-effective solution for peripheral and central vascular lines with strong hold and gentle removal.

code	3M code	3M TEGADERM™ IV - STERILE	Minimum order
34945	1633	7x8.5 cm - for peripheral lines	box of 100
34946	1635	8.5x10.5 cm - for central lines	box of 50



TEGADERM™ IV ADVANCED

A reinforced, 100% waterproof, advanced solution for better securement and longer wearing time.

code	3M code	3M TEGADERM™ IV ADVANCED - STERILE	Minimum order
34947	1683	6.5x7 cm for peripheral lines	box of 100
34948	1685	8.5x11.5 cm for central lines	box of 50

3M SOLUTIONS FOR CHRONIC WOUNDS



34968

34969

TEGADERM™ HYDROCOLLOID

Sterile hydrocolloid dressing for low to moderate draining wounds. Also available in sacral shape with highly breathable waterproof border.

code	3M code	3M TEGADERM™ HYDROCOLLOID	Minimum order
34968	90002	HYDROCOLLOID™ 10x10 cm square	box of 5
34969	90007	HYDROCOLLOID™ 16x17 cm sacral	box of 6



TEGADERM™ ALGINATE

High integrity, gel forming alginate dressing for moderate to heavily exuding wounds. Compact and comfortable.

TEGADERM™ ALGINATE AG

Antimicrobial, highly absorbent wound dressing with calcium alginate, carboxymethyl cellulose and ionic silver complex. To prevent and treat wound infections.

code	3M code	3M TEGADERM™ ALGINATE and ALGINATE AG	Minimum order
34964	90112	TEGADERM™ ALGINATE - 10x10 cm	box of 10
34965	90312	TEGADERM™ ALGINATE AG - 10x10 cm	box of 10



34954

34957

34955

TEGADERM™ HIGH PERFORMANCE FOAM

Sterile, multi-layer foam dressing that combines high absorbency with high breathability to reduce the risk of wound maceration. Well suited for changing levels of exudate to maintain moisture balance for optimal wound healing. Highly breathable and waterproof, also available in heel/elbow shape with adhesive border and simplified application system.

code	3M code	3M TEGADERM™ FOAM - non adhesive or adhesive dressing	Minimum order
34954	90601	TEGADERM™ FOAM - 10x10 cm	box of 10
34955	90604	TEGADERM™ FOAM - 9x9 cm for tracheostomy	box of 10
34957	90619	TEGADERM™ FOAM ADHESIVE for heel and elbow - 14x14 cm	box of 5



TEGADERM™ HYDROGEL

Preservative-free hydrogel wound filler, easy to apply. Formulated to help provide a moist wound healing environment. Single use tube.



34972

code	3M code	3M TEGADERM™ HYDROGEL	Minimum order
34972	91110	TEGADERM™ HYDROGEL 15 g	box of 10

BURNFREE® - BURN CARE PRODUCTS



A complete range of burn care products with superior benefits:

- dissipates heat on contact
- cools the burn site, relieves pain, calms the burn victim, helps stop the burn process
- covers the burn, helps to prevent contamination
- accommodates swelling or the need to flex joints thanks to elastic texture

Sterile burn and wounds dressings

Made of a soft open-cell, non-adherent, inert foam, saturated with Burnfree® gel, does not leave residues imbedded in the wound.

Pain relieving gel

Ideal for all minor burns (including sunburns), cuts and abrasions, available in bottle or single use dose 3.5 g. Without lidocaine, which makes it suitable for children.

code	BURNFREE® PRODUCTS
34869	Burn Dressing - 5x5 cm - box of 120 pcs
34870	Burn Dressing - 5x15 cm - box of 10 pcs
34871	Burn Dressing - 10x10 cm - box of 10 pcs
34872	Burn Dressing - 20x20 cm - box of 5 pcs
34873	Burn Dressing - 30x30 cm - box of 20 pcs
34875	Pain Relieving Gel - bottle 120 ml
34883	Pain Relieving Gel - 3.5 g sachets - box of 20 pcs
34882	Pain Relieving Gel - 3.5 g sachets - box of 1,000 pcs
34878	Burn Kit (2 sterile dressing 5x15 cm and 2 10x10 cm, 1 gel bottle 120 ml, 20 gel sachets 3.5g and 2 rollers gauzes)

HYPOTHERMIC BLANKET

• 34086 HYPOTHERMIC BLANKET

Reflects and retains over 80% of radiated body heat to keep a person warm and protected even at subzero temperature. Waterproof, reusable, wind proof, lightweight.



Made of polypropylene Fralom fibre coupled to a metallized polyethylene fibre.

Size 200x150 cm

Blanket colour may change in the time

BURNFREE® - FIRE BLANKET

Bags with strap for easy transport (34880-1 only)

34879

Supplied with bag



34880

BURNFREE FIRE/TRAUMA BLANKETS

Provides physical protection from heat, fire and smoke. Cools and soothes burn area. Fire resistant, are a protective shield for a person trapped by fire.

code	Blanket Size	Weight
34879	91x76 cm	2.3 kg
34880	183x152 cm	6.9 kg - 15 lbs
34881	244x152 cm	10.9 kg

ISOTHERMIC COVER

• 34085 EMERGENCY COVER

Suitable for protection against cold and heat. Silver side in keeps the warmth of the body, gold side out reflects sunbeams.



Size: 160x210 cm. Weight: 67 g

Radio transparent

FIRE RETARDANT BLANKET

• 34087 FIRE RETARDANT BLANKET

Made in glass fibre. Can be used to extinguish small fires. Size: 150x180 cm



34087

INSTANT ICE: SPRAY OR BAG IN TNT OR PE



- 34110 INSTANT ICE - TNT 14x18 cm bag (non woven fabric)
- 34111 INSTANT ICE - PE 14x18 cm bag (polyethylene) minimum order: pack of 25 bags.

Icy-pack "instant ice" is recommended for cryotherapy. Excellent in case of traumas to soothe the pain and to prevent haematomas, swellings, etc.

Easy and quick to use anywhere and anytime.

Press the bag to break the inner bubble and shake to mix contents. The blend you obtain drops temperature of the pack down. Activates at -6°C, reaches 0°C in 30 minutes (at environment temperature of 20 °C).

• 34112 SPRAY INSTANT ICE - bottle 400 ml

Ecological, useful for small bruises, haematomas or trauma, in first aid or sport applications. Spray on the injured area at 20 cm distance. (see the reference temperature chart). Content: Ammonium nitrate + water.

ANTIBACTERIAL HAND CLEANING GEL



ANTIBACTERIAL HAND CLEANING GEL

Antibacterial hand cleaning gel, cleans the hands and prevents the settlement of bacteria.

It is effective against bacteria, virus, fungi.

No need of water. Gima range includes 4 sizes and 4 different flavours (neutral transparent, apple, strawberry, lemon).

code	ANTIBACTERIAL HAND CLEANING GEL	minimum order
36580	Antibacterial gel 85 ml tube - transparent	box of 48
36581	Antibacterial gel 85 ml tube - green - apple	box of 48
36582	Antibacterial gel 85 ml tube - red - strawberry	box of 48
36583	Antibacterial gel 85 ml tube - yellow - lemon	box of 48
36590	Antibacterial gel 500 ml bottle* - transparent	box of 15
36591	Antibacterial gel 500 ml bottle* - yellow - lemon	box of 15
36595	Antibacterial gel 1 l bottle* - transparent	box of 12
36597	Antibacterial gel 5 l bag - transparent	box of 4
33283	Dispenser pump for 36597	1

*Each bottle includes dispenser pump

MULTIUSI GEL

- 36646 MULTIUSI GEL - 50 ml - box of 24 tubes
- 36647 MULTIUSI GEL - 75 ml - box of 24 tubes
- 36645 MULTIUSI GEL - 65 ml - spray - box of 36 pcs.
- 36642 MULTIUSI GEL - 150 ml - box of 24 pcs.
- 36644 MULTIUSI GEL - 1000 ml*
- 36692 DISPENSER PUMP - for 36644

Cleanser hygienic for hands without water. Ready-to-use product, which contains 62% ethyl alcohol for a rapid and effective hands disinfection. It has been studied to sanitize and clean hands without using water. It dries fast and leaves hands soft and fresh. Its disinfecting power is combined with an effective skin-protecting action, it guarantees hygienic protection in few seconds. Made in Italy.

36644



*Sold in box of 12 pcs, only 2 pieces come with dispenser pump

SURGERY DISINFECTANT

- 36632 NEO STERIXIDINA SOAP - 1 l
- 36690 DISPENSER PUMP

Recommended for preparation of hands before surgical intervention and for complete washing of patients. Direct action towards bacteria Gram⁺, Gram⁻.

Made in Italy.

4% CHLORHEXIDINE

CHEMICAL COMPOSITION

100 g contains: Chlorhexidine digluconate 4 g - Isopropyl alcohol 4 g - Coformulants - Depurated water as needed for 100g

Italian Health Ministry registration 18980



MEDICAL SOAP

- 36629 MEDICAL SOAP - 0.5 l - box of 12
- 36630 MEDICAL SOAP - 1 l
- 36690 DISPENSER PUMP

Antiseptic liquid for disinfection of skin and hands. It is studied for people who need frequent washing as surgeons, medical and hospital attendants also before surgical operations.

2 dispenser pump every 12 bottles

Instruction: GB, IT.

Made in Italy.

Italian Health Ministry registration 19570



36629

36630

BARRIER CREAM - HANDS PROTECTION

- 36578 BARRIER CREAM - 500 ml

White barrier cream, enriched with vitamins and ingredients which protect the skin from everyday risks.

It acts as an **invisible barrier** that allows regular perspiration and prevents from irritation, pricking, redness, cracking and from contact with liquids such as detergents, greases and oils. Waterproof: its film barrier resists even after several washing with water.

Can be used many times during the day.

The cream is also ideal to avoid skin's maceration due to the use of gloves.

For professional use.

Made in Italy.

36578



DENTAL PROTECTION

- 36650 GERMOXID MOUTHWASH - 1 l with chlorhexidine

Specifically formulated to guarantee the highest hygienic standards and oral cavity disinfection.

Chlorhexidine is the most widely used and effective germicidal agent and acts against Gram⁺ and Gram⁻ bacteria, giving an overall anti-plaque and anti-gingivitis action.

Germoxid with its anti-plaque action guarantees efficient and long-lasting protection up to 12 hours.

Its alcohol-free formula assures that neither gum irritation nor a burning sensation will be felt.

It contains Aloe Vera in its formula: this is a particularly suitable extract for oral hygiene with high cicatrizing power.

Made in Italy.

36650



NOVALCOL SKIN DISINFECTANT

- 36609 NOVALCOL - 250 ml - box of 12 bottles
- 36611 NOVALCOL - 1 l
- 36613 NOVALCOL - 3 l

Novalcol must be used pure before and after the injection, or in the preoperative cleaning of the patient (or for those confined to bed). Novalcol is non irritant and non inflammable. It does not stain or burn. Efficient against gram⁺, gram⁻. Instructions on the bottle in GB, IT.

CHEMICAL COMPOSITION	
Benzalkonium Chloride	0.1 g
O-phenilphenol	0.02 g
Isopropyl Alcohol, Coformulants, depurated water as needed to	100 g
Made in Italy.	

Italian Health Ministry
Registration 13428

36611

36609

36613



FLOW PACK WIPES

- 36627 FLOW PACK 20 WIPES

Disinfectant detergent perfumed wipes for hands and body disinfection. Active against bacteria to guarantee hygiene and total protection. Suitable to fight against effects of perspiration, eliminating bacteria that cause bad smells. Good for children and in case of insects bites. Ready to use, they do not stain and do not grease.

Minimum order: 1 display of 16 flow pack with 20 wipes

Italian Health Ministry. Registration 12671

36627

FAZZOLETTI
DISINFETTANTI

Per una rapida
disinfezione
e un'igiene sicura



SALVIETTE DISINFETTANTI
DETERGENTI PROFUMATE

Eliminano
Germi e Batteri

Presidio
Medico Chirurgico

GERMOL

MULTIUSI FAZZOLETTI

DISINFETTANTE

DETERGENTE

PROFUMATE

FAZZOLETTI

DISINFETTANTI

DETERGENTI

PROFUMATE

FAZZOLETTI

DISINFETTANTI

DETERGENTI

PROFUMATE

FAZZOLETTI

DISINFETTANTI

DETERGENTI

PROFUMATE

FAZZOLETTI

DISINFETTANTI

DETERGENTI

PROFUMATE

FAZZOLETTI

DISINFETTANTI

DETERGENTI

PROFUMATE

FAZZOLETTI

DISINFECTANT WIPES

DISINFECTANT WIPES

- 36625 tube of 100 wipes
- 36626 box of 400 bags

Active against bacteria are ideal for children since they do not burn. Indispensable in the house, the car, in sporting events.

Indicated for the disinfection of:
- insect bites
- skin before and after injections
- disinfection of hands and other body parts.

Instructions on the box in GB, IT.

Italian Health Ministry
Registration 12671

36626

36625



HYDROGEN PEROXIDE

- 36604 OXYGENATED WATER (Hydrogen peroxide) - 250 ml - box of 12
 - 36606 OXYGENATED WATER (Hydrogen peroxide) - 1 l
- Hydrogen peroxide (3% diluted solution) 10 volumes. Colourless, odourless. 100% biodegradable. Made in Italy.

36606

36604



CHEMICAL COMPOSITION

100 g contain: Benzalkonium Chloride 0.5% - O-phenilphenol 0.01% - Coformulants and water as needed to 100 g. Made in Italy.

ALCOHOL SWABS/PADS

- 36601 QUICKPAD DISPENSER

Fleece pads saturated with 70% Isopropyl Alcohol. The tight fitting lid prevents evaporations. Size 50x50x80 mm contains 150 pads, size: 44x44 mm.

U.S. and International Patents FDA Reg. #8010920

150 ALCOHOL SWABS



ALCOHOL SWABS/PADS

- 36598 ALCOMED PADS - box of 100
 - 36599 ALCOMED PADS - carton of 10,000 (100 boxes of 100 pads)
- Alcohol saturated pads with 70% isopropyl alcohol for skin preparation prior to injection. Bag size 50x50 mm, folded pad 32.5x30 mm, open pad 65x30 mm.

36598



NaCl 0.9% B-BRAUN STERILE IRRIGATION SOLUTIONS

B-BRAUN
SHARING EXPERTISE



code	B-BRAUN code	B-BRAUN	Minimum order
36550	3570310	B-BRAUN ECOLAV® - 30 ml	box of 100
36551	3570350	B-BRAUN ECOLAV® - 100 ml	box of 20
36552	3570380	B-BRAUN ECOLAV® - 250 ml	box of 20
36554	3570110	B-BRAUN ECOTAINER® - 250 ml	box of 12
36555	3570130	B-BRAUN ECOTAINER® - 500 ml	box of 10
36558	3513576	B-BRAUN OMNIFLUSH® - 10 ml	box of 100

ECOLAV®

The spray nozzle of Ecolav® allows a precise and direct irrigation of the target area by simply applying a slight pressure on the container, helping optimize the time for irrigation processes. Multilanguage manual and box: GB, FR, IT, ES, DE, PT, NL.

ECOTAINER®

Ecotainer® non-drip pouring characteristics help reduce contamination risks during the irrigation process. Suggested for quick irrigation with high volume of solution. Multilanguage manual and label: GB, FR, IT, ES, DE, PT, NL, DK, FI, NO, SE.

B-BRAUN OMNIFLUSH®

PREFILLED FLUSH syringe 10 ml with NaCl 0.9% - box of 100 - EM-3513576
The Omniflush® syringe is designed specifically to minimize unintended blood reflux into the catheter lumen thus reduces the risk of catheter blockage. With Omniflush® the fluid amount used for flushing can be reduced to the required minimum. For flushing of all intravenous accesses. Multilanguage manual and label: GB, FR, IT, ES, DE, PT, PL, CZ, BG, DK, EE, FI, GR, HU, LT, LV, NL, NO, RO, SK, SI, SE.



36558

36558

CE 0123

SURGICAL SCRUB BRUSHES/SPONGES



- **36570 SCRUB KIT - sterile - dispenser of 30 pcs**
Sterile hand-cleaning hospital kit. It includes a scrub, a sponge and a plastic nail cleaner. Dry, without detergent. Sterilization method: ETO. Multilanguage label (blister and dispenser): GB, FR, IT, ES, DE, PT, PL, NL, GR, RU, Arab. Made in Italy.

All scrub kits are individually blistered in 30 pieces dispenser



36570



- **36571 IODO-POVIDONE SCRUB KIT dispenser of 30 pcs - IT**
Italian Health Ministry registration PMC 19575
- **36572 IODO-POVIDONE SCRUB KIT dispenser of 30 pcs - Multilanguage***
**Label: GB, FR, ES, DE, PT, PL, NL, GR (blister and dispenser), PL, RU, Arab (blister only)*
Same as 36570 with solution of PVP Iodine 7.5 g in 100 ml. Made in Italy.



36571



36572



- **36573 CHLOREXIDINA SCRUB KIT dispenser of 30 pcs - IT**
Italian Health Ministry registration PMC 19531
- **36574 CHLOREXIDINA SCRUB KIT dispenser of 30 pcs - Multilanguage***
**Label: GB, FR, ES, DE, PT, NL, GR (blister and dispenser), PL, RU, Arab (blister only)*
Same as 36570 with solution of Chlorhexidine Gluconate 20% 4 g in 100 ml. Made in Italy.



36573



36574

PERFECTION BRUSHES



STERILIZABLE IN AUTOCLAVE

- **25715 PERFECTION BRUSHES**
Nylon brushes for cleaning before and after operation. These brushes are autoclavable (at 100°C for not more than 5 minutes) and can be stored in any standard brush dispenser in hospitals. Resistant and reliable. Handle in PP. Supplied in boxes of 12 units.

IODO-POVIDONE ANTISEPTIC

- **36614 IODO-POVIDONE ANTISEPTIC 125 ml**
- **36608 IODO-POVIDONE ANTISEPTIC 500 ml**
- **36619 IODO-POVIDONE ANTISEPTIC 1,000 ml**

Wide spectrum disinfectant for the disinfection and cleaning of the skin in hospital wards with high risk of infection. Medical-Surgical Presidium n.19661. The range of action includes Gram⁺ and Gram⁻ germs, acid and acid resistant bacteria and virus. Its activity is maintained in the presence of organic materials. Label: GB, IT. Made in Italy.

IODO-POVIDONE
10% IODINE

CHEMICAL COMPOSITION

Each 100 ml contains: polyvinylpyrrolidone iodine 10 g, coformulants and purified water needed to 100 ml



36614

36608

36619

CHLORHEXIDINE DISINFECTION LINE



- **36637 GERMOXID SPRAY DISINFECTION - 100 ml - box of 12**
- **36635 GERMOXID DISINFECTION - 250 ml - box of 12**
- **36636 GERMOXID DISINFECTION - 1,000 ml - box of 12**
- **36634 GERMOXID WIPE - 12 boxes of 10 wipes**
- **36638 GERMOXID WIPE - box of 400 wipes**

Germoxid is a ready-to-use disinfectant for skin that contains Chlorhexidine with long-lasting bactericidal action. Chlorhexidine has a proven broad-spectrum effectiveness against Gram⁺ and Gram⁻ bacteria. The molecular structure of Chlorhexidine is very similar to that one of epidermis proteins and it is therefore rapidly and constantly absorbed by the skin. Chlorhexidine is particularly suitable for skin disinfection. It is particularly safe for medical operators thanks to its high epidermis compatibility, it neither irritates the skin nor stains or burns. Available in 3 versions: liquid (250 or 1,000 ml), spray (spray dispenser allows a quick and efficient action and is eco-friendly) or wipes (ready-to-use disinfecting wet wipes containing chlorhexidine). Italian Health Ministry registration 11571



Label in
GB, IT

36636

36635

36637

BARRYCIDAL "30 PLUS": A WIDE-SPECTRUM DISINFECTANT



CE 0426

Manual in:
GB, IT, FR, ES.

- 35761 BARRYCIDAL "30 PLUS" - diluted 5% - bottle 1 l
- 35759 BARRYCIDAL "30 PLUS" - diluted 5% - bottle 1.2 l

minimum order: box of 12 bottles
minimum order: box of 6 bottles

Ready for use 1 or 1.2 l bottle with 10 cc measurer cap.

- 35763 BARRYCIDAL "30 PLUS" - concentrate, to be diluted - tube 224 ml
- 35764 BARRYCIDAL "30 PLUS" - concentrate, to be diluted - tank 3.785 l (1 Gallon)

Barrycidal 30 Plus is a water-based solution with glutaraldehyde and phenols, suitable to cleanse and disinfect surgical instruments and thermosensitive, non-autoclavable endoscopes, with good property to dissolve blood and organic traces. Colourless liquid emulsion. The product diluted by 5% is not classified as hazardous pursuant to the provisions set in Regulation 1272/2008 (CLP). Medical Device according to Class IIb - Directive 93/42 EEC.

Tested action-spectrum in "clean" conditions: bactericide (EN 13727 and EN 14561), fungicide (Candida Albicans, Aspergillus Niger; EN 13624 and EN 14562), mycobactericidal and tuberculocidal (Mycobacterium Avium, Mycobacterium Terraе; EN 14348 and EN 14563), virucidal (EN 14476).

30 Plus concentrate acts in 15 min. if diluted by 5%, 60 min. if diluted by 2.5%. Diluted by 2.5% results in 9 l of ready to use product.

CHEMICAL COMPOSITION

30 Plus concentrate: 100 ml contain: glutaraldehyde (<2%), 2-benzil-4-chlorophenol 4.5%, 2-phenylphenol 7%, coformulants and purified water.

30 Plus standard: contains less than 0.2% at 5% dilution glutaraldehyde, phenols, surfactants.



DISINFECTANT POWDER

- 36639 GERMOCID PERACETIC POWDER - bag 16 g - box of 50 bags
- 36640 GERMOCID PERACETIC POWDER - box of 500 g

CE 0546

Cold sterilizer disinfectant: the peracetic acid which forms from the reaction of sodium percarbonate and tetracetylendiammine (which is obtained after dissolving the product into water) carries on an efficacious biocidal action against spores, virus (HIV, HBV, HCV), bacteria, mycobacteria and fungi. At the concentration of 0.3% it carries on sterilization in 10 minutes.

The product is active in 15 minutes from dissolution, solution remains active for max 24 hours. Suitable for a cold rapid sterilization and disinfection of endoscopes, surgical and dental instruments, transducer, etc.

The product is active also in presence of organic materials.

In this case it is better to previously clean the device with suitable detergent, better if with enzymatic base.

It can also be used with automatic washing machines for endoscopes. No environmental impact: once in contact with discharge water, it degrades immediately into acetic acid, water, oxygen.

Chemical composition:

peracetic acid precursors and coformulants.

Made in Italy.



36640

SPRAY DISINFECTANT

- 36620 GERMOCID SPRAY DISINFECTANT - 400 ml

minimum order: 12 pcs

Spray disinfectant with bactericidal power. Disinfects and deodorizes surfaces and objects of crowded and smoky areas (hospitals, classrooms, examination and surgery rooms, bathrooms, cars, trailers). Instructions on box in GB, IT.

CHEMICAL COMPOSITION

100 g contain: O-phenilphenol 0.02 g; benzalkonium chloride 0.1 g. Coformulants and propellants as needed to 100 g. Made in Italy.

Italian Health Ministry registration 7604



36620

BOXES FOR COLD STERILIZATION



35770

- 35770 STERILIZATION BOX - 1.5 l (internal: 10x25.5xh 7.5 cm)

Useful plastic box, with an internal removable perforated instrument tray, specially developed for cold sterilization of medical instruments. White colour. Made in Italy.



35772 autoclavable

- 35772 STERILIZATION BOX - 3 l (internal 18.3x29xh 9 cm) - autoclavable

GERMOCID TABS

- 36622 GERMOCID TABS CHLORINE TABLETS - 1 kg

White round effervescent chlorine tablets for cleaning, disinfecting and deodorizing. The dilution of 1 tablet in 7-8 litres of water or 2 tablets if you need stronger disinfection allows to hygienize rubber, plastic or glass. Germocid tabs can be used for many other purposes:

wc sanitizing, dishwasher, floor cleaning and also for mopping bars, restaurants, hospitals.

Rinsing required. Packed in 1 kg jar, containing approx: 300 tabs.

Label/instruction in GB, IT.

Made in Italy.



36622

ENZYME-BASED DETERGENT

- 36618 ENZYME-BASED DETERGENT - 3 l

Medical device enzymatic based detergent for invasive surgical instruments. This clear liquid detergent is very useful to improve the cleaning of orthodontic and surgical instruments, glassware, plastic and metal objects. Also suitable for ultrasound cleaners. Dilute in 1 litre warm water, immerse the instruments for 10 minutes and rinse. Label/instruction in GB, IT.

Made in Italy.

CE 0546



36618

CHEMICAL COMPOSITION

100 g contain: proteolytic enzymes 0.5 g, non-ionic surfactant agents 10-15 g, coformulants, water as needed to 100 g

MULTILAYER DECONTAMINATING MAT WITH ANTIBACTERIAL



DAILY WAY TO KEEP
POLLUTION AWAY

- 36685 DECONTAMINATING MAT 45x90 - box of 5 - blue
- 36686 DECONTAMINATING MAT 60x90 - box of 5 - blue

DECONTAMINATING MATS

Mats to be used in all environments that require total absence of contaminating agents and the preservation of high hygienic levels. GIMA mat, thanks to antibacterial glue captures and retains dust and bacteria and substantially reduces bacteria growth and spreading. A full length adhesive sheet on the bottom of the mat provides a firm grip to the floor. Easy removability without leaving any adhesive trace.

Each mat includes 30 numbered polythene sheets and a non-adhesive edge strip to allow easy removal of each used layer. Medical disposable device CE Classe 1 non-sterile. Packed in a stylish dispenser folder with handle for easy carriage and vertical storage. Each mat can be easily picked leaving the others perfectly stored. Total mat thickness: 1.5 mm. Box of 5 mats with 30 sheet each. On request (minimum 10 boxes) available in white or green and size 60x95 cm or 90x95 cm.

- 36693 DECONTAMINATING MAT 45x115 - box of 5 - blue
- 36694 DECONTAMINATING MAT 60x115 - box of 5 - blue
- 36695 DECONTAMINATING MAT 90x115 - box of 5 - blue
- 36696 DECONTAMINATING MAT 45x115 - box of 5 - white

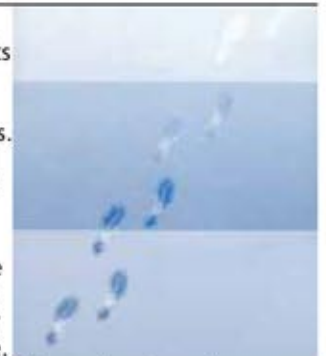

GERMOCID WIPES FOR SURFACES, MEDICAL DEVICES

- 36680 GERMOCID WIPES - 120 wipes - tube

Ready to use wipe, it contains a Chlorhexidine and Quaternary Ammonium Salt based alcoholic solution. With a fast and effective disinfectant action against Bacteria Gram⁺ Gram⁻ Yeasts, Moulds, Fungi, Tuberculous Mycobacteria (TBC). Lipophilic and hydrophilic Viruses (HIV - HVB - HVC).

The product has a high detergent power and it quickly evaporates.

It is not inactivated by organic residuals.

Suitable for cleaning and disinfection of non-invasive medical devices and surfaces disinfection in medical and dental medical offices.

Wipe size: 200x240 mm.

CE 0546



36680

GERMOCID BASIC SPRAY

CHEMICAL COMPOSITION

100g of product contain	
Chlorhexidine digluconate	0.1 g
Benzalkonium chloride	0.1 g
Ethanol	45 g
2-Propanol	15 g
Coformulants	
and deperated water as needed for	100 g
Appearance: green liquid	
Smell: characteristic pine	

CE 0546

- 36615 GERMOCID BASIC - 750 ml
- For disinfection and fast cleaning of every kind of medical surface materials which are not sensitive to alcohol like arms, handles and different dentistry objects.

- **Disinfectant action:** the association between Chlorhexidine and Quaternary ammonium Salt and the high alcoholic content guarantee a large action spectrum towards:

- Bacteria gram⁺ and gram⁻; fungi and virus HIV, HBC, HCV (HEPATITIS B and C) in 1 minute of contact.

- Fungi, microbacteria and TBC in 5 minutes of contact.

Strong detergent power and fast evaporation.

It is not de-activated by organic substances.

- **Bactericide, virucide and fungicide activity.**

Sold in box of 12 - only 2 bottles come with vaporizer.

- 36691 VAPORIZER



36615

ENVIRONMENT DISINFECTANT

- 36616 ENVIRONMENT DISINFECTANT - bottle of 1 litre
- 36617 ENVIRONMENT DISINFECTANT - tank of 3 litres

Concentrated liquid detergent-disinfectant for environments. Dilute it in water to a ratio of 0.5% for the disinfection and the cleaning of surfaces, counter, tiles, floors, sanitary fixtures, also using floor-washing machines.

Suitable in large areas (hospitals, clinics, rest homes, gyms, swimming pools) for the disinfection and cleaning of surfaces.

- **Disinfectant action:** guarantees a wide protection against virus, fungi, bacteria Gram⁺ and Gram⁻.

- **Detergent action:** contains non-ionic surface active agents to enhance the cleaning of surfaces.



36617

36616

CHEMICAL COMPOSITION

100 g of product contain:	
Quaternary ammonium compound	10 g
Isotiazolinone magnesium chloride	0.2 g
Coformulants and deperated water	100 g
Appearance: pale yellow liquid	
Smell: citrus flavour	
Biodegradability: detergent according to rules CE n° 648/2004	
Italian Health Ministry authorization N° 9658	

BRANSON ULTRASONIC CLEANERS

Precision cleaning power

Ultrasonic cleaning is faster and safer than any other method. It's powerful enough to remove heavy oils and waxes, penetrating enough to deflux circuit boards, yet gentle enough to clean tiny precision assemblies.

Ultrasonic sound waves moving through a cleaning solution create an effect called cavitation, the rapid formation and implosion of microscopic bubbles. Heat enhances the process. The deep-cleaning action of ultrasonics removes even the most stubborn dirt and contaminations.

Branson: pioneer in ultrasonic cleaning

We have selected Branson because their cleaners incorporate years of experience in ultrasonic cleaning:

- easy to handle and safe to fill
- frequency higher than average for a deep cleaning
- less noise - longer lifetime.

All Branson cleaners are supplied with tank cover, and multi-language manual (GB, FR, IT, ES, DE, PT, SE, NL, RU). Recommended use with optional perforated tray.

M Series: M (Mechanical timer) or MH (Mechanical timer with heater)

Includes 60-minute mechanical timer and continuous operation with heating capability (MH only).

CPXH Series (Digital control with heater)

Are the most technologically advanced ultrasonic cleaners available. With programmable features, digital operation with power tracking capabilities to adjust for light or heavy loads, high/low power control and degassing. The CPXH is the most versatile system available.

CPX series is completely programmable, so engineers can choose temperature, start, and stop times for "set-it-and-forget-it" operation

Degassing periods of up to 99 minutes also allow for various sample prep applications.

Digital timer allows for continuous ultrasonic operation up to 99 minutes

Temperature can be set for either Fahrenheit or Celsius up to 69 °C/156.2 °F

Ultrasonic power tracking maintains steady, consistent activity in the bath when condition change



Feature	M Series Mechanical 60 minutes	MH Series Mechanical 60 minutes	CPXH Series Digital 60 minutes
Timer	•	•	•
Cover	•	•	•
Continuous mode	•	•	•
Sweep frequency	•	•	•
Heater	•	•	•
Dual power	•	•	•
Power tracking	•	•	•
Degas wave modulation	•	•	•
°C or °F temp selection	•	•	•
Auto ultrasonic activation	•	•	•
High-temp alarm	•	•	•
Front panel auto temp calibration	•	•	•
Operating parameters stored and saved	•	•	•

High/low power control provides safer cleaning of delicate components. 100% power for normal or 70% for delicate applications

TECHNICAL SPECIFICATIONS

	Branson 2800	Branson 3800	Branson 5800	Branson 8800
Tank size: mm	230x140x100	290x150x150	290x240x150	495x290x150
Overall size: mm	337x304x302	397x317x377	397x401x378	596x466x391
Tank capacity: litres (gal)	2.8 (0.75)	5.7 (1.5)	9.5 (2.5)	20.8 (5.5)
Drain and valve kit	No	Included	Included	Included
Weight: kg (lbs)	4.1 (9)	5.4 (12)	6.4 (14)	11.8 (26)
Frequency	40 KHz	40 KHz	40 KHz	40 KHz
Power supply	230-240 V	230-240 V	230-240 V	230-240 V

4 SIZES: 2.8, 5.7, 9.5, 20.8 LITRES.

3 MODELS: MECHANICAL, MECHANICAL + HEATER, DIGITAL + HEATER



ULTRASONIC CLEANERS	BRANSON 2800 2.8 litres	BRANSON 3800 5.7 litres	BRANSON 5800 9.5 litres	BRANSON 8800 20.8 litres
M Mechanical timer	35501	35510	35520	35531
MH Mechanical timer with heater	35502	35511	35521	35532
CPXH Digital timer with heater	35503	35512	35522	35533
ACCESSORIES				
Tank cover, plastic* or stainless steel**	35507*	35517*	35527*	35537**
Perforated tray	35508	35518	35528	35538
Tray	35505	35515	35525	35535
Beaker positioning cover	35506 2x 250 ml	35516 3x 250 ml	-	-
Beaker positioning cover 600 ml	35509 2x 600ml	35519 2x 600ml	35529 4x 600ml	35539 6x 600ml
Glass beaker 250 ml	35540	35540	-	-
Glass beaker 600 ml	35541	35541	35541	35541



FREE AND BASIC ULTRASONIC CLEANERS



ULTRASONIC CLEANERS

The ultrasonic tub is designed to wash instruments used in the medical, dental, cosmetic, veterinary fields. The ultrasound cleaning (cavitation) allows to thoroughly clean instruments difficult to clean manually.

Heating - FREE only

The device heats the detergent and stops automatically when the preset temperature is reached.

Degassing (degas) - FREE and BASIC

This process reduces the gas dissolved in the liquid, thus improving the efficiency of the subsequent washing.

Ultrasonic cleaning - FREE and BASIC

Washing phase through ultrasonic cavitation.

Sweep - FREE and BASIC

Ultrasounds are modulated in frequency, thus reducing the negative effects of stationary waves, increasing the distribution of ultrasonic energy within the washing liquid.

Discharge - FREE only

Tub of Basic has to be manually emptied, tub of Free can be emptied by opening the appropriate valve.

All ultrasonic cleaners are supplied with basket and lid.

ULTRASONIC CLEANERS	BASIC	FREE	BASIC	FREE
	3 l	3 l	9 l	9 l
Tank size mm	235x100x135		332x120x227	
Overall size mm	305x248x168	305x248x178	418x268x259	418x268x269
Weight kg	3.7	4	7.1	7.4
Ultrasonic power W	150	150	300	300

code	FREE AND BASIC ULTRASONIC CLEANERS
35550	Basic ultrasonic cleaner 3 l
35551	Free ultrasonic cleaner 3 l - with heating and discharge
35552	Basic ultrasonic cleaner 9 l
35553	Free ultrasonic cleaner 9 l - with heating and discharge

ULTRASONIC CLEANER



• 35549 GIMA 50 ULTRASONIC CLEANER 0.6 l

This ultra-compact cleaner is very easy to use, efficient and economic. Ideal to clean small objects. Electronic, non adjustable timer with plastic cover and basket. No heating. Internal size: 168x89x55 mm.

Supersonic wave 46,000 cycles per second.

GENERAL PURPOSE CLEANER

• 35544 BRANSON GENERAL PURPOSE

CLEANER - bottle 1 l concentrate

BRANSON PURPOSE is a cleaning solution developed for use with ultrasonic cleaners. Removes general soils, fingerprints, dust, light oils and greases.

Branson cleaning liquid has been specially developed to provide optimal transfer of acoustic energy.

Mainly used in: dentistry, medical and optical applications, laboratory, electronics, gold and silver works.



CHEMICAL SPECIFICATIONS

Concentration: 10-12%
Biodegradability: yes
Phosphate free
Concentration PH: 13.5
Rinsability: good

GIMA QUICK: STERILIZATION IN 2 MINUTES

• 35640 GIMA QUICK - hot bead sterilizer

• 35642 GIMA QUICK PLUS with thermometer

GIMA QUICK hot bead sterilizer has been designed and developed specifically for medical use. Also recommended for dentistry, podology, veterinary, tattoo and beauty studios. It ensures a quick and effective sterilization.

It sterilizes files and mirrors in 2 minutes, surgical instruments in 2 minutes, curettes and forceps in 3 minutes.

Its constant temperature over 230°C ensures the total destruction of micro-organisms and spores in few seconds.

GIMA QUICK has epoxydic powders painted steel casing; the inside cylinder is completely isolated by fibres and glass, which prevents heat from being transmitted to the external casing.

It can work continuously for the whole day.

Supplied with a pack of glass beads (220 g).

Made in Italy.

• 35645 PYREX BASIN

• 35646 PACK OF GLASS BEADS



TECHNICAL SPECIFICATIONS	
Outer structure in white painted steel	Weight: 2.8 kg
Size: 130x130x190 mm	Power consumption: 150 W
Copper plated basket: diameter 5.5 cm depth 7.5 cm	Operating voltage: 220 V - 50 Hz.
	Warranty: 12 months
	Made in Italy

DIGITAL OR THERMOVENTILATED DRY HEAT STERILIZERS



35584

Outer case and front completely made of stainless steel, included the drummed door strongly insulated with non-conducting material

TITANOX dry heat sterilizers 20, 60, 120 litres. Inner structure and height adjustable inner shelves completely made of stainless steel. Door with lock and key.

Thermovenilated unit: to guarantee the uniformity of the temperature in the heating room and to allow the circulation of the air, the device is provided with a ventilation motor that results always in operation, both during the cycle of heating and during the pauses of cooling.

Digital unit: adjustable aeration tunnels, placed on the bottom of the right side and on the top of the left side for hot air adjustment and circulation, which is useful for a quick cooling of the device.

code	GIMA code	Capacity	Outside dimensions (mm)	Inside dimensions (mm)
35583	35586	20 l	570x345xh 400	405x255xh 210
35584	35587	60 l	705x450xh 475	535x320xh 345
35585	35588	120 l	835x565xh 555	670x420xh 415



35586

Outer case made of steel, hinged door completely made of stainless steel

Supplied with manual in: GB, FR, IT, (ES on request) and 2 height adjustable trays. Made in Italy.

TECHNICAL SPECIFICATIONS

Thermovenilated:

Timer 0-120 minutes that switches off the oven at the end of the planned time
 Probe thermometer from 0° to 200°
 Probe thermoregulator from 0° to 200°
 Safety thermostat
 Ventilator for forced ventilation
 Double check up light bulb

Digital:

Electronic running C.P.S.
 Use modality: continuous (stand by) or timed
 Timer from 0 to 250 minutes
 Optimum heat distribution
 Automatic indication for possible problems of feeding (in case of mains tension lack, the program will start again from the beginning)

Operating voltage: 230 V - 50/60 Hz (110 V on request with surcharge for 35583-5)



35586

TAU STERIL AUTOMATIC DRY HEAT STERILIZERS 1.6, 6, 18 LITRES



35600



35606



35606



Front door, side and back in epoxy powder painted

35619

- 35600 TAU STERIL 1.6 - automatic hot air sterilizer
- 35606 TAU STERIL 6 - automatic hot air sterilizer
- 35619 TAU STERIL 18 - automatic hot air sterilizer

TAU sterilizers have been designed to satisfy all daily medical requirements in the field of sterilization.

Extremely robust, totally automatic, guarantee complete working safety.

TAU 1.6 and 6 have double wall and inner insulation, outside is made of stove-enamelled sheet steel, inside of stainless steel 18/8 (double cover, sterilization chamber and removable perforated tray).

TAU 18 comes complete with safety fuses, neon warning lights to control timer and thermostat, power cable, 3 itallumac treated shelves (375x200 mm), shelf extracting tongs.

TECHNICAL SPECIFICATIONS

	TAU 1.6	TAU 6	TAU 18
Inside dimensions (mm):	245x115xh 55	385x170xh 90	375x230xh 200
Outside dimensions (mm):	310x180xh 180	495x310xh 220	440x310xh 380
Weight:	5 kg	10.5 kg	14 kg
Operating voltage:	220 V	220 V	220 V
	110V available on request		
Power consumption:	250 W	400 W	600 W
Fuses:			3.15 A
Thermostat:	Automatic capillary bulb type with self registration from 90° to 200°		
Timer:	from 0 to 120 minutes		
Thermometer:	high precision with capillary bulb		
Made in Italy			

HOT AIR STERILIZERS: GIMETTE 1.5, 7, 21, 28 AND 50 LITRES



GIMETTE 1,5

35601

- 35601 GIMETTE 1.5 - hot air sterilizer
- 35607 GIMETTE 7 - hot air sterilizer



Automatic Gimette are compact and high quality hot air sterilizers with the same reliability and efficiency as larger models. Outside structure is made of painted plate with anti-scratch epoxy powder. Stainless steel lid and sterilization chamber with approx. Capacity of 1.5 l and 7 l. Removable, perforated for air circulation, tray with pliers. All components certified by most important European brands, assembling in compliance with EN-61010. A second safety thermostat triggers in case temperature should exceed 220°C. Red LED indicates any anomaly in thermoregulation and consequent starting of safety thermostat.

- 35631 RESISTOR 250 W for 35601 - spare
- 35632 RESISTOR 400 W for 35607 - spare
- 35612 GASKET for 35607 - spare
- 35613 GASKET for 35601 - spare



GIMETTE 7

35607

TECHNICAL SPECIFICATIONS

GIMETTE 1.5

Inside dimensions: 245x120x50 mm = vol. 1.5 dm³
 Outside dimensions: 310x180x180 mm
 Weight: 4.3 kg
 Power consumption: 250 Watt
 Fuse: 1 A

GIMETTE 7

Inside dimensions: 410x180x90 mm = vol. 7 dm³
 Outside dimensions: 490x310x180 mm
 Weight: 8 kg
 Power consumption: 400 Watt
 Fuses: 2 x 2.5 A

Thermometer: high precision with capillary bulb

Same specifications for both models:

Operating Voltage: 230 V - 50 Hz
 Thermostat: automatic, adjustable 0-200 °C
 Timer: manual from 0 to 120 minutes
 2° Thermostat: bi-metallic certified
 Green LED: timer, orange LED: heating, red LED: alarm
 Made in Italy - Warranty 1 year
 User/Service manual in IT, GB, FR



GIMETTE 21

35621

- 35621 GIMETTE 21 - hot air sterilizer
- 35628 GIMETTE 28 - hot air sterilizer
- 35629 GIMETTE 50 - hot air sterilizer



Fully automatic hot air sterilizer, with adjustable temperature from 0°C to 200°C, kills off even particularly resistant micro-organisms.

Stainless steel structure is powder painted, except for the door, to assure maximum heat and shock resistance over time. Four perforated, anodized aluminium trays make hot air circulation easier. Capacity approximately 20 l, 28 l and 50 l. A second safety thermostat triggers in case temperature should exceed 230°C.

SPARE ACCESSORIES

STERILIZER	TRAY	GASKET	RESISTOR 600 W
Gimette 21	35610	35614	35639
Gimette 28	35611	35615	35639
Gimette 50*	-	35617	35639

*Needs 2 resistors



GIMETTE 28

35628

Red LED indicates any anomaly in thermoregulation and consequent starting of safety thermostat.

TECHNICAL SPECIFICATIONS

	GIMETTE 21	GIMETTE 28	GIMETTE 50
Inside dimensions mm:	300x250x260	380x250x260	405x340x350
Approx. volume	20 dm ³	28 dm ³	50 dm ³
Outside dimensions mm:	440x340x400	550x340x400	605x460x480
Weight:	13 kg	17 kg	24.5 kg
Power consumption:	600 Watt	500 Watt	1200 Watt

Same specifications for 3 models:

Operating Voltage: 230 V - 50 Hz
 Fuses: 2 x 4 A (35621, 35628) 2 x 8 A (35629)
 Timer: manual from 0 to 120 minutes
 Thermostat: automatic
 Thermometer: high precision with capillary bulb
 2° Thermostat: bi-metallic certified
 Green LED: timer, orange LED: heating, red LED: alarm
 Made in Italy - Warranty 1 year
 User/Service manual in IT, GB, FR

PRESTIGE CLINICAL AUTOCLAVES: EXCELLENCE THROUGH DESIGN



35709



Only 335 mm

340 mm

Manual in: GB, FR, IT, DE, ES, PT, NL, DK, NO, SE, GR

code	PRESTIGE MEDICAL AUTOCLAVES
35709	Prestige autoclave 9 litres
35712	Prestige autoclave 12 litres
35720	Silicone sealing gasket
35724	Depressurization valve - since 2011

PRESTIGE AUTOCLAVES - class N

Prestige is one of the world's largest selling and most cost effective automatic autoclave available, with an enviable reputation for reliability, durability, safety and quality.

- method recommended by healthcare professional worldwide including the World Health Organisation (WHO)
- each autoclave is computer tested and issued with a unique Performance Test Certificate
- at only 4.5 kg net weight, offers full device portability
- supplied with basket and multilingual user manual

Recommended for infection control not only in hospital and general medical and dental surgeries, but also in veterinary, chiropody, professional beauty, tattooists, acupuncture, laboratories and schools.

Comply with: IEC 61010 (product safety), BS3970 part 4 (pressure vessel only), BS 5500 (pressure vessel).

TECHNICAL SPECIFICATIONS

	35709	35712
Capacity:	9 l	12 l
Chamber internal dimensions (D/H)	210/236	210/328
Maximum instrument length (diagonal):	228 mm	290 mm
Maximum loading weight:	3 kg	4 kg
Width/height:	340/335	340/420

Same specifications for 2 models:

- Sterilizing time: 11 minutes
- Cycle time (nominal): 22 minutes
- Operating pressure: 1.40 bar
- Sterilizing temperature: 126 °C
- Operating voltage: 230 V - 50-60 Hz - Power 1,250 Watt
- Made in UK - Warranty: 1 year



35712

GIMA VERTICAL AUTOCLAVE H100 - 9 LITRES - CLASS N

• **35746 H100 GIMA AUTOCLAVE - 9 litres - 230 V** 
Safe and easy to use autoclave to sterilize surgical instruments and hand-pieces which can be sterilized up to 125°C, with a sterilization cycle of 15 minutes only. External frame of painted steel and stainless-steel 18/10 body without any welding. Equipped with three safety valves. Made in Italy.

Safety systems

- safety lock to prevent opening of the door during the sterilization cycle; the door can only be opened when pressure inside the chamber is levelled to the ambient one
- safety valve for vapour exhaust in case of damage with inside overpressure > 2.5 bar. Safety valve TUV certified (PED IV)
- safety thermostat which occurs if the inner temperature of the chamber rises over 135°C
- safety valve kit to adjust pressure if it rises over 2.0 bar
- thermodynamic vacuum

Complies with 93/42/EEC Class IIb, IEC601, EMC

• **35747 SEALING GASKET** for H100 with serial number: A, D, E, F, K, L. Please advise if different serial number.

STANDARD ACCESSORIES

- Stainless steel basket int: Ø 195xh 183 mm
ext: Ø 210xh 210 mm with feet
- Electric cable
- User manual in GB, IT, ES on request FR, DE
- Distilled water bottle 1 l

TECHNICAL SPECIFICATIONS

- External size: 250x385xh 310 mm
- Size of the sterilizing chamber:
Ø 220 mm - h 235 mm
- Removable basket: Ø 210 mm - h 210 mm
- Sterilizing liquid: distilled water
- Absorbed power: 1500 Watts
- Operating voltage: 230 V - 50/60 Hz
- Fuses: type 6.3 x 32 mm - 8A
- Operating temperature: 125 °C
- Sterilizing time: 15 minutes
- Operational pressure:
1.3/1.6 bars (130/160 KPa)
- Net weight: 13.3 kg
- Warranty: 1 year



35746

GERMY GIMA PLUS: GERMICIDAL ULTRAVIOLET LAMPS



AVAILABLE IN 3 SIZES



35751

- 35750 GERMY GIMA PLUS 8 W - 38x20xh 17 cm
- 35751 GERMY GIMA PLUS 15 W - 50x24xh 20 cm
- 35752 GERMY GIMA PLUS 30 W - 96x24xh 20 cm
- 35754 SPARE NEON LAMP - 8 Watt
- 35755 SPARE NEON LAMP - 15 Watt
- 35756 SPARE NEON LAMP - 30 Watt

GERMY GIMA PLUS: ULTRA VIOLET LAMPS

These instruments incorporate a germicidal ultra-violet lamp which rapidly destroys every micro-organism hit by its rays. Recommended to keep the instruments stored inside sterile. Instruments previously sterilized can be preserved for a long time and they are always ready for use (UV treatments do not generate heat).

An inside supporting grate keeps instruments raised from reflecting surface which enables both surfaces to be uniformly irradiated, improving the UV germicidal action.

Operator safety is guaranteed by a micro switch which extinguishes the lamp if door is opened.

Solid construction, painted steel outside and reflecting stainless steel inside.

Installation on table or wall.

Operating voltage: 230 V - 50/60 Hz - 1 A

Made in Italy.

HYDRA EVO ELECTRONIC 15 OR 18 L STEAM AUTOCLAVE - N

- 35658 HYDRA EVO AUTOCLAVE - 15 litres - 230 V
 - 35659 HYDRA EVO PLUS AUTOCLAVE - 18 litres - 230 V
- Automatic steam autoclaves for the sterilization of unwrapped instruments. Closure system with an operator safety pivot. Thermodynamic system for the ejecting of the "cool" air locks.

Two sterilization cycles: 121°C and 134°C

Automatic phases of pre-heating, sterilization cycle and drying.

Pre-set, non-modifiable cycles

All cycles are pre-set at the factory and guarantee perfect and safe sterilization of treated materials. There is no way the operator can manipulate or alter the cycles, and this safeguards against risks deriving from human error.

Pre-set temperatures

The temperatures set for our autoclave cycles are 134°C and 121°C. The 134°C cycles are normally used for the sterilization of solid and ferrous materials. 121°C cycles are normally used for sterilization of thermoplastic and delicate materials.

Water tank

Hydra EVO only has one water tank. This tank must be filled with distilled or demineralized water and acts as a container for collecting the used water which is then re-utilized for new cycles.

Safety on the door

Each door is equipped with 2 locks:

- a mechanical one which does not open when pressure is exerted
- a dynamic one, that operates thanks to a special form of door seal

Safety devices installed

- Certified safety valve
- PED on sterilization chambers
- Insulation of the chamber with certified ceramic material.



35658

93/42/EEC
73/23/EEC
93/336/EECMedical device
Low tension
Electromagnetic
Compatibility

CE 0434

TUV
CHAMBER TEST

Controls on the Autoclave

- Control of the water that enters into the chamber
- Safety Thermostat
- Time Control

The sterilization chamber is completely stainless steel AISI 304 and it is heated by a band shaped heating element which grants uniformity of the heat. Supplied with four aluminium trays and one key for their extraction.

User manual available in English, French, Italian, Spanish.

- 35671 Sealing GASKET - spare
- 35669 HEATING BAND DHY A035 for 35650, 35654
- 35670 HEATING BAND DXB A835 for 35658, 35659

*Need serial number of autoclave

TECHNICAL SPECIFICATIONS

Stainless steel chamber: Ø 24.5 x 32 cm Ø 24.5 x 40 cm (Plus)
External size: 44 x 38 x 50 cm (W x H x D)
Net weight: 35 kg
2 sterilization cycles: 121°C and 134°C
Operating Voltage: 230 V±10% - 50/60 Hz
Power consumption: 1700W
Class N
Made in Italy - Warranty: 1 year



Cycles	Materials	Sterilization time	Drying time	Max load	Working pressure
Not wrapped 121° C	•Fragile solids •Rubber solids •Glass •Turbines if indicated by producer	20 min.	5 min.	2.8 kg 700 g load in any tray	1.2+1.3 bars
Not wrapped 134° C	•Stainless metal solids •Turbines if indicated by producer	10 min.	5 min.	2.8 kg 700 g load in any tray	2.1+2.2 bars

NUBYRA 6 LITRES STEAM AUTOCLAVE - CLASS N



35647

- 35647 NUBYRA AUTOCLAVE - 6 litres - 230 V

Electronic steam autoclave for the sterilization of unwrapped instruments. 2 fully automatic, microprocessor controlled, sterilization cycles: at 134°C or 121°C with short or long automatic drying.

LCD display with visualization of temperature and pressure for total control of sterilization cycle. Easy closure system with double safety sensor. Air pockets automatic ejection system: thermodynamic system for the ejection of "cold" air pockets. Anodized aluminium chamber, 2 electronic temperature sensors (1 inside chamber and 1 outside) and electronic transducer for better control of pressure.

Supplied with 3 aluminium trays.

- 35648 GASKET - spare

93/42/EEC
2014/35/UE
2014/30/UE
EN 13060Medical device
Compatibility

CE 0051

Cycles	Materials	Sterilization time	Drying time	Max load	Working pressure
Not wrapped 121° C	•Fragile solids •Rubber solids	18 min.	5 min. short dry or 15 min long dry	1 kg 500 g load in any tray	1.1+1.2 bars
Not wrapped 134° C	•Fragile solids •Rubber solids	6 min.	5 min. short dry or 15 min long dry	1 kg 500 g load in any tray	2.1+2.2 bars

TECHNICAL SPECIFICATIONS

Anodized aluminium chamber:
Ø 17x26.5 cm - 6.11
External size: 44.5x48x35 cm
Trays size: 1 large 15x24x2 cm
2 small 11x24x2 cm
Maximum load: 1 kg (short dry)
0.5 kg (long dry)

2 sterilization cycles: 121°C and 134°C
Operating voltage: 230V - 50/60 Hz
Max absorbed power: 1,350 Watt
Net weight: 27 kg Class N
Made in Italy - Warranty: 1 year
User manual: GB, IT (FR, ES on request).

EUROPA B EVO: CLASS B AUTOCLAVE 15 AND 24 l

EN13060

Tray holder with 4 aluminium trays



Supplied with 1 closed tray holder, 4 aluminium trays, 1 double-use key for tray extraction and door adjustment, water loading and unloading hoses, chamber cleaning sponge and integrated osmosis system (35657 only)



35653

CE 0434 TÜV CHAMBER TEST



Constant control and monitoring of the entire autoclave functional system.



Sterilization Cycles 121°C-134°C suitable for both enveloped and free materials. All cycles are for type-B loads.

As regards to safety in health practice, sterilisation is the first aspect to consider. Autoclaves offer physical and legal safety. This is why autoclaves must be chosen according to rational logics and based on professional and not only cost-related evaluations.

With the new EN 13060 standard, the choice of the right autoclave is now easier for professionals: they must choose a certified, adequate model, based on the type of materials to sterilise. A B-type loads autoclave allows to sterilize hollow materials such as handpieces and turbines and porous materials (overalls, gauze...).

P.I.D. System (Proportional Integral Derivate)

It represents the top of closed loop controls. P.I.D. ensures a constant control and monitoring of the whole operating system of the autoclave, acting automatically in case of anomalies or incorrect technical and electronic parameters.

Internal tanks

All the autoclaves are equipped with an internal tank for pure water and another for used water. Each tank is equipped with probes to detect the minimum and maximum water levels.

Preset temperatures

The preset temperatures used in our autoclaves cycles are 134°C and 121°C. 134°C cycles are normally used for sterilization of solid and ferrous materials. 121°C cycles are normally used for sterilization of thermoplastic and delicate materials.

Ease of use

Sterilization cycle is selected by pushing one button and activated by pushing another. First button allows to scroll and view data about all sterilization cycles on the display and select the cycle that suits your materials best, second button automatically starts the whole sterilization cycle. It is impossible to make mistake or choose an inadequate sterilization cycle. In case of any error or warning a series of messages and LEDs will inform you about the problem.

Fully automatic cycles

All cycles are fully automatic, with all steps managed by the leading-edge computer board with a powerful microprocessor. Each step (vacuum, preheating, exposure time, drying) is automatically monitored, assisted and handled. There is no need for human intervention in cycle management.

Cycles without operator intervention and with autoshutdown In sterilization cycles an automatic function will trigger an anti-

35657



Autoclave equipped with integrated printer

condensation process and auto-shutdown if the operator is not by the machine when the cycle ends.

Test cycles

Our autoclaves are equipped with test cycles for periodic control by means of physical and functional tests.

Helix test, to assess vacuum capacity in hollow bodies.

Bowie & Dick test to evaluate vacuum capability in hollow bodies. Vacuum test to evaluate vacuum retaining capability.

Constantly monitored cycles

A device constantly controls and monitors the sterilization cycles. Any anomaly or uncommon feature is quickly detected and immediately blocked if it jeopardises the sterilization cycles. The operator is warned of the anomaly by a message.

All cycles ensure sterilization of B-type loads

All the sterilization cycles feature the fractional vacuum system as well as the controls of parameters that ensure sterilization of B-type loads. Therefore, even if the type of cycle chosen is incorrect the sterilization carried out on the material will be equally adequate.

Integrated Osmosis system (35657 only)

Inverse osmosis is a safe water treatment system that eliminates even the tiniest polluting particle, to guarantee bacteriological purity. It works through an osmotic membrane which is able to filter water down the molecular levels.

code	CLASS B AUTOCLAVES
35653	Europa B Evo Autoclave - 15 l
35657	Europa B Evo Autoclave - 24 l with integrated osmosis system
SPARES	
35672	Bacterial filter for Europa B conical threading 1/8 Compatible also with W&H, Cominox, Mocom, Mediline, Euronda
33250	Thermal paper 57mm x 25m (pack of 5 rolls)

Cycles	Working pressure min-max	Minimum time of the total cycle* - minutes	
		Europa B EVO	Europa B EVO 24
121° C Wrapped	1.04 - 1.30	60 min. (25+18+17)	56 min. (25+18+13)
121° C Unwrapped	1.04 - 1.30	49 min. (25+18+6)	55 min. (25+18+12)
134° C Flash	2.02 - 2.38	31 min. (25+4+2)	33 min. (25+4+4)
134° C Wrapped	2.02 - 2.38	47 min. (25+5+17)	43 min. (25+5+13)
134° C Unwrapped	2.02 - 2.38	36 min. (25+5+6)	42 min. (25+5+12)
134° C Prion	2.02 - 2.38	62 min. (25+20+17)	58 min. (25+20+13)

*The total time includes: vacuum, pre-heating time, cycle and drying phase.

The times are to be intended for a fully loaded autoclave.

All sterilization cycles have 3 stages of vacuum.

Vacuum and pre-heating time can vary depending on the conditions of autoclave from 25 to 35 minutes

TECHNICAL SPECIFICATIONS

	35653	35657
	Europa B - 15 l	Europa B - 24 l
External size mm (WxHxD):	510x390x590	510x390x730
Chamber size mm (Øxdept):	245x320	245x500
Operating voltage	230V - 50/60 Hz	230V - 50/60 Hz
Max absorbed power	1,700 W	2,200 W
Weight kg:	54	58
Built in printer:	yes	yes
Manual closing:	yes	yes
Fitting for pura deioniser:	yes	yes
PID system	yes	yes

ANDROMEDA VACUUM XP AUTOCLAVE WITH PRINTER 15-21 LITRES

Twin tanks for pure and used water: by using always pure water, the internal components are protected, with benefits in maintenance and service costs

Door opening block with electromagnet



Door gasket

Bacteriological filter

CLASS S



Stainless steel chamber, uniformly heated by a band heating element

Electronic printer

Digital control

93/42/EEC
73/23/EEC
93/336/EEC

Medical device
Low tension
Electromagnetic
Compatibility

Andromeda Vacuum is supplied with printer built into the drive board. The printer document certifies the sterilization by indicating all the data related to the cycle.



- 35651 ANDROMEDA VACUUM XP - 15 litres - 230 V
 - 35662 ANDROMEDA VACUUM XP - 21 litres - 230 V
- Pre-and post-vacuum:** Andromeda Vacuum is provided with powerful vacuum pump which, at the beginning of the cycle, ejects the airpockets from the sterilization chamber, and at the end of the sterilization phase ensures a very good drying.
- Rapid preheating:** A very new method of preheating, through a special band heating element, gives a high reduction of the preheating times.
- Guaranteed sterilization:** A sophisticated electronic device gives a constant monitoring of pressure, temperature and time. In case of anomalies there will be an electronic lock of the autoclave and the display will indicate the anomaly.

TECHNICAL SPECIFICATIONS

External size: 45x39x54 cm (35651), 45x39x66 cm (35662)
 Chamber dimension: Ø 24.5x32 cm depth (35651),
 Ø 24.5x43 cm depth (35662)

Weight: 50 kg
 Operating Voltage: 230 V - 50/60 Hz
 Power consumption: 2000 Watt
 Made in Italy Class S

Cycles



Andromeda Vacuum is provided with 5 cycles of sterilization: 121° C and 134° C for unwrapped and wrapped instruments, and a "Flash" cycle for the fast sterilizations.

Cycles	Temperature	Max load	Pressure	Total time*
Program 1 Unwrapped instruments	134° C	2.8 kg	2.2	33
Program 2 Wrapped instruments	134° C	2.8 kg	2.2	38
Program 3 Unwrapped instruments	121° C	2.8 kg	1.2	42
Program 4 Wrapped instruments	121° C	2.8 kg	1.2	46
Program 5 Flash	134° C	2.8 kg	2.2	16

* pre-heating - vacuum - cycle - drying in vacuum

User manual available in English, French, Spanish, Italian, German

"Night" cycle with anti-condensate device

Andromeda Vacuum can work also without the operator presence as all functions are automatic. At the end of each cycle a special device eliminates the backwater of condensate, afterwards there is the automatic sign off, but with electronic storage.

Safety of the operator: Andromeda Vacuum has an electromagnetic block device on the door. The door opens only with atmospheric pressure into the chamber, and after having pressed the push button.

Completely computerized monitoring of all automatic functions, and auto-diagnosis of each component. The total automation of each phase of the cycle prevents any possible human error, also from inexperienced personnel

Timed start, with positioning in "Stand-by" at 80°C and automatic switch off after one hour not in use.

Automatic filling up of the water: a pump allows the filling up, and stops automatically when the maximum level is reached.



- 35671 SEALING GASKET - for Andromeda and Europa
- 35672 BACTERIAL FILTER - for Andromeda and Europa
- 35673 VAPOR LINE STERILIZATION INTEGRATOR - for Andromeda and Europa
- 35652 THERMAL PAPER 60 mm x 25 m

DISTILLER: SYSTEM OF WATER DISTILLATION



Size Ø 20 cm x h 36 cm

35690

• 35690 WATER DISTILLER

The autoclaves must run with distilled or demineralised water to avoid problems on electrovalves and on internal mechanism and white traces of limestone on the sterilized tools and devices. Distiller produces 100% distilled water in a cheap and safe way. It produces 4 litres in about 7 hours. It is equipped with an automatic control thermostat with block system at the end of operation.

Supplied with 6 active coal filters, 1 detergent, 1 container for produced distilled water. Operating Voltage: 220 V - 50-60 Hz.

- 35691 COAL FILTERS FOR DISTILLER - box of 12
- 35692 DETERGENT FOR DISTILLER

DIGITAL SEALING MACHINES WITH/WITHOUT DOT MATRIX PRINTER



35909, 35910

- 35909 D-400 SEALING MACHINE without printer
 - 35910 D-500 SEALING MACHINE with dot matrix printer
- Continuous sealing machines for medical pouches according to DIN rules 58953-7:2010 with or without dot matrix printer. They allow a 12 mm multi-line seal and features stand-by function and automatic infeed through photocell. D-500 is equipped with built-in printer to print different data on the bag (sterilization/expiry dates) during the sealing process in order to provide constant control on the sterility of your instruments, especially when the paper layer of the

sterilization bag is less tight, after 30 days, and consequently losing instruments sterility. Built in epoxy coated stainless steel. D-400 and D-500 are sophisticated units controlled by a microprocessor and equipped with a device to adjust temperature (displayed by LCD) and printing parameters. **The sealing pressure is automatically adjusted according to the material thickness.** It also guarantees 30 mm safety distance between seal and product, according to DIN rules. Easy to use and maintenance-free, they are the ideal solution for clinics and hospitals. Compatible for sealing with Tyvek rolls and envelopes. Made in Italy.



- 35912 INK-CARTRIDGE D-500/700 - spare part

TECHNICAL SPECIFICATIONS		
	35909	35910
Infeed speed	6 m/min	
Temperature control	by digital thermoregulator	
Sealing temperature	40°±200° C	40°±180° C
Temperature tolerance	±5°C	
Seal	Multiline	
Seal width	12 mm	
Adjustable free edge	0 ÷ 30	
Power supply	230 V-50 Hz-single phase	
Absorption	500 W	600 W
Dimensions	473x235xh 181 mm	
Net weight	11.5 kg	12 kg

SEALING MACHINES WITH VALIDATION SYSTEM



35915, 35916

COMPLYING WITH
ISO 11607 P.2,
ISO/TS 16775

- 35915 D-600 ROTARY HEAT SEALER - without printer
 - 35916 D-700 ROTARY HEAT SEALER - with printer
- With validation system complying with ISO 11607 P.2 rule. GIMA 600 and GIMA 700 have been designed to continuously monitor, during the whole sealing phase, all critical process parameters: Temperature, Speed, Pressure. They guarantee sealing in full respect of EN 868-5 / ISO 11607 P.2 rules, provide real-time monitoring of working temperature, applied force

and running speed, time used during the sealing process. All sealing data can be recorded on an external carrier which can be linked to the sealer through a USB port placed on the unit. They are controlled by a microprocessor. Operator's interface is a clear 2 line display, integrated in an ergonomic keyboard placed at the upper side of the sealer in an extremely user friendly position. Simple use, high reliability, they are the ideal solution for hospitals and clinics. Compatible for use with Tyvek rolls and envelopes. Made in Italy.

- 35912 INK-CARTRIDGE D-500/700 - spare

TECHNICAL SPECIFICATIONS		
	35915	35916
Sealing width	12 mm	12.5 mm
Seal	multiline	
Sealing speed	6 m/min	8.5 m/min
Temperature adjustment/ tolerance	10-200°C ± 5 °C	
Alarms functioning out of tolerance	yes	yes
Automatic stand-by	yes	yes
4 key membrane keyboards	yes	yes
LCD display 2 lines	6 characters	8 characters
Multilanguage menu	yes	yes
USB port	yes	yes
Data storage on pendrive	yes	yes
Power	230 V / 50 Hz - single-phase (on request 110 V, 60 Hz)	
Max electrical input:	500 W	500 W
Dimensions - Weight:	473x235x181 mm - 12.5 kg	

STEAM AND DRY HEAT ADHESIVE TAPE INDICATORS



35846

35842

MEET EN ISO 11140-1 : 2014
FOR PART APPLICABLE TO TYPE 1 E1

STEAM AND DRY HEAT TAPE INDICATORS

Gima range of tapes is specially formulated for packing purposes as well as to show visibly that the pack has undergone a sterilization cycle. The backing of the different tapes is made of strong, semicreped, impregnated paper which gives excellent conformability during the application. Sterile tapes unwind easily and can be torn by hand without difficulty.

Special adhesives formulated to withstand high temperature and humidity ensure excellent bond to paper, plastic, non-wovens, board, metal, glass and linen.

Each tape is individually packed with due date. Made in Italy.

TAPE INDICATOR - 50 m	Width 19 mm	Width 25 mm	Minimum order
Dry Heat Tape - hot air sterilizer	35842	-	12 rolls
Steam Tape - autoclave	35846	35847	12 rolls

D-351 SEALING MACHINE: ELECTRO-MAGNETE OPERATION

CE



Electromagnet closing

• 35900 D-351 IMPULSE SEALING MACHINE

Compact impulse medical sealers, conform to DIN 58953 P.7 rules, specially designed to be used in medical, dental, oculistic surgeries and test laboratories.

Main features: sealing and cutting length 35 cm - Safety check with alarm. Main board with temperature control to avoid overheating of the sealing wire - Sealing bars closed by electromagnet. Complete with foil-roll dispenser and built-in cutting device.

Easy: by the pressure of only one finger, without using levers, the bars close automatically. The electro-magnet guarantees a steady sealing pressure for the whole set period. The sealing bar opens automatically at the end of the cycle, requiring no action by the operator.

Quick: the electro-magnetic system allows a substantial saving of the packing time. Quick foil feeding.

Safe: the machine does not start the sealing cycle if there is an object with a thickness over 3 mm between the bars.

The electronic temperature control through a NTC probe provides a perfect temperature accuracy from seal to seal.

The electronic alarm function avoids any overheating. Made in Italy.

• 35902 TEFLON - spare

• 35903 RESISTOR - spare

TECHNICAL SPECIFICATIONS

Sealed materials: paper/polyethylene/polyester

Sealing length: 350 mm

Sealing width: 8 mm as per DIN 58953-7:2010

Electronically controlled sealing time: 0.5 sec.

Cutting length: 350 mm

Foil-roll dispenser 350 mm

Power: 230V- 50/60 Hz single - phase

Max absorption: 700W, only during the sealing time

Dimensions: 44x17.5x31 cm

Weight: 18 kg

Built in accordance with CE Norms

GD-301 EVO SEALING MACHINE FOR CONTINUOUS HEAT SEALING



TECHNICAL SPECIFICATIONS

Flat sealing 12 mm

Sealing length 300 mm

Thermo controlled continuous heat sealing

Built-in cutting device

Fixed sealing temperature and sealing time

Manual actuation

Power 230 V / 50-60 Hz, single phase

Electrical input: 900 W

Protection degree IP 20

Sealer dimensions 452x248x146 mm

Roll-holder dimensions 458x412x242 mm

• 35928 GD-301 EVO SEALING MACHINE - machine only

• 35929 GD-301 EVO SEALING MACHINE - complete

Manual heat sealer for medical pouches and reels according to DIN 58953-7:2008. New models with 3 ceramic heater elements for a faster and more accurate sealing and improved infeed and outfeed guide to keep film flat (infeed) and prevent the film moving upward inside machine.

Available in 2 versions: compact without accessories (35928) or with sealer roll holder, cutter and plane (35929)

User friendly, reliable and extremely compact, ideal in dentistry, medical and veterinary laboratories.

Sealing bar 300 mm manually actuated by a lever.

Thermo controlled continuous heat sealing, to save consumables. Compact vertical design to reduce space at the minimum. Integrated, removable roll-holder, can stand alone apart from the sealer.

Usable only with polypropylene film coupled to medical grade paper and/or plastic envelopes suitable for steam sterilization.

• 35933 CERAMIC HEATING ELEMENTS - spare

• 35935 BLADES - kit of 5 - spare



TESTS FOR AUTOCLAVE



Notice "Sterilisé" and three stars drawing change colours

from white to dark brown to show safe sterilization of 121°C - 15 minutes or 134°C - 3.5 minutes

from white to black to show sterilization over safety margin 121°C - 20 minutes or 134°C - 5 minutes

EN 867 - Class D
ISO 11140 - Class 6

• 35849 "STEAM STAR" INDICATOR - autoclave - box of 1,000

Indicator for sterilization by autoclave with pressure 1 to 2 bar 120°C/135°C. No special stocking requirements. Safety and reliability. Made in Japan.

BOWIE & DICK TEST READY FOR USE



Colour change from dark to green



Test sheet before sterilization

Test sheet after sterilization Failed test

Test sheet after sterilization Correct test

• 35853 UPSTAR - "BOWIE & DICK" - test - 14x14x0.8 cm

The Bowie & Dick ready to use test pack is designed to control the proper functioning of steam autoclave and to test its ability to sterilize porous devices (compresses, fields, gowns, woven or non-woven,...).

- High sensitivity: detects any default.

- Easy interpretation.

- Stability of color change.

- Waterproof aluminium packaging

EN 867 - Class B
ISO 11140 - Class 2

ROLLS FOR AUTOCLAVE, STEAM AND ETO

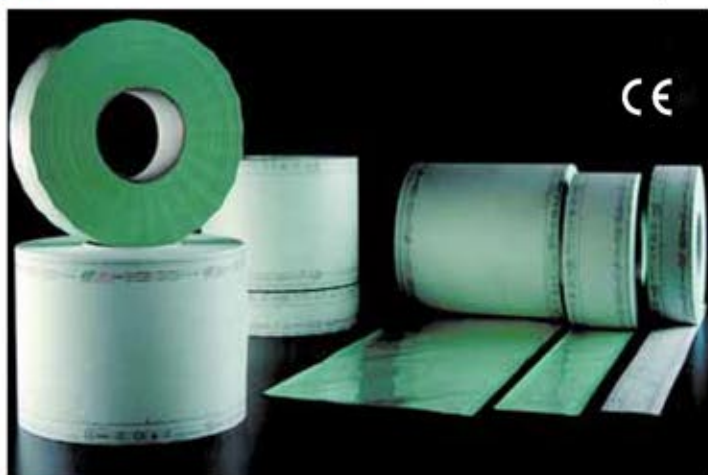

OTHER SIZES AVAILABLE

FLAT ROLLS for sterilization by steam or ethylene oxide gas
Flat rolls consist of transparent, polyester-polypropylene film coupled to medical grade paper which permit steam and gas penetration during sterilization. Steam and gas indicators provide clear colour changes when exposed to sterilization process. Each roll is 200 m long.

FLAT ROLLS FOR AUTOCLAVE, STEAM AND ETO

code		External m x mm	Internal m x mm	Minimum order
35810	Flat rolls	200x50	200x36	8 rolls
35811	Flat rolls	200x75	200x53	8 rolls
35812	Flat rolls	200x100	200x78	4 rolls
35813	Flat rolls	200x150	200x128	4 rolls
35814	Flat rolls	200x200	200x178	2 rolls
35817	Flat rolls	200x250	200x228	2 rolls
35815	Flat rolls	200x300	200x278	2 rolls
35816	Flat rolls	200x400	200x378	1 roll

GUSSET ROLLS FOR AUTOCLAVE, STEAM AND ETO

code		External m x mm x mm	Internal m x mm x mm	Minimum order
35871	Gusset rolls	100x100x25	100x78x25	4 rolls
35872	Gusset rolls	100x150x25	100x128x25	4 rolls
35873	Gusset rolls	100x200x30	100x178x30	2 rolls
35874	Gusset rolls	100x250x32.5	100x228x32.5	2 rolls
35875	Gusset rolls	100x300x40	100x278x40	1 rolls
35876	Gusset rolls	100x400x40	100x378x40	1 rolls

GUSSET ROLLS for sterilization by steam or ETO

Made with coated film PET 12/PP 40 green and 60 g medical white paper.

For sterilization of voluminous objects.

Each roll is 100 m long.

FLAT AND SELF-SEAL POUCHES FOR AUTOCLAVE



SELF-SEAL POUCHES
for sterilization by autoclave, steam or ethylene oxide gas

Self-seal pouches consist of light green, polyester-polypropylene transparent film coupled to medical grade paper which permit steam and gas penetration during sterilization.

Steam and gas indicators change colour when exposed to sterilization.

1. Reinforced corners to prevent dust from collecting near to the opening, reducing the risk of contamination during opening.

2. The laminated transparent film complies with the German standard EN 10/204. The medical paper conforms to the following standards: DIN 58953 (German), Pharmacopoeia 589 (French), pr EN 868-3 (European) and BS 6256 (English).

3. The chevrons allow rapid and correct opening.

4. These consist of one layer of laminated transparent film (special type polyester and copolymer polypropylene) and white damp-resistant medical Kraft paper, specially designed to assure a high anti-bacterial protection.

5. The heat-sealed lines (Multiline) are highly resistant and spaced equally; the external welding runs along the entire length of the pouch.

Reels and pouches are certified and are manufactured according to international standards DIN 58953 BS 6871, EN 868-5, CN 13485

OTHER SIZES AVAILABLE
minimum 10,000 pouches

FLAT POUCHES FOR AUTOCLAVE, STEAM AND ETO

code		External mm	Internal mm	Minimum order
35880	Flat pouches	100x300	78x285	1,000
35881	Flat pouches	150x200	128x185	1,000
35882	Flat pouches	150x250	128x235	1,000
35883	Flat pouches	150x300	128x285	1,000
35884	Flat pouches	150x400	128x385	1,000
35885	Flat pouches	200x300	178x285	1,000
35886	Flat pouches	200x350	178x335	500
35887	Flat pouches	200x400	178x385	500
35888	Flat pouches	250x400	228x385	500
35889	Flat pouches	250x500	228x485	500
35890	Flat pouches	300x400	278x385	500
35891	Flat pouches	400x600	378x585	500
35895	Special size pouches			10,000

SELF-SEAL POUCHES FOR AUTOCLAVE, STEAM AND ETO

code		External mm	Internal mm	Minimum order
35860	Self-seal pouches	90x165	68x150	1,800
35861	Self-seal pouches	90x230	68x215	1,800
35862	Self-seal pouches	140x250	118x235	1,200
35863	Self-seal pouches	190x330	168x315	1,200
35864	Self-seal pouches	190x400	168x385	1,200
35866	Self-seal pouches	300x450	278x435	400

BOWIE DICK TEST PACK

Package and manual in: GB, IT, ES, FR, PT, GR, DE.



Dimensions: 123x123x16 mm

• 35950 BOWIE DICK TEST PACK - box of 20 pcs

Used for daily monitoring of pre-vacuum steam sterilizer. Based upon the Bowie Dick test result the steam sterilizer is released for usage during the day. The Bowie Dick test detect failures like air leaks, insufficient vacuum, inadequate steam penetration.

- fulfill requirements of EN 285 and ISO 17665
- conform to ISO 11140 - 4 Type 2 / EN 867 - 4 class B (EU standard 7 kilo)
- independently tested to show performance similar to original pack
- clear blue - violet colour change
- easy to interpret and document
- non-Toxic / lead free

TYPE 5 MOVING FRONT

Conform to ISO 11140 - type 5



User manual: GB, IT, FR, ES,

Non-toxic / lead free

• 35952 TYPE 5 MOVING FRONT INTEGRATOR box of 1,000 pcs

Moving front integrators 134 °C - 3.5 min are giving you the best interpretation possible in case of any failure in your steam sterilization cycle. If temperature is not reached or holding time was too short the dark colour will not reach the accept area.

- shelf life: 5 years after production
- packed in white aluminium re.closable bags
- very easy interpretation of result
- complete indicator area sealed of by foil

TYPE 4 STEAM INDICATOR



• 35954 TYPE 4 MULTI-VARIABLE STEAM STRIPS - box of 250 dual strips

Type 4 multi-variable steam indicator strips are designed to be used in steam sterilizers operating at 134 °C - 3.5 min. The indicator strips will provide assurance of steam penetration into the packs. The water based, non-toxic chemical indicator in compliance with ISO 11140-1 will show a clear colour change from blue to black after successful steam sterilization. Test indicator strips are cost effective and can be divided into two separate pieces for economical use.

TYPE 6 STEAM INDICATOR



• 35955 TYPE 6 EMULATING STEAM STRIPS - box of 250 strips

Type 6 emulating steam indicator strips are designed to be used in steam sterilizers operating at 121 °C - 15 min and 134 °C - 3.5 min. The cycle verification indicators can be used in every pack and will provide assurance of steam penetration into the packs and presence of all critical parameters of steam sterilization cycle.

The water based, non-toxic chemical indicator in compliance with ISO 11140-1 will show a clear and accurate colour change from blue to lilac after successful steam sterilization.

BOWIE DICK HELIX TEST



Includes: cotton bag, helix device (tube 1.5 m), 100 tests and user manual GB, FR, IT, ES.

• 35951 BOWIE DICK HELIX TEST PACK - box of 100 pcs

Helix devices and their indicators have proven that they detect failures during each cycle much earlier than other chemical indicators / integrators. The EN 285: 2009 are specifying the Helix test (Hollow A) to be used as Bowie Dick Test as well as Batch Monitoring when hospitals are sterilizing hollow loads, Next to that this Bowie Dick Helix Test is an obligatory test for class B Bench Top Steam sterilizers.

- conform to ISO 11140 - 1 Type 2 - EN 867 part 5 class B
- clear transition of color into pink
- easy to interpret and document
- non-Toxic / Lead Free
- PCD guaranteed for 500 Cycles (134°C - 3,5 min)

TYPE 5 STEAM INDICATOR

Conform to ISO 11140 - type 5



Package and manual in: GB, IT, FR, ES, PT, GR, DE

Non-toxic / lead free

• 35953 TYPE 5 STEAM INTEGRATOR - box of 500 pcs

Integrators can be used in addition to the batch control Helix which allow to release load. It allow to re-affirm sterilization condition inside trays or containers.

- SV: 134 °C - 3.5 min / 121 °C - 15 min
- shelf life: 5 years after production
- packed in an easy dispensing carton
- clear colour transition from blue into pink of lacquer covered indicator

TYPE 5 EO INDICATOR



• 35956 ETHYLENE OXIDE STRIPS - box of 250 dual strips

Type 5 Ethylene Oxide (EO) indicator strips are designed to be used at E.O. sterilizers in compliance with ISO 11135. The indicator strips can be used in every pack and will provide assurance of E.O. gas penetration into the packs. The water based, non-toxic chemical indicator in compliance with ISO 11140-1 will show a clear colour change from white to yellow after successful sterilization. Test indicator strips are cost effective and can be divided into two separate pieces for economical use.

SEAL CHECKER

Dimension: 175x75

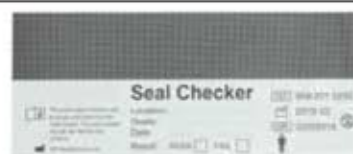

Suitable for all rotary heat sealers

• 35957 SEAL CHECKER - box of 250 pcs

The ISO-11607 standard is specifying a routine, daily check of your heat sealers.

The seal checker is a way to perform the test required and to document which sealer, which day, which person did perform the test and to easily show results of your heat sealer capacity of properly heat seal your pouch.

When place inside a pouch and seal, the sealed area will be darker and can be easily read whether the seal is consistent, regular and completely without any gaps.

PILL MANAGERS



PILL PULVERIZERS
See page 81.

VET PRODUCTS

- **CLOGS**
See page 24-25
- **TOURNIQUETS**
See page 56
- **SCALPELS and BLADES**
See page 41
- **THERMOMETERS**
See page 75-78
- **VET BAGS**
See page 57-60
- **TROLLEYS**
See page 113-123
- **BANDAGES, GAUZES, PLASTERS**
See page 336-342
- **BARRYCIDAL 30 PLUS DISINFECTANT**
See page 351

BIOPSY PUNCHES



BIOPSY PUNCHES
DERMAL CURETTES
See page 42.

SURGICAL CLIPPER



SURGICAL CLIPPER
See page 42.

SUTURES



SUTURES AND SKIN STAPLER DEVICE
See page 39-40.

SUCTION UNITS



SUCTION UNITS
See page 161-164.

ELECTROSURGERY



ELECTROSURGICAL UNITS
See page 181-186.

ELECTROSURGERY



ELECTROSURGERY ACCESSORIES
See page 187-192.

HEADLIGHTS



HEADLIGHTS
See page 195-198.

EXAMINATION LIGHTS



HALOGEN AND LED EXAMINATION LIGHTS
See page 199-205.

3M LITTMANN® STETHO



3M LITTMANN® CLASSIC II
3M LITTMANN® CARDIOLOGY
See page 235-238.

SURGEON BRUSHES



SCRUB KIT
CHLOREXIDINA SCRUB KIT
IDO-POVIDONE SCRUB KIT
See page 350.

DIGITAL PET SCALES FOR LARGE AND SMALL ANIMALS

UP TO
300 KG

80211



Both scales are supplied with handle

- 80210 DIGITAL VET SCALE - metal platform
 - 80211 DIGITAL VET SCALE - stainless steel platform
- High reliable and professional full electronic scale. Robust platform with a separate LCD digital display. Overload and low battery function. Switchable kg/lb/st. Made in Europe.

• 80216 AC POWER

TECHNICAL SPECIFICATIONS

Capacity/Sensitivity: 300 kg / 100 g Minimum measurable: 2 kg
Platform size: 600x800 mm Power: 9 V alkaline battery



Manual in DE, GB, FR, ES, IT, GR, CZ.

Taring functions switchable to kg/lb

- 27266 SOEHNLE 8320 FOLDABLE SCALE
 - 27271 CARRYING BAG
- Foldable scale with magnetic lock for easy transport.

TECHNICAL SPECIFICATIONS

Capacity: 15 kg Sensitivity: 10 g
Dimensions: 395x315x105 mm (closed) - 740x315x53 mm (open)
Alkaline battery 2x1.5V AAA - not included
Weight: 1.9 kg Warranty: 2 years Made in Germany



- 27258 DIGITAL PET SCALE - medium
 - 27259 DIGITAL PET SCALE - large
- Precise full electronic multifunctional scale, designed for measuring your pet's weight available in two sizes. Quality product with very competitive price. Minimal measuring weight: 2 kg. Made in Europe.

Tray 530x290 mm

Lb/kg/st switchable by user

LCD display 25 mm

Overload and low battery indication

Tare and automatic hold functions



- 27261 DIGITAL SMALL PET SCALE

TECHNICAL SPECIFICATIONS

Capacity/Sensitivity: 20 kg / 10 g (27261) - 100 kg / 100 g (27258-27259)
Minimum measurable weight: 20 g (27261), 2 kg (27258-27259)
Dimensions: 355x635 mm (27258) - 620x830 mm (27259)
Lithium battery: included Automatic switch-off

DIAGNOSTIC AND OPERATIVE VETERINARY TABLES



Pack size: 121x15x90 cm
Size: 120x58xh 85 cm
Weight: 23 kg
Load: 60 kg

- 80300 VETERINARY EXAMINATION TABLE
- Veterinary operating table with enamelled tubular steel frame, with AISI 304 15/10 stainless steel top with hole and a liquid tray holder underneath. Lateral hook to immobilize animals. Made in Italy.



Size: 118x56xh 85/102
Weight: 48 kg
Max load: 90 kg

- 80301 VETERINARY OPERATION TABLE
- Veterinary operating table with electric lift (82/102 cm), baked enamelled steel tubular frame and AISI 304 stainless steel top (120x56 cm) with hole and a liquid bucket holder underneath. Manual Trendelenburg 15° and Antitrendelenburg up to 15°. Lateral hook to immobilize animals. Made in Italy.

S/S INSTRUMENTS

80001



80000



- 80000 Durante forceps - 15 cm
- 80001 Terza palpebra forceps - 11 cm
- 80002 Long Hartmann - 14.5 cm
- 80005 Mouth opener - 7 cm
- 80006 Mouth opener - 11 cm
- 80007 Mouth opener - 15 cm
- 80010 Rodent mouth opener - 6 cm
- 80011 Rodent mouth opener - 8.5 cm

80007



80002

80010

URINE STRIPS

- 24100 VETERINARY URINE STRIPS - 11 parameters - bottle of 100 strips
- For examination of glucose, ascorbic acid, ketones, protein, ph-value, blood, nitrite, leukocytes, specific gravity, bilirubin, urobilinogen. Each box includes a manual for interpretation of results in each of the following animal: horse, pig, cattle, sheep, goat, dog, cat, bunny and guinea pig. Made in Germany by Analyticon.



Performs highest quality standard. Made in Germany

VETERINARY ECG - 1 OR 3 CHANNEL

- 33305 VE-100 - 1 channel ECG
- 33306 VE-300 - 3 channel ECG
- 33336 ECG-Viewer software (GB, IT, FR, ES, RU, PT, PL, TU) for 33306
- complete digital design
- LCD display waveforms, parameter configuration
- high resolution thermal printer
- built in rechargeable Li-Ion battery for 6.5 hours use (AC/DC supply)
- complete digital filter, avoid baseline drift, AC, EMG interfere
- baseline automatically adjustable, optimizes printing position
- selectable auto/manual operation

Features of VE-300 only

- 12 leads simultaneous acquisition
- automatic ECG parameter measurement and analysis
- support USB ink-jet printer for 12 leads printing
- 120 patient data storage and transfer by USB flash disk, Ethernet or series port
- review and management of ECG data on Window PC with software (optional 33336)



Internal software: GB, IT (33305/6), DE, FR, ES (33305 only)

- 32963 THERMAL PAPER ROLL 50mm x 25m for 33305
- 32964 THERMAL PAPER ROLL 80mm x 25m for 33306
- 33318 RE-CHARGEABLE LITHIUM BATTERY 2200 mAh
- 33319 5-LEAD VETERINARY ECG CABLE - spare

STANDARD ACCESSORIES

- 5-lead veterinary ECG cable (Ø 4 mm, banana connector, IEC)
- Veterinary clip electrodes (set of 5, match Ø 3-4 mm ECG cable)
- 1 Paper roll
- Rechargeable lithium battery (2,200 mAh)
- Manual: GB, IT - on request FR, ES, DE

33306

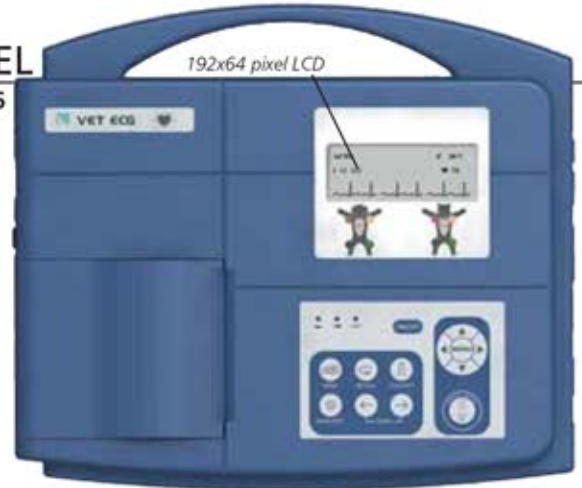

TECHNICAL SPECIFICATIONS

	33305	33306
Lead	One lead	standard 12 lead
Acquisition mode	One lead	12 leads simultaneously
Frequency response	0.05 Hz ~ 150 Hz	
Sensitivity	2.5, 5, 10, 20 (mm/mV)	
Input impedance	≥ 50 MΩ (10 Hz)	
Filter	EMG Filter 35 Hz (-3dB) AC/DFT Filter 50/60Hz (-20dB)	EMG Filter 25/35/45Hz / OFF DFT Filter 0.05/0.15/0.25/ 0.32/0.5/0.67 Hz Low pass Filter 150/100/75 Hz AC Filter on/off
Recording mode	Auto/Manual	Auto/Manual/Rhythm/OFF/USBPRT
Safety standard	IEC I/CF	
Power supply	AC: 100-115 V, 220-240 V, 50/60 Hz Built-in rechargeable Li-ion battery: voltage 14.8 V More than 6.5 hrs, continuously operation under battery supply	
Thermal paper	50 mm x30 m	80 mm x20 m
Paper speed	25/50 mm/s (± 3%)	5/6.25/10/12.5/25/50 mm/s (± 3%)
Size	300x260x75 mm	
Weight	2.3 kg (with battery)	2.5 kg (with battery)
Display	192x64 pixel LCD	
External input/output	Input: ≥100 kΩ; Sensitivity: 10 mm/V ± 5% output: ≤100 kΩ; Sensitivity: 1 mm/V ± 5%	
Communication interface	RS232	Ethernet, RS232, USB

BM3 AND BM5 PORTABLE MULTIPARAMETER VET MONITORS



- 33719 BM3 VET MONITOR - 7" TFT display
- 33779 BM5 VET MONITOR - 10.4" TFT display
- Versatile, portable, lightweight, BM monitors are designed to be used in veterinary environment.
- Compact design and handle make it easy to move.
- Colour monitor displays all vital signs in different colours for easy recognition.
- A built in printer offers hard copy documentation of all measured values.
- Alarms and settings are easily adjustable.
- See all specifications and accessories at page 290, 293.
- 33772 RECTAL TEMPERATURE SENSOR - 2.75 m cable
- 33741 EXACON RECTAL TEMPERATURE SENSOR - 2.75 m cable

ECG+SpO₂+NIBP
+RESP+TEMPERATURE
+2IBP (only 33779)

VETERINARY DOPPLER

- 80600 GIMA VET DOPPLER - FIXED 8 MHz probe
- New doppler for detecting blood flow in small peripheral vessels with its unique 8 MHz probe ideal for veterinary practitioners for routine blood pressure measurement on pets. Flow signals are easily located using the lightweight narrow beam transducer while internal signal processing minimizes noise artefacts.

TECHNICAL SPECIFICATIONS

Ultrasound	Power supply
Frequency: 8 MHz continuous wave	Battery 9V Alkaline (not included)
Transducer: 2 crystal narrow beam	Expected battery life: >9 hours
Output power: <15 mW/cm ² SATA	Output
Audio Response: 300 Hz - 4 kHz	Headset: Audio output for optional headset (not included)
Unit Controls	Material: ABS / Noryl
Keys: 1 key (for unit on/off)	Size: 150x75 mm
Controls: rotary volume	Weight: 299 g (with transducer)
Indicators: yellow battery low LED	Classification: Class I Type B - IEC 60601-1

TOP QUALITY:
MADE IN UK
3 YEARS
WARRANTY

80600



CHISON ECO1 AND ECO3EXP. VET DIGITAL ULTRASOUND SYSTEMS

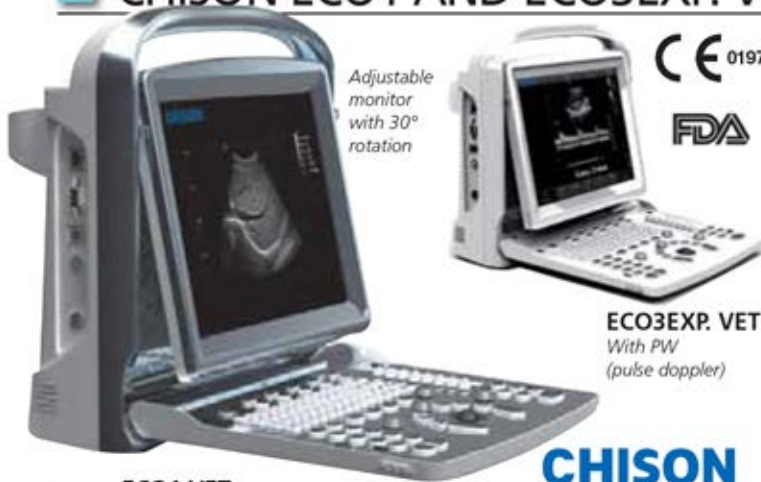

ECO1 VET

ECO3EXP. VET
With PW
(pulse doppler)

CHISON
Value Beyond Imaging

STANDARD PACKAGE	ECO1	ECO3EXP.	ECO5
12" high resolution LED monitor - B&W	•	•	•
12" high resolution LED monitor - colour			•
8G memory card			•
Hot Key	•	•	•
PC printer connection	•	•	•
3 USB port	•	•	•
1 ethernet port	•	•	•
1 video out port, 1 VGA out port	•	•	•
1 footswitch port	•	•	•
Full screen display	•	•	•
2 hours rechargeable lithium-ion battery	optional	•	•
Power adaptor	•	•	•
Standard software package	•	•	•
Easy View image archive system	•	•	•
THI	•	•	•
PW (doppler function to detect blood flow speed)	•	•	•

TECHNICAL SPECIFICATIONS
 Dimension and weight: 33.5x15.5x35 cm (13.2"x6.1"x13.8"); 6 kg
 Display: 12" LED, high resolution 1,024x768
 Power: AC 100-240 V - 50/60 Hz
 rechargeable lithium-ion battery (ECO1 option, ECO3EXP. standard)

	LANGUAGE - switchable by user								
	GB	IT	FR	ES	DE	CZ	TR	CN	RU
Software	•	•	•	•	•	•	•	•	•
User manual	•	•	•	•	•	•	•	•	•

*On request

- 33994 CHISON ECO1 VET with 1 probe connector without probe
- 33995 CHISON ECO3EXP. VET with 2 probe connectors without probe

- ultra-compact and ultra-light weight, easy to carry
- latest LED screen technology, super bright images allow to easily view scan even outdoor.
- ergonomic monitor design, 30 degree rotation, adjustable.
- ultra-long battery life up to 2 hours, for outdoor scanning
- one-key to enlarge image to full screen, easy to view from distance
- streamlined workflow, easy to operate, 6-one-key to finish the cycle of diagnosis.

Display modes and imaging processing

B, B/B, 4B, M, B/M, PW (ECO3EXP. only) multi-frequency imaging

- Imaging processing**
- compound Imaging
 - I-image intelligent image optimization
 - THI (Tissue Harmonic Imaging)
 - SRA (Speckle Reduction Algorithm)
 - full digital beam-former
 - full screen display
 - trapezoidal
 - automatic PW trace (ECO3EXP. only)
 - Chroma
 - AIO (Automatic Image Optimization)

User interface

- fold-up control panel and alphanumeric keyboard
- back-lit keyboard for good visibility in dark room
- interactive back-lighting
- indicator lights identify activated keys
- 8 TGC slides for easy adjustment
- short cut knob for quick adjustment (hot key user- defined)
- neat and clear keyboard layout, doctor can remember easily
- user defined preset

Streamlined workflow, one key to:

- select desired application with automatic preset
- optimize the image automatically (AIO)
- save still image and CINE loop
- print to PC printer* (laser or inkjet) or video printer
- Make report
- Measure

*See list of compatible printers on our website

EASYVIEW™ Archive system

- image archive on hard disk and USB mobile storage
- 3 USB ports
- multiple image formats: BMP, JPG, DCM, CIN, AVI
- cine review: auto, manual (auto review segment can be set for 2D, M, PW (ECO3EXP. only) images)
- cine memory capacity (256 frames/10s)

CHISON ECO5 VET COLOUR DOPPLER DIGITAL ULTRASOUND SYSTEM

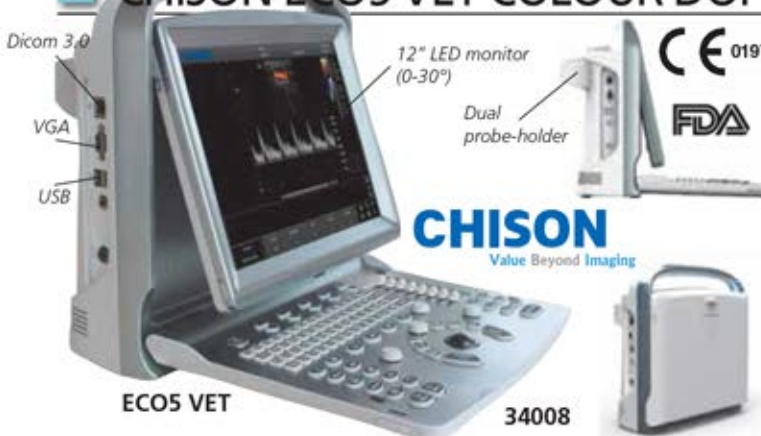

ECO5 VET

34008

CHISON
Value Beyond Imaging

- 34008 CHISON ECO5 VET Colour Doppler 12" high resolution colour LED monitor, 8G high speed memory, 3 USB ports, 2 probe connectors, EASYVIEW™ archive system, without probe

- Imaging processing:**
- MCI (Multiple Compound Imaging)
 - I-image intelligent image optimization
 - THI (Tissue Harmonic Imaging)
 - SRA (Speckle Reduction Algorithm)
 - full digital beam-former
 - trapezoidal
 - automatic PW trace
 - Chroma
 - full screen display model
 - AIO (Automatic Image Optimization)
- Other specifications as ECO3EXP.**

TECHNICAL SPECIFICATIONS
 Dimension and weight: 33.5x15.5x35 cm (13.2"x6.1"x13.8"); 6.5kg
 Display: 12" LED, high-resolution colour 1,024x768
 Power: AC 100-240 V, 50-60 Hz
 Rechargeable lithium-ion battery

PROBES AND ACCESSORIES FOR CHISON ECO SERIES

PROBES ECO1 - 3 - 5			FREQUENCY(MHz)		Main application				
code	CHISON code	Scanning method	Main freq.	Probe band width	CANINE	FELINE	OVINE	EQUINE	BOVINE
33998	C3-A	Convex	3.5	2.5 - 5.0				•	•
33999	L7M-A	Linear*	7.5	5.3 - 10.0	•	•	•	•	•
33871	L7S-A	Linear**	9.0	5.3 - 11.0	•	•	•	•	•
34000	L7V-A	Trans-rectal	7.5	5.3 - 10.0			•	•	•
33997	MC6-A	Micro-convex	6.0	4.5 - 8.0	•	•			
33874	MC3-A	Micro-convex	3.0	2.5 - 5.0	•	•	•	•	•

*With 40 mm footprint, general linear probe

**With 30 mm footprint for superficial tissue exams with higher resolution

code	ECO SERIES ACCESSORIES
33869	Rechargeable lithium-ion battery BT-2500 (2.5 hours)
33867	ECO trolley TR-9000
33868	Carrying case
33866	Needle guided brackets - specify for which probe (available for 33998-9, 33874 only)
PRINTERS	
33968	SONY UP-X898 MD B&W printer (for ECO1 and ECO3EXP.)
33993	SONY UP25MD colour printer(for ECO5)



HANDHELD VET PULSE OXIMETER



34346

• 34343 OXY 100 VET PULSE OXIMETER

OXY 100 Handheld Pulse Oximeter can measure oxygen saturation (SpO₂) and Pulse Rate (PR) by placing the sensor on a certain part of the animal, such as tongue, ear, leg or tail. It also provides plethysmogram, bar-graph and Perfusion Index display.

- lightweight, small and easy to handle
- data storage with trend review
- two options for measurement on: thin tissue: such as tongue, ear, thick tissue: such as leg, tail.

- up to 384 hours of data memory (with 1/2/4/8 sec. recording interval)
- audible & visual alert for over-limits (limits are adjustable). Tested for cats and dogs. Not suitable for big or very small animals. See technical specifications page 297

Oximeter is supplied with universal "Y" type SpO₂ probe and three types of adapters: big clip, small clip and rubber wrapper. Each of these adapters allows a different measuring respectively on tongue, ear, leg or tail.

- 34346 UNIVERSAL "Y" type SpO₂ probe - spare includes 3 probe adapters (big clip, small clip, rubber wrapper).

VET ELECTRONIC SPHYGMOMANOMETER AND SpO₂



• 80550 VET ELECTRONIC SPHYGMOMANOMETER

Electronic sphygmomanometer with fully automatic measurement of animals blood pressure and large, high definition colour LCD display.

- data storage for up to 100 groups of data with date and time
- automatic one-touch operation
- alarm function with possibility to set alarm limits
- dual scales: kPa and mmHg
- selection of five cuff sizes: small, small/medium, medium, large, X-large
- automatic power off

Supplied with medium cuff (10-19 cm) and multilanguage manual (GB, FR, IT, ES, PT)

30557



TECHNICAL SPECIFICATIONS SPO₂

SpO₂ range: 0-100% (resolution 1%)
 SpO₂ accuracy: 70%-100%: ± 2%
 PR range: 30bpm-250bpm, (resolution 1bpm)
 PR accuracy: ± 2bpm or ± 2% (select larger)

code	ACCESSORIES
80556	Power adaptor
80557	SpO ₂ probe - optional
80558	Extension cable for 80557

code	CUFFS	Size	Suitable for
80551	Small	6-11 cm	Cats, baby dogs,...
80552	Small/medium	10-19 cm	Small dogs, fox, sheep...
80553	Medium	18-26 cm	Baby horses, baby pigs, big dogs, deers
80554	Large	22-32 cm	Horses, pigs, puma, baby bears, lions
80555	X-Large	33-47 cm	Bears, lions, tigers

TECHNICAL SPECIFICATIONS SPHYGMO

Measurement method: oscillometric
 Measurement range: 0-38.67 kPa (0-290 mmHg)
 Resolution: 1 mmHg
 Accuracy: static pressure: ±0.4 kPa (±3 mmHg)
 Inflation - Deflation: automatic inflation - automatic multistep deflation
 Display: 2.8" colour LCD screen
 Power: four "AA" batteries or optional power adaptor
 Safety: class II device type BF applied part
 Dimension - Weight: 130x110x80 mm - 300 g

VET STETHOSCOPE DIGITAL THERMOMETERS

• 32545 REGALITE VET - black

Top quality single head stethoscope. Patented multi-frequency "ring-oraised™" diaphragm system. Chromed plated chestpiece with "SUPERFLEX" inner spring binaural and 1 piece moulded PVC, latex free, tubing 90 cm long. Supplied in deluxe box, with spare soft eartips and one spare diaphragm.

90 CM LONG Y TUBE

32545



• 25588 VET RECTAL THERMOMETER

25588

Designed to be ergonomically correct for animals. Setting for pets, pigs, cattle and other animals.

• 80450 VET DIGITAL THERMOMETER - flexible tip

LCD size 15x7 mm

• 80455 THERMOFOCUS® ANIMAL NON CONTACT THERMOMETER

Infrared non contact thermometer allows to take pet's body temperature at distance from its eye. MQCS function allows manual calibration in case veterinary is moving to different environments. Thermofocus® animal is suitable for all animals and is multipurpose (can take temperature of liquid, food, ...). Made in Italy.

TECHNICAL SPECIFICATIONS

	25588	80450	80455
Measurement range:	32-44°C	32-42.9°C	32-43.5°C
Accuracy:	± 0.1°C (35-39°C)	± 0.1°C	± 0.2°C (36-39°C)
Battery life is approx.	5,000 readouts	10,000 readouts	10,000 readouts
Dimension:	190x110x35 mm	138x21x10 mm	165x40x22 mm
Battery:	2x1.5V AAA	1.5V LR41	4x1.5 V AAA
Measurement time:		60 sec.	instantaneous

80455



Sold in blister

MD SCOPE VET VIDEO OTOSCOPE



MD SCOPE VET VIDEO OTOSCOPE

Instant View
A clear and sharp image can be acquired and displayed instantly on a built-in screen. Just press a single button and wait for 3 seconds.

Real Time Interaction
The medical image can be captured and displayed simultaneously on TV monitor or downloaded to Mac/PC system.

Electronic medical record
A medical image is automatically generated to support most of the stand-alone health information system. Probes and accessories at page 208.



- 32164 VET MD SCOPE PACK 32175
- 3 cameras
- 3 camera probes 75/150/300 mm
- image dogle
- cable set
- 2 AA alkaline batteries
- 32175 CRADLE

TECHNICAL SPECIFICATIONS

2.4" colour LCD display
Video out port
Size/weight: 8x20 cm (2.5"x8") - 218 g
Battery lifespan: 4 hours

HEINE VET OTO AND OPHTHALMO



80500

- 80500 BETA OTOSCOPE SET 2.5 V - G-112.10.118
Set complete with slit illumination head, 1 set long closed metal specula (57x4,65x6,90x7 mm), 1 spare bulb, hard case.
- 80501 BETA 200 VET F.O. XHL OTO-OPHTHALMO SET 2.5 V - G-151.10.118
Set complete with:
- Beta 200 ophthalmoscope, Beta 200 vet otoscope
- 3 reusable Sanalons vet specula 61x Ø 4/6/9 mm
- 1 spare bulb for each instrument
- zipper case
- 31772 HEINE 077 OTOSCOPE BULB 2.5 V - spare
- 31781 HEINE 069 OPHTHALMOSCOPE BULB 2.5 V - spare

F.O. XHL XENON HALOGEN TECHNOLOGY



80501

VET OTOSCOPES, OPHTHALMO AND DIAGNOSTIC SETS



31442

Open otoscope head is supplied with codes 31422, 31424, 31425

31429

- 31442 PARKER VETERINARY OTOSCOPE
Includes: kit of 3 reusable plastic cannulas (31447)



31424

- 31424 XENON HALOGEN DIAGNOSTIC SET
Includes: xenon halogen open otoscope head+handle, xenon-halogen ophthalmoscope head, kit of 5 reusable plastic cannulas (31451), metal tongue depressor holder illuminator, nasal specula
Rechargeable battery handle 2.5V
All sets have 2.5V handle for use with 2xC batteries or rechargeable batteries (34479)



31422

- 31422 XENON HALOGEN OTOSCOPE SET
Includes: xenon-halogen open otoscope head+handle, kit of 5 reusable plastic cannulas (31451), kit of 3 reusable plastic cannulas (31447)



31425

- 31425 XENON HALOGEN DIAGNOSTIC SET metal cannulas
Includes: xenon-halogen open otoscope head+handle, xenon-halogen ophthalmoscope head, kit of 3 reusable metal cannulas + 2 metal specula (31453)



31447



31453



31451



Easy adjustable with finger clip

31454

code	VETERINARY SETS AND ACCESSORIES
31451	Kit of 5 reusable plastic cannulas (Ø 2.5, 3.5, 4.5, 5.5, 9 mm)
31447	Kit of 3 reusable plastic cannulas (Ø 4, 5, 7 mm)
31453	Kit of 3 reusable metal cannulas (Ø 4, 5, 6 mm) + 2 slotted metal specula (Ø 7.5, 9.4 mm)
31454	Nasal specula
31478	Xenon halogen otoscope bulb 2.5 V
31479	Xenon halogen ophthalmoscope bulb 2.5 V
31449	Standard otoscope bulb vacuum 2.5 V for 31442
31542	Charging station
34479	Rechargeable NiMH battery 2.5 V / 3000 mAh
31429	Swivel lens 2X for Vet oto sets 31422, 31424, 31425

HEAD AND BRAIN



Life size

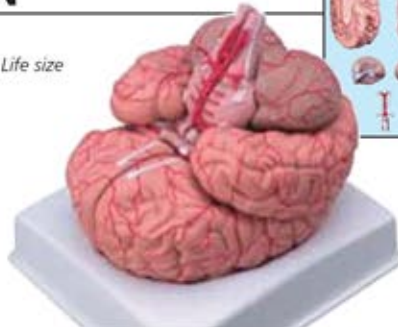

Can be divided into 9 parts showing the temporal and occipital lobes, the frontal and parietal lobes, the cerebellum, the brain stem and basiliary artery

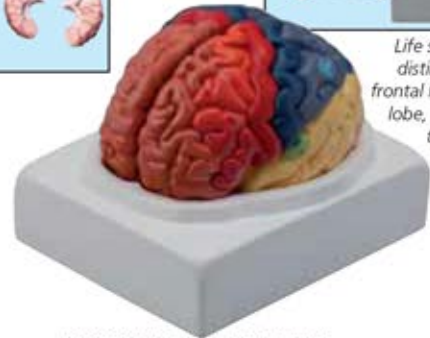
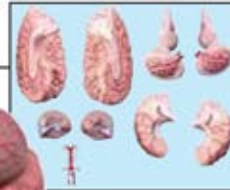

Life size brain with distinct colour for: frontal lobe, parietal lobe, occipital lobe, temporal lobe, motor cortex, somatosensory cortex, limbic cortex, cerebellum, brain stem

• **40010 HEAD DISSECTION - life size**
Size: 18x25x23 cm - 140 g - 4 parts - 1X

• **40020 BRAIN WITH ARTERIES**
Size: 16x18x16 cm - 1 kg - 9 parts - 1X

• **40021 REGIONAL BRAIN**
Size: 20x17x15 cm - 1.3 kg - 2 parts

SENSE ORGANS: EYE AND EAR

These models show the external, middle and inner ear. The eardrum with malleus, incus and stapes are removable. Also cochlea and labyrinth with vestibular and cochlear nerves and 2 bones sections (40042 only) that define the middle and inner ear are removable.



40041-40042

code	EAR SIZES	Kg	Parts	Mag
40041	33x23x21 cm	1	3	3X
40042	33x23x21 cm	2	5	3X

Cornea, iris, lens and vitreous body can be removed.

40030
Disassembled



40030
Assembled

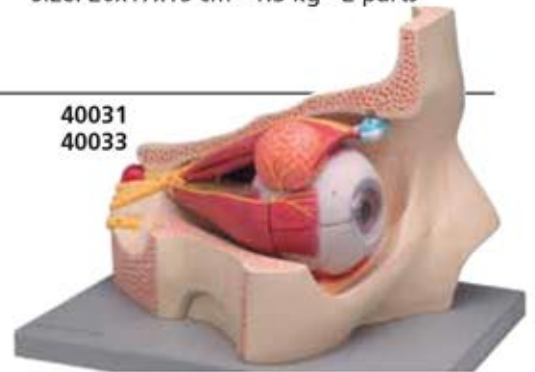

40031
40033

Models show the eye ball with optic nerves and muscles in its natural position in the bony orbit

code	EYE WITH ORBIT SIZES	Kg	Parts	Mag
40030	15x17x27 cm	0.9	6	6X
40031	42x30x31 cm	3.2	4	5X
40033	42x30x31 cm	3.4	11	5X

RESPIRATORY SYSTEM: NASAL CAVITY, LARYNX



3x life size, the model shows a medial section of the nasal cavity. The nasal septum and part of the olfactory epithelium are removable to show deep internal structures.

• **40056 NASAL CAVITY**
Size: 15x20x30 cm - 1 kg - 3 parts - 3X
Mounted on base with stand.



A life size reproduction of the complete human respiratory system. It is composed of 7 parts showing the larynx (dissected along the sagittal plane), the lungs (dissected along the frontal plane) and a 2-part heart.

• **40050 RESPIRATORY SYSTEM**
Size: 26x40x12 cm - 1.3 kg - 7 parts life size



• **40058 LARYNX**
Size: 18x11x8 cm - 450 g - 5 parts - 2X
Mounted on a base with stand.

Longitudinally sectioned to reveal inner details of internal structure including hyoid bone, vessels, ligaments, cartilages, muscles, nerves and thyroid gland

DIGESTIVE SYSTEMS: LIVER, PANCREAS, STOMACH

This model, 15x life size, shows the liver and gallbladder in open section with the complex network of vessels and bile ducts, displayed in different colours to clarity and ease of examination.

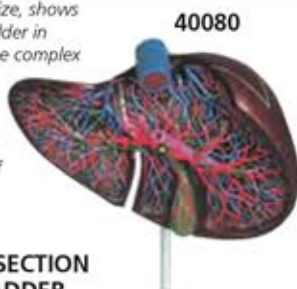

40080

• **40080 LIVER SECTION WITH GALLBLADDER**
Size: 28x27x14 cm - 880 g - 1 part - 1.5X
Mounted on a base with stand.

Accurate representation of the pancreas, spleen and duodenum. The pancreas is open to show the entire pancreatic duct. The duodenum is partially dissected to expose its internal structure.

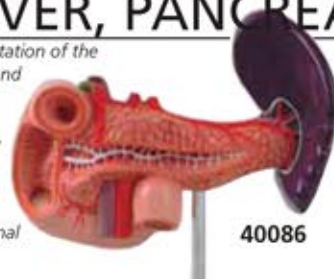

40086

• **40086 PANCREAS, DUODENUM AND SPLEEN**
Size: 16x15x23 cm - 350 g - 1 part - 1X
Mounted on a base with stand.

Can be opened to show the internal structure of the stomach, including the mucosa, the pylorus, and a section of the gastric wall. Superficial dissection exposes the longitudinal, circular and oblique muscle layers, with nerves and vascular structures

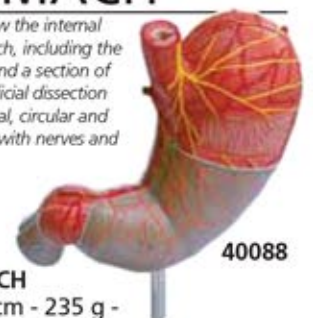

40088

• **40088 STOMACH**
Size: 16x14.5x5 cm - 235 g - 2 parts - 1.5X
Mounted on a base with stand.

HEART AND CIRCULATORY SYSTEM

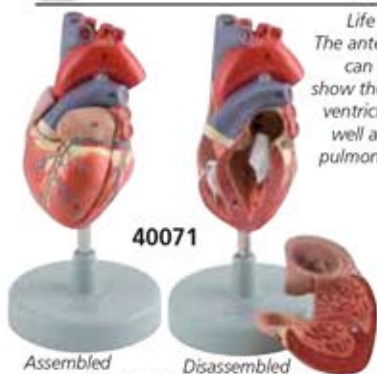

Assembled Disassembled

40071
Enlarged 2000 times, this model shows the various types of blood cells, including red blood cells, white blood cells (lymphocytes, monocytes, neutrophils, eosinophils and basophils) and blood platelets.

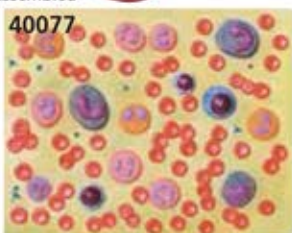

40077

Life size in 2 parts. The anterior heart wall can be removed to show the left and right ventricles and atria as well as the tricuspid, pulmonary, mitral and aortic valves.

Show internal structures including the cardiac valves and the comparative morphology of the right and left ventricles. The right atrium is also removable.



40072



A general view of the human circulation. It includes the heart (2 parts), lungs, liver, spleen, kidneys and relevant connections with the pulmonary and systematic circulatory pathways.

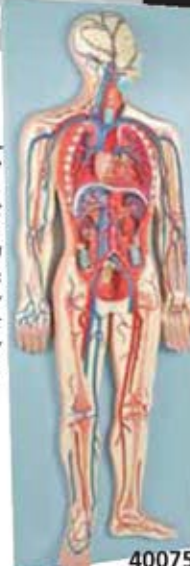

40075

code	HEART AND CIRCULATORY SYSTEM	Size cm	Weight kg	Parts	Magnif.
40071	HEART - mounted on base	11x7x10	0.23	2	1X
40072	GIANT HEART - mounted on base	24x25x28	3.5	4	3X
40077	BLOOD CELLS - mounted on board	58x38x7	1.0	1	2000X
40075	CIRCULATORY SYSTEM - mounted on board	90x32x11	2.3	2	0.5X

URINARY SYSTEM: MALE BLADDER, KIDNEY

40090 MALE URINARY BLADDER WITH PROSTATE

Size: 27x20x15 cm - 1,2 kg - 2 parts - 3X

This model, enlarged 3 times, shows the male urinary bladder with the prostate gland surrounding the urethra. The model is dissected medially to expose both internal and external structures of the bladder and prostate, including the ureteric and urethral orifices, ductus deferens, seminal gland, ejaculatory duct.



40090

40094 KIDNEY WITH ADRENAL GLAND+RENAL CORPUSCLE

Size: 40x15x8 cm - 1,2 kg - 1 part - 3X

This model shows a frontal section of the human kidney enlarged 3 times. The kidney is shown with the renal capsule. Additional structures include: the cortex, medulla, pyramids with papillae, partially dissected renal pelvis, renal calices, ureter, blood vessels, suprarenal gland with cortex and medulla. A schematic representation of the renal corpuscle with the system of collecting tubules is included.



40094

PELVIS - FEMALE AND MALE

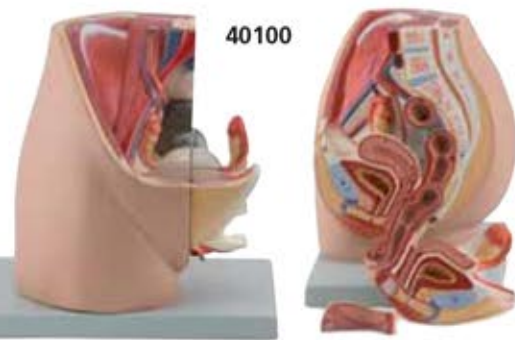

40100

This life size model, composed of 3 parts, shows an open dissection through the median sagittal section of the pelvis. Internal structures of the female urogenital system are portrayed in great detail. Removable parts include half of the female reproductive system with the uterus opened to reveal medial and transverse sectional views.

This life size model, composed of 4 parts, presents an open view through a median sagittal section of the pelvis. Internal structures of the male urogenital system are represented in fine detail. The removable parts include a half penis divided into medial and transverse sections, and half of the male reproductive system with an open dissection of a testis showing details of the internal structure.

40105

code	PELVIS size cm	Sex	Kg	Parts	Mag
40100	30x20x27	fem	1.7	3	1X
40105	30x20x27	male	1.7	4	1X

PREGNANCY PELVIS

This life size model depicts the female human pelvis in median section with a fetus in the 40th week of pregnancy. The fetus is in the normal position prior to birth, showing the anatomical relationship between various structures of the maternal pelvis and the fetus. Fetus is detachable for closer examination.

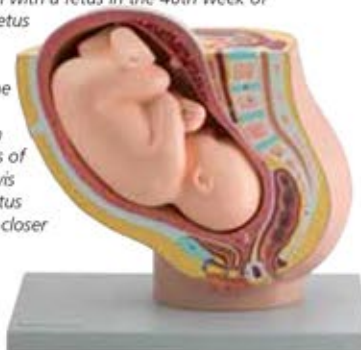

40110 PREGNANCY PELVIS WITH MATURE FETUS

Size: 40x26x34 cm - 3.3 kg - 2 part - 1X

SKIN

40061 SKIN MODEL - 30X

Size: 20x15x15.5 cm - 1.2 kg
Mounted on base

All the skin layers can be easily identified and the main structures such as hair follicle, sensitive corpuscles, sebaceous and sweat glands, are numbered and referred on the accompanying k-card

40061

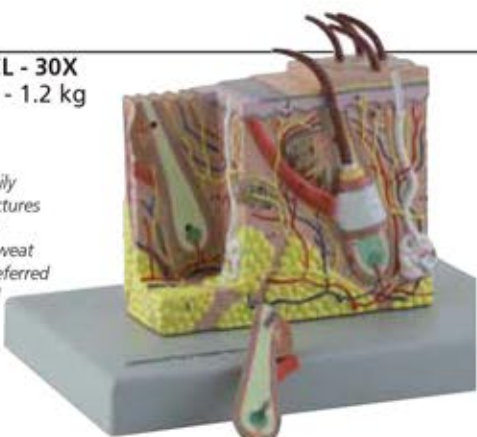

40060 SKIN MODEL - 70X

Size: 25x18x28 cm - 1.5 kg
2 parts - 70X
Mounted on base

Anatomical structures are shown in details including the hair follicles, sebaceous glands, sweat glands, erector muscles, Pacinian corpuscles, nerves and blood vessels. The different layers of the skin are clearly defined. A portion of a hair shaft can be removed to show internal details.

40060

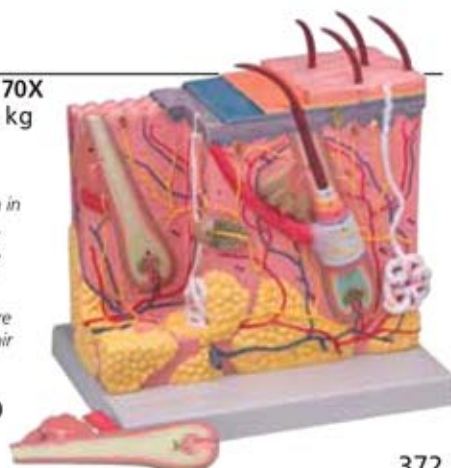

HUMAN TORSOS WITH CD AND MUSCULAR FIGURES

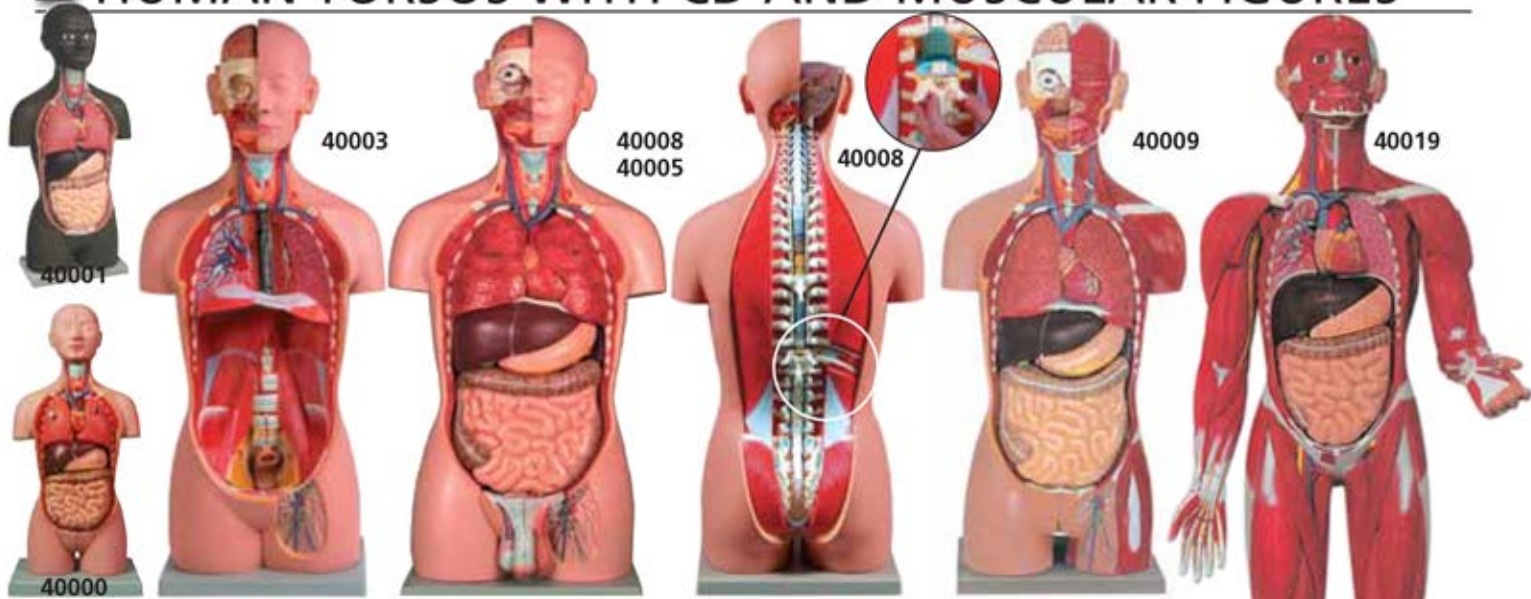

code	HUMAN TORSOS *SUPPLIED WITH CD ROM GUIDE	Size	Weight	Parts
40000	MINI TORSO	20x15xh45 cm	2.1 kg	16
40001	MINI TORSO - african	20x15xh45 cm	2.1 kg	16
40003	TORSO UNI SEX *	23x33xh90 cm	9 kg	16
40005	TORSO DUAL SEX*	23x33xh90 cm	9.3 kg	25
40008	TORSO DUAL SEX OPENBACK*	23x33xh90 cm	9.3 kg	27
40009	MUSCULAR TORSO DUAL SEX OPENBACK*	23x33xh90 cm	10 kg	28
40019	MUSCULAR FIGURE	30x33xh87 cm	5.3 kg	30



This CD-ROM Guide greatly extends the educational value of the anatomical torsos by identifying hundreds of structures that are not included on the printed key. High-resolution digital images of torso components show the finest anatomical details of all body systems from various angles.

Some of the detachable parts of human torsos (40005-8-9):

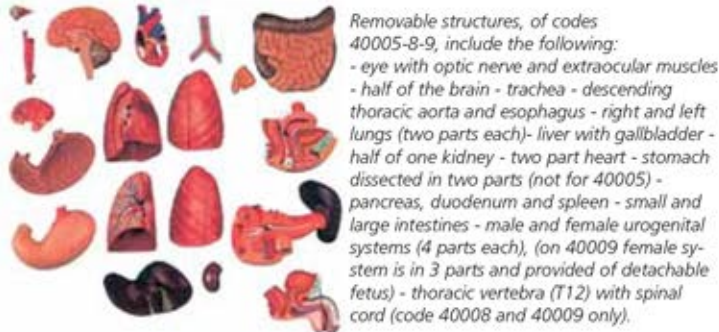

Removable structures, of codes 40005-8-9, include the following:
 - eye with optic nerve and extraocular muscles
 - half of the brain - trachea - descending thoracic aorta and esophagus - right and left lungs (two parts each) - liver with gallbladder - half of one kidney - two part heart - stomach dissected in two parts (not for 40005) - pancreas, duodenum and spleen - small and large intestines - male and female urogenital systems (4 parts each), (on 40009 female system is in 3 parts and provided of detachable fetus) - thoracic vertebra (T12) with spinal cord (code 40008 and 40009 only).

Detachables parts of human muscular figure 40019:



HEAD MUSCULATURE

• 40015 HEAD/NECK MUSCULATURE

Size: 37x23x46 cm
 - 3.1 kg - 1 part - life size

Superficial and deep musculature are well represented as are the pathways of the subclavian and carotid arteries

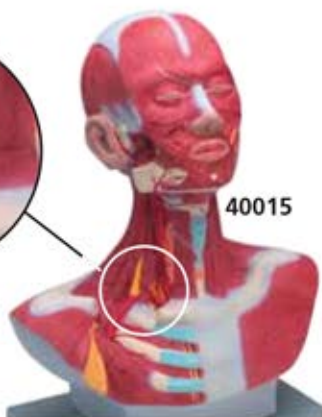

40015

MUSCLES: SHOULDER, ARM, LEG

• 40016 SHOULDER MUSCLE

Size: 23x19x11 cm - 435 g
 1 part - 1X

Mounted on a base with stand



40016

This model illustrates in great details the muscles, ligaments and bones of the shoulder. Through different muscles section it is possible to observe the deep musculature to the bone.

• 40017 ARM MUSCLE

Size: 74x20x12 cm - 1.9 kg
 - 7 parts

Mounted on a base with stand



40017

This 7-part life size model shows, in great detail, the anatomical structure of the arm, complete with superficial and deeper muscles, vascular structures, nerves and ligaments. The hand and the shoulder are also well represented. The following parts are removable:
 - deltoid muscle
 - biceps muscle
 - triceps muscle
 - long palmar muscle with radial flexor muscle of wrist
 - brachioradial muscle
 - radial extensor muscle of wrist
 - palmar aponeurosis

• 40018 LEG MUSCLE

Size: 110x19x14.5 cm - 5.1 kg
 13 parts

Mounted on a base with stand

This 13-part model shows, in great detail, the anatomical structure of the leg, complete with superficial and deeper muscles, vascular structures, nerves and ligaments.

The following parts are removable:

- sartorius
- long head of biceps
- gluteus maximus
- soleus
- gastrocnemius
- gluteus medius
- gracilis
- semitendinosus and semimembranosus
- rectus femoris
- extensor digitorum longus
- sole of foot
- tensor fasciae latae

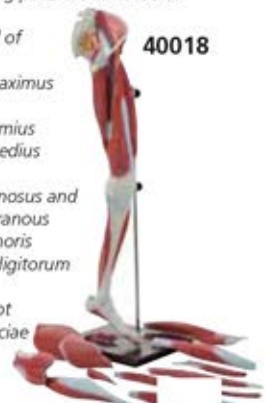

40018

SKELETONS

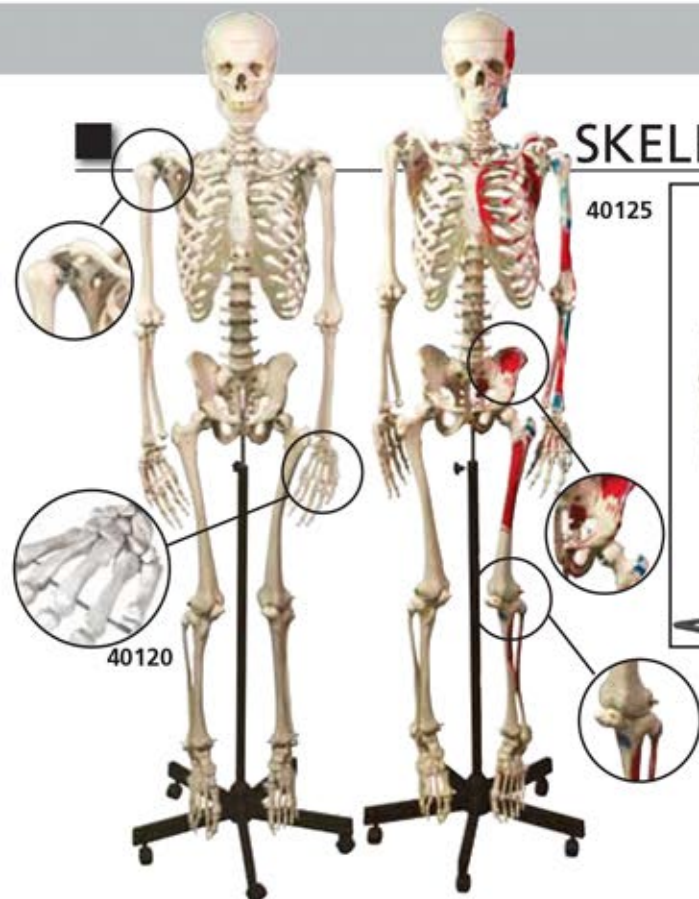

40115 MINI SKELETON

Height: 80 cm Weight: 1.5 kg. This 1/2 life size model shows the anatomy of the human skeleton in high detail. The skull can be disassembled into 3 parts: skullcap, base of skull and mandible. All the main joints are articulated. Arms and legs can be removed easily. Mounted on a stand for hanging.

40120 HUMAN SKELETON

Height: 170 cm. Weight: approx 10 kg. This model is a replica of a life size human skeleton and shows all the skeleton parts in high detail. It's hand-assembled to provide intricate details and long-lasting durability. The main joints are articulated; the upper and lower limbs can be removed easily. The following parts are detachable: Calvarium, Skull, Jaw, Arms, Legs. Supplied with 5-caster roller stand.

40125 MUSCULAR HUMAN SKELETON

Same as code 40120 but with the left side of the skeleton showing the point of origin (red) and the point of insertion (blue) of the muscles.

VERTEBRAL COLUMNS

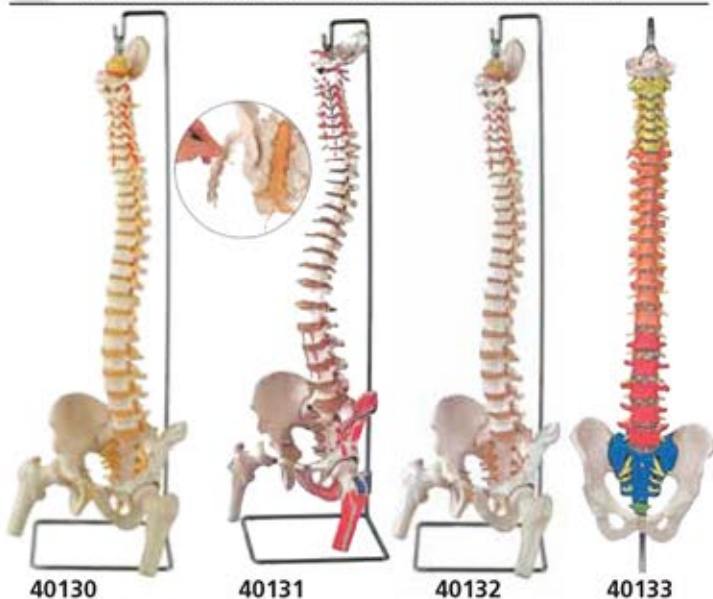

FLEXIBLE VERTEBRAL COLUMNS

Fully flexible life size vertebral columns consisting of the occipital plate, cervical, thoracic and lumbar vertebrae, sacrum, coccyx, complete pelvis with symphysis, removable femur heads (only 40130,31,32).

All models also feature representation of the vertebral arteries, spinal nerve branches, and a prolapsed L3-L4 intervertebral disc.

On 40131 the left side of the skeleton shows the points of origin (red) and the point of insertion (blue) of the muscles. On 40131 and 40132 the sacral crest and coccyx are removable to show the sacral section of the spinal cord and associated nerve branches.

On 40133 the various regions of the spinal column are colour coded for easy identification.

code	FLEXIBLE VERTEBRAL COLUMNS	Size cm	Weight	Magnif.
40130	VERTEBRAL COLUMN with femur heads	95x20x20	3 kg	1X
40131	VERTEBRAL COL with femur + muscle	95x20x20	3 kg	1X
40132	VERTEBRAL COL with femur + open sacrum	95x20x20	3 kg	1X
40133	SPINAL COL with colour coded regions	98x23x23	970 g	1X

KNEE AND SHOULDER

40140 SHOULDER JOINT

Size: 29x12x12cm - 560g - 1 part - 1X
Mounted on stand.

40145 KNEE JOINT

Size: 12x12x31cm - 440g - 1 part - 1X

The life size model represents a functional model of knee joint with lateral ligaments, meniscus and patellar ligament.

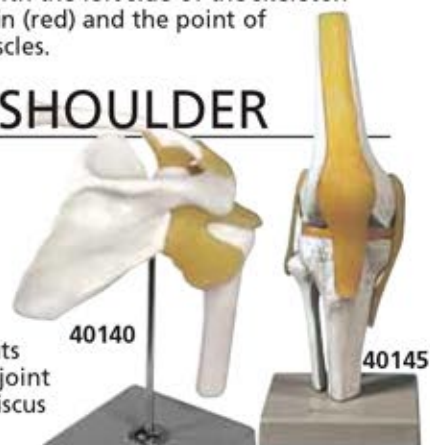

SKELETAL SYSTEM

Advanced osteoporosis model.

Shows 3 vertebrae: one healthy vertebra, one vertebra with pathological changes at first stage, one vertebra with pathological changes at advanced stage.



Cervical spinal column consists of 7 cervical vertebrae with intervertebral discs, occipital plate, cervical nerves, vertebral arteries, spinal cord and brain stem.

Thoracic spinal column consists of 12 thoracic vertebrae with intervertebral discs, thoracic nerves and spinal cord.

Lumbar spinal column with sacral and coccyx bones. It consists of 5 lumbar vertebrae with intervertebral discs, lumbar nerves and spinal cord. The sacral crest and coccyx are removable.

3 lumbar vertebrae with hernia and prolapsed intervertebral disc. Shows 3 lumbar vertebrae with spinal nerves, dura mater and 2 intervertebral discs affected by lateral and medial hernia.

code	SKELETAL SYSTEM	Size cm	Weight	Magnif.
40136	CERVICAL SPINAL COLUMN	12x12x22	350 g	1X
40137	THORACIC SPINAL COLUMN	12x12x40	600 g	1X
40138	LUMBAR SPINAL COLUMN	12x12x36	800 g	1X
40180	HERNIA PATHOLOGY	16.5x12x26	300 g	1X
40185	ADVANCED OSTEOPOROSIS	12x12x15	200 g	1X

HUMAN SKULLS - 3 PARTS



40160



40161



40162



40163

Numbered skull (40161)

Significant structures are numerated

Coloured skull (40162)

All the bones are depicted in different colours, making this model a useful tool to study the correct position and relationship of all the structures.

Muscular skull (40163)

The left side of the skull shows the points of origin (red) and the point of insertion (blue) of the muscles.

MINI SKULL (40165) 1/2 adult natural size

It depicts all structural details of the skull. It can be disassembled into skullcap and base of skull.

Articulated mandible.

Life size human skull reproduction with all details, made in PVC. Removable skull cap and articulated mandible.



40165

code	HUMAN SKULLS	Size cm	Weight g	Magnif.
40160	HUMAN SKULL	22x14x16	950	1X
40161	HUMAN SKULL - numerated	22x14x16	950	1X
40162	HUMAN SKULL - coloured	19.5x17x21.5	950	1X
40163	HUMAN SKULL - muscular	18x17x21	875	1X
40165	MINI SKULL	11x11x16.5	150	0.5X

DENTAL MODELS

• 40206 DECIDUOUS TEETH

Size: 9x9x10 cm - weight: 85 g. Mounted on base with stand.

This life size model shows the upper and lower jaw of a 5 year old child. The lower jaw is movable to reproduce the natural chew. The model exposes the arrangement of the young teeth.



40206

40205

• 40205 PERMANENT TEETH

Size: 11x11x12 cm - weight: 170 g. Mounted on base with stand.

This life size model shows the upper and lower jaw of an adult. The lower jaw is movable to reproduce the natural chew. The model exposes the complete set of permanent teeth with roots and nerves fibres.



• 40210 LOWER JAW

Size: 35x18x31 cm - weight: 1130 g
Mounted on base with stand.

This 3X life size model is divisible into 6 parts to show all the characteristics of an adult half mandible. A portion of the jaw can be removed to show the roots of the teeth and the internal structure of the bone. Canine and molar teeth can be removed and dissected longitudinally to observe the tooth roots, pulp and nerves.



• 40212 DENTAL PATHOLOGY MODEL

Size: 6x4.5x11 cm - weight: approx. 100 g

This 4X life size model shows the process of dental caries in its progressive stages. The tissues forming the tooth (enamel, dentine and pulp) are shown, along with the way in which they are affected by the caries process.



• 40200 ORAL HYGIENE

Size: 12x16x22 cm - weight: 1 kg
Mounted on base.

A 3X life size model useful to teach the correct way to brush teeth. A giant toothbrush is included.



• 40213 SET 3 TEETH: INCISOR, CANINE, MOLAR

Size: 33x33x11 cm - weight: 700 g

5-part model includes representations (10X life size) of human incisor, canine and molar teeth. The canine and molar can be divided into 2 parts each, showing internal features (dentine, enamel, cement and pulp).



• 40214 LOWER MOLAR WITH CARIES

Size: 11x11x19.5 cm - weight: approx. 250 g
Mounted on base with stand.

This 1-piece model is approximately 10X life size; it shows the most important dental pathologies, including dental caries, pulpitis, gingivitis and periapical periodontitis.



• 40211 DENTAL CARIES

Size: 12x6x6 cm - weight: approx. 300 g

This model, composed of 7 parts, is 4X life size. It consists of 3 teeth, seated in their sockets, showing the progressive deterioration of tooth structure by dental caries. The first tooth shows the caries in the enamel. In the second tooth, the caries spreads through the dentine. In the third tooth, the pathology affects the pulp, jeopardizing the vitality of the tooth.

VALUE HUMAN ANATOMY MODELS

HUMAN SKULLS - 3 parts

A detailed reproduction of a life size human skull with all structural details. The mandible is articulated, the skullcap is removable to show internal details. All of the joints, sutures, fissures, foramina and processes are portrayed with utmost accuracy.



• 40155 HUMAN SKULL 1X - 3 parts



• 40156 HUMAN SKULL 1X NUMERATED - 3 parts



• 40157 HUMAN SKULL 1X COLOURED - 3 parts



Giant toothbrush is included

• 40199 ORAL HYGIENE MODEL - 3X

Fully flexible life size vertebral columns consisting of the occipital plate, cervical, thoracic and lumbar vertebrae, sacrum, coccyx, complete pelvis with symphysis, removable femur heads



• 40127 FLEXIBLE VERTEBRAL COLUMN with femur heads



A functional model of knee joint with lateral ligaments, meniscus and patellar ligament.

• 40144 KNEE JOINT

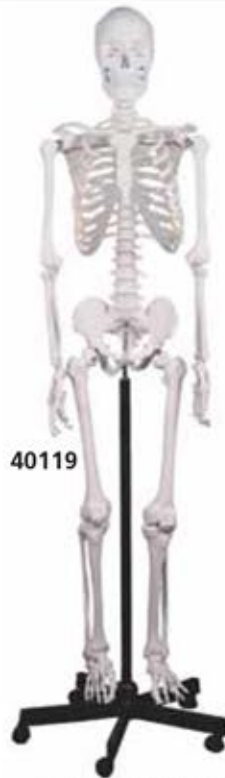

40119



40124

Life size human skeletons show all the skeleton parts in high detail. The main joints are articulated; the upper and lower limbs can be easily removed. The following parts are detachable: Calvarium, Skull, Jaw, Arms, Legs. Supplied with 5-caster roller stand.

Height: 180 cm
Weight: approx 10 kg



40124

• 40119 HUMAN SKELETON

• 40124 HUMAN MUSCULAR SKELETON



• 40139 SHOULDER JOINT



Life size in 2 parts. The anterior heart wall can be removed to show the left and right ventricles and atria as well as the tricuspid, pulmonary, mitral and aortic valves.

• 40069 HEART 1X - 2 parts



• 40070 HEART 3X - 3 parts



40070

Shows internal structures including the cardiac valves and the comparative morphology of the right and left ventricles.



Assembled

• 40028 EYE 6X - 6 parts



40028

Disassembled

Cornea, iris, lens and vitreous body can be removed.



• 40038 EAR 3X - 3 parts

These models show the external, middle and inner ear. The eardrum with malleus, incus and stapes are removable. Also cochlea and labyrinth with vestibular and cochlear nerves and 2 bones sections (40039 only) that define the middle and inner ear are removable.



• 40039 EAR 3X - 5 parts



40039



OFICINA CENTRAL

Calle de Joaquín Turina, 2
1ª planta, Oficina 6
28224. Pozuelo de Alarcón
Madrid. España
T +34 917 342 058
F +34 917 903 734
lomisa@lomisa.com



www.lomisa.es

Nos reservamos el derecho a cambiar las especificaciones técnicas sin previo aviso