



DOMICILIO FISCAL: C/ Punta Umbría, 26 - 28939 Arroyomolinos (MADRID)

Contents

- 01 BIOT002EH**
Electro-hydraulic operating table
- 11 BIOT001E**
Electric operating table
- 17 BIOT003M**
Manual operating table
- 23 BIOT004M**
Manual operating table
- 26 Specialist surgery**
Ophthalmological purpose



DOMICILIO FISCAL: C/ Punta Umbría, 26 - 28939 Arroyomolinos (MADRID)



Sliding Longitudinal shift function

The longitudinal shift could up to 350mm, best effect for compatible with C-arm without the need to repositioning or reverse positioning the table. Easy control on the hand controller or built-in central controller.



Electro-hydraulic system ensure the highly performance
Fast and stable, keep patient safe and offer benefits to surgery

Surgery can be performed in an ergonomic and relaxed
environment, whether seated or standing.

BIOT002EH

Electro-hydraulic operating table

User satisfaction

Highest product safety and quality

New standard of flexible adjustment
Quick and stable movements
Durable and reliable materials, best choice for general surgery



Quick adjust for leg plate swing out



Quick adjust for leg plate up and down, optional gas spring control



Quick adjust for head plate up and down



Opional dual layers radiolucent table platform

BIOT002EH

Electro-hydraulic operating table

Radiolucent

X-ray compatible plate

Thanks to X-ray compatible plate table platform, Our table could well allow for X-rays to be taken while the patient is still in the table.

Optional Double layers platform could be chosen for holding x-ray film.



C-arm available



Memory foam mattress to ensure the comfortable of patient

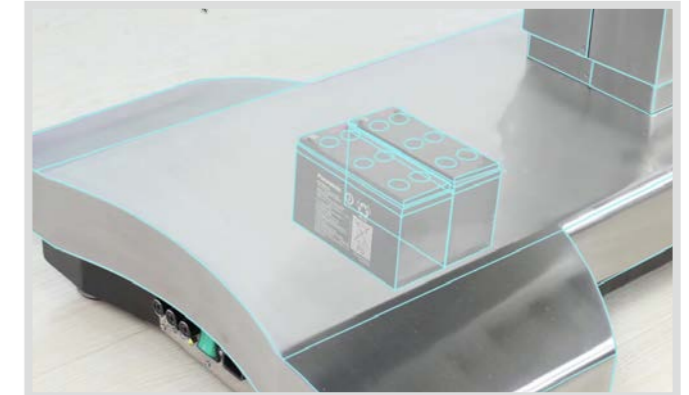

Equip with battery to handle with emergency cases



Flexible castors , for any cases need to transfer the table. When no need to transfer, the foot stand is extremely stable



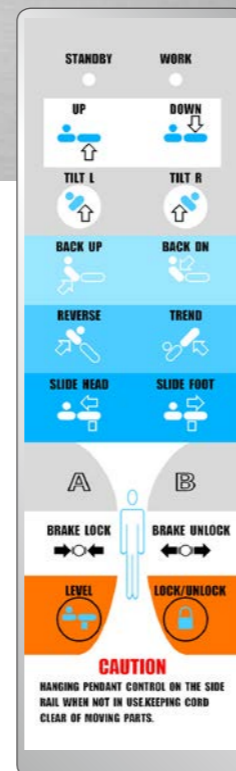

Hand controller

Controls

Perfect touching feeling

The hand controller has clear image for guiding the operation
Built-in central controller, both has one button recovery
Both has manual control panel lock, optional for the auto-lock
Perfect touching feeling and backlit function for dark environment

Positions

Versatile positions for various surgery

High quality eletro-hydraulic system ensures adjust the table into versatile positions fast and easy, patient could have various surgery on this table.



Convenient positioning techniques For multi-purpose adjustment



Movements specifications

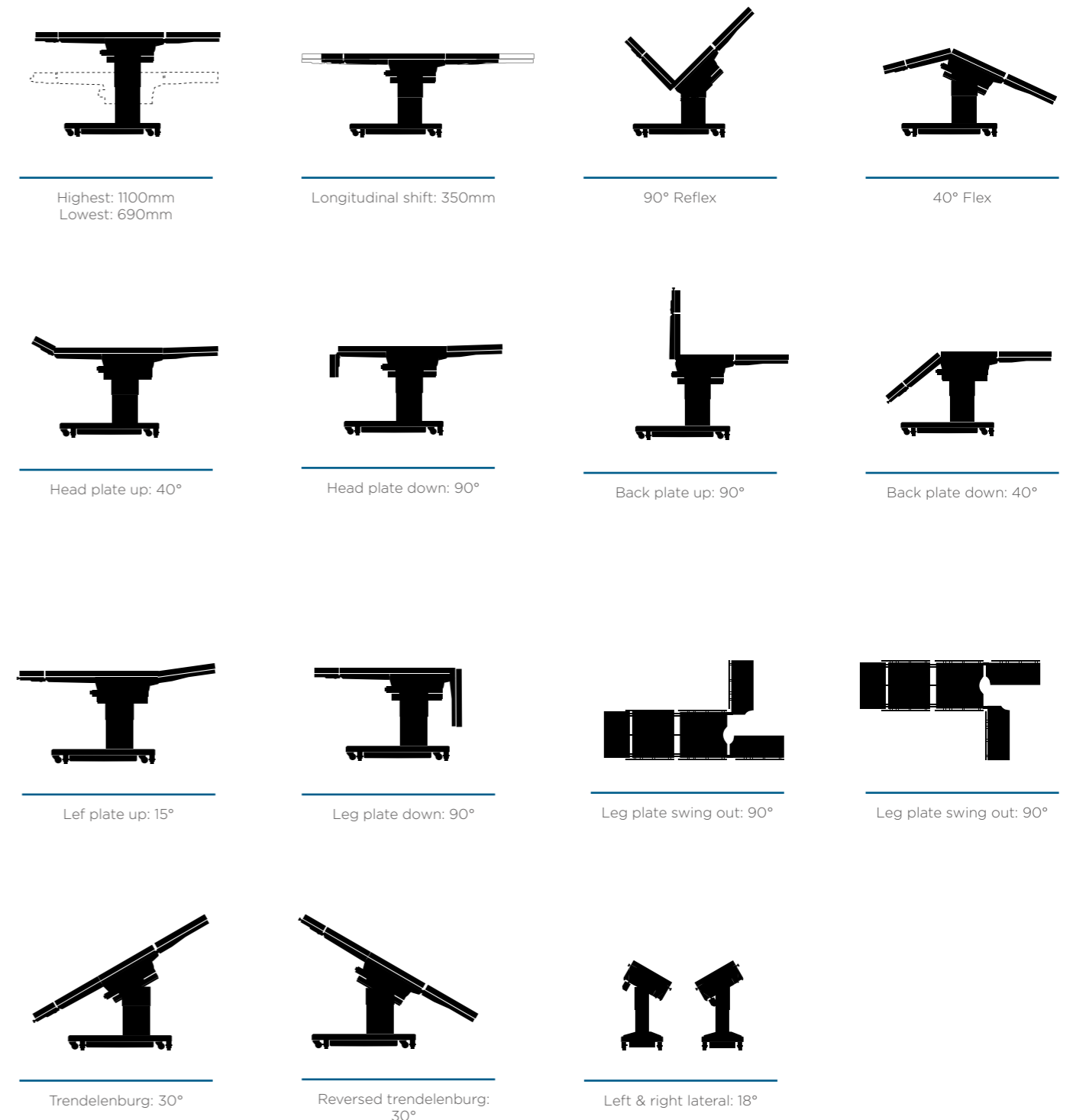



Applications in surgery

Various positions & accessories

<p>Hand support for lateral position surgery</p>	<p>Spine position holder for spondyle surgery</p>	<p>Anorectum surgery</p>
<p>Lateral position for kidney, cholecyst surgery</p>	<p>Leg supporter for gynaecological surgery</p>	<p>Supine position for orthopedics surgery</p>
<p>Supine position for orthopedics surgery</p>	<p>Tubia extension surgery</p>	<p>Tibia bone-nailing surgery</p>
<p>lateral leg supporter</p>	<p>E.N.T surgery</p>	<p>Laparoscopic adiposity surgery</p>

Orthopedics traction

more accessories, more applications

Easily installed and adjust, well explore the applications for surgery





Sliding Longitudinal shift function

The longitudinal shift could up to 300mm, best effect for compatible with C-arm without the need to repositioning or reverse positioning the table.



Electric system ensures the high performance and stable movements

Offer the most value in surgery and always keep the patient safe by its extremely stability

BIOT001E
Electric operating table



Design
Most efficiency and safe

- Intelligent electronic control system enables smooth movements
- Electric system with battery inside for any emergency cases
- 300mm horizontal sliding offers most versatile imaging capabilities
- The new carbon fiber table top ensures the high quality of imaging
- High quality table top ensure the capability for multi operations
- High class latex foam mattress to make sure the comfortable
- Side rails enable assembly various additional equipment
- Diversity accessories offer more convenience on operations
- High quality castors offer the transfer ability with central brake

BIOT001E
Electric operating table

Radiolucent
X-ray compatible plate

Thanks to X-ray compatible plate table platform, Our table could well allow for X-rays to be taken while the patient is still in the table. Optional Double layers platform could be chosen for holding x-ray film.



C-arm available



Superior materials for the frame and table top, first class working craft



Leg part swing out, up and down in any degree

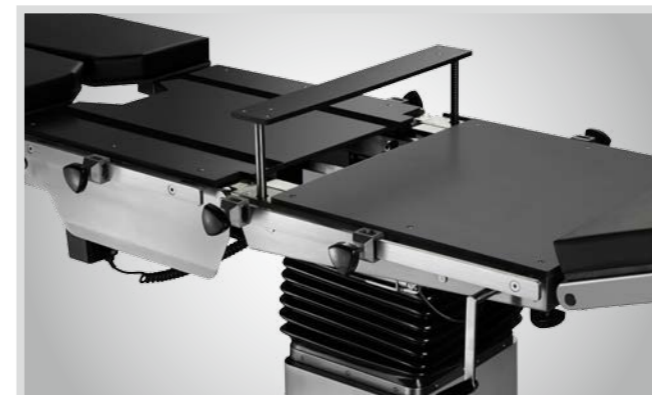

Kidney bridge elevation



High precision clamp with best workmanship

Movements Specifications

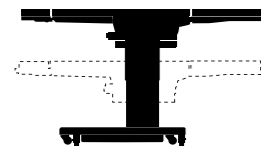

Highest: 1000mm
Lowest: 700mm



Longitudinal shift: 300mm



90° Reflex



40° Flex

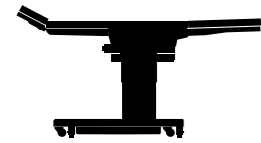

Head plate up: 40°

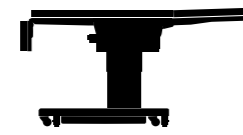

Head plate down: 90°

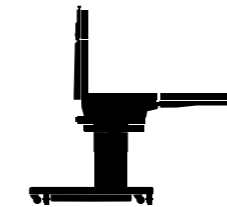

Back plate up: 90°

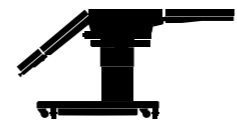

Back plate down: 20°

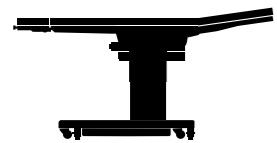

Lef plate up: 15°

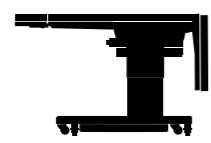

Leg plate down: 90°



Leg plate swing out: 90°

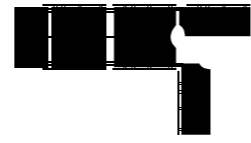

Leg plate swing out: 90°

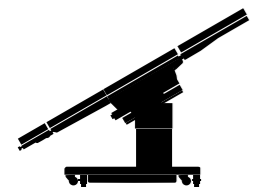

Trendelenburg: 25°

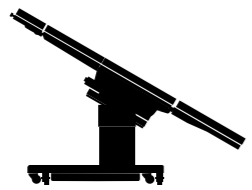

Reversed trendelenburg: 25°



Left & right lateral: 15°

Applications in surgery Various positions & accessories



Hand controller



central controller



Controls Highest standards

Highest standard for materials and accessories, big wheels for easy transfer
Most ergonomic design and durable structure, for long life using.



High quality mechanical system ensure the high performance. Quick and stable movements

First class materials, durable and reliable
Most convenient control switch and easy transfer

BIOT003M
Manual operating table

BIOT003M
Manual operating table



Top standards
Highest product safety and quality

Highest product safety and quality as the basis for quick and safe treatment of patients while providing good value for money in everyday use in hospitals.



Rear castor brake pedal, each castor has one, central brake operation

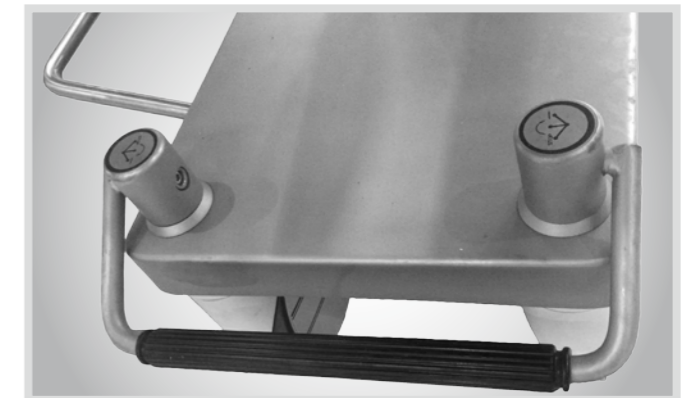

Front central brake pedal

Design
Highest product safety and quality

Outstanding quality for reasonable price, versatility and functionality ensure operational comfort for everyday surgical work. Together with wide range of additional accessories make it suitable for general and specialist surgical procedures. Adjustment possibilities and ranges meets the requirements demanded by a modern universal operating room.



Height adjustment control pedal, hydraulic



Gas spring control handle for back plate,

Radiolucent X-ray compatible plate

Thanks to X-ray compatible plate table platform, Our table could well allow for X-rays to be taken while the patient is still in the table. Optional Double layers platform could be chosen for holding x-ray film.



C-arm available

Movements Specifications

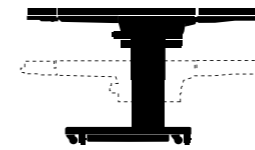

Highest: 970mm
Lowest: 670mm



Left & right lateral: 20°



Reverse trendelenburg



Trendelenburg

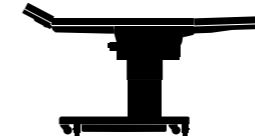

Head plate: up: 60°

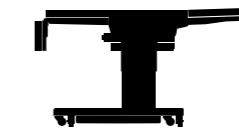

Head plate down: 75°

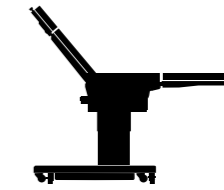

Back plate up: 70°



Back plate down: 30°



Leg plate up: 15°

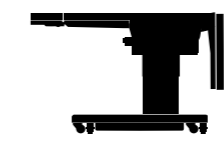

Leg plate down: 90°

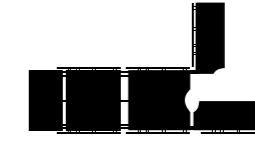

Leg plate swing out: 90°

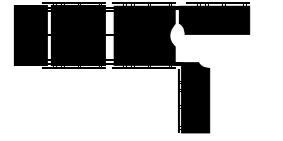

Leg plate swing out: 90°



Chair posture



Reflex posture

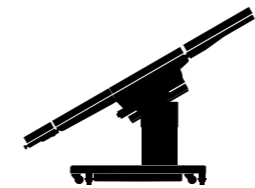

Trendelenburg: 30°



Reverse trendelenburg: 25°



90° Reflex



40° Flex

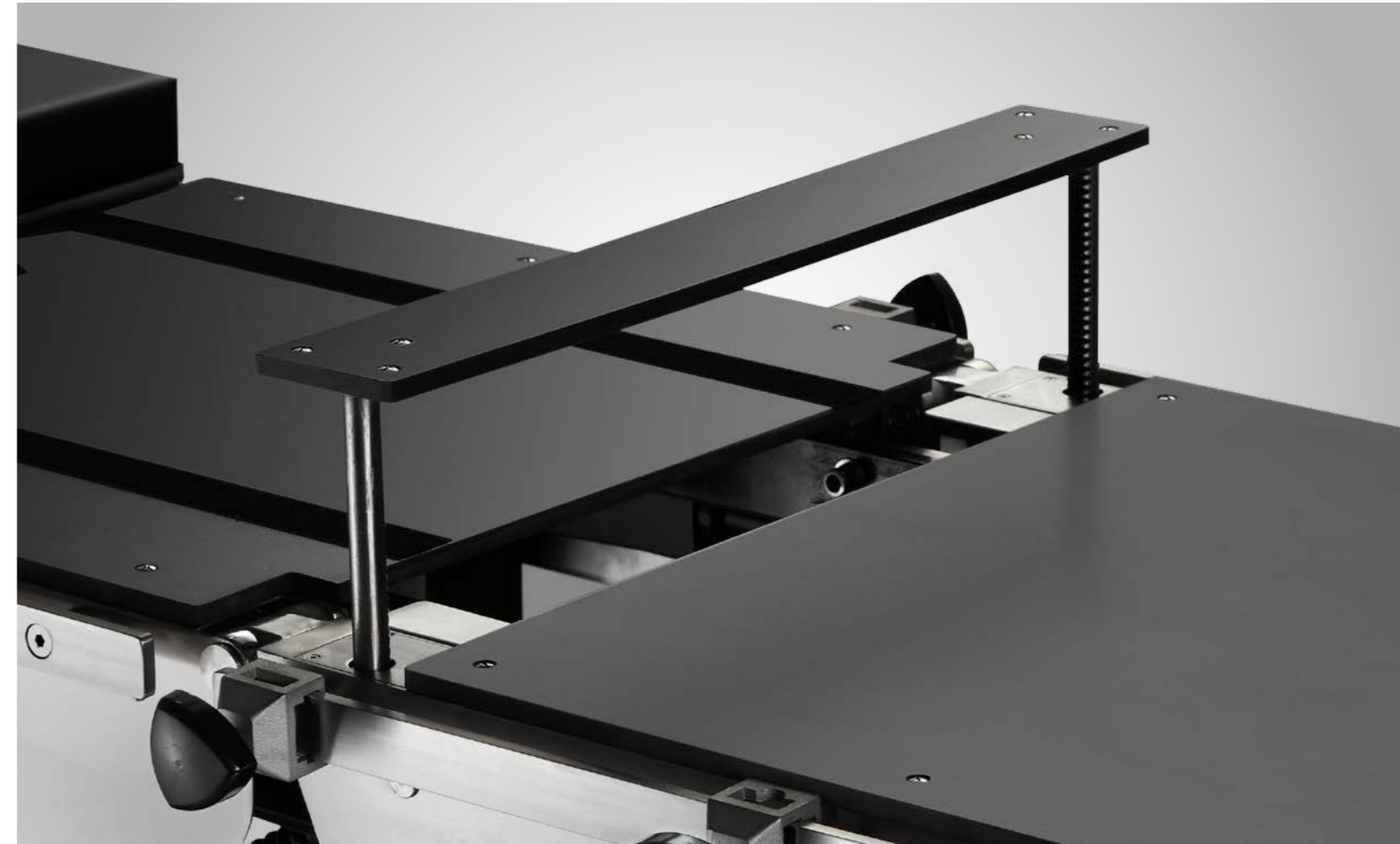

Controls Highest standards

Highest standard for materials and accessories, economic choice for general surgery

Most ergonomic design and durable structure, for long life using.



High quality mechanical system ensure the high performance. Quick and stable movements

First class materials, durable and reliable
Most convenient control switch and easy transfer

Product specification

Operating table

Specialist surgery

Ophthalmological purpose

Features	BIOT002EH	BIOT001E	BIOT003M	BIOT004M
Electro-hydraulic system	●	—	—	—
Electric system	—	●	—	—
Manual system	—	—	●	●
One button recovery	●	—	—	—
Longitudinal shift	●	●	—	—
Built-in battery	●	●	—	—
Single layer radiolucent table platform	●	●	●	●
Dual layers radiolucent table platform	○	○	○	○
Hand controller	●	●	—	—
Built-in central controller	●	○	—	—
Electric-hydraulic brake	●	—	—	—
Mechanical brake	—	●	—	—
Gas spring leg control	○	○	●	—
mechanical leg control	●	●	—	●
Kidney bridge	●	●	●	●
Main materials: 304 stainless steel	●	●	●	●

Accessories	BIOT002EH	BIOT001E	BIOT003M	BIOT004M
Anaesthesia screen frame	●	●	●	●
Shoulder support	●	●	●	●
Arm support	●	●	●	●
Hand support	○	○	○	○
Body support	●	●	●	●
Leg support	●	●	●	●
Foot support	●	●	●	●
Fluid basin	○	○	○	○
Orthopaedics traction frame	○	○	○	○
Spondyle operating support	○	○	○	○
Kidney bridge control handle	●	●	●	●
Memory mattress	●	○	○	○
Foam mattress	—	●	●	●
Power cord	●	●	—	—

Specifications	BIOT002EH	BIOT001E	BIOT003M	BIOT004M
Table length & width	1960x500mm	2070x550mm	2000x500mm	2080x480mm
Min. Height	690mm	700mm	670mm	790mm
Max. Height	1100mm	1000mm	970mm	1040mm
Horizontal Sliding	350mm	300mm	—	—
Trendelenburg	30°	25°	30°	25°
Reversed trendelenburg	30°	25°	25°	25°
Left lateral	18°	15°	20°	20°
Right lateral	18°	15°	20°	20°
Head plate up/down	40° /90°	45° /90°	60° /75°	30° /90°
Back plate up/down	90° /40°	75° /20°	70° /30°	90° /10°
Leg plate up/down	15° /90°	15° /90°	15° /90°	—/90°
Leg plate swing out	90°	90°	90°	90°
Kidney bridge elevation	110mm	110mm	120mm	120mm
Load capacity	250kg	250kg	250kg	250kg

● Standard features ○ Optional features — Cannot offer

BIOT005EH

Electro-hydraulic operating table



This table is specially designed for ophthalmological surgery, enhance the performance of doctor in surgery, offer patient more safety and stability.

Electro-hydraulic control for the height adjustment, reliable and stable, foot pedal for convenient operation.

Super lower height at 300mm offers more comfortable position for doctors, easy equip with various accessories to enhance the surgery effect.

Equip with high quality castors for easy transfer.

Table top: L2000mm x W530mm
Height adjustment: 300mm - 530mm

BIOT005M

Manual operating table



This table is specially designed for ophthalmological surgery, enhance the performance of doctor in surgery, offer patient more safety and stability.

Mechanical control for the height adjustment, reliable and stable, foot pedal for hydraulic pump to lift.

Super lower height at 240mm offers more comfortable position for doctors, easy equip with various accessories to enhance the surgery effect.

Equip with high quality castors for easy transfer.

Table top: L2000mm x W530mm
Height adjustment: 240mm - 530mm

Accessories

**Various accessories options,
fulfill any requirements for special surgery treatments**



Accessories

**Various accessories options,
fulfill any requirements for special surgery treatments**

